

# Electronics<sup>®</sup>

The promise of MOS memories: page 54

Designing FET front ends: page 62

Harnessing microwave acoustics: page 95

December 23, 1968

\$1.00

A McGraw-Hill Publication

Below: Electronics surveys  
European markets, page 65



## WEIGHING EUROPE'S 1969 PROSPECTS



# This New Pulse Generator Speaks for Itself

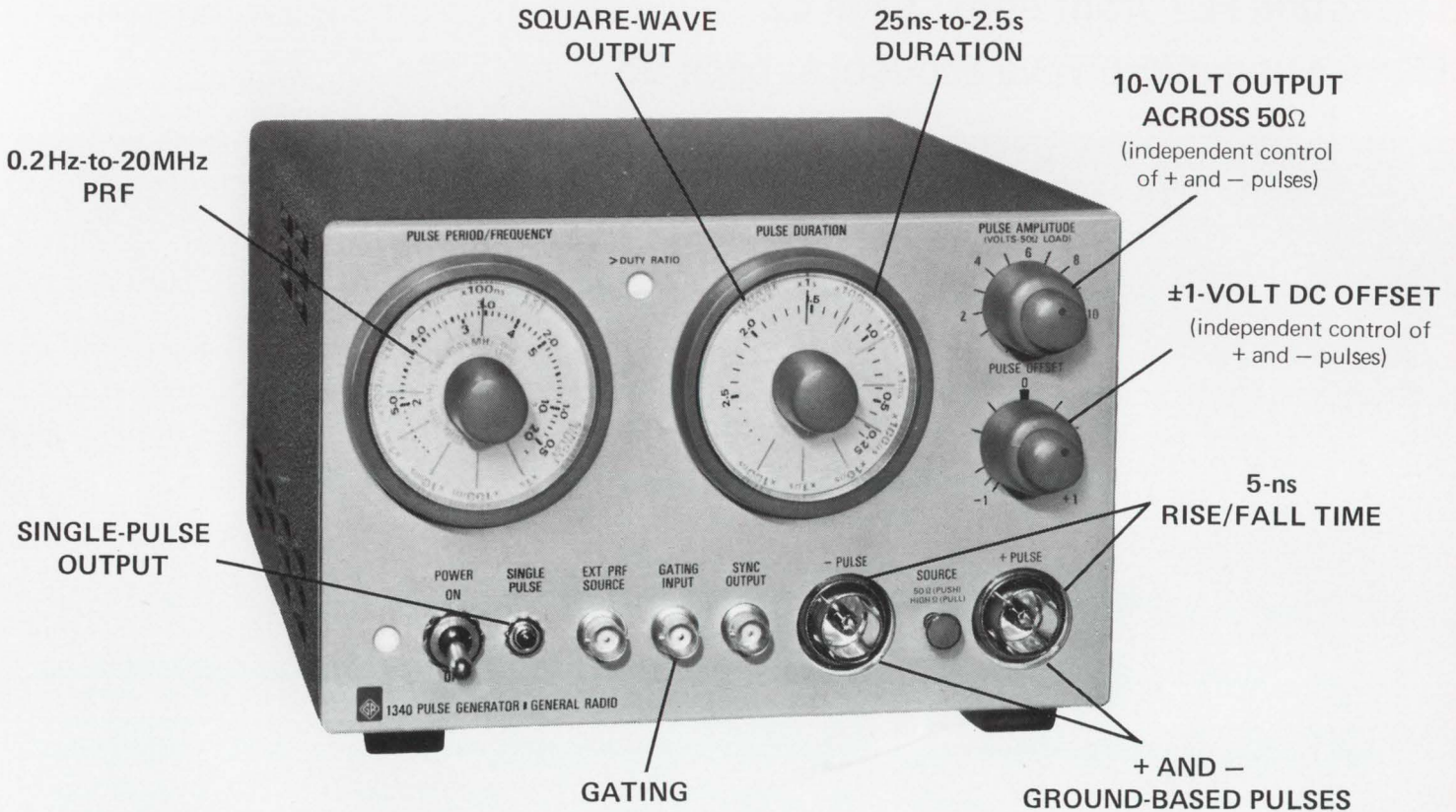

And It SHOUTS its price: **\$395.**

Need we say more?

For complete information, write General Radio Company, West Concord, Massachusetts 01781; telephone (617) 369-4400. In Europe: Postfach 124, CH8034 Zurich 34, Switzerland.

**GENERAL RADIO**



## A better V-F Converter? Look no farther.

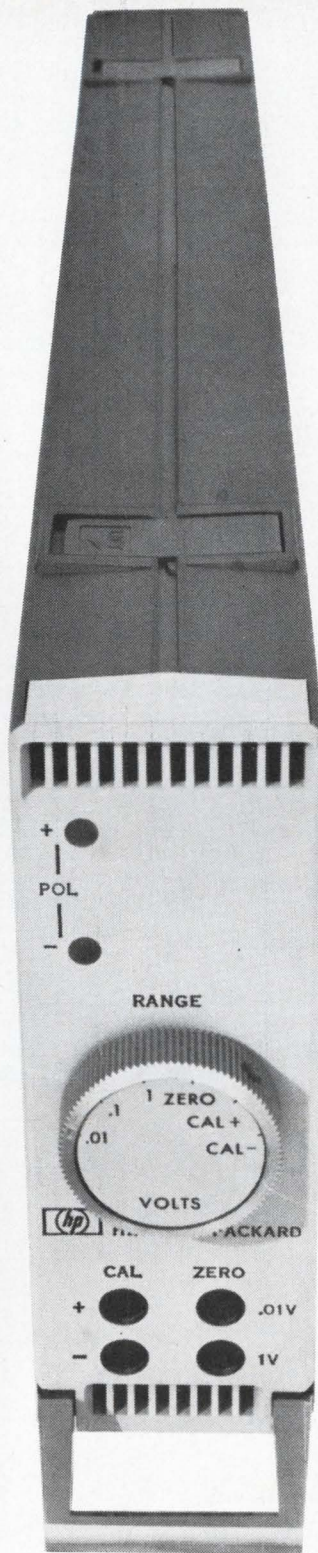

Take this voltage-to-frequency converter, couple it with your electronic counter—and you have a highly accurate low-level integrating digital voltmeter with high rejection of superimposed and common mode noise. Use it with counter remote start-stop signals to measure long term integrals. Use it with a preset counter and you can scale or normalize analog signals. Or integrate signals crossing zero with a reversible counter. Use two converters for ratio.

The Hewlett-Packard 2212A is more accurate, stable and linear, faster responding, smaller than any other V-F converter on the market. Input ranges down to 10 mV for 100 kHz output. Bipolar response with polarity output. 114 dB common mode rejection at 60 Hz. Internal calibration reference included. Use on the bench or install in combining cases; cases available to hold two or ten converters. Price, \$1100.

Call your local HP field engineer for complete specifications, or write Hewlett-Packard, Palo Alto, California 94304; Europe: 54 Route des Acacias, Geneva.

HEWLETT  PACKARD

06824



# Split personality

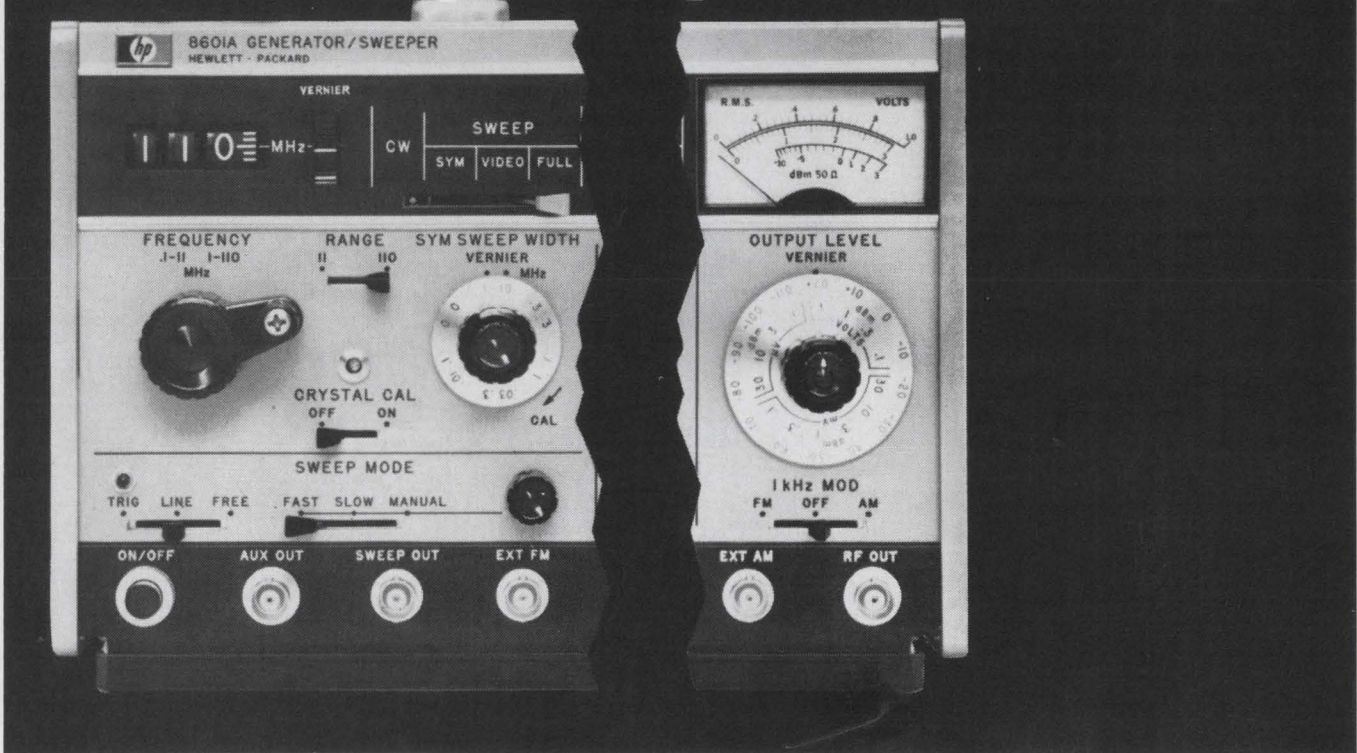

**This new Hewlett-Packard instrument can't decide if it's a wideband RF sweeper or a versatile signal generator. No wonder—it's both.**

Covering 100 kHz to 110 MHz, the HP 8601A Generator/Sweeper combines the high linearity and flatness of a precision sweeper with a signal generator's frequency accuracy and wide range of calibrated power levels. Though it's small and lightweight, it does the work of two instruments easily and conveniently.

As a sweeper, its 0.5% linearity and 1% frequency accuracy give you calibrated displays without having to use markers. Output flatness is  $\pm 0.25$  dB over the full range. Three sweep functions—full, video and symmetrical—let you shift from broad to narrow sweep with the flick of a switch. You can vary the sweep speed, fast enough for flicker-free display, slow enough

for high-resolution recording. And set the trigger for manual, line sync or free run.

As a signal generator, the 8601A output is accurate to  $\pm 1$  dB from +13 dBm to -110 dBm. The digital frequency dial is accurate to 1% of frequency; higher accuracy is achieved with 0.01% crystal checkpoints at 5 MHz intervals. Internal modulation is 1 kHz, AM or FM, or you can modulate externally.

The HP 8601A offers many more features that satisfy a wide range of lab and production requirements. Price: \$1975.

No sense developing a split personality yourself, struggling with several instruments. Let your HP field engineer give you complete details on how the HP 8601A alone can fill your RF sweeper *and* generator needs. Or write to Hewlett-Packard, Palo Alto, Calif. 94304; Europe: 54 Route des Acacias, Geneva.

HEWLETT  PACKARD

SWEEP SIGNAL GENERATORS

04809



## News Features

### Probing the News

- 95 **Advanced technology:** Microwave acoustics surfacing  
103 **Space electronics:** Loaded mission for ATS-F

### Electronics Review

- 37 **Solid state:** Laser encodes diode memory  
37 **Computers:** Details from a crt  
38 **Consumer electronics:** CBS unveils EVR; Reporting "breakthroughs"  
40 **Space electronics:** New Mars mission  
40 **Communications:** Regulating teleprocessing  
42 **Military electronics:** The Cains program; Getting the "feel" of the enemy  
44 **Avionics:** Talking by the numbers

### Electronics International

- 133 **Japan:** Electret capacitor microphone; glass fiber promises less signal loss; new Hitachi DECL IC's on prototype production line  
134 **Great Britain:** Electronic clock with no moving parts uses light for "hands"  
135 **West Germany:** Personal alarm system; high-speed camera setup provides flashes in nanosecond range  
136 **Around the world**

### New Products

- 109 Fast-computer market at stake in emitter-coupled-logic race  
110 R-f generator has digital readout  
115 **Microwave review**  
115 80-watt amplifier is broadband  
117 500-milliwatt impatt diode  
119 **Industrial electronics review**  
119 Converter digitizes 20 signals  
121 Line scanner detects hot spots

Title R registered U.S. Patent Office; © copyright 1968 by McGraw-Hill Inc. All rights reserved, including the right to reproduce the contents of this publication in whole or in part.

## Technical Articles

- Memory technology** 54 **MOS arrays come on strong**  
With their low power dissipation, the circuits can be densely packed on a chip; they promise to find a place in main storages and in read-only and associative memories, too, yielding to bipolars only when speed is essential  
William F. Jordan, Computer Control Division, Honeywell Inc.
- Circuit design** 57 **Designer's casebook**  
▪ Voltage regulator built from two AND gates  
▪ High-precision preamp built from three transistors  
▪ Simple method eliminates some inductors in filters  
▪ Two IC comparators improve threshold converter
- Consumer electronics** 62 **FET converter is self-oscillating**  
The problem of square-wave drain current has been solved by an agc-circuit that keeps the local oscillator's voltage level constant without clipping  
Daniel R. von Recklinghausen, H.H. Scott Inc.
- Marketing** 65 **European electronics markets: 1969**  
Forecasts of the equipment and components markets in 11 Western European countries
- 71 **It's got to be good**  
Electronics' editors and correspondents evaluate the trends in markets and technology in Western Europe
- |                   |                    |
|-------------------|--------------------|
| 72 West Germany   | 85 The Netherlands |
| 76 United Kingdom | 86 Belgium         |
| 79 France         | 87 Switzerland     |
| 81 Italy          | 88 Spain           |
| 83 Sweden         | 89 Denmark         |
|                   | 90 Norway          |

## Departments

- |                             |                              |
|-----------------------------|------------------------------|
| 4 Readers Comment           | 33 Electronics Newsletter    |
| 8 Who's Who in this issue   | 47 Washington Newsletter     |
| 14 Who's Who in electronics | 124 New Books                |
| 22 Meetings                 | 126 Technical Abstracts      |
| 31 Editorial Comment        | 128 New Literature           |
|                             | 131 International Newsletter |



# Electronics

Editor-in-Chief: Donald Christiansen

## Associate managing editors

**Technical:** Stephen E. Scrupski  
**News:** Robert Henkel  
**Copy:** Sally Powell

## Senior associate editors

Joseph Mittleman, Harry R. Karp

## Department editors

**Avionics & Space:** Alfred Rosenblatt  
**Computers:** Wallace B. Riley  
**Communications:** William Bucci  
**Components:** George Watson  
**Consumer electronics:** John D. Drummond  
**Design theory:** Joseph Mittleman  
**Industrial electronics:** Harry R. Karp  
**Military electronics:** Richard Gundlach  
**Special projects:** Raphael Kestenbaum

## Domestic bureaus

**Boston:** James Brinton, manager  
**Chicago:** Frederick Corey, manager  
**Los Angeles:** Lawrence Curran, manager  
**New York:** Howard Wolff, manager  
**San Francisco:** Walter Barney, manager; Peter Vogel  
**Washington:** Robert Skole, manager; Paul Dickson, William F. Arnold

## Foreign bureaus

**Bonn:** John Gosch  
**London:** Michael Payne  
**Tokyo:** Charles Cohen

## Copy editors

James Chang, Larry Miller

## Graphic design

**Art director:** Gerald Ferguson  
**Assistant art directors:** Valerie Betz, Susan Hurlburt  
**Production editor:** Arthur C. Miller

**Editorial secretaries:** Lorraine Longo, Claire Goodlin, Patricia Gardner, Barbara Razulis, Terry Kraus, Vickie Green

## McGraw-Hill News Service

**Director:** Arthur L. Moore; **Atlanta:** Fran Ridgway; **Chicago:** Robert E. Lee  
**Cleveland:** Arthur Zimmerman; **Dallas:** Marvin Reid  
**Detroit:** James Wargo; **Houston:** Barbara LaRoux  
**Los Angeles:** Michael Murphy; **Pittsburgh:** Louis Gomolak  
**San Francisco:** Margaret Drossel  
**Seattle:** Ray Bloomberg; **Washington:** Charles Gardner, Daniel B. Moskowitz, Herbert W. Cheshire, Seth Payne, Warren Burkett, William Small, William D. Hickman

## McGraw-Hill World News Service

**Bonn:** Robert Dorang; **Brussels:** James Smith; **Hong Kong:** Wes Perry;  
**London:** John Shinn; **Mexico City:** Gerald Parkinson; **Milan:** Ronald Taggiasco, Jack Star;  
**Moscow:** Jack Winkler; **Paris:** Robert E. Farrell, Stewart Toy  
**Rio de Janeiro:** Leslie Warren; **Tokyo:** Marvin Petal  
**Reprints:** Susan Nugent  
**Circulation:** Isaaca Siegel

## Publisher: Gordon Jones

**Electronics: December 23, 1968, Vol. 41, No. 26**

Published every other Monday by McGraw-Hill, Inc. Founder: James H. McGraw 1860-1948.

Publication office 99 North Broadway, Albany, N. Y. 12202; second class postage paid at Albany, N. Y.

Executive, editorial, circulation and advertising addresses: McGraw-Hill Building, 330 W. 42nd Street New York, N. Y. 10036. Telephone (212) 971-3333. Teletype TWX N.Y. 710-581-4235. Cable address: MCGRAWHILL N.Y.

Subscriptions solicited only from those professionally engaged in electronics technology. Subscription rates: qualified subscribers in the United States and possessions and Canada, \$8.00 one year, \$12.00 two years, \$16.00 three years; all other countries \$25.00 one year. Non-qualified subscribers in the U. S. and possessions and Canada, \$25.00 one year; all other countries \$50.00. Air freight service to Japan \$50.00 one year. Single copies: United States and possessions and Canada, \$1.00; all other countries, \$1.75.

Officers of McGraw-Hill Publications: Joseph H. Allen, President; J. Elton Tuohig, Executive Vice President; David J. McGrath, Senior Vice President-Operations; Vice Presidents: John R. Callahan, Editorial; Paul F. Cowie, Circulation; John R. Emery, Administration; John M. Holden, Marketing; David G. Jensen, Manufacturing; Jerome D. Luntz, Planning & Development; Robert M. Wilhelmy, Controller.

Officers of the Corporation: Shelton Fisher, President and Chief Executive Officer; John L. McGraw, Chairman; Robert E. Slaughter, Executive Vice President; Daniel F. Crowley, Donald C. McGraw, Jr., Bayard E. Sawyer, Senior Vice Presidents; John J. Cooke, Vice President & Secretary; Gordon W. McKinley, Vice President & Treasurer.

Title © registered in U.S. Patent Office; © Copyright 1968 by McGraw-Hill, Inc. All rights reserved. The contents of this publication may not be reproduced either in whole or in part without the consent of copyright owner.

**Subscribers:** The publisher, upon written request to our New York office from any subscriber, agrees to refund that part of the subscription price applying to copies not yet mailed. Please send change of address notices or complaints to Fulfillment Manager; subscription orders to Circulation Manager, Electronics at address below. Change of address notices should provide old as well as new address, including postal zip code number. If possible, attach address label from recent issue. Allow one month for change to become effective.

Postmaster: Please send form 3579 to Fulfillment Manager, Electronics, P.O. Box 430, Hightstown, New Jersey 08520

## Readers Comment

### Asking a recount

To the Editor:

Your special report on computer memories [Oct. 28, p. 103] was a most interesting and informative one on a complex, multifaceted subject. However, in the article entitled "Lower cost for longer words" [p. 115], there seem to be some glaring omissions and gross errors. I don't know whether the relative pricing curves on page 116 have been accurately reproduced, but just to set the record straight, I happen to know that Raytheon produces 900-nanosecond 2.5-D memories containing  $2^{14}$  (16K) words of 18 bits each for under 6 cents a bit, not the 17 to 18 cents per bit indicated in the chart.

In addition, it manufactures two-dimensional (Biax) memories of  $2^{12}$  (4K) words for less than 10 cents a bit, though the diagram indicates that 2-D thin-film memories don't reach that level until word capacity is extended to  $10^{16}$  (65K) words.

I suggest that you reevaluate the relative cost per bit axis of the chart and reprint it for the many people who will make reference to it.

James T. Samuelson  
Santa Ana, Calif.

▪ Reader Samuelson has misinterpreted the figures in the chart. The powers of two indicated on the curves refer to the total number of bits in the memory, not to the number of words. The Raytheon memories that Samuelson refers to contain 16,384 words of 18 bits each or slightly more than  $2^{18}$  bits; for a memory of this size, the chart shows the relative cost per bit to be about 4 cents—about the same figure Samuelson quotes.

He doesn't note the word length for the 2-D Biax memory. But in any case this comparison isn't valid because the curves for 2-D memories apply to thin films only.

### Straightening the lines

To the Editor:

I read the article by R.S. Singleton, "No need to juggle equations



Because most of the world is analog

# 2.8 MHz hybrid 10-bit D-to-A circuits are here to help.

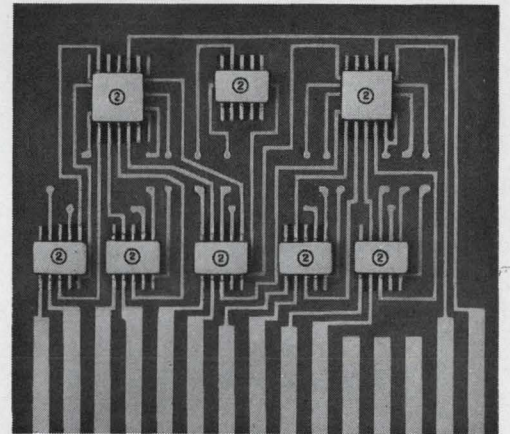

**Get 10-bit accuracy** at 2.8 MHz with only eight packages. You get ladder networks, ladder switches, and buffers. Just add a PC board and the fastest op amp you can find.

**Only 240 mW.** Save power. There's no hot speed/power trade-off with these new Sprague hybrids. And you save space, too. The D-to-A circuits are in  $\frac{1}{4}$ " x  $\frac{1}{4}$ "

and  $\frac{1}{4}$ " x  $\frac{1}{8}$ " hermetically sealed ceramic flatpacks, rated for  $-55$  to  $+125^{\circ}\text{C}$  operation.

**Three ways to go** for these new D-to-A circuits. Call Dom Consorte at Sprague Worcester—(617) 853-5000, ext. 321. Or call your nearest Sprague industrial distributor. Or circle the inquiry card number for complete specification data.

485-8150



'Sprague' and '®' are registered trademarks of the Sprague Electric Co.

**THE BROAD-LINE PRODUCER OF ELECTRONIC PARTS**



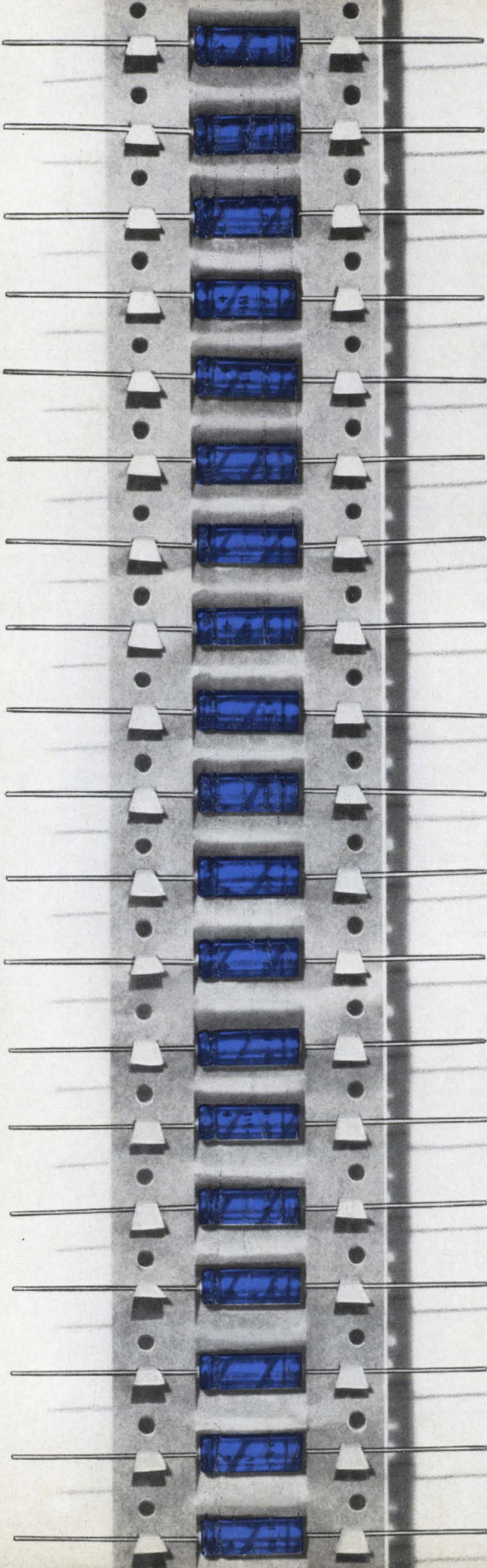

**Now...  
aluminum-cased  
electrolytics  
from a  
U.S. capacitor  
manufacturer...  
at prices  
competitive  
with the imports!**

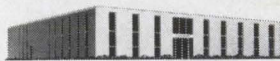

Amperex has the solution to the problem of delivering top-quality electrolytics at mass-produced prices in production quantities, from stock.

The solution is a brand new, million-dollar, fully-automated plant —right here in the U. S. A., in Hauppauge, New York.

Automation of production and quality control combined with a computerized order-processing system has resulted in meaningful mass-production economies. For the first time, you can get top-quality electrolytic capacitors, in production quantities, from stock, at prices competitive with the imports.

Through the use of ultra-high-purity etched foil and associated electrolyte . . . plus an exclusive double-cathode tab construction, we are producing the highest CV-product-per-can-size available.

Sealed in aluminum cans and insulated with the famous "Amperex blue" polyester sleeves, Amperex dry electrolytics operate efficiently from  $-40^{\circ}\text{C}$  to  $+85^{\circ}\text{C}$ . No other line, domestic or imported, offers the Amperex combination of smaller size, higher performance, lower leakage and higher stability.

Amperex electrolytic capacitors are available in a wide range of capacitance and voltage ratings in both axial lead and vertical configurations. They are packaged to suit the requirements of the user . . . in oriented bulk or "ammo-pack."

For more information, write: Component Division,  
Amperex Electronic Corporation, Hauppauge, New York 11787.

**Amperex<sup>®</sup>**

TOMORROW'S THINKING IN TODAY'S PRODUCTS



## Readers Comment

to find reflection—just draw three lines” [Oct. 28, p. 93] with much interest, but I found an erroneous instruction for drawing lines to obtain a graphical solution. On page 94, the author writes, “From this point the engineer draws a line at right angles to the sending-end line and follows it until. . .” To be correct the line to be drawn must have a slope that’s the negative of that of the transmission line. All additional lines should have the slope of the transmission line or its negative.

On page 96, the author uses the principle of superposition to analyze a transmission line terminated by a diode with the driving function of a rectangular pulse. The approach is not valid because of the nonlinearity of the diode. This seems to account for the poor correlation between the graphical solution and the photograph of the oscilloscope trace.

Hiroshi Amemiya

RCA Electronic  
Components Division  
Somerville, N.J.

▪ Author Singleton replies: “The instruction accompanying the plot on page 94 is indeed an unfortunate error. The correct procedure is as reader Amemiya indicates and is explained in the text of the article on page 95 and again on page 99. As for the other point raised, although superposition is based on linear relationships, its use in this example is appropriate because the diode chosen has a nearly linear voltage-current curve.”

### V<sub>EE</sub> formation

To the Editor:

The article on Motorola’s “super-ECL” [Oct. 14, p. 124] is of great interest in that it combines both performance and packaging information. It’s necessary to alert designers to the new mechanical requirements imposed by advanced circuit technology.

The top and bottom sketches on page 127 should indicate a terminal for V<sub>EE</sub> on the cold plates. In the photograph, the V<sub>EE</sub> connection can be made by a jumper wire from each stud to the printed board.

David S. Walker

Sperry Gyroscope Division  
Sperry Rand Corp.  
Great Neck, N.Y.

### Handle with care

To the Editor:

The toxicity of thallium compounds was the subject of a recent letter [Oct. 28, p. 7] that labeled ingestion or inhalation as the critical area of toxicity.

In addition to these hazards, though, there is the problem of skin contact. Thallium, like lead, forms water soluble compounds, some of which can be absorbed through the skin. In view of the cumulative nature of thallium, persons handling this metal or its compounds should wear rubber gloves.

Dr. D. F. Stoneburner

Research & Development Center  
Westinghouse Electric Corp.  
Pittsburgh

# new AC/BATTERY

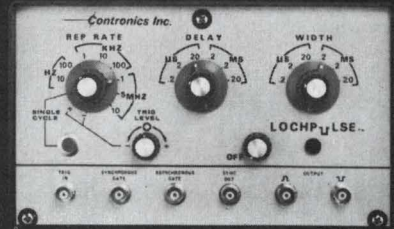

## PULSE GENERATORS

Contronics CPG200 Series  
Completely Self Contained  
Laboratory and Portable Pulse  
Generators with—

100% DUTY CYCLE

6 ns RISETIME & FALLTIME

SIMULTANEOUS  
COMPLEMENTARY OUTPUTS

1 Hz TO 10 MHz REP RATE

A/C-BATTERY

VARIABLE DELAY & WIDTH

SIZE—HALF RACK

WEIGHT 6 LBS.

FROM \$310.00

DELIVERY FROM STOCK

The CONTRONICS CPG200 Series provides a new dimension in pulse generators. It is the only low cost solid state, portable pulse generator series specifically designed for use with integrated circuits.

International  
**Contronics Inc.**

1061 Terra Bella Avenue  
Mountain View, California 94040  
(415) 969-0793 TWX 910-379-6976

### SUBSCRIPTION SERVICE

Please include an Electronics Magazine address label to insure prompt service whenever you write us about your subscription.

Mail to: Fulfillment Manager  
Electronics  
P.O. Box 430  
Hightstown, N.J. 08520

To subscribe mail this form with your payment and check  new subscription  renew my present subscription

Subscription rates: qualified subscribers in the U.S.: 1 year \$8; two years, \$12; three years, \$16. Non-qualified: 1 year \$25. Subscription rates for foreign countries available on request.

### CHANGE OF ADDRESS

ATTACH  
LABEL  
HERE

If you are moving, please let us know five weeks before changing your address. Place magazine address label here, print your new address below.

name

address

city

state

zip code



# NEED MORE POWER?

## TELONIC'S PD-B SWEEP GENERATORS PUT OUT A WILD .054 H.P. (40 WATTS).



- 20-1000 MHz
- Oscillator Overload Protection
- Swept or CW
- Birdy By-Pass Markers

Telonic High-Performance PD-B Sweep Generators are available in 4 Models.

MODEL	PD-2B	PD-3B	PD-7B	PD-8B
Center Freq., MHz	20-100	100-250	200-375	375-1000
Sweep Width	0.2-15%	0.2-15%	0.2-10%	0.2-15%
Max. Output	40 watts			
Min. Levelled Swept RF Output	8 watts			
Flatness	± 0.5 dB with internal leveling			
Attenuation	0-59 dB in 1 dB steps			
Linearity	1.2:1			

If you want complete specifications and descriptions, send for New Product Data Sheet #81.



**TELONIC INSTRUMENTS**  
 A Division of Telonic Industries, Inc.  
 60 N. First Avenue • Beech Grove, Indiana 46107  
 TEL (317) 787-3231 • TWX-810-341-3202

### Who's Who in this issue



Erikson

A six-week swing through 11 West European countries by our Electronics Abroad editor, Arthur Erikson, was the genesis of the market report that begins on page 65. On his peregrinations, Erikson gathered the raw statistical materials from knowledgeable European marketing people. The profiles of the national markets were put together from reports by Electronics' European correspondents.

For the cover photo, Erikson joined art director Jerry Ferguson in a 20-cent junket from Electronics' offices in mid-town Manhattan to one of the most "European" locales anywhere—a fruit shop run by an aria-singing tenor in Greenwich Village's Bleeker Street.

"The huge investment in LSI will eventually lead to lower-cost and higher-speed memories," says William F. Jordan Jr., author of the article on p-channel MOS memory arrays on page 54. Jordan, engineering section manager for semiconductor memory products at the Computer Control division of Honeywell Inc., believes his ex-



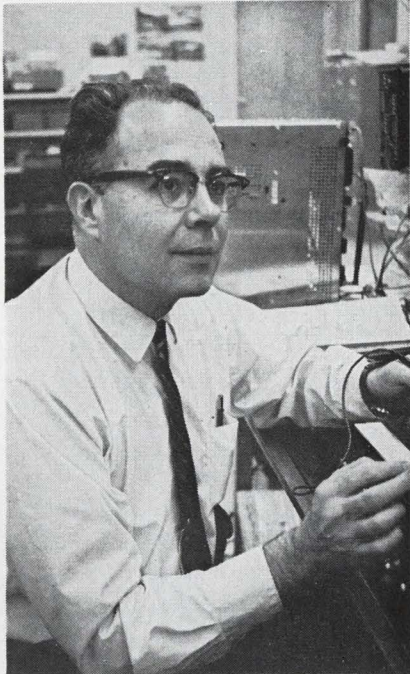

von Recklinghausen

Improved audio equipment has always been the professional goal of Daniel R. von Recklinghausen, author of the article on FET front ends on page 62. The New York-born von Recklinghausen joined H.H. Scott Inc. in 1951 as a project engineer responsible for the development of sound analyzers, tuners, amplifiers, and other acoustical equipment. In 1955 he assumed his present post as chief research engineer. Before joining Scott, he worked for Rohde & Schwartz in Munich and at the electronics research laboratory of the Massachusetts Institute of Technology, where he worked on the development of reverberation devices and recording and studio gear.

perience with devices, circuits, and systems at the now-defunct semiconductor division of CBS and the R&D division of the Avco Corp. has helped him in analyzing the problems of memory design. He has also worked on a ferrite-core memory system with all-integrated peripheral circuits. For relaxation, he takes in the New England shore.

## New from Sprague Electric!

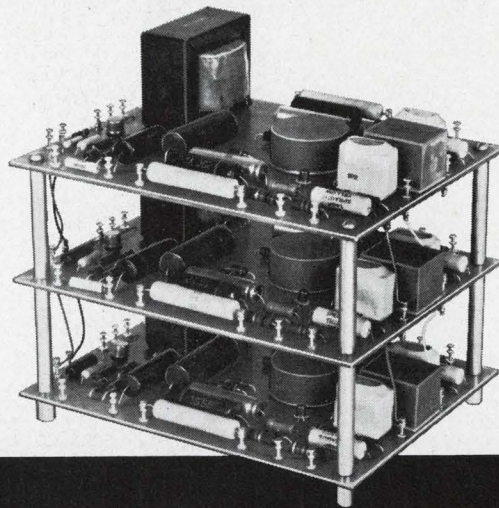

**Lower-cost SCR trigger packages  
with higher gate pulse power!**

### **Sprague PHASETROL® Series VPH gives you solid state reliability**

- ✓ Pulse rise time in 100-150 nanosecond range (typical)
- ✓ Single- or three-phase operation at 3 input voltage ratings
- ✓ Reduced noise . . . improved transient protection
- ✓ One or two outputs per phase
- ✓ 3° firing match typical in three-phase packages
- ✓ Non-magnetic . . . fast response time . . . no transportation lag
- ✓ Half- or full-wave designs
- ✓ Pulse lock-out feature
- ✓ One input, external signal mix
- ✓ Hard firing . . . 20 volts peak, 2.0 amperes

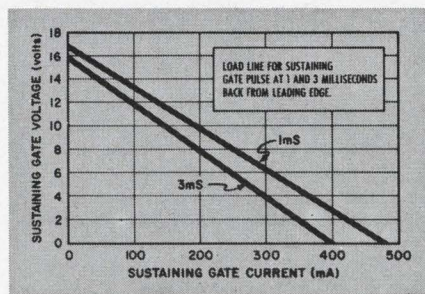

For complete technical data, write for Engineering Bulletin 86010 and Technical Paper 66-1 to the Technical Literature Service, Sprague Electric Company, 35 Marshall Street, North Adams, Massachusetts 01247.

#### SPRAGUE COMPONENTS

PULSE TRANSFORMERS  
CAPACITORS  
TRANSISTORS  
RESISTORS  
THIN-FILM MICROCIRCUITS  
INTEGRATED CIRCUITS

INTERFERENCE FILTERS  
PACKAGED COMPONENT ASSEMBLIES  
FUNCTIONAL DIGITAL CIRCUITS  
MAGNETIC COMPONENTS  
CERAMIC-BASE PRINTED NETWORKS  
PULSE-FORMING NETWORKS

**SPRAGUE®**  
THE MARK OF RELIABILITY

Sprague and ® are registered trademarks of the Sprague Electric Co.



# Our apologies to anyone who just

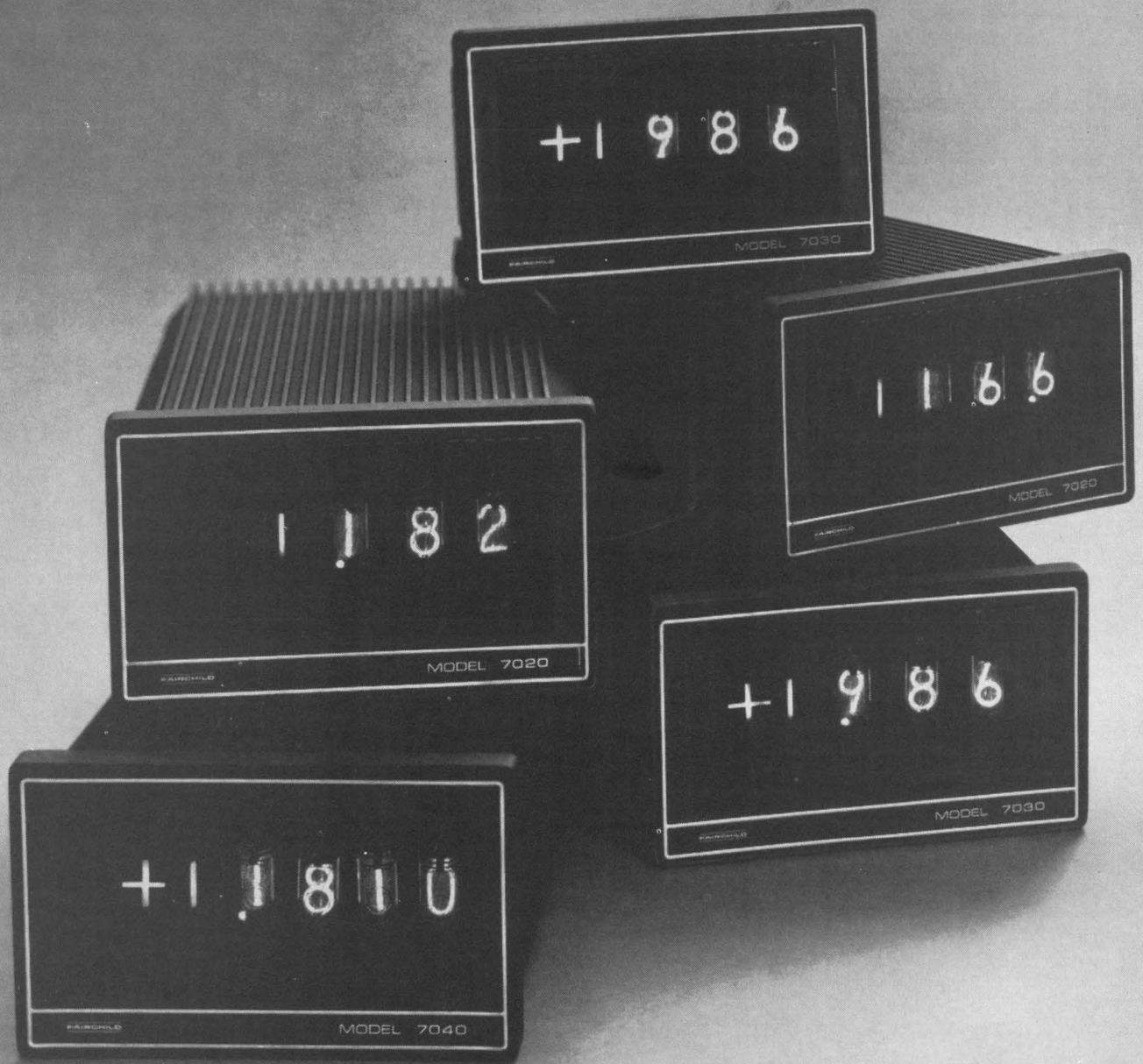



# bought an analog panel meter.

You can now get a much greater value: a digital panel meter from Fairchild Instrumentation. Each Fairchild meter gives your system higher resolution, higher accuracy and computer compatibility. And they're all priced to let you upgrade your military, medical or process control systems economically.

The Fairchild meters are essentially digital voltmeters using dual slope integration. Performance is an order of magnitude better than the best analog meters on the market.

Our Model 7020 is a three-digit, single range, single polarity meter. It covers any one of five input ranges from 150mV to 1000V full scale. It only costs \$230 when you buy quantities of 25 or more.

Model 7030 has three digits and an overrange bit. It handles input ranges from 199.9mV to 1000V full scale. The price is \$251 each for 100 or more.

The top of our line is model 7040. It reads out to four digits plus an overrange bit. Input ranges go from 1.2000V to 1000.0V full scale. It costs \$435 in quantities of 100.

Remote read-outs are available for Models 7030 and 7040. They cost \$100 and \$125, respectively.

Delivery is 30 days for any model. Call us now for complete details or experienced applications assistance.

Fairchild Instrumentation / A Division of Fairchild Camera and  
**FAIRCHILD** Instrument Corporation / 974 E. Arques Ave., Sunny-  
INSTRUMENTATION vale, Calif. 94086 / (408) 735-5011 / TWX: 910-339-9217.



# THE STRONGEST EUROPEAN GROUP IN SOLID STATE DEVICES HAS GEARED ITS CAPABILITIES TO YOUR **ic** REQUIREMENTS

## DESIGNING DIGITAL SYSTEMS?

Choose from one of Philips' three digital IC 'families'; each one has been designed to give you optimum performance in a popular speed range - medium, high, or ultra-high.

### DTL FC FAMILY

(COMPATIBLE WITH THE 200 SERIES)

A most comprehensive monolithic family, giving unparalleled performance in medium-speed applications. It includes single and multiple gates (with or without collector resistor), an expander, a level detector, monostable, single and dual JK flip-flops, besides more complex elements such as a parity checker, comparator, 4-bit decoder, and quad latch flip-flop. Propagation delay is around 30 ns. Noise margin at 25°C is 1.2 V, and fan-out is 8 at all temperatures. A single 6 V supply is used. Standard encapsulation is all-plastic DIL. Hermetic DIL or flat pack are also available on request.

### TTL FJ FAMILY

(COMPATIBLE WITH THE 74N SERIES)

Designed for high-speed applications. A versatile range of gates, from single eight-input to quadruple dual-input gates, AND-OR-NOT gates, as well as expanders, single and dual flip-flops, besides more complex elements like a decade counter. Propagation delay is around 13 ns; noise margin is 1 V at 25°C; fan-out is 10; and driving into capacitive loads is excellent. Operation is from a 5 V supply. Standard encapsulations are all-plastic and hermetic DIL. Flat pack is also available on request.

### TTL FH FAMILY

(COMPATIBLE WITH THE SUHL II)

Operating at the highest switching speeds, these circuits outstrip any other range in performance. Single to quadruple gates, expanders, AND-OR-NOT gates, and flip-flops are all included. Propagation delay is around 6 ns; noise margin is 1 V; and there are two fan-out types, with a maximum of 5 and 9 respectively. Operation is from a 5 V supply. Standard encapsulations are all-plastic and hermetic DIL. Flat pack is also available on request.

## WE OFFER FULL DIGITAL CAPABILITY!

- We design higher-order circuits for large-volume requirements, compatible with any one of our digital families.
- We can make ultra-high-speed current-mode logic in the 2 to 3 ns range to suit your needs; emitter-emitter coupled logic, for example.
- We have a well-established process for making complex MOS circuits with excellent performance throughout life.
- We achieve high noise immunity with digital circuits. Our 12 V circuitry has a noise margin of 5 V, and a speed of several hundred ns.

# PHILIPS



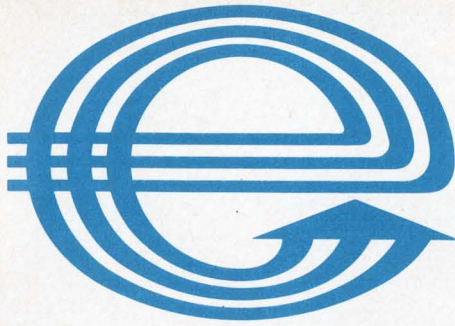

## ..... PRODUCTS ARE ONLY PART OF THE DEAL

When you buy from Philips you get all the benefits of dealing with a world-wide organization having vast research, development and production resources. The Philips organization grew up with electronics. Today it has unrivalled experience in mass-producing a wide range of electronic components — your guarantee of consistent quality and performance. But dealing with Philips means more. Our applications laboratories in many countries employ specialized engineers to help you

put Philips integrated circuits to work in your equipment. Service is no problem; we guarantee the supply of standard integrated circuit types for ten years after their introduction. All this is backed up by our technical information service — a continuous flow of publications keeping you up-to-date with the latest developments in integrated circuits and their applications. We are represented in almost every country. Wherever you are, Philips 'stand-by' service cannot be far away! You buy far more than just integrated circuits when you buy Philips. With Philips, products are only part of the deal!

## USING LINEAR CIRCUITS?

*Philips linear circuits are all designed with a specific application in mind — that's why their specifications are always 'just right' for the system designer. The range includes circuits for black-and-white TV, colour TV, radio, audio, hearing-aids, communications, and instrumentation. Look at these, for instance:*

### TAA300

A unique 1 W thermally compensated class-B audio output amplifier. It requires no external impedance matching resistors and no output transformers. Its current drain is only 8 mA from a 9 V battery, and it works with less than 10% distortion even with battery voltage variations of more than 2:1. Only 10 mV drive is needed for full 1 W output into a standard 8  $\Omega$  speaker. In 10-lead TO-74 envelope.

### TAA320

Another original audio pre-amplifier circuit, which combines a MOS FET input transistor with a bi-polar output on a single chip. Its input impedance is at least 100 G $\Omega$ . Should you need a lower input impedance, there is also the TAA310. The TAA320 comes in a 3-lead TO-18 envelope. The TAA310 is supplied in a 10-lead TO-74 envelope.

### TAA450

This circuit forms a complete FM IF amplifier, limiter, ratio detector, and audio pre-amplifier with 2 V (peak-to-peak) output for driving tube or semiconductor circuitry. Another circuit, the TAA570, is available with a simple quadrature detector and an audio pre-amplifier section. The TAA450 is supplied in a 10-lead TO-74 envelope. The TAA570 comes in a variant of the 10-lead DIL envelope.

### TAA500

A unique audio amplifier circuit with a common output and D.C. supply line. Operation is from a current source of between 20 mA and 100 mA, and constant voltage gain is 300 over the full supply range. With an external load of 100  $\Omega$  it allows the use of ceramic piezoelectric transducers in circuits designed for carbon microphones. Can be used with dynamic microphones. Applications include mobile transmitters, aircraft communications, and telephone circuits. In 4-lead TO-12 envelope.

### TAA550

Designed specifically for TV tuners using varactor diodes, this device out-performs any stabilizing circuit employing discrete components. It stabilizes a 33 V supply with a temperature coefficient of 50 p.p.m./ $^{\circ}$ C. Contained in a 2-lead TO-18 envelope.

## LET PHILIPS' LINEAR KNOW-HOW WORK FOR YOU!

There are many more Philips linear circuit configurations:

- Two hearing-aid amplifiers, using a 1.3 V battery supply, giving 0.2 mW (OM200) and 1 mW of output (TAA370) respectively.
- Two general-purpose three-stage amplifiers (TAA263 and TAA293).
- An operational amplifier (TAA241) equivalent to the 702.
- A ring modulator circuit (TAB101) for carrier system telephony.

We are working on still more linear circuit possibilities; for example, a MOS divider circuit for electronic organs, a TV signal processing circuit, a synchronous demodulator and RGB matrix for colour TV.

Talk over your IC needs with Philips. We are ready to work with you!

PHILIPS ELECTRONIC COMPONENTS AND MATERIALS DIVISION - EINDHOVEN, THE NETHERLANDS

distributed and sold in the U.S. by: **AMPEREX ELECTRONIC CORPORATION** Providence Pike, SLATERSVILLE, Rhode Island  
230 Duffy Avenue, HICKSVILLE, New York 11802 • 801 E. Charleston Avenue, PALO ALTO, California 94303 • 360 E. North Avenue, NORTHLAKE, Illinois 60164.



## Who's who in electronics

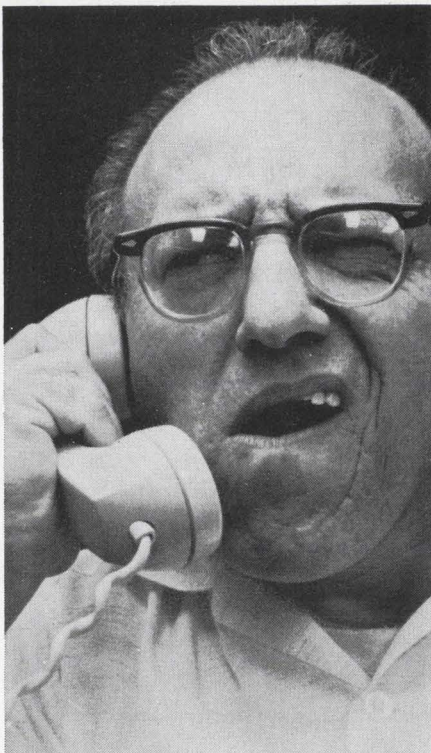

**"Four to six weeks for power supply delivery?**

**Forget it!**

**Acopian will ship any of their 62,000 different AC to DC plug-in power supplies in just 3 days!"**

This catalog lists 62,000 models of AC to DC plug-in power supplies available for shipment in just three days. Choose the exact outputs you need. Singles or duals, regulated or unregulated. Write or phone for your free copy.

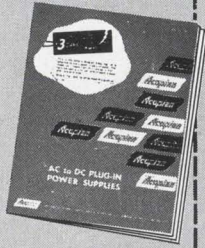

Name \_\_\_\_\_

Title \_\_\_\_\_

Company \_\_\_\_\_

City \_\_\_\_\_

State \_\_\_\_\_

Zip \_\_\_\_\_



Acopian Corp., Easton, Penna. 18042  
Phone: (215) 258-5441

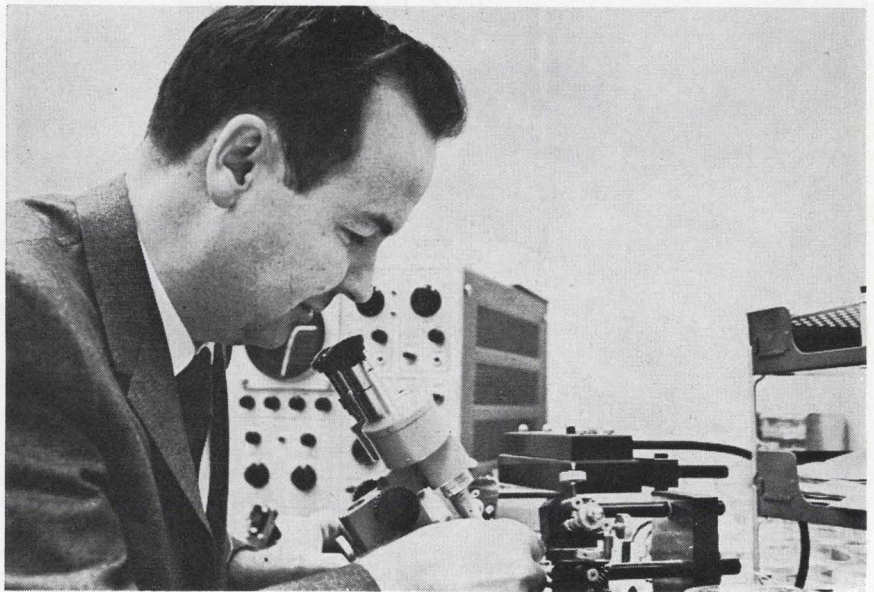

Seely

**"MOS is fun.** In the past, however, we've disappointed our customers. Our engineers love to tell our customers all the tricks they can perform with the technology, but when it comes to delivering reliable devices on time and in quantity, it's a different story." This is how J. Leland Seely, the new general manager of General Instrument's Microelectronics division, assesses the problems that have plagued the division up to now. Seely succeeds John Paivinen, who suddenly resigned from GI this month.

Seely's remedy is simple enough: narrow the scope of GI's product line to fewer and better circuits. Initially, the company will concentrate on its high-volume custom circuits that it already supplies to such firms as RCA, National Cash Register, Collins Radio, and others. The division will also zero in on a standard line of low-voltage MOS shift registers, multiplexers, and 256-bit random access read-write memories.

Another product likely to get a lot of attention is its 2,000-bit read-only memory.

According to Seely, it will take Microelectronics about three months to drop some of its less profitable business and really begin to concentrate on its goals.

**Systems go.** MOS at GI "has been four years in coming. Now we're really ready to take off," he adds. Indeed, he should know, because it was Seely and several others who, four years ago, convinced GI chief executive officer Moses Shapiro to throw the firm into MOS.

Along with narrowing the product line, Seely says he will also try to coordinate the efforts of the four groups—Los Angeles, Hicksville, N.Y., Salt Lake City, and Glenrothes, Scotland—that make up the Microelectronics division. He concedes that the efforts "have been less than coordinated up to now.

"We have, potentially, three times the power in MOS as any other house. But due to internal problems we haven't been using anywhere near that amount up to now."

**The FCC sponsors** some fine "paper studies" of communications problems, but it rarely finds time and funds to implement the results. Now, however, in Raymond E. Spence, the Federal Communications Commission has a new deputy chief engineer who hopes to get the recommended remedies off



# Koldweld's multiple upset removes impurities from the weld zone... without heat.

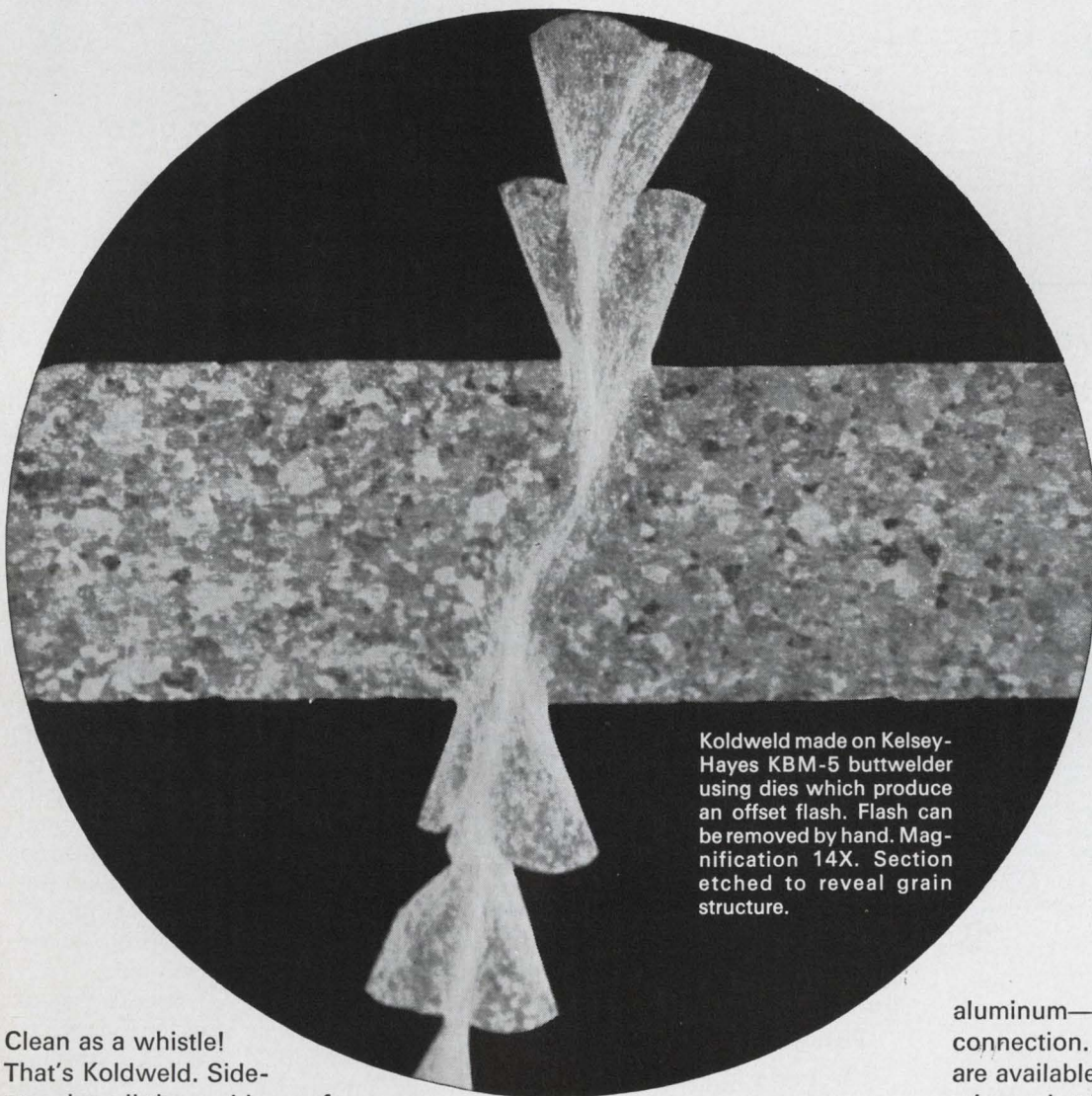

Koldweld made on Kelsey-Hayes KBM-5 butt welder using dies which produce an offset flash. Flash can be removed by hand. Magnification 14X. Section etched to reveal grain structure.

Clean as a whistle!  
That's Koldweld. Side-stepping all the problems of heat, Koldweld gives you no annealing, crystallization or weakening. Koldweld produces a perfect metallurgical and mechanical butt weld in non-ferrous metals in seconds—with pressure alone. It welds bare and tinned wire down

to .010" diameter with exact end-to-end alignment. With many materials Koldweld makes welds that are actually stronger than the parent metals because of intermolecular fusing of the metals. It is, for example, the best way to weld copper to

aluminum—making a fast, sure connection. Koldweld machines are available for a wide range of wire and strip sizes. For complete information, write KOLDWELD, Heintz Division, Kelsey-Hayes Company, Front Street & Olney Avenue, Philadelphia, Pa. 19120.

**KH**  
HEINTZ DIVISION · KELSEY-HAYES



# Lapp Entrance Insulators

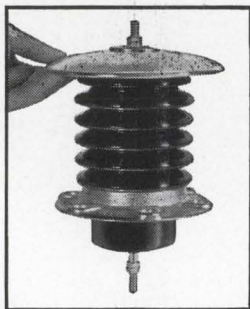

The sizes vary...  
But our skills are always large.

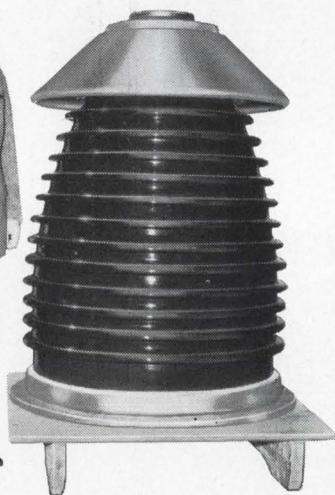

Lapp skill in designing and building entrance insulators goes back over 43 years. We're big on design knowledge, ingenuity and ability to deliver the job . . . right to your requirements.

Standard designs, or special types, Lapp can produce entrance insulators for almost every electrical and mechanical requirement. Save your company time, money and searching . . . call in Lapp when your projects require entrance insulators, or antenna, or tower insulators.

Put Lapp skills to work for you . . . from design to delivery. Lapp Insulator Co., Inc., LeRoy, N. Y.

**Lapp**

## Who's Who in electronics

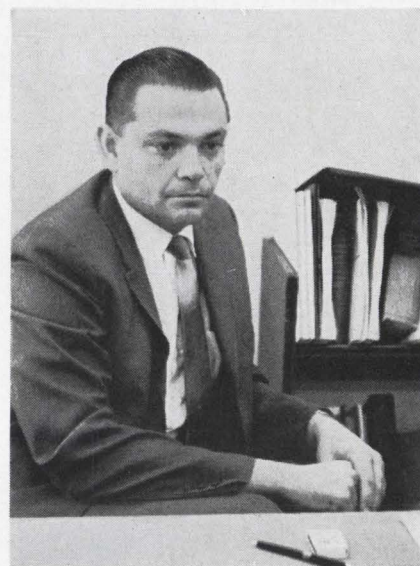

Spence

paper and out into the field considerably faster.

To this end, Spence plans to try to beef up the FCC's currently rather lackluster research and development program. He feels strongly that the commission should be on top of technical developments. "A regulatory agency can't be very effective if all it can do is react to a de facto situation. We can do a better job if we can guide technical developments rather than come in at the last moment and slap on some rules," he says.

**Down to earth.** Spence, who comes to the FCC from the Federal Aviation Administration, where he headed the voice communications systems branch, will also be responsible for evaluating and testing some of the recommendations put forth in the soon-to-be-completed Stanford Research Institute study of land mobile assignments.

While at the FAA, Spence was in charge of such long-term projects as aeronautical satellite systems and automated aircraft communications. He is also credited with getting NASA to include an L-band transponder on the upcoming Applications Technology Satellite.

Spence was able to make the switch from FAA to FCC because of a new Civil Service Commission ruling permitting executive reassignments among Federal agencies.



**Is there an AC digital  
voltmeter anywhere  
that can measure this  
waveform accurately?**

**.....And this one too?**

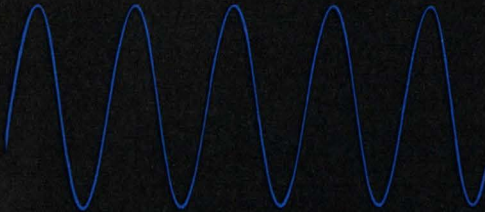

**There is now! The new Fluke 9500A  
true rms automatic digital voltmeter reads these  
complex waveforms to an accuracy of  $\pm 0.05\%$ .  
And if you know your AC's, that's progress.**

Another DVM on the market? Usually that's good for a ho-hum. But as we've said above, if you know your ac's, that's not the case with the new Fluke 9500A. It's the first automatic ac voltmeter capable of reading and digitally presenting the true rms value of any input—regardless of waveform—to 0.05% absolute accuracy (50 Hz to 10 KHz).

Frequency response is broad, 20 Hz to 700 KHz. The Model 9500A accepts voltage from .001 to 1100 volts rms in five ranges, each with 20% overranging. Range selection is automatic or manual. Crest factor of 10 virtually eliminates effects from voltage spikes or pulse trains.

Low capacitance, high resistance input minimizes loading effects.

Self-calibration is automatic whenever the instrument is turned on. On-line self-calibration is either automatic or manual, selectable by front panel switching. All controls and indicators, conveniently located on the front panel, are easy to use and understand. Complete control of the 9500A is possible from a remote facility if desired.

Price of the Model 9500A, including rack adapter, is \$2,485. Extra cost options include a probe input (\$75), rear panel BNC input (\$50), and 1-2-4-8 or 1-2-2-4 BCD digital outputs (\$195). For

complete information, please call your full service Fluke sales engineer (see EEM), or write directly to us here at the factory.

Fluke, Box 7428, Seattle, Washington 98133. Phone: (206) 774-2211. TWX: 910-449-2850. In Europe, address Fluke International Corp., P.O. Box 5053, Tilburg, Holland. Telex: 844-50237. In the U.K., address Fluke International Corp., P.O. Box 102, Watford Herts, England.



Circle 17 on reader service card



# Pick a number...

## Only Amphenol lets you pick from all four PC connector families

No matter which printed circuit connector family you choose, Amphenol produces it. In hundreds of thousands of combinations. No one else gives you this choice.

*Expect to save.* While gold, copper and labor costs go up, we keep modernizing production methods. Enough to maintain prices, even reduce them. We can show you how to save with all four families.

Check the PC connector families below. Then call your Amphenol Sales Office or Distributor. The connector you need is probably on the shelf. If it's a special we can help you design it. Write today for new PC Connector Catalog PC-5. Amphenol Industrial Division, The Bunker-Ramo Corp., 1830 S. 54th Avenue, Chicago, Ill. 60650.



**1 BIFURCATED BELLOWS CONTACTS** For smooth, positive mating action—that's easy on your PC board surface—pick Amphenol's 225 Series. Bifurcation provides 2 points of contact, even on irregular surfaces. Bellows action exerts positive pressure, even under extreme vibration. Gives you thousands of insertions and withdrawals without failure. Nine sizes, ten tail styles, four mounting configurations, two contact platings, and solder, taper pin or Crimp Poke-Home® terminations. Exceeds MIL-C-21097B.

**2 TUNING FORK CONTACTS** For the lowest contact resistance in the industry today—even with PC boards at the extremes of tolerance in thickness—pick Amphenol's 143 Series. Amphenol's tuning fork contacts provide excellent current-carrying capability with uniform tine pressure and positive wiping action. For non-direct card entry applications, the 143 Series receptacle can be mated with a 133 Series plug. Nine tail styles, eight sizes and choice of solder or solderless wrap terminations. Series 233/243 exceeds MIL-C-21097B.

**3 PRELOADED CANTILEVER CONTACTS** For a low cost, high performance connector—designed especially for automatic wire wrapping—pick Amphenol's 261 Series. Cantilever contacts are confined in the dielectric to a predetermined load force. This gives you uniform pressure and positive mating action. Contacting surfaces have a minimum of 50 microinches of gold over phosphor bronze. Wire wrap capability on .100", .125", .150", .156" and .200" centers. Also, high contact density multi-board connectors for your special applications.





**4** **MODULAR PLATE ASSEMBLIES** For custom designed specials at production line prices—with up to 36,000 contacts—pick Amphenol's 230 Series Snap-Wrap® or 240 Series Mini-Wrap® connectors. Design your own interconnection system using Amphenol's building block concept. The contacts you need are inserted into nylon insulators and mounted into aluminum plates. These plates can be drilled, formed or notched to your specifications. Snap-Wrap 230 Series: 7 contact styles, 12 color-coded insulators with plate sizes up to 22" x 45". Mini-Wrap 240 Series: 4 contact styles, 12 color-coded insulators, .100", .125" or .150" centers with plate sizes up to 21" x 24". The same modular concept is now available for direct card entry applications with our 250 Series.

®Registered trademarks of The Bunker-Ramo Corporation



**AMPHENOL**

THE BUNKER-RAMO CORPORATION

Circle 19 on reader service card





The accuracy is a "first" in DVM design. 0.0025%. Stability is too. .0065% for a full year over a temperature range of +12° to +40°C. Nor do the "firsts" stop here.

There's a speed you've never seen. 18 milliseconds for dc, and 45 milliseconds for ac.

There's no other unit more of a stranger to noise. It has the now famous "3-pole, active filter." This outshines an integrator or a notch filter anytime. You can even choose the amount of noise rejection by either programming or manually selecting the filter position.

And since the unit is a box-within-a-box, it's immune from common mode noise.

There's a flexibility you've never heard of before. Four dc, four ac, and four dc/dc ratio ranges, three dc millivolt ranges, and five kilohm ranges.





# You pay for the accuracy. The pretty face is free.

There's no instrument more compatible.

Both the digital output and programming are completely isolated. No grounding problems.

There's nothing easier to calibrate. No adjustments, just a single point calibration. Once a year.

There's nothing easier to maintain. All the plug-in boards can be slipped in and out from the front.

Which brings us to the pretty face. We put it on because, when you make the best DVM in the world you might as well make it look the part.

*Speaking of handsome, we have a brand new brochure with all the specs on the 5700 and every other Dana instrument. Own one. Write Dana Laboratories, Inc., 2401 Campus Drive, Irvine, Calif. 92664.*

**DANA**

Circle 21 on reader service card



# A Smart Way to Beat Your Power Supply Size Problem

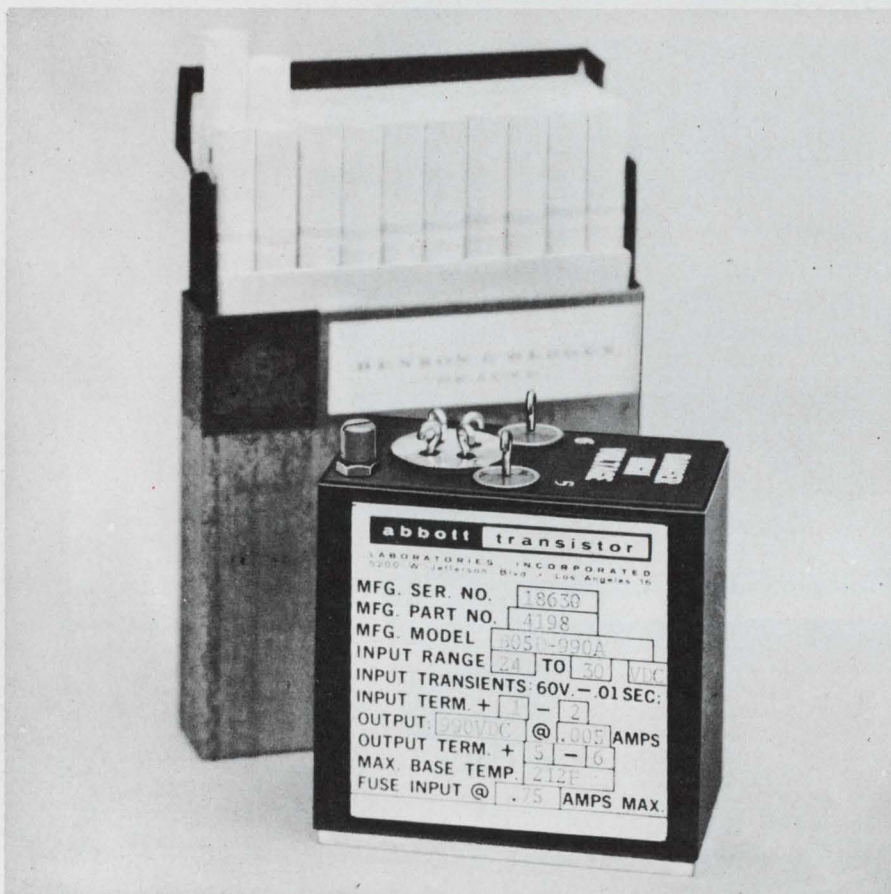

## abbott

1½" thin, 2¾" short, yet this converter produces 1000 volts DC, regulated, from a battery input of 28 VDC! It weighs less than 15 ounces. This is only one of our wide variety of many small light weight converters, inverters and power supplies—there are over 3000 models listed in our newest catalog, including size, weight, and prices. If you have a size problem, why not send for an Abbott catalog?

**MIL SPEC ENVIRONMENT** — All of the power modules listed in our new catalog have been designed to meet the severe environmental conditions required by modern aerospace systems, including MIL-E-5272C and MIL-E-5400. They are hermetically sealed and encapsulated in heavy steel containers. New all silicon units will operate at 100°C.

Please write for your FREE copy of this new catalog or see EEM (1968-69 ELECTRONIC ENGINEERS MASTER Directory), Pages 1727 to 1740.

**abbott transistor**

LABORATORIES, INCORPORATED

5200 W. Jefferson Blvd./ Los Angeles 90016  
(213) WEBster 6-8185 Cable ABTLABS

**RELIABLE** — Highest quality components are used in Abbott power modules to yield the high MTBF (mean time between failure) as calculated in the MIL-HDBK-217 handbook. Typical power modules have over 100,000 hours MTBF — proving that the quality was built in from the beginning.

**WIDE RANGE OF OUTPUTS** — Any voltage from 5 volts DC to 10,000 VDC is available by selecting the correct model you need from our catalog with any of a variety of inputs including:

- 60 $\phi$  to DC, Regulated
- 400 $\phi$  to DC, Regulated
- 28 VDC to DC, Regulated
- 28 VDC to 400 $\phi$ , 1 $\phi$  or 3 $\phi$
- 60 $\phi$  to 400 $\phi$ , 1 $\phi$  or 3 $\phi$

TO: Abbott Transistor Labs., Inc., Dept. 57  
5200 West Jefferson Blvd.  
Los Angeles, California 90016

Sir:  
Please send me your latest catalog on power supply modules:

NAME \_\_\_\_\_ DEPT. \_\_\_\_\_

COMPANY \_\_\_\_\_

ADDRESS \_\_\_\_\_

CITY & STATE \_\_\_\_\_

## Meetings

### Wincon: avionics and traffic

**Military avionics** and control of civilian traffic—both in the air and on the ground—will be emphasized at the Winter Convention on Aerospace and Electronics Systems (Wincon), Feb. 11 to 13 at the Biltmore Hotel in Los Angeles.

David Thomas, head of the Federal Aviation Administration, will be both session chairman and keynoter at the air traffic control session. Scott Crossfield, an Eastern Airlines vice president, will give the airline view of solutions to air traffic control problems. Then two representatives of the FAA's system research and development service will talk about collision prevention and communications.

The Federal Highway Administration's electronic systems requirements will be spelled out by G.W. Clevon, the agency's science adviser, in the vehicle traffic control session. W.E. Schaefer of the California Division of Highways is to present a paper on freeway surveillance and control, and J.G. Reid of TRW Systems will outline approaches to automating urban traffic control.

**Separate needs.** Of the seven classified sessions, three will be devoted to military avionics. The services are becoming increasingly disenchanted with the Defense Department's push for commonality in major systems, and the avionics sessions at Wincon reflect this; each service will outline its separate needs to industry for the multitude of new aircraft now in the proposal stage.

For more information, write Dale Bagley, TRW Systems Group, 1 Space Park, Redondo Beach, Calif. 90278.

## Calendar

**American Association for the Advancement of Sciences; Dallas, Dec. 26-31.**

**Winter Television Conference, Society of Motion Picture and Television Engineers; Ryerson Polytechnical**

(Continued on p. 24)





## A Communications System Test Set (VLF to HF)...

From Sierra comes the most thoroughly human-engineered instrument for HF-radio and telephone-carrier applications in today's knob- and meter-ridden world: The Model 305/360 Communications System Test Set.

Model 305/360 gives you ultra-bright, unambiguous electronic digital readouts of frequency. Built-in counter automatically totals outputs of both the coarse and fine tuning oscillators, reads out tuned frequency with 10-Hz resolution. Attenuator levels appear in three-digit displays, with unique logic and switching circuits combining the levels of the 10-dB and 1-dB per step attenuators. Rear-projection meters with luminous pointers permit parallax-free viewing from any angle with easy resolution of fine-level increments.

Performance features include phase-locked tuning circuits, a single continuous tuning range covering voice frequencies through 32 MHz, and selective bandwidths of 250 and 3100 Hz. You can resolve signals separated by as little as 35-Hz.

Model 305/360 does everything humanly possible to keep foibles from fouling your readings. For the brochure, write Sierra, 3885 Bohannon Drive, Menlo Park, California 94025.

\*Average to Very Bright

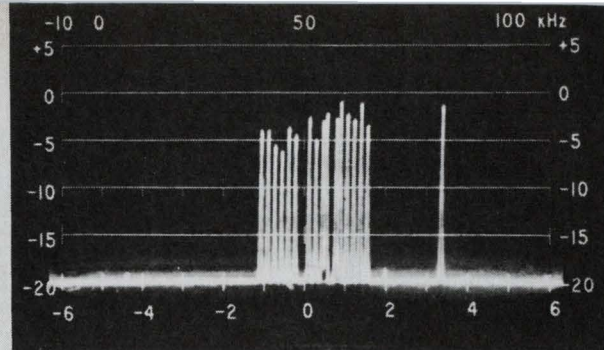

Three 4-kHz channels of L3 carrier multiplex system. Center channel has teletype subcarriers. Model 360A is in 12-kHz sweep width mode, sweeping from 6.780 to 6.792 MHz.



Switch-selected meter modes, normal or expanded scale, provide level measurement resolution of 0.05 dB. Signal generator level increments as fine as 0.01 dB can be readily resolved.

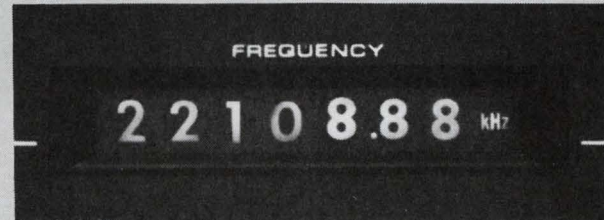

Frequency resolution to nearest 10 Hz in phase-locked tuning mode is displayed on flat-plane, high-brightness readouts. Alternative continuous tuning mode presents frequency resolved to nearest 100 kHz.

## engineered for humans (A to VB\*)



PHILCO-FORD CORPORATION  
Sierra Electronic Operation  
Menlo Park, California • 94025

Circle 23 on reader service card



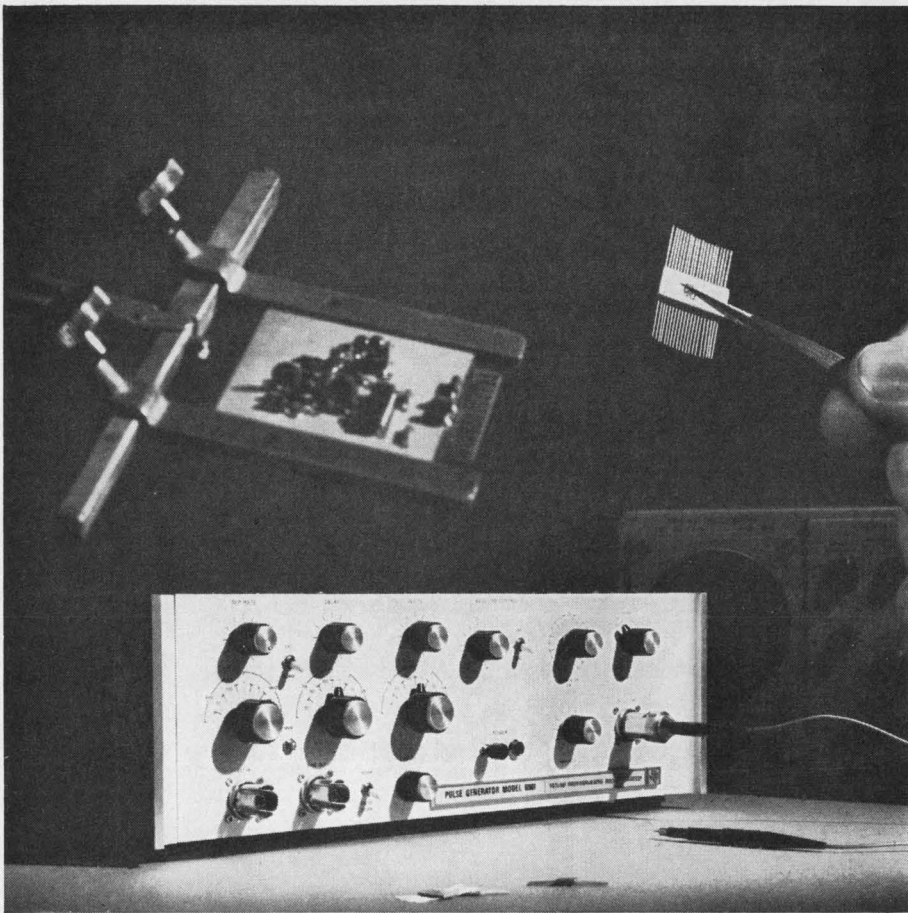

## Why You Need a Special Pulse Generator for State of the Art Circuit Design

With high speeds and critical design parameters, you need the best test instruments to be sure your designs will be optimum. The TI Model 6901 Pulse Generator gives outputs from 1 KHz to 0.1 GHz; independent amplitude and baseline controls; jitter less than 0.1% of period + 50 psec; and count-down synchronization output.

The 6901 makes your designing simpler, too. Because the pulse amplitude of the generator can be changed without affecting DC offset, you can use the offset instead of an external bias supply for your circuit.

For additional information, contact your TI Field Office, or the Industrial Products Division, Texas Instruments Incorporated, P. O. Box 66027, Houston, Texas 77006.

**TEXAS INSTRUMENTS**  
INCORPORATED

627A

## Meetings

(Continued from p. 22)

Institute, Toronto, Jan. 17-18.

**Symposium on Reliability, IEEE;**  
Palmer House, Chicago, Jan. 21-23.

**Second Hawaii International Conference,**  
Department of Electrical Engineering,  
University of Hawaii, Honolulu, Jan.  
22-24.

**Winter Power Meeting, IEEE;** New York,  
Jan. 26-31.

**International Symposium on  
Information Theory, IEEE;**  
Nevele Country Club, Ellenville, N.Y.,  
Jan. 28-31.

**PMA Meteorology Conference,** Precision  
Measurements Association; The  
Ambassador, Los Angeles, Feb. 3-5.

**Transducer Conference (G-IECI),**  
National Bureau of Standards; Twin  
Bridges Marriott Hotel, Washington,  
D.C., Feb. 10-11.

**Winter Convention on Aerospace and  
Electronics Systems (Wincon), IEEE;**  
Biltmore Hotel, Los Angeles,  
Feb. 11-13.

**First National Conference on Electronics  
in Medicine, Electronics, Medical World  
News, and Modern Hospital Magazines;**  
Statler-Hilton Hotel, New York,  
Feb. 14-15.

### Short courses

**Computer Programing for Electrical  
Engineers,** following Reliability  
Symposium, IEEE; Sherman House,  
Chicago, Jan. 23-24; \$90 fee for  
nonmembers, \$75 fee for members.

**Fortran—Introduction to Computing for  
Engineers,** University of Wisconsin,  
Madison, Jan. 27-31; \$200 fee.

### Call for papers

**National Aerospace Electronics  
Conference (Naecon), IEEE;** Sheraton-  
Dayton Hotel, Dayton, Ohio, May 19-21.  
**March 1** is deadline for submission of  
abstracts to James E. Singer, chairman,  
technical program 1969 Naecon, 5705  
Coach & Four Dr., E. Kettering, Ohio  
45440.

**Chicago Spring Conference on  
Broadcast and Television Receivers,**  
IEEE; Marriott Motor Hotel, Chicago,  
June 9-10. **Feb. 10** is deadline for  
submission of papers to J.A. MacIntosh,  
papers committee, Fairchild  
Semiconductor, 7310 W. North Ave.,  
Elmwood Park, Ill. 60635.



# CONDUCTIVE PLASTIC POTS

## "From Duncan With Love"

(OR WHY EVERYONE SHOULD SPECIFY THE DUNCAN CP POT WITH THE ELEMENT FORMULATED WITH LOVING CARE)

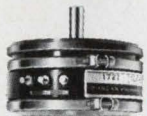

### RESOLON® SPECIFICATIONS

State-of-the-art design and strict quality control provides Duncan Resolon potentiometers with these outstanding features:

- **Long Life:** 20 million shaft revolutions without significant change in characteristics
- **Low temperature coefficient:** -300ppm/°C max.
- **Wide temperature range:** -65°C to +125°C
- **Conformance** to all applicable MIL specs, including MIL-R-39023
- **Low output smoothness:** maximum of 0.1% of total applied voltage
- **Linearity and conformity tolerance** to  $\pm .05\%$
- **Single-turn/servo-mounted;** available in  $\frac{7}{8}$ " to 3" diameters
- **Linear or non-linear functions** may be provided

CALL OR WRITE TODAY FOR COMPLETE RESOLON BROCHURE

de

DUNCAN electronics, inc.

a division of Systron-Donner Corp.  
2865 FAIRVIEW ROAD, COSTA MESA, CALIFORNIA 92626  
TEL: (714) 545-8281 • TWX (910) 595-1128

Circle 25 on reader service card



# Best connectors on

**Blade-type connector.** A rugged two-piece printed circuit connector that meets MIL-C-21097B. Tab housing of diallyl phthalate or phenolic is clinched and soldered to the daughter board. Receptacle contacts are crimp, snap-in type. Contact options include wrap posts or solder tabs.

**Leaf-type connector.** A one-piece connector for single or double-sided printed circuit boards. Snap-in leaf contacts lock in place on .156" centers, maintain constant pressure on circuit paths. Contact tail end options include crimp-to-wire, wrap post or solder tab. Housings of diallyl phthalate or phenolic are eggcrated. Contacts not pre-loaded; use only number of contacts required.

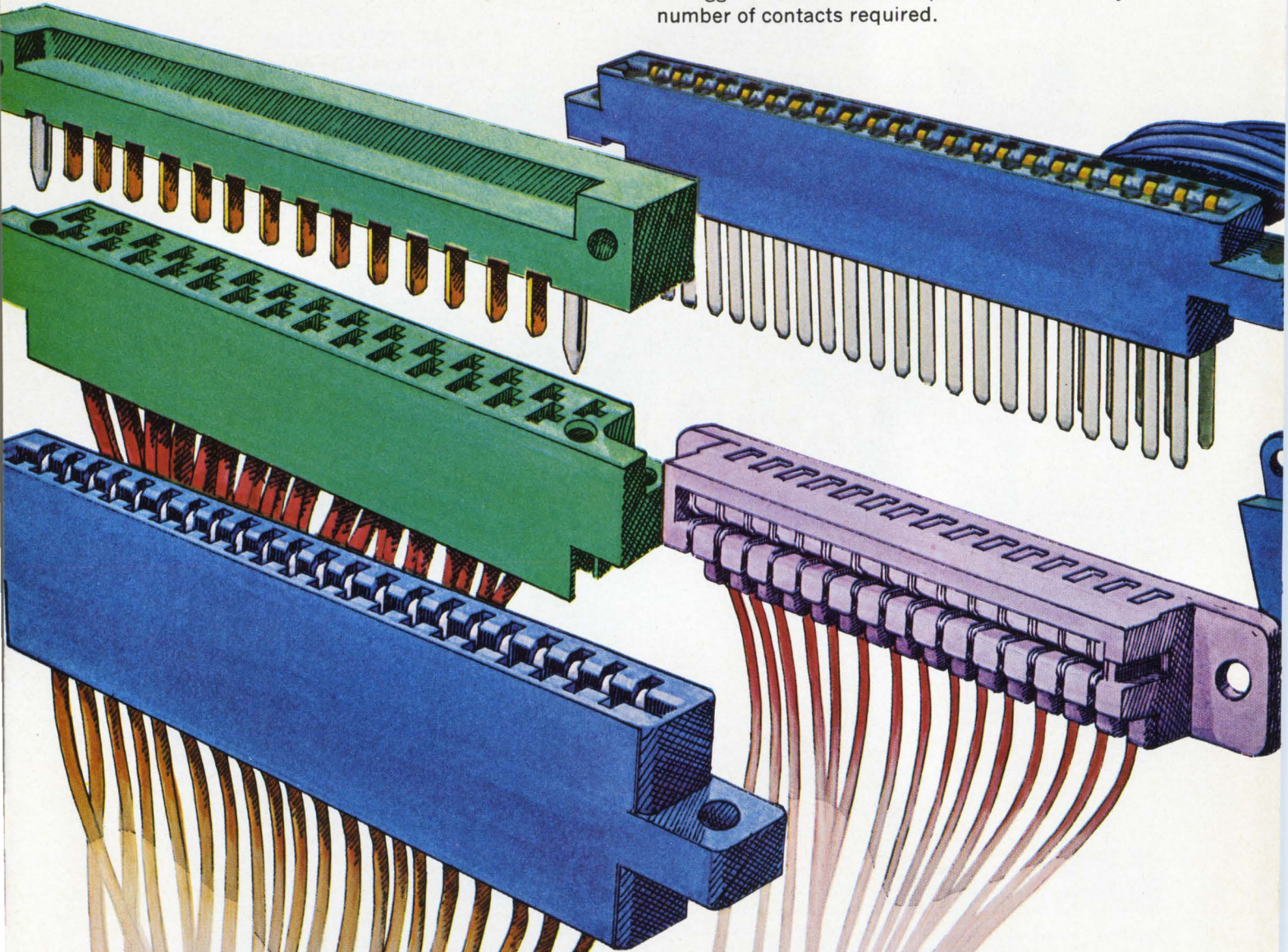

**Fork-contact connector.** A one-piece polysulfone connector with eggcrated contact cavities; up to 33 positions. Capability for .100" center spacing. Improved fork contact design with large curved contact surfaces for smooth insertion and excellent conductivity. Crimp, snap-in contacts.

**Right-angle connector.** Compact one-piece connector saves space in sub-assemblies on vending machines, appliances, etc. Right-angle board entry facilitates compact cabling. Housing may be keyed; slips on board edge. Recessed snap-in fork type contacts; available in 3 to 22 positions.



# the printed circuit.

**TERMI-TWIST\* Connector.** This connector combines economy and reliability with highly efficient application tooling techniques. Closed entry diallyl phthalate or phenolic housings accept boards from .054" to .071" thick. Snap-in, bifurcated contacts adaptable for a wide variety of wire attachment methods. Can be used with solder, weld, wrap or TERMI-POINT\* clip techniques.

*Part of a complete line of AMP-UNYT\* printed circuit connectors available from AMP . . . Worldwide.*

\*Trademark of AMP Incorporated

# AMP

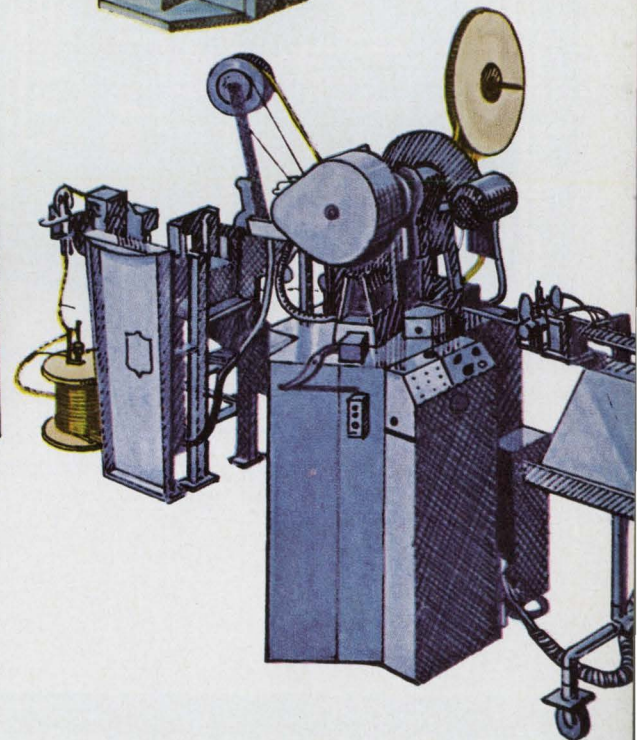
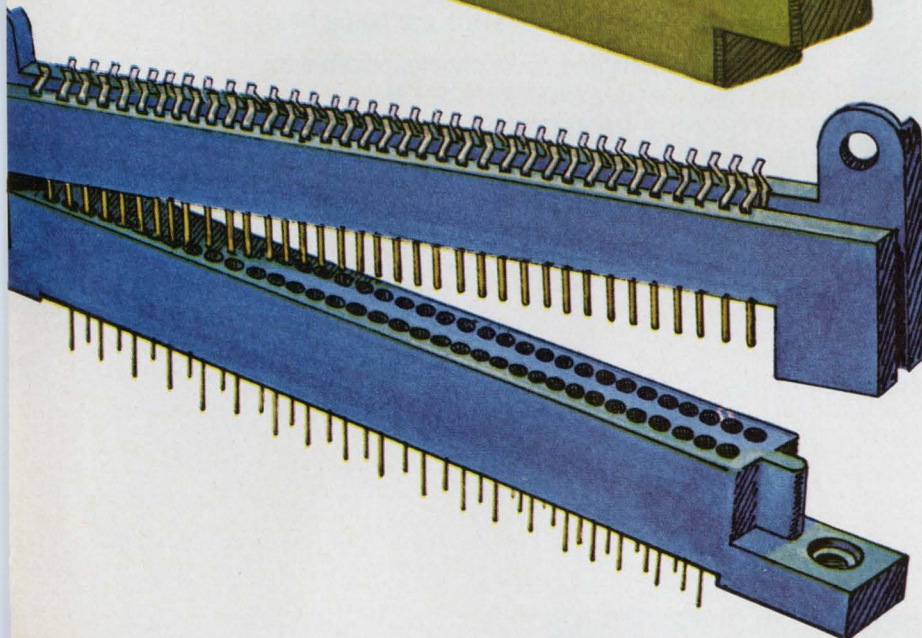
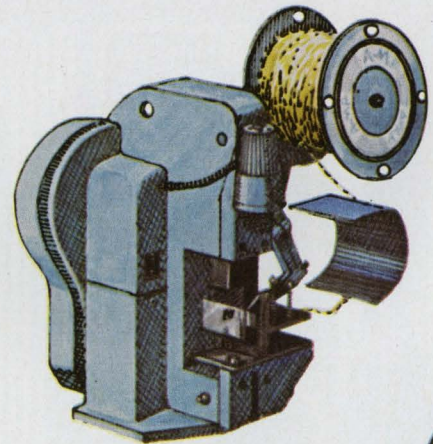
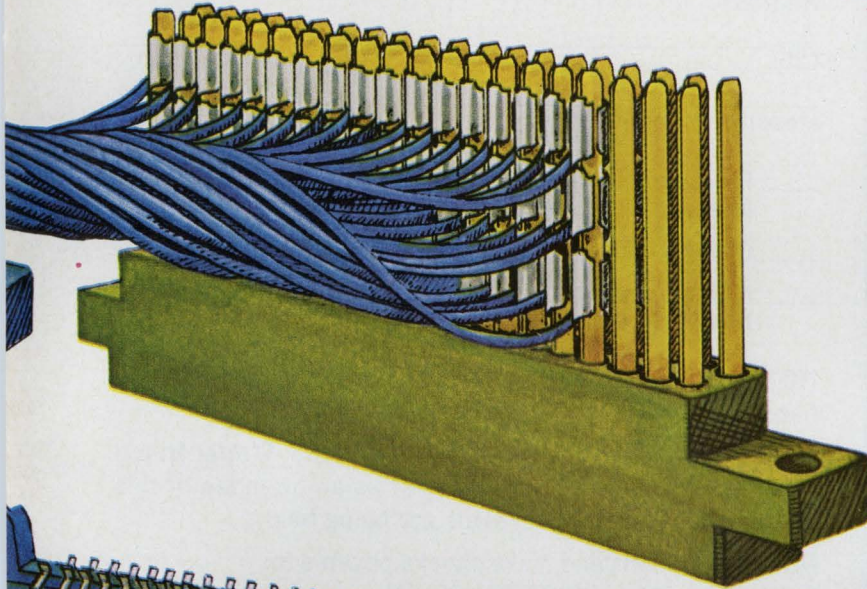

**Box-contact connector.** A superior two-piece board-to-board or board-to-wire connector provides high density with low insertion and extraction forces. Unique contact design allows wide mismatching tolerances. Ten to 180 contacts on .075" centers. For black-box, computer and other high reliability applications. Exceptional low cost for exclusive features incorporated.

A full range of semi-automatic and fully automatic machinery is available for high-volume production and lower installed cost. AMP's large assortment of printed circuit connectors permits proper selection of the best connector for any requirement. Matched tooling plus advanced engineering give you unsurpassed performance, economy and reliability.

For detailed catalog information on these products, contact **AMP Incorporated, Harrisburg, Pa. 17105**

Circle 27 on reader service card



# Doctors:

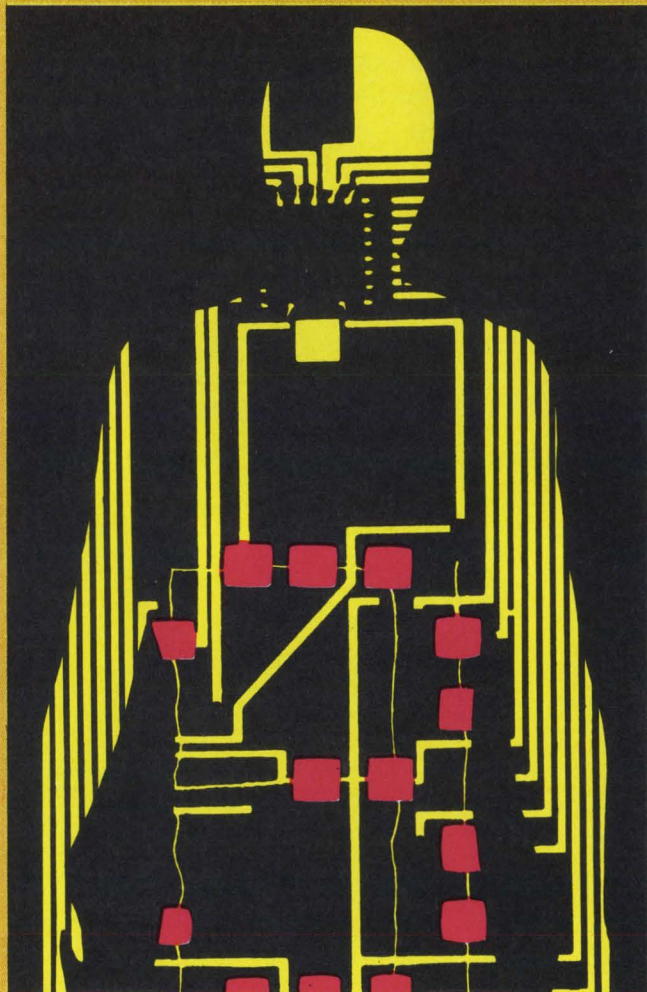

## ADVANCE REGISTRATION

### FIRST NATIONAL CONFERENCE ON ELECTRONICS IN MEDICINE

February 14-15

Statler-Hilton, New York, N.Y.

Registration Fee: \$125

Name \_\_\_\_\_

Address \_\_\_\_\_

City \_\_\_\_\_

State \_\_\_\_\_

Zip \_\_\_\_\_

Hospital or Company \_\_\_\_\_

Position \_\_\_\_\_

Please register the above for the ELECTRONICS IN MEDICINE Conference

Check enclosed  Send invoice

Mail an additional registration form with descriptive brochure.

**NOTE:** Attendance will be limited and applications will be handled on a first-come, first-served basis.

Make hotel reservations directly with the Statler-Hilton before February 1. Identify yourself as an attendee of this conference. A number of rooms are being held.

Mail registrations and make checks payable to:  
FIRST NATIONAL CONFERENCE ON  
ELECTRONICS IN MEDICINE  
330 West 42nd Street, New York, N.Y.

Here's your chance to learn how electronics can help you care for your patients and manage your practice. Tell the nation's leading electronics firms what you really need for diagnosis, therapy, and monitoring. See the latest equipment demonstrated and critiqued.

## FIRST NATIONAL CONFERENCE ON ELECTRONICS IN MEDICINE

February 14-15

STATLER-HILTON, NEW YORK, N.Y.

*Presented by McGraw-Hill Publications:*

ELECTRONICS / MEDICAL WORLD NEWS / MODERN HOSPITAL

## CONFERENCE OUTLINE

### Computers In Medicine

- Computers join the medical team
- What are computers doing in medicine?
- Diagnosis by computer
- Data processing in the doctor's office
- How to communicate with the computer
- Small computers—new para-medical aids



# Engineers:

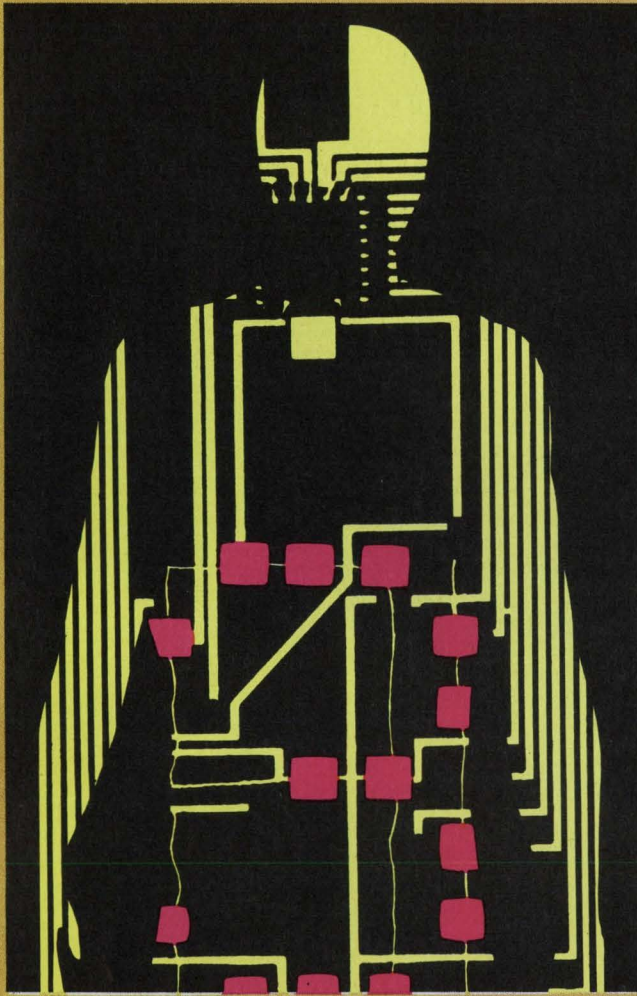

## ADVANCE REGISTRATION

**FIRST NATIONAL CONFERENCE ON ELECTRONICS IN MEDICINE**  
February 14-15 Statler-Hilton, New York, N.Y.

Registration Fee: \$125

Name \_\_\_\_\_

Address \_\_\_\_\_

City \_\_\_\_\_

State \_\_\_\_\_

Zip \_\_\_\_\_

Company \_\_\_\_\_

Position \_\_\_\_\_

Please register the above for the ELECTRONICS IN MEDICINE Conference

Check enclosed  Send invoice

Mail an additional registration form with descriptive brochure.

**NOTE:** Attendance will be limited and applications will be handled on a first-come, first-served basis.

Make hotel reservations directly with the Statler-Hilton before February 1. Identify yourself as an attendee of this conference. A number of rooms are being held.

Mail registrations and make checks payable to:  
FIRST NATIONAL CONFERENCE ON  
ELECTRONICS IN MEDICINE  
330 West 42nd Street, New York, N.Y.

Make the most of this opportunity to help close the communications gap between medicine and electronics. Join the world's leading physicians and medical specialists in bilateral discussions. Help match their real needs to the dynamic capabilities of electronics.

### Instrumentation In Medicine

- Is it being designed and used properly?
- Achievements and barriers
- Instrumentation in practical patient management
- Protecting the patient—standards and safety
- Government regulation

### Medical-Engineering Relationships

- Why can't doctors and engineers communicate?
- What the hospital administrator wants

### Systems Engineering

- Marshalling medical resources through systems
- Prescription for large-scale health care
- Remodelling the surgery department

### Demonstrations

- Patient monitoring, and computer-aided diagnosis systems, xerographic mammography techniques, a pulmonary function analyzer, and an electric power monitor will be demonstrated and critiqued by a panel of physicians and engineers.



Foxboro engineers select A-B hot molded potentiometers  
"Best repeatability—component-to-component  
and setting-to-setting"

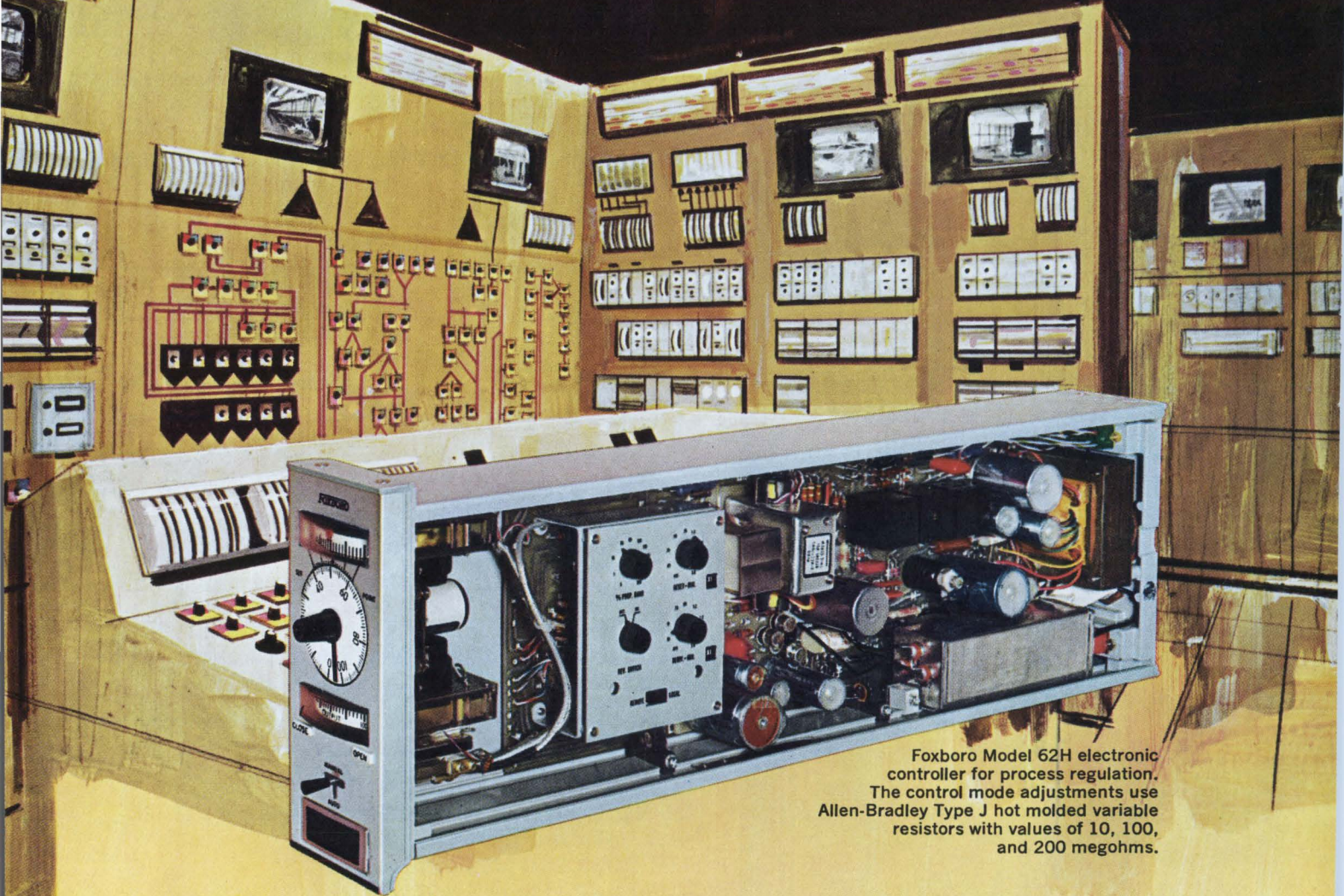

Foxboro Model 62H electronic controller for process regulation. The control mode adjustments use Allen-Bradley Type J hot molded variable resistors with values of 10, 100, and 200 megohms.

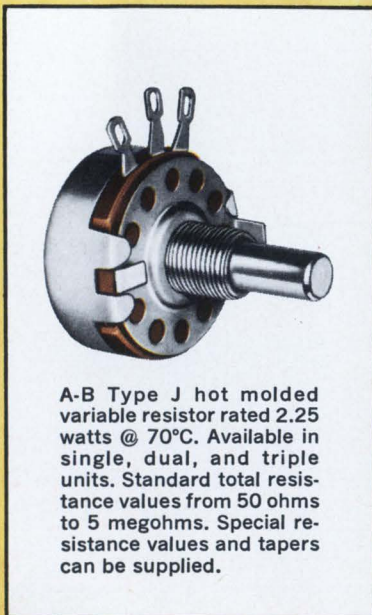

A-B Type J hot molded variable resistor rated 2.25 watts @ 70°C. Available in single, dual, and triple units. Standard total resistance values from 50 ohms to 5 megohms. Special resistance values and tapers can be supplied.

Widely used throughout the process industries, the Foxboro Model 62H Universal Controller is a highly dependable precision instrument. During the years of painstaking development, Allen-Bradley engineers worked closely with Foxboro to provide a potentiometer having unusually high resistance values, which would provide the precise performance required.

Allen-Bradley Type J potentiometers were the answer. They have a solid hot molded resistance track which is produced by an exclusive A-B molding technique that assures extremely long operating life. Accelerated tests—exceeding 100,000 revolutions—show very slight resistance change. Control is smooth at all times with adjustment approaching infinite resolution. There are none of the abrupt turn-to-turn resistance vari-

ations inherent in wirewound controls. Furthermore, Allen-Bradley Type J potentiometers are—for all practical purposes—noninductive, permitting their use throughout the frequency spectrum.

Whether your particular circuit design can be best satisfied with one of the millions of standard Type J variations or whether it calls for unusual resistance characteristics, it will pay you to look first to A-B Type J potentiometers. Their more than 25-year history of providing superior performance is your guarantee of complete satisfaction. For full details, please write for Technical Bulletin 5200: Allen-Bradley Co., 1201 South Second Street, Milwaukee, Wisconsin 53204. Export Office: 630 Third Avenue, New York, N. Y., U.S.A. 10017. In Canada: Allen-Bradley Canada Limited.



**ALLEN - BRADLEY**  
QUALITY ELECTRONIC COMPONENTS



---

**Editorial comment**

---

## Automation: good barometer for markets

A straightforward extrapolation of earlier predictions led Bell Labs' Jim Early to assert this month at the Reliability Physics Symposium that integrated circuits and arrays will soon be so cheap and reliable they'll open up vast new areas in which to apply electronics.

There's little doubt that many technological events predicted by Early and others will take place on schedule. But we are doubtful about the easy application of the new technology to hitherto unexploited fields. Just where are the new markets?

Part of the answer lies in a study just released by McGraw-Hill Publications' department of economics. The study tells what percentage of capital investment each major segment of U.S. industry

has earmarked for automation—a good indicator of new markets for computers, controls, and other industrial electronics gear.

The iron and steel industry intends to devote a dramatic 45% of its capital investment to automation next year, and more in 1970. The machinery (including electrical) and chemical industries will spend about 33% for automation, while the auto, nonferrous metals, paper and pulp, rubber, fabricated metals and instruments, and food and beverage industries will spend at least 20%. The utilities will hold to their consistent 14%, representing about \$1.5 billion per year.

Automation's challenge to the electronics industry is clear. ■ ■

## "Competition is good . . . sometimes"

"Large and lucrative" is how the President's Task Force on Communications Policy describes the market for computer communications (teleprocessing). In a report just made public, the task force recommends the market be open and nonregulated for all but the telephone companies (see Electronics Review story). Competition, it thinks, is better than regulation, and could even "stimulate entrenched firms to greater efficiency and progress." Under the proposal, new private companies could hook into the lines of the Bell System, for example, and while Bell could compete, it would not be permitted to operate at a loss to undercut the new competition. Those who envision the prompt formation of a new monopoly—a computer or information utility—are doubtless doing so prematurely. The task force notes these safeguards against such an eventuality:

- Computer hardware costs are declining faster than even the costs of long-haul transmission.

- In the long run, the tradeoff between the cost of duplicating data storage facilities and the cost of gaining access to a central computer favors the former.

- The industry is far from overcoming the very high costs of managing a time-sharing system, especially one that accommodates users with diverse requirements. Such costs limit the size of these systems.

While opting for competition on the domestic teleprocessing front, the task force favors a Government-sponsored monopoly to compete on the international communications scene. It suggests a "new

single entity" that would take over international transmission facilities of all existing U.S. carriers [Electronics, Nov. 25, p. 58]. The present setup, described as a "fragmented ownership structure" by the committee, is said to foster inefficiencies of competition between satellites and cables. The new structure would be expected to provide a united front for U.S. interests abroad and simplify regulation. The committee calls for a merger of facilities such as AT&T's overseas cables, Comsat's satellites and ground stations, and Western Union's terminals and switching stations into one privately owned company. Further, the committee says there is no real basis for competition since all companies are now using identical transoceanic facilities; a merger would make duplicate ground and switching stations unnecessary, permitting efficient operation and reduced rates.

However, the report fails to spell out the role of the existing carriers and the FCC, how the new monopoly would be formed, and its relationship to Comsat. Even members of the committee find it hard to accept the proposal without qualification. One member, Edward Welsh, executive secretary of the National Aeronautics and Space Council, feels the monopoly would inhibit progress in satellite technology and stifle the competition between satellites and cables that could lead to rate cuts.

For the most part, the task force's recommendations concerning the open market for domestic data communications make sense. But we'll reserve judgment about the international monopoly. ■ ■



# How many Mil-Spec counter-timers now provide performance to 3.3 GHz?

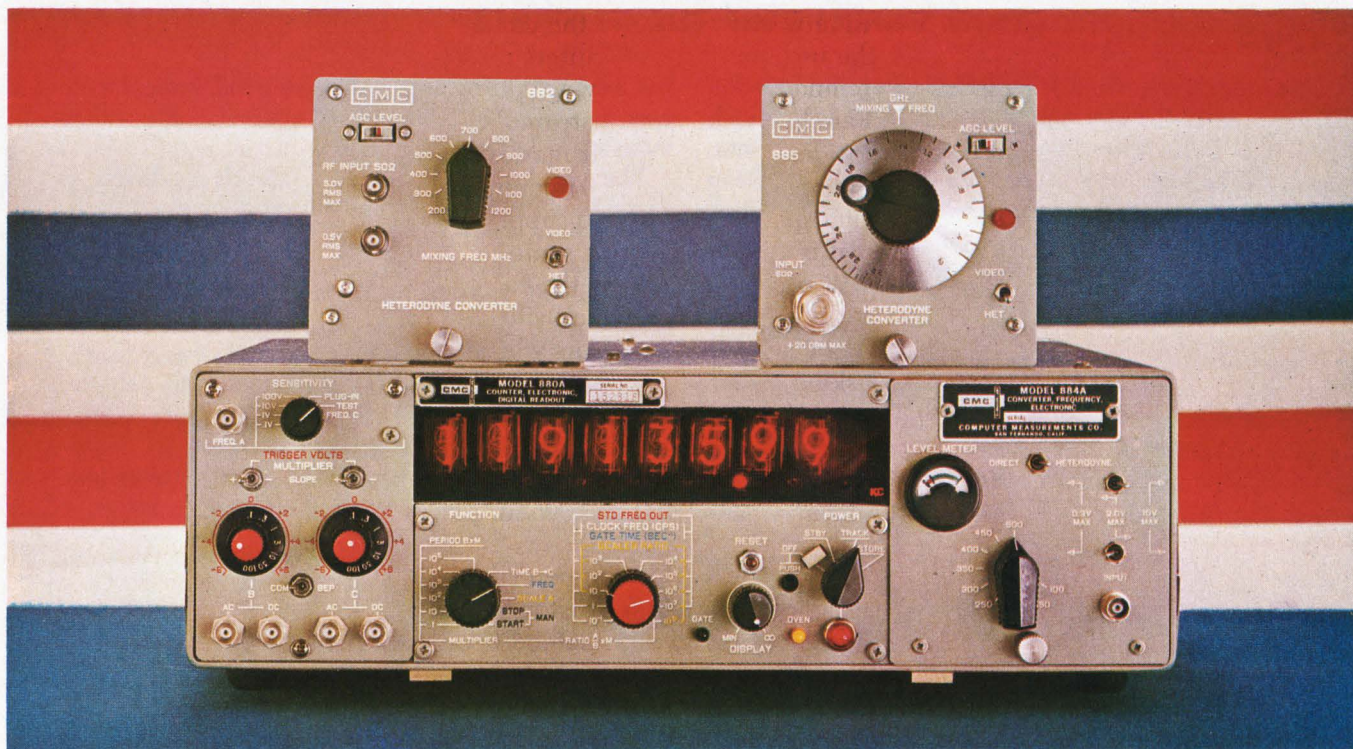

# ONE!

## And it's the CMC 880 with two new plug-ins!

The CMC Model 880 is the only high-frequency counter-timer commercially available that has been designed, tested, and field-proven to meet all pertinent military specifications.\*

This rugged, completely portable instrument, with its drip-proof clip-on cover and valise handle, has already proven itself in the toughest military and industrial applications. And the CMC 884, a companion heterodyne converter, has been right there when needed to boost the 880's 100-MHz direct-counting range up to 555 MHz. So what else is new? Plenty!

Here are two new plug-ins that further set the 880 apart as the only Mil-Spec counter-timer offering performance in the gigahertz range. The Models 882 and 885 Heterodyne Converters will now boost the 880's frequency range to 1.3 GHz and 3.3 GHz respectively, and both feature built-in video amplifiers providing a sensitivity to 10 mV, the use of

all solid-state components, and an accuracy equal to that of the basic counter.

So when you've got a job to do where the going's rough—try the 880. You'll be in good company if you do. And for your copy of CMC's new 12-page Military Counter brochure with complete specifications, circle the reader service card.

*\*The Model 880 meets all requirements of MIL-E-16400, Shock Spec MIL-S-901, and RFI Spec MIL-I-16910.*



A Division of Pacific Industries

12970 Bradley/San Fernando, Calif. 91342/(213) 367-2161/TWX 910-496-1487



---

# Electronics Newsletter

---

December 23, 1968

## Fairchild may buy Westinghouse IC division

No sooner had Westinghouse Electric announced that its Molecular Electronics division was going out of the commercial integrated circuit business than the usual influx of recruiters descended on Elkridge, Md.; but they were temporarily stymied by a report that the entire division might be sold to Fairchild Camera & Instrument. Neither company would comment, but insiders say that a deal may be made before year's end.

Westinghouse has about 1,200 employees in 170,000 square feet of manufacturing space and is said to supply 80% of the semiconductor fuse market. But it is reportedly losing some \$3 million a year on sales of \$15 million to \$18 million. Although the facilities are considered excellent, the company is still using 1½-inch silicon wafers so that its costs will run higher than those of competitors who have switched to 2-inch wafers, and the masking shop reportedly needs modernizing.

Except for the early integrated circuit days, when it tried to establish the W200 line of DTL but lost out to Fairchild's 930 line, Westinghouse has never been known as an innovator. Its product line is broad, but except for linear circuits for fuses, volumes are low—meaning that costs are high.

The decision to dump the commercial IC line follows by only a few weeks Westinghouse's decision to stop making television sets.

Westinghouse does apparently intend to keep some sort of IC facilities for in-house use, although it already has IC-production capability at its Defense and Space Center.

## Computers to keep stock sales records

A computerized system for handling over-the-counter securities sales will be developed and operated by Bunker-Ramo. Under a contract that could total \$50 million over seven years, Bunker-Ramo will provide the data for desk-top terminals in stock brokers' offices. The system being sought by the securities dealers' trade association will use Univac 1108 computers to keep track of dealings in up to 20,000 securities. Such transactions are currently recorded by hand and transmitted by telephone; tabulations are printed on mimeographed sheets daily.

## MOS drives TTL directly

In time for the IEEE Convention next March, the components group of Texas Instruments will announce an MOS shift register that uses a lateral pnp transistor as the output device, so as to drive TTL circuits directly at a rate of 10 megahertz.

Metal oxide semiconductor circuits are always slowed by the relatively large output devices required to handle outside capacitances. The small interior MOS transistors can click along at 10 Mhz, but they are slowed when one of them has to drive a device 10 times its size. (Normally, the devices begin to get larger and larger through the last 5 bits of delay.)

"We expect to interface directly to TTL at full speed," says Robert Proebsting, TI's manager of MOS memory devices. The company's series 74 must sink 1.6 milliamperes of current at a voltage drop of not more than 0.4 volts for a logical zero.

The bipolar transistor requires an extra n<sup>+</sup> diffusion step that is not necessarily optimum for the processing of the rest of the device, according to some makers who have considered using the TI method. But TI is



# Electronics Newsletter

already making similar devices on an audio amplifier, and does not expect any difficulty in putting one on a shift register. The first circuit to have the bipolar output will be a dual 100-bit register.

## Raytheon, Sylvania improve Suhl line

When does a new, improved circuit rate being called a new-generation device?

Raytheon Semiconductor will announce next month a superfast version of Sylvania's Suhl; it'll be called the Ray 3 and is billed as twice as fast as Suhl 2 with no increase in power required.

Sylvania, on the other hand, says Raytheon is playing the numbers game with the high-level TTL. It claims that its Suhl 2 line has been improved to within 10% or 15% of the Ray 3 speed. But Sylvania doesn't plan to call its improved version the Suhl 3 because the company feels renaming the family would lead to customer confusion and stocking problems at the distributor level. Further, Sylvania plans to continue to upgrade the Suhl 2 line.

Ray 3's gains are based on some improved technology: extremely shallow emitter diffusions and 0.1-mil lines.

The new circuits, which will be fully compatible with Suhl although made with entirely different masks, will have typical propagation delays of 4.5 nanoseconds (5.5 nsec maximum) and power dissipation of 10 milliwatts per gate.

So-called "washed emitters" only 0.3 micron deep are the key to the fast circuits, according to Raytheon's marketing manager Marshall Cox. "You have to have excellent process control, or you don't get any emitters at all," Cox says. First circuits in the series will be AND input and OR input J-K flip-flops, and a quad 2-input gate. The series will be priced about 25% higher than Suhl 2, but Cox says that in medium to high volumes it will compete with Suhl 2.

## Delays in output of Standard missile said to be overcome

General Dynamics/Pomona says it's solved its technical problems with the Standard surface-to-air missile, which is running far behind its original production schedule; last month, for the first time, the firm delivered more of the missiles to the Navy than the current, revised contract calls for. First deliveries of the Standard—successor to the fleet's "terrible T's," the Tartar and Terrier—began in June in line with the renegotiated schedule.

The original schedule called for full production of the missiles to begin in fiscal 1967, following a three-year development program that included pilot production. GD/Pomona said its problems involved in-house process control and design. The process difficulties were with circuit boards and the manufacture of stripline materials.

## Laser to keep track of missiles

White Sands Missile Test Range held a bidders' briefing Dec. 13 on a laser tracking system that some of the manufacturers believe could take the place of existing optical trackers at the Army range. Based on what the range wants, the cost of the laser tracker is expected to be \$1 million or more. White Sands wants an argon laser system that will track missiles at altitudes ranging from 500 to 15,000 feet. As it stands now, acquisition of the target would be manual. It will not use corner reflectors as do other laser trackers [Electronics, June 27, 1966, p. 48], but will operate with the target painted white.



# New emitter-grid construction used in Amperex RF power transistors brings fail-safe operation to VHF transmitters.

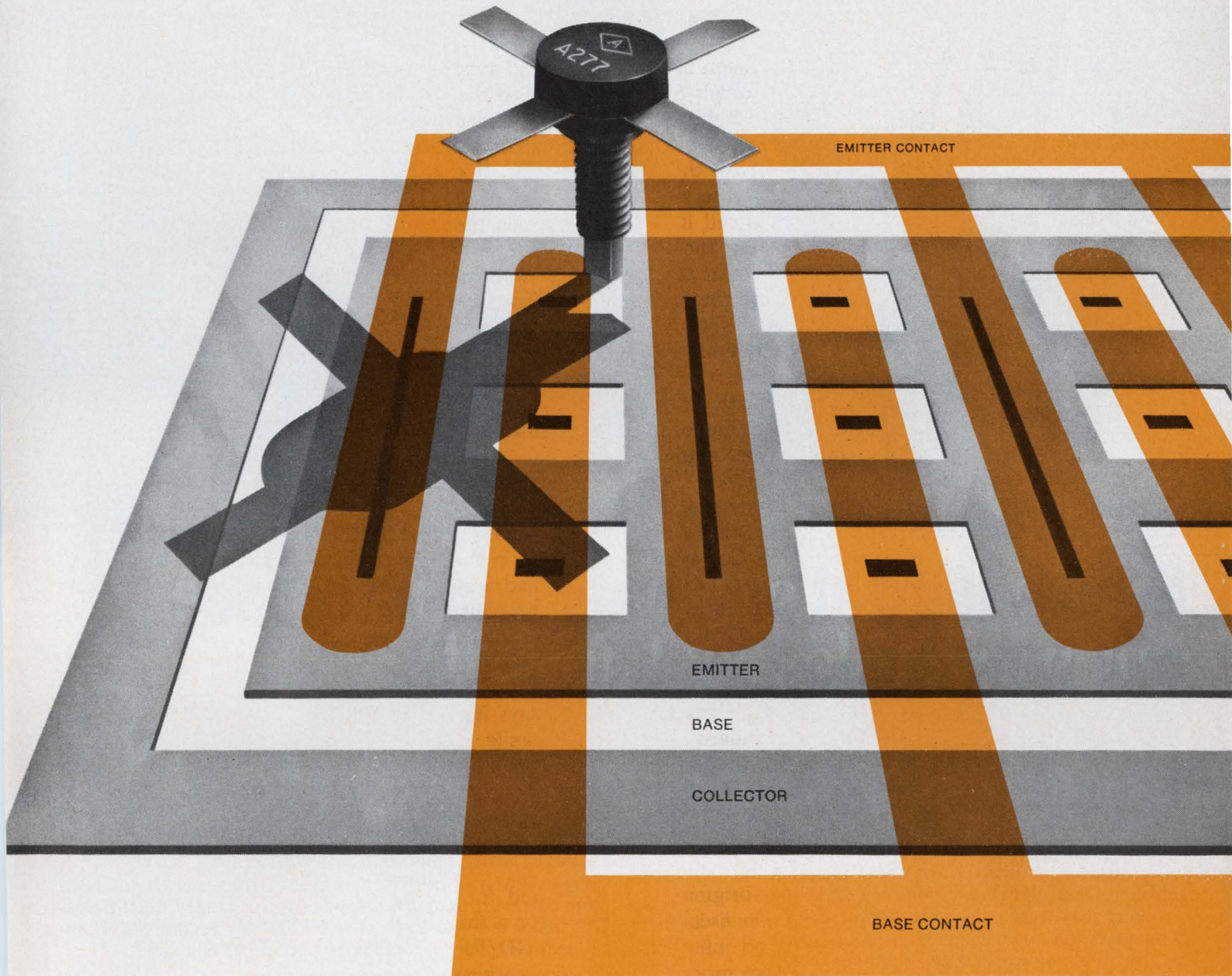

By diffusing the Emitter directly into the Base as a rectangular Grid, we get an emitter periphery equal to the total perimeter of the grid openings, with perfect contact and constant voltage-drop along the entire junction. We then metallize the openings and one set of parallels; the former serve as current-sharing Base contacts, and the latter as Emitter contacts.

This new geometry results in RF power transistors with maximum tolerance for the large overloads typical of power stages in mobile VHF transmitters, virtually guaranteeing fail-safe operation. It also results in high efficiency at high gain and power-handling ability superior to that of overlay

or interdigital devices. Other important advantages include high gain-bandwidth product and excellent linearity.

The first eight devices of the emitter-grid series are the types A270 through A277 for mobile and airborne 175 MHz transmitters. They are available now, in sample quantities from stock. Types A270 and A274 come in TO-39 cases... the others in low-profile, strip-line packages.

The most important parameters are listed at right; for complete data and applications assistance, write: Amperex Electronic Corporation, Semiconductor and Microcircuits Division, Slatersville, Rhode Island 02876.

IMPORTANT PARAMETERS: AMPEREX E-GRID RF POWER TRANSISTORS							
$V_{CE} = 28 V$				$V_{CE} = 12.5 V$			
Type	$P_o$ (W)	G (db)	Eff. (%)	Type	$P_o$ (W)	G (db)	Eff. (%)
A270	3	>11	>55	A274	3	>8	>60
A271	7	>12	>50	A275	7	>9	>70
A272	14	>10	>55	A276	14	>7.5	>70
A273	22	>9	>65	A277	22	>6	>70

**Amperex**<sup>®</sup>

TOMORROW'S THINKING IN TODAY'S PRODUCTS

Circle 35 on reader service card



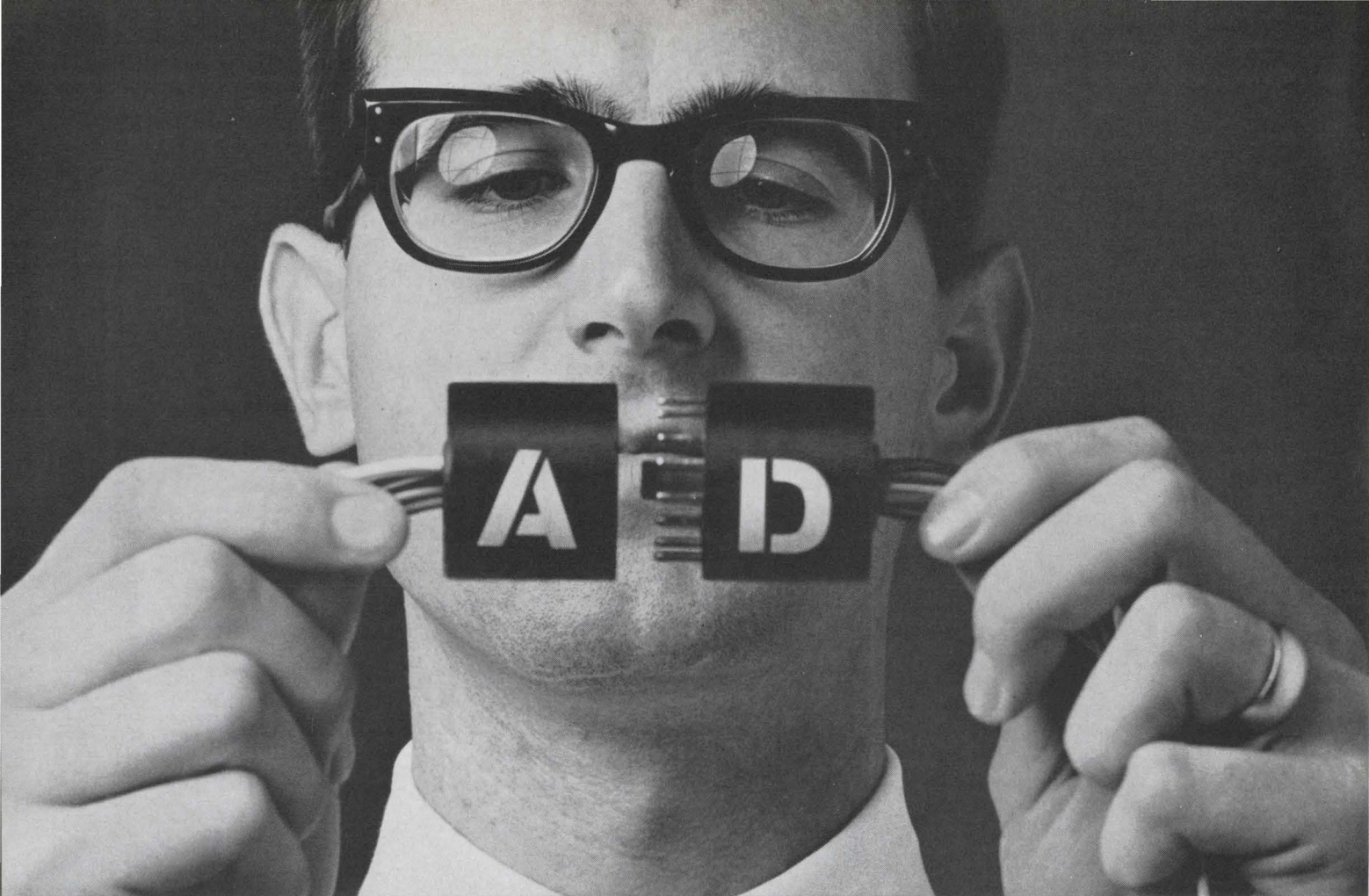

## Even a digital engineer can interface our new analog instruments.

Analog engineers design analog instruments for analog engineers. Digital engineers aren't usually analog engineers. This leads to problems.

Because we're involved with both D and A, we developed a group of instruments everyone can understand and use.

Before they were put on the market, our systems engineers demanded that analog signals get in and out of digital equipment with blinding speed and stunning accuracy. As a result, here are bold statements about our new line: **Our new instruments are:** **A.** As fast and more accurate than . . . **B.** Faster and more accurate than . . . **C.** Almost as fast and just as accurate as anyone else's. Whether **A**, **B**, or **C** applies depends on the instrument you choose.

Here are some of the new ways to get from analog to digital and back again.

### Multi-channel digitizers

64 channel high-level multiplexers with sample and hold amp, plus a 15-bit A-D converter in the same chassis. Accuracy: 0.01%. The MD51 has a sample and conversion time of 10  $\mu$ sec for \$8,250 plus \$200 for each eight channels. If you can spare another 20  $\mu$ sec, you'll save \$3,050 with the MD41.

### Single channel digitizers

15-bit, high-level A-D converters with built-in sample and hold amps. Accuracy is  $\pm 0.01\%$ . The AD51 has a through-

Circle 36 on reader service card

put word rate of 100 KHz for \$5,400. The AD41, though it only costs \$4,000, isn't a slowpoke. Throughput is 33 KHz.

### Digital to analog conversion

The DA40 is a 10-bit, 16 channel D-A converter. If you need more channels, up to 16 DA40's can be ganged together for 256 analog outputs. Each includes address decode and channel controls, plus a power supply. \$375 per channel.

### One of the world's fanciest op-amps

Variations on a theme called the HT58 universal operational amplifier include a single-ended op-amp, differential amp, a unity gain buffer and a buffer with gain, all for use with our "T" and "J" series modules. Input impedance of  $10^8$  ohms and  $\pm 40$  ma. output current over a voltage range of  $\pm 10$ V. Accuracy: 0.01%. Settling time: 5  $\mu$ sec. You can adjust the gain, zero offset, and the input offset voltage temperature coefficient. \$170.

Our spec sheets meet the same requirement as our new instruments: they're understandable by digital engineers, analog engineers, and anyone else who can understand the specs above. For a complete set of spec sheets contact us digitally, or by using Mr. Bell's analog data transmission device.

# SDS

Scientific Data Systems,  
El Segundo, California



## Solid state

### Burnt into a memory

Custom-encoded read-only memories are growing more important in digital hardware for storing tables and microprogramming and for display generators, code converters, and logic controllers. But since most of these applications don't call for high-volume usage, the high initial cost—at least \$400—to make the photomask used to chemically encode the diode-array memory is keeping them from wider use.

To get around this problem, Autonetics has built an engineering model of a pulsed laser system that it believes will lead to low-cost, commercially available custom arrays. The machine burns away selected diodes or diode connections automatically to encode a bit: a connected diode is a 1 and an unconnected or missing diode a 0. This is done by focusing the laser beam either directly onto the wafer or through the sapphire substrate on the metalization.

**Stockpiling?** Autonetics is trying to make the sapphire substrate a part of the package so it can stockpile packaged arrays, encoding them after they're ordered.

One major advantage is that the system also makes functional tests of each diode during the encoding operation.

Autonetics also has done preliminary work with bulk silicon devices, and it appears feasible to use the laser encoding system with them, says Allen Sypherd, one of the developers. "But you have to be more careful with how much energy you use," he adds, since silicon absorbs more energy than sapphire.

Autonetics plans to build an improved model of the system for

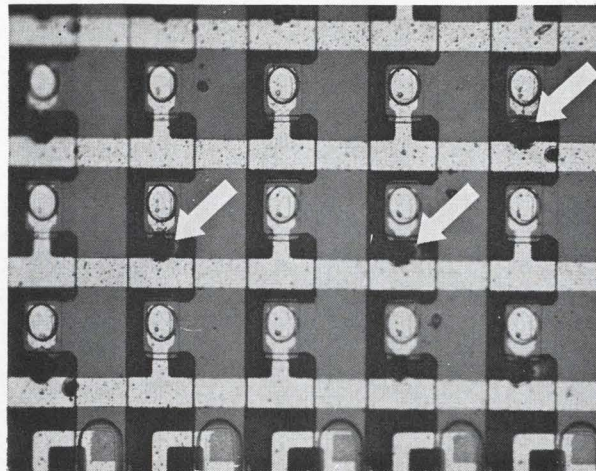

**By rote.** Diode-array memories can be custom-encoded quickly and inexpensively by using a laser to burn out selected diodes or their interconnections.

production encoding of its 1,024-bit silicon-on-sapphire (SOS) read-only memory. And it's now planning to license a company to produce and sell the unit. Sypherd sees it being used in the field for rapid memory changes, resistor trimming, removal of integrated-circuit interconnections and short circuits, and even "unsoldering things."

A "wild guess" on the break-even point is now around 100 memories, Sypherd says. Beyond this, chemical encoding appears to be cheaper, though the production-version laser unit and operator skill could increase the figure. It costs Autonetics less than \$10 to custom-encode one of its SOS read-only memories; it takes about 30 seconds of computer time to produce a punched tape and five minutes of operator time to set up and run the machine.

**No leakage.** Encoding instructions are stored in punched cards that generate the tape to automatically position the laser. The neodymium-rod laser used in the tests is indexed between the diodes—spaced 4.5 mils apart—by a positioner on an x-y table with an accuracy of a 0.1 mil. The laser fires 3- to 6-millijoule pulses, 10 per second, under control of a small

special-purpose computer.

The testing, at 1 kilohertz, takes place before encoding, and, if necessary, afterwards. The aluminum vaporized by the laser beam apparently forms nonconducting compounds—aluminum nitrides and aluminum oxides—so no leakage currents result from the operation.

Within about six months Sypherd expects to complete the speeded-up production system, which will most likely use a yttrium aluminum garnet rod laser so it can operate at 40 to 50 pulses a second. The table speed will be increased from 5 mils to about 250 mils per second. "We're aiming for 2,000 bits per minute," Sypherd says. He estimates that such a system, when offered commercially, might cost between \$15,000 and \$20,000.

## Computers

### Blowup

Start out with an image on a computer terminal's cathode-ray tube; then enlarge it manyfold. What do you end up with? Unless



you've got some very extensive software, the resulting picture will look like pieces of coal scattered in the snow because the enlargement was not accompanied by a gain in resolution.

However, two computer researchers, David C. Evans and Ivan C. Sutherland, in a most unusual business venture, will build a terminal that can manipulate graphics and blow them up 40,000 times without a loss in resolution.

The team has received financial backing from Rockefeller Family & Associates and manufacturing space from the University of Utah, where they teach. Evans, 44, head of the university's computer sciences department, and Sutherland, 30, who left Harvard University to work with Evans, have formed the aptly named Evans & Sutherland Computer Corp.

**First in line.** Their first product will be delivered to an undisclosed customer next summer and will cost about \$100,000.

Central to the display system is a special-purpose arithmetic unit called a clipping divider. A digital unit, it replaces elaborate software previously used in determining the coordinate of points displayed on a screen. The unit further functions by "windowing," which eliminates the portion of display outside the observer's point of view. Sutherland designed the clipping divider with Robert F. Sproull, a former Harvard graduate student of his who is now at Stanford University. Their jointly written paper about the unit was judged the best presented at the Fall Joint Computer Conference in San Francisco early this month.

**Diminishing returns.** Windowing can be performed by blanking the crt when it receives information that lies off-screen. But in that method the computer must still calculate the coordinates of all points whether or not they are displayed. The Sutherland-Sproull unit merely eliminates the off-screen points. This is done by dividing lines into two parts. The division is repeated until one half-line eventually disappears from the window.

The divider has a resolution of 18

bits. Since 10 bits suffice for 1,024-line resolution, the display can be amplified from the 1 square foot of the crt to almost a full acre without degrading the resolution. The remaining eight bits, which are wasted when the whole display is on screen, "fill in" the lines when one small segment of the display is amplified to full-screen size. The resolution is finer than can be achieved with paper and ink, according to Sutherland and Sproull. The system will also include a vector generator (linear interpolator) and a display processor.

Sutherland is working on a head-mounted crt system that would give the user the illusion of being inside a display that uses the clipping divider. His company will presumably build the head-mounted display when it is perfected.

## Consumer electronics

### Getting a peek

CBS Laboratories has been promoting its electronic video recording system for the past year, but except for a handful of people, the

firm has kept the EVR unit under tight security wraps [Electronics, Dec. 9, p. 33]. Finally, at splashy public relations parties in both New York and London, the veil was lifted—a little.

CBS continues to keep many of the technical details secret, but basically this is how it works: EVR involves a technique for converting the optical signals on a special 8.75-millimeter black-and-white film into video signals and then transmitting them through a home tv set's antenna terminals for display on the television screen.

**On the spot.** As it moves at a rate of 6 inches per second, the sprocketless, dual-track film is illuminated by a cathode-ray-tube flying-spot scanner. The modulated light beam is focused on a photomultiplier tube that converts the light signals into video signals. The signals are then amplified and processed to add blanking and sync before they're modulated in an r-f transmitter that operates at the frequency of a vacant channel.

The deflection system that controls the vertical and horizontal scanning is similar to that of a standard tv receiver. The vertical sweep is initiated and controlled by a free-running, 60-hertz multi-

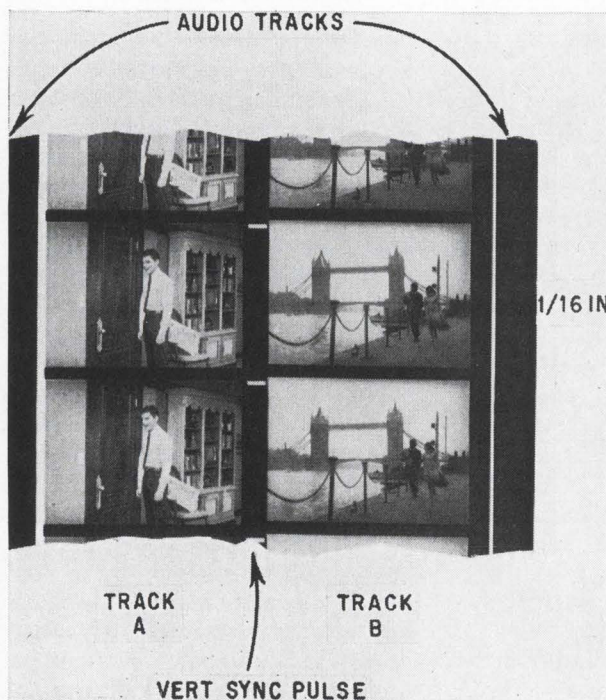

**In view.** Two-track film used in CBS electronic video recording. The little white rectangles between the frames provide vertical sync pulse. Each frame is only 1/16 inch wide.



# Piggy Bank Pac

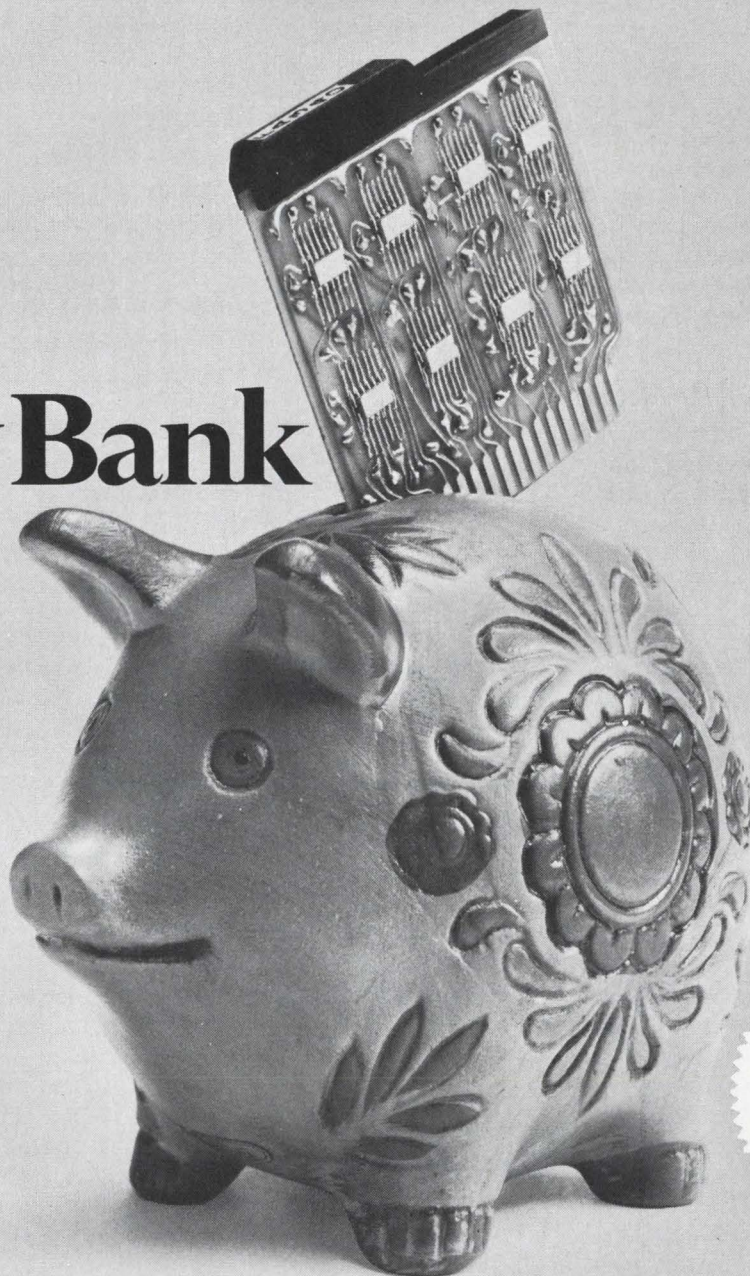

$\mu$ -PAC logic module prices have been reduced. Again. It brings us close to our objective: to provide the most comprehensive and economical digital logic offering in the industry. First, take a look at some typical prices:

Model	Description	Unit Price		New Price per Function
		Old	New	
DI-320	10, two input NAND gates	\$25.00	\$20.00	\$2.00/gate
DN-320	6, three input NAND gates	21.00	16.00	2.66/gate
DF-320	8, three input NAND gates	New	20.00	2.50/gate
FF/320	8 basic flip-flops	New	31.00	3.87/flip-flop
FA/320	4 clocked flip-flops	31.75	25.00	6.25/flip-flop
BC-320	6 stage binary counter	46.50	38.00	6.33/stage
SR-321	8 stage shift register	New	54.00	6.75/stage
AP-335	8 half adders	168.00	129.00	16.12/half adder

We'll give you 102 more price comparisons on request.

Now, focus on those factors most often neglected in a make-or-buy go 'round.  $\mu$ -PAC modules offer the lowest total system cost because they are more than "a flip-flop mounted on a card."  $\mu$ -PAC modules are an

integrated system of digital logic electronics with fully compatible mounting hardware and power supplies. I/O circuits and analog circuits. Wire wrap tools and other accessories. The works. Plus support. Like in-depth documentation. Logic design aids. 100% circuit testing. 72-hour Certified Fast Shipment. Even custom designs for your special needs.

Whether your logic needs are large or small, ask your Honeywell PAC man to give you the full story. He'll help you "bank" a nice piece of change. Honeywell, Computer Control Division, Old Connecticut Path, Framingham, Massachusetts 01701.

**Honeywell**  
COMPUTER CONTROL  
DIVISION



vibrator that's synchronized by vertical sync pulses picked off the film. The horizontal sweep is controlled by a 15,750-kilohertz oscillator that generates the voltage for the crt through a flyback transformer.

The audio signal from the program material is magnetically recorded along the outer edges of the dual-track film and is picked off by a standard audio playback head. After amplification and equalization, the audio is frequency-modulated in a 4.5-megahertz modulator and fed to an r-f unit that converts it to the channel's carrier and audio frequency signal.

A key to the development was the company's technique for producing the film. CBS uses an electron-beam recording system much like its Linotron printer [Electronics, April 3, 1967, p. 113] and the photo-reconnaissance scheme it developed for the military [Electronics, Jan. 25, 1965, p. 36]. But just why the company turned to this technique, rather than to conventional optical methods, isn't clear. One possibility, however, is that when CBS has EVR units capable of projecting color pictures from black-and-white film (see next story), it will be more convenient to place the color coding on the film with an electron beam. Also, reproduction is faster with an electron beam than with a start-and-stop optical technique.

**Two for the show.** The EVR player will be produced and marketed in the U.S. by Motorola and in Europe by Rank-Bush Murphy, a subsidiary of the Rank Organisation of London, under special licensing agreements. Motorola says its player will be on the market in 1970 at a price below \$800. But Rank-Bush Murphy expects to sell its unit for under \$500.

CBS sees a big consumer market for EVR when home-entertainment films become available. But for the time being, sales efforts will be aimed primarily at educational institutions, suppliers of audio-visual programs, videotape libraries, and the publishing and motion-picture industries.

### **Good grief, another breakthrough!**

For the second time in as many months, the New York Times has given front-page coverage to a scientific "breakthrough." And once again, both the timeliness and significance of the event reported are doubtful.

Last week the Times reported that CBS Laboratories had achieved a breakthrough by developing a way to produce color movies with black-and-white film. The newspaper failed to note that the technique was announced by CBS last year [Electronics, Sept. 4, 1967, p. 25], and that other research firms had previously devised methods of doing the same thing [Electronics, Jan. 23, 1967, p. 235; July 10, 1967, p. 193].

Last month the Times, along with several other newspapers, heralded the advent of Stanford Ovshinsky's glass semiconductors [Electronics, Nov. 25, p. 49], experimental devices that had been described in the technical press years before [Electronics, Sept. 19, 1966, p. 191].

---

### **Space electronics**

---

#### **Viking is here**

The National Aeronautics and Space Administration suffered a sharp setback last year when, in trying to pump new life into its unmanned interplanetary exploration program, it asked for \$20 million to start work on two Mariner-Mars 1973 missions. Congress responded to the plan by slicing the agency's request to about \$4 million. The rebuff was doubly galling because the year before Congress had scuttled NASA's very large Voyager-Mars program.

Well, the space agency is now readying itself for its third turn at bat. Its new proposed program, called Project Viking, is smaller than Voyager but larger than Mariner-Mars (or Titan-Mars '73—its hybrid version). The request for

Viking in the January budget will be about \$50 million; the total cost of the program will run to \$325 million.

**Double duty.** The project will consist of two Titan 3D boosters and two 6,000-pound spacecraft. Each spacecraft, in turn, will consist of a Surveyor-type soft lander and a Mars orbiter. Upon arrival at Mars, the orbiters will determine landing sites and dispatch the soft landers. The orbiters will observe surface changes on the planet, measure water in the atmosphere, and determine what storms and other meteorological phenomena occur. Their companion landers will perform the same checks on the ground, as well as searching for biological activity.

Straightened finances have kept NASA's interplanetary activities down to an occasional mission for the last year or so and will continue to do so for a few more years. However, NASA would like to get the exploration program going again and the hope is that Viking will provide a start. Among the visions in the heads of the interplanetary probers at NASA: a mid-1970 Jupiter flyby; multiplanet flybys in 1973, 1975, 1977, and 1978; major Mars missions in 1975 and 1977, and assorted small atmospheric probes and advanced Pioneer missions.

---

### **Communications**

---

#### **Hands-off attitude**

The regulation of teleprocessing services has caused a special problem for Federal authorities. Almost everyone agrees that computers themselves need not be regulated, but when computers and users are linked by regulated communications circuits, a new situation arises. And the President's Task Force on Communications Policy has concluded that competition in an unregulated marketplace would be in the national interest.

The Federal Communications Commission is wrestling with the



Pick the  
**BEST** IC  
for the job

**Problem:** Four DC to 30 kHz signals from high impedance sources must be summed into a  $2k\Omega$ , 100 pF load. The output is to be a guaranteed minimum  $\pm 12$  volts over the full frequency and military temperature range. The logical choice would be a Radiation RA-909. But amplifier offset current drift must not exceed  $2 \text{ nA}/^\circ\text{C}$ . Pick the Best IC for the job.

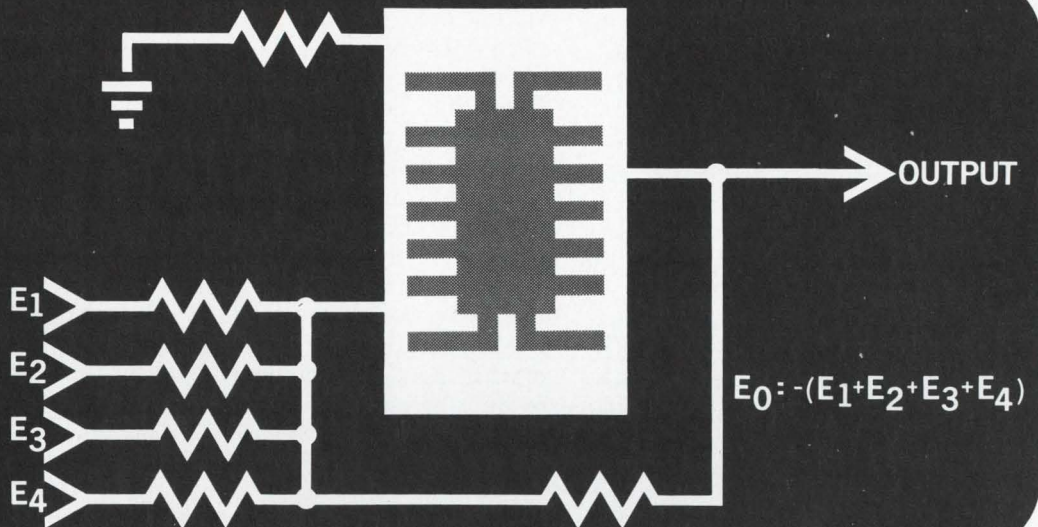

the **BEST** Solution:

### THE NEW RA-909A COMPENSATIONLESS OPERATIONAL AMPLIFIER

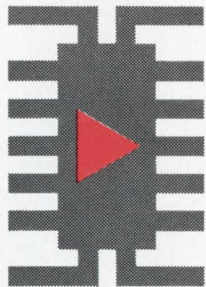

Drift error is very low in the new dielectrically isolated compensationless RA-909A. Between  $-55^\circ\text{C}$  and  $+25^\circ\text{C}$  offset current drift is a low  $2 \text{ nA}/^\circ\text{C}$ . From  $+25^\circ\text{C}$  to  $+125^\circ\text{C}$ ... an even lower  $0.5 \text{ nA}/^\circ\text{C}$ ! And Radiation guarantees less than  $15 \mu\text{V}/^\circ\text{C}$  offset voltage drift over the military temperature range. Compare this performance with any 709 type op amp over this extremely wide operating frequency range. You'll pick the Best op amp for the job. The RA-909A.

Like the RA-909, no external compensation is needed. Dielectric isolation and good circuit design eliminates the need for compensation. The RA-909A is in both a TO-99 package and a TO-86 flatpack configuration. A direct replacement for 709 type op amps.

Contact your nearest Radiation sales office. Let us help you pick the Best IC for the job.

WE MAKE THE **BEST** IC FOR THE JOB

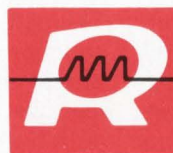

**RADIATION**  
INCORPORATED  
SUBSIDIARY OF HARRIS-INTERTYPE CORPORATION  
MICROELECTRONICS DIVISION

RADIATION SALES OFFICES: P.O. Box 476, Lexington, Mass. 02173, (617) 682-1055 • 600 Old Country Road, Garden City, N.Y. 11530, (516) 747-3730 • 2600 Virginia Avenue N.W., Washington, D.C. 20037, (202) 337-4914 • 6151 W. Century Boulevard, Los Angeles, California 90045, (213) 670-5432 • P.O. Box 37, Melbourne, Florida 32901, (305) 727-5430 • International Sales: Marketing Department, P.O. Box 37, Melbourne, Florida 32901, (305) 727-5412



same issue, and the commissioners may be influenced by the task force's report, which is part of an over-all study on communications policy [Electronics, Nov. 25, p. 58, and Nov. 11, p. 34].

The report urges the removal of Governmental restrictions on the sharing of communications lines, on the splitting for resale of channels, and on message switching.

It takes the position that users of teleprocessing services, being technically sophisticated, can guard against harm to the entire telephone system—something the phone company says it fears.

**The choices.** Three basic propositions were before the task force:

- Allow the common carriers (mainly AT&T and Western Union) to have exclusive control over all business that combines message switching with data processing.

- Maintain the status quo and prohibit teleprocessors from switching messages.

- Allow teleprocessing companies to switch messages when this is related to teleprocessing services.

The task force chose the third. This represents a major victory for the data processing companies that support a proposal to bar companies leasing circuits from letting customers use them primarily for their own regular communications. The customers would be free to use them to communicate among each other as long as the lines were primarily used for data processing.

There are objections to this plan. For example, how do you determine whether circuits are being used primarily for a given purpose? Also, some small data processing companies might refrain from offering the best teleprocessing service or hesitate to innovate out of fear that the communications part of the communications-processing mix would be too high.

The task force also jumped into the argument over the patentability of computer programs [Electronics, Dec. 9, p. 52]. It suggests a novel compromise: provide protection against copying and reselling a computer program but allow persons or firms to copy programs freely for their own use.

## Military electronics

### Raising Cains

The winner of a fierce tug-of-war between aircraft manufacturers and some Navy administrators is expected to be decided early next month when the Naval Air Systems Command decides which way to fund development of the \$250 million aircraft inertial navigation portion [Electronics, Oct. 30, 1967, p. 44] of the Carrier Aircraft Inertial Navigation System (Cains).

The decision is whether the inertial navigation systems will be subcontracted by the individual aircraft makers for each type of plane or built by a single contractor, who will then produce the systems as Government furnished equipment (GFE) for the several types of planes. An earlier report [Electronics, Dec. 9, p. 34] that the Government itself would modify existing gear was incorrect.

Since the goal of Cains is aircraft commonality, some Navy people want the GFE approach, but they are running into stubborn opposition from airframe makers and are hampered by low funds. If necessary, they prefer that Government R&D money be used to build the first production items GFE. Either way, they contend that Cains standard specifications will prevail, but they concede they will have less control if the individual aircraft manufacturers are responsible for the system.

**Uses radio.** Cains, designed to be the fleet standard for the 1970's, is a shipboard system that aligns, within five minutes via radio line, an aircraft's inertial navigation using the carrier's inertial system. Making use of as much available equipment as possible, Cains consists of five development areas, the first three of which are being developed mostly by the Navy in conjunction with other programs. The three are: developing shipboard inertial navigation digital systems to interface with the aircraft, interfacing the radio link between the ship's computer and the aircraft, and providing computer programs to handle the job automatically.

Requests for proposals to develop the aircraft inertial navigations system are expected next week and are due back the end of next month. A contract will probably be awarded sometime in February [Electronics, Sept. 30, p. 63]. The units are slated to go aboard the upcoming VSX, VFX, and E2-C airplanes. As many as 3,000 production units may be built over five years if the Navy decides to retrofit. The units would cost between \$80,000 to \$98,000 each.

### Alarming vibrations

The idea of posting electronics sentries around a military encampment isn't a new one. Up to now, however, most anti-intrusion devices have been too bulky to carry around, have usually had to be wired to a receiver, and, more importantly, have had the habit of "crying wolf"—confusing, say, the sound of a helicopter's rotors with the clamor of an advancing enemy platoon.

But the Sylvania electronic systems group has developed a detection system that's both highly portable and discriminating. Called Guard Post, it employs up to 16

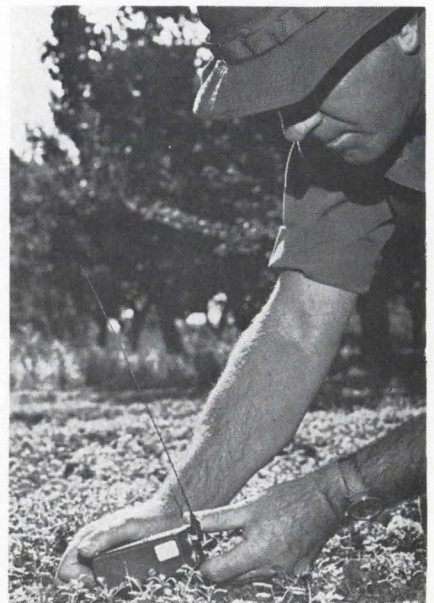

**On guard.** Sylvania's tiny electronic sentry can detect tiny vibrations caused by footfalls.



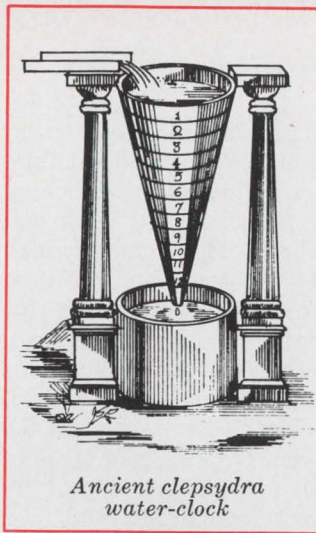

Ancient clepsydra  
water-clock

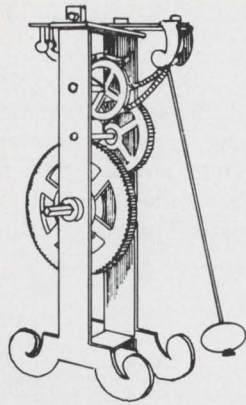

Galileo's proposed  
clock pendulum



E-CELL  
Timing  
Component  
Actual Size



# HOW TO PUT A CLEPSYDRA IN YOUR TIMING CIRCUIT

Don't laugh.

In the 16th Century, princes of political power, learning, and religion didn't laugh when Galileo demonstrated the principles of free-fall using a clepsydra as his timing device.

It is a curious truth that men have always found it satisfying to think of the "passage of time" as a constant-current phenomenon. So, for more than three thousand years—from the 1500's B.C. to the 1500's A.D.—clepsydras of simple and marvelous design poured out their calibrated streams of water, milk, mercury, and other fluids to simulate the "passage" of time. The phrase, "one clepsydra granted", was often heard in Athenian Courts to denote how much more time a lawyer could have to extend his pleading before a tribunal. This practice introduced a new concept, the **time quantum**—although that way of saying it probably didn't occur to anyone for the next two thousand years, until the era of Max Planck.

But the physics of timekeeping (like, alas, so much of modern existence) grew more complex in the era of mechanisms. The thrust was always to subdivide the passage of time into ever smaller, and scientifically more useful, units. Galileo's suggested application of the pendulum to timekeeping was the beginning of the new mechanical era. Still, a "second" was not "created" until one of those rare universal scientific minds, Christiaan Huygens, perfected the mathematics of the cycloidal pendulum and invented the cycloidal regulatory spring—which has served as the "intelligence" of mechanical clocks for the past three hundred years.

Today, for the specialist and layman alike, to speak of timing devices is to evoke images of springs and gears and ratchets and pinions and balances and escapements—intricately enmeshed and delicately poised so as to simulate the "passage of time" and divide it up into the smallest possible units, each "tick" or "tock" announcing the departure of the last moment and the arrival of the next in an eternal time continuum.

Inevitably, deepening understanding of atomic physics in our Century has brought about fundamental changes in the ways we calibrate the "passage of time". Exotic timekeeping devices based on stimulating atomic oscillations do indeed achieve near-perfect accuracy and stability, but at the expense of simplicity, convenience, and dollars.

To meet the need for a practical, mass-produced, low-cost timing device that takes advantage of atomic-scale effects, Bissett-Berman has developed the unique family of E-CELL components. Every physical function in an E-CELL unit is reduced to elementary simplicity. The "passage" of time (minutes to months) is noted by a constant electric current which transports small masses of silver from one electrode to another. True to Faraday's electroplating laws, for every electron impressed on an E-CELL component, exactly one atom is transported between electrodes. Within its tiny container, an E-CELL unit thus combines functions normally done by electromechanical oscillator and counter assemblies.

Of special importance to designers of control systems is the fact that an E-CELL timer is not a clock, in the traditional sense of measur-

ing and visually displaying the time continuum as an independent "natural" phenomenon. Each E-CELL component is a miniature time capsule that will deliver a useful electronic output signal at the end of a pre-set **real-time quantum**. The circuit designer can specify the **real-time quantum** as conveniently as he selects a resistor and can wire it directly into his circuit.

It should not be inferred that an E-CELL timer is a fragile flower of the instrumentation laboratory. In contrast to the notorious volatility of electron charges accumulating on the plates of a capacitor, the silver atoms in an E-CELL component are electrically neutral, and hence very stable. E-CELL timers have continued to work even after being dropped from airplanes onto hard surfaces, and have passed rigorous military field tests for environmental tolerance.

Shouldn't you be looking into the unique properties of E-CELL timing and integrating components?

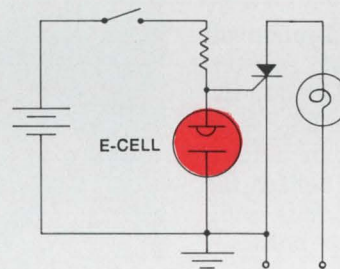

Basic-E-CELL  
Timing Circuit

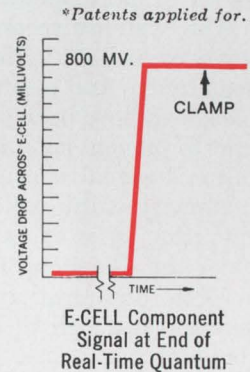

### Want more information?

For technical information and application notes, please send in the coupon below.

**BISSETT  
BERMAN**

COMPONENTS DIVISION  
Los Angeles, California

The Bissett-Berman Corporation, Components Division  
3860 Centinela Ave., Los Angeles, Calif. 90066

LITERATURE ONLY  HAVE REPRESENTATIVE CALL

APPLICATION \_\_\_\_\_

NAME \_\_\_\_\_

COMPANY \_\_\_\_\_ DEPT. \_\_\_\_\_

STREET \_\_\_\_\_

CITY \_\_\_\_\_ STATE \_\_\_\_\_ ZIP \_\_\_\_\_

C1268-BS



small sensors that can be placed around a camp to detect earth vibrations caused by walking, creeping, or crawling intruders.

**Belt-borne.** The sensing unit measuring only 3.5 by 2.5 by 1.5 inches, consists of a small geophone, a radio transmitter that broadcasts at 100 to 150 megahertz, and a collapsible foot-long antenna. The units are so small that two of them fit into an ammunition pouch.

The geophone, which picks up the vibrations, sends a signal through what William D. Barkhau, marketing manager for Sylvania's security systems organization, calls "a complex bank of multibandpass filters." The geophone picks up all vibrations within a 75-foot radius, but the filter network is keyed to discriminate between the sounds of an intruder and other noises such as rain, thunder, and the clatter of low-flying aircraft.

When it detects a certain combination of sounds, the filter network triggers a set of logic circuits that actuate the transmitter. This 100-milliwatt unit, can send a signal 1,000 feet in dense, wet jungle, estimates Barkhau, and several times as far in more open country.

The system's receiver, 4 by 4 by 6 inches, is built with a 1-microvolt sensitivity. And electronic countermeasures have been included in the unit to prevent jamming. The transmitter's signal consists of a four-bit binary word, which defines the reporting sensors and thus indicates the direction of the noise.

With no intruders in range, a sensor draws so little power that its four mercury cells keep it watchful for 10,000 hours or more. Even if it's reporting continually, says Barkhau, the sensor can operate for about 4,000 hours.

**Selling job.** Sylvania's chances of selling the system to the military depend on the company's ability to prove that Guard Post is both easy to use and cheap enough to abandon if necessary. Barkhau says the detection units themselves will cost "in the low hundreds of dollars," but he asserts that this is a relatively modest amount considering that most of it is accounted for by the filtering network, which cuts

down on false alarms.

Sylvania has also built the sensor into a rifle grenade casing, converting the grenade's tail into an antenna. Thus the sensor could be fired into areas where manual planting could be dangerous.

---

## Avionics

---

### Talking by the numbers

Commercial airline pilots would probably concede that they talk too much on the job. Routine communications—reporting when they leave the passenger gate or when they land or their flight number and position—take up time and clog the airwaves. In the future, much of this talk will be replaced by digital signals sent in a fraction of the time over the regular communications links, according to B.F. McLeod, director of electronic engineering for Pan American World Airways.

Pan Am began experimenting with just such a link, called Digicom, early this month when it

began sending not only flight information but also engine-maintenance data digitally from a Boeing 707 flying between New York and the Caribbean. The signals, which include the flight number, position, and performance parameters for the four engines, were beamed over a very-high-frequency link to the ground and then to Pan Am's headquarters. The system sends in 0.6 second what would take a pilot more than a minute to report by voice, according to McLeod.

**Pre-Apollo.** General Electric, Binghamton, N.Y., supplied the engine-sensing equipment, which it had originally developed in connection with the Apollo program. Bendix, Ft. Lauderdale, Fla., developed the Digicom gear that encodes the data.

Pan Am hopes to have a fully operational system, automatically sending a much greater range of in-flight data, ready when its 747 fleet takes to the air late in 1970. By then the system could be tied to the ground through vhf satellites. Still further away is the possibility of using satellite links at L band.



**Neither rain nor fog . . .** A small Metuchen, N.J., firm, Laser Diode Laboratories, has built a 15-pound laser viewing system that can "see" through up to 300 feet of rain, fog, sleet, or snow. The optical radar system's gallium arsenide laser emits short bursts of infrared pulses that reflect off the target and illuminate the system's photocathode. To overcome the problem of backscatter—in which light reflected by moisture particles obscures the target's image—the firm uses gated viewing; the pickup tube operates only when the return pulse is expected. To pick out a target, the operator sweeps a timing device that adjusts the interval between the emitted laser pulse and the on time of the photocathode. The reflected image is reproduced on the system's small cathode-ray tube. The hand-held unit is expected to sell for less than \$3,000. The firm plans to design longer-range units for ground and air vehicles.



what do  
**USC REMI\***  
 Connectors  
 have up  
 their  
 sleeve?

No magician ever did as much with his sleeve as you could with REMI sleeve-fitted closed entry crimp-type contact connectors.

The unique REMI sleeve accepts either male or female **contacts** in either male or female insulator **bodies**. Both male and female spring phosphor bronze contacts snap easily into and out of specially heat-treated beryllium copper sleeves. Mechanical stresses are confined between **metallic** elements. All contacts ride in **metal** sleeve only. Alignment is automatic, yet precise, thanks to meticulous U S C design and construction.

No. of Contacts: 7, 14, 18, 20, 21, 26, 34, 41, 42, 50, 75, 104, 123, 150, 225.

Wire Sizes Accommodated: AWG #14 to #30 and MIL-W-16878A #16 to #32. REMI contacts are ordered separately. Crimping by MIL-T-22520A (WEP) Class I or II tools.

Military Specifications: (Contacts) MIL-C-23216, MIL-C-26636, MS3190. (Connectors) MIL-C-8384, and MIL-C-25955. (Latest Revisions).

U. S. Patent Nos. 2,761,108; 2,979,689 & Five International Patents.

We'll be glad to show you what we've got up our sleeves. Write today for REMI-A catalog and avail yourself of U S C E.R.\*\*

\*REmovable, REentrancy, Miniature Connector

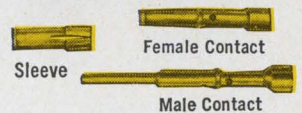

\*\*U S C Established Reliability can do!  
 1320 ZEREGA AVENUE • BRONX, N.Y. 10462  
 or use TWX: 710-593-2141 • Tel. 212-824-1600  
 TELEX: 1-2411 • or Cable: COMPONENTS N.Y.K.

Circle 45 on reader service card



# IT'S SUPERFLEXIBLE

a  
new kind  
of  
HELIAX®

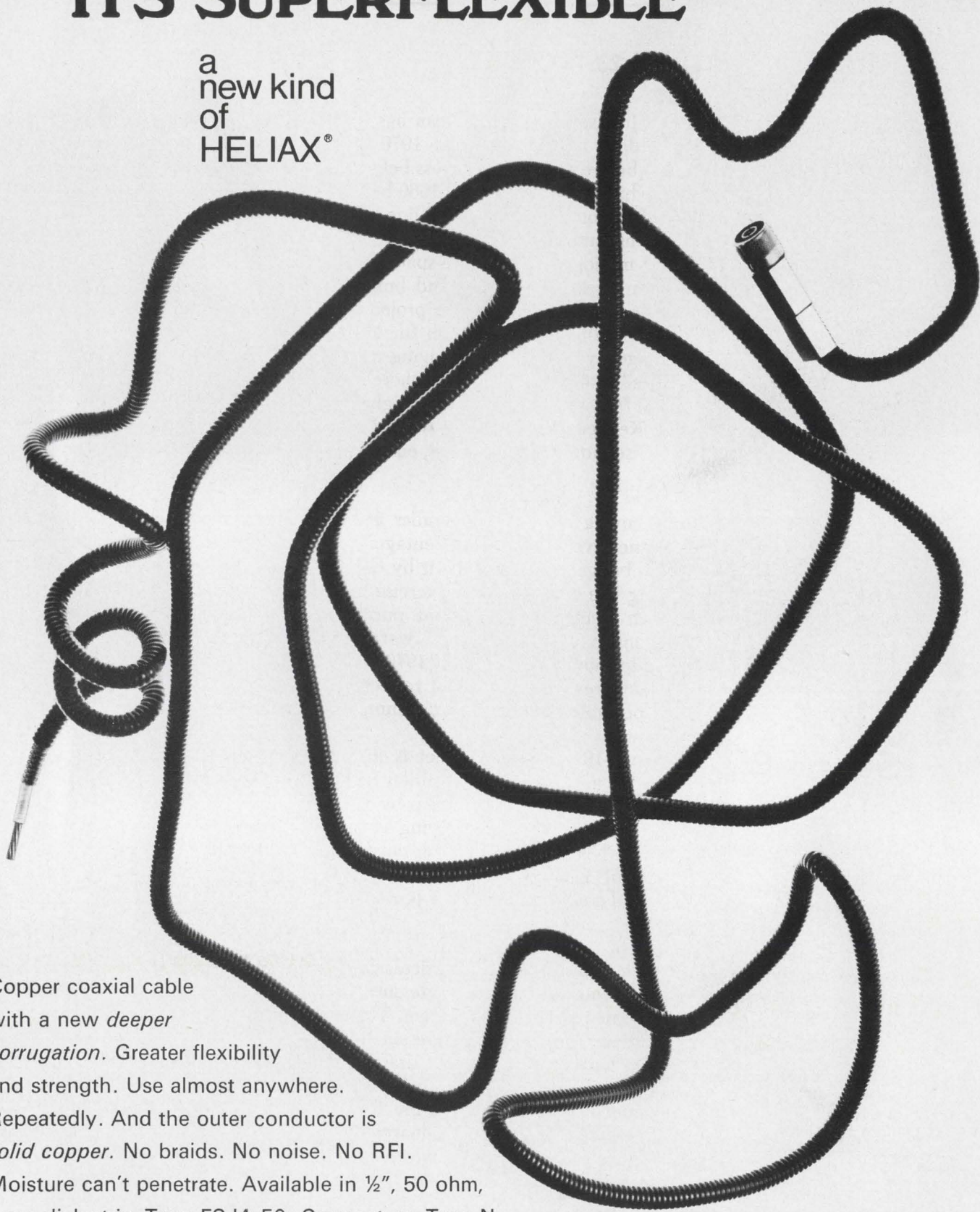

Copper coaxial cable with a new *deeper corrugation*. Greater flexibility and strength. Use almost anywhere. Repeatedly. And the outer conductor is *solid copper*. No braids. No noise. No RFI. Moisture can't penetrate. Available in 1/2", 50 ohm, foam dielectric, Type FSJ4-50. Connectors, Type N or GR-874. Like a sample? Communicate with Andrew.

12-68

 **ANDREW**

CONTACT THE NEAREST ANDREW OFFICE OR ANDREW CORPORATION, 10500 W. 153rd STREET, ORLAND PARK, ILLINOIS 60462



# Washington Newsletter

December 23, 1968

## **NASA hopes Nixon can save '70 budget**

President Johnson's Budget Bureau has severely chopped the \$4.5 billion NASA budget request for fiscal 1970. It now appears that the space budget to be presented to Congress before Jan. 20 will total \$3.875 billion—only a whisker above the final 1969 budget of \$3.85 billion.

In the Johnson budget is \$1.6 billion for Apollo, \$345 million for Apollo Applications, and \$39.4 million for the Nerva 2 nuclear rocket program. The \$550 million requested for space science and applications includes \$18 million to start designing and building the Earth Resources Technology Satellites, \$50 million for project Viking, formerly Mariner-Mars 1973 [see p. 40], and \$45 million for Mariner-Mars 1971.

Space agency officials aren't giving up yet. The \$3.875 billion budget is only the "first" budget to them; there's much in-house speculation that the Nixon "second" budget will be higher. They hope for a "Nixon save" like the "Kennedy save" in 1961 when President Kennedy pumped funds into the Eisenhower space budget, enabling NASA to really start growing.

## **Pentagon buying won't slow down**

Military buying from the electronics industry shows no sign of dipping over the next year or so. The Pentagon recently finished allocating the \$3 billion budget cut forced on it by Congress, but the reductions wind up looking like a bookkeeping exercise "for show only," with little or no impact on electronics equipment purchases in the long run. This is because much of the "savings" were simply pushed ahead and are expected to show up in the fiscal 1970 budget. And more than making up for the Congressionally ordered reduction in the over-all total will be what is becoming the Pentagon's annual supplemental request for the Vietnam war.

The fiscal 1970 defense budget is shaping up at around \$82 billion—largest ever, and up about \$3 billion from 1969. This more than makes up for reductions achieved this year by not restocking inventories, stretching out procurements, and delaying some new projects. And it could go higher. The Nixon Administration must decide soon whether to proceed with several new large programs; the Advanced Manned Strategic Aircraft and a new generation of ICBM's are two examples.

## **Volpe faces push on better air safety**

The Nixon Administration—particularly Transportation Secretary John Volpe—will come under heavy pressure next year to drastically improve the FAA's air traffic control system. The Wednesday group of 26 liberal and moderate Republican Congressmen will apply most of the pressure. The group has just read the first draft of a staff study on air safety.

The final report, which won't be made public for several months, will pull no punches in condemning the FAA as a "detriment to air safety" that has created "aeronautical anarchy." The report will demand that NASA, as well as the FAA, move quickly to improve air traffic control and to get all-weather navigation, landing, and collision-avoidance systems into operation.

## **Weather 'birds': plans are hatching**

Several low-level studies are being made by NASA and ESSA and by outside contractors to define future meteorological satellite programs. These efforts will be expanded next year, though they probably won't



---

# Washington Newsletter

---

appear as separate line items in the fiscal 1970 budget.

Some of the new projects are: a follow-on Tiros, a polar orbiting operational satellite for the early 1970's; several advanced Nimbus craft; the World Weather Watch satellites, planned for first launch in 1973; and a stationary-orbit Meteorology System Test Satellite.

Borrowing heavily from the Applications Technology Satellite design, the Meteorology System Test Satellite would be part of a developmental effort aimed at building an operational, stationary-orbit weather satellite. **This large "omnibus" craft is now being considered for operation in the mid-to-late 1970's;** the prototype test satellite would be launched in the 1972-1974 period.

## Springtime for Awacs

Boeing and McDonnell Douglas will submit their proposals Dec. 31 for the contract definition stage of the Airborne Warning and Control System (Awacs). **The Air Force Systems Command is expected to award the contract to build the flying command post late next spring.** Although the definition stage had been cleared some months earlier [Electronics, Sept. 30, p. 54], end-of-Administration traffic delayed issuance of requests for proposals until this month.

## Biosatellites in for a boost

Officials of NASA's small biological science program are pushing for a major increase in activity, including an extensive series of Biosatellites for the early to mid-1970's. They've inaugurated a half-dozen low-funded studies to define a list of projects. While not all the projects will be funded to completion, **it does look as if the space agency's low-priority bioscience program is in for a spending boost.**

Additional versions of the present generation of Biosatellites are planned for the early 1970's (four satellites are now scheduled), as are improved Biosatellites with increased reliability and enlarged payload capacity. An even larger 4,000-pound advanced Biosatellite is being considered for studying the long-term effects of space on biological specimens.

**A two-mission Biopioneer program and a pair of Bioexplorers, all for the 1972-1973 period, are also on the drawing boards.** The Biopioneers would study the gravity requirements of plants and animals, while the Bioexplorers would study effects on biological specimens outside the earth's gravity field.

Being studied in addition to the unmanned satellites are Biotechnology Laboratories—a series of experiment packages to go aboard manned orbiting space stations being planned for the mid-1970's.

## Addenda

Sales of cable television equipment could slow sharply as a result of the FCC's controversial proposals to limit the importing of distant signals into top markets by CATV and to require cable systems to originate some of their own programs. The FCC, which will hold hearings on the proposals in late January, will probably end up following directions from Congress or the courts on the issue . . . . By approving the start-up of pay tv in June, the FCC could be improving the business outlook for manufacturers of encoding/decoding equipment. Operators of the pay-tv systems will lease decoders to subscribers. This issue, too, will wind up in the hands of Congress and the courts, with the basic question being whether airwaves are "free."



# The biggest up-down counter news in a decade

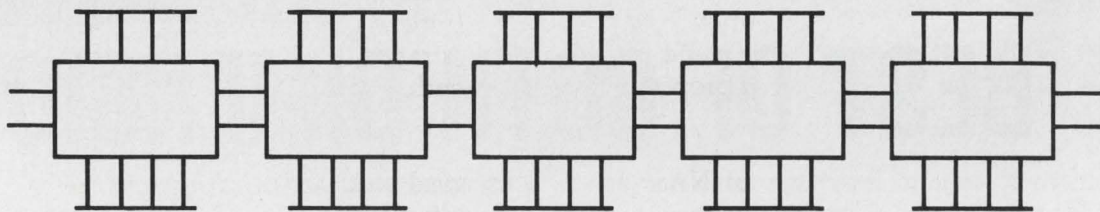

(also in a binary)

You can add decades forever without ever adding additional logic circuitry. Simpler circuitry and faster too. Our new monolithic up-down counter series are pre-settable, synchronous and packaged in 16 pin Dual In Lines, the same pin configuration for both decade and binary. Completely compatible with the popular TTL series 54/74.

Full temperature range  $-55^{\circ}$  to  $+125^{\circ}\text{C}.$ , the decade DM7560 and the binary DM7563 are priced at \$36.50 in hundred quantities. Both are available in the commercial/industrial  $0-70^{\circ}\text{C}.$  temperature range, decade DM8560 and the binary DM8563 at \$21.00 in hundred lots.

In total TTL, National leads again with MSI circuits of advanced complexity. Write for the total TTL story. National Semiconductor, 2975 San Ysidro Way, Santa Clara, California 95051 (408) 245-4320 TWX: 910-339-9240.

Cable: NATSEMICON

# National

# TTL



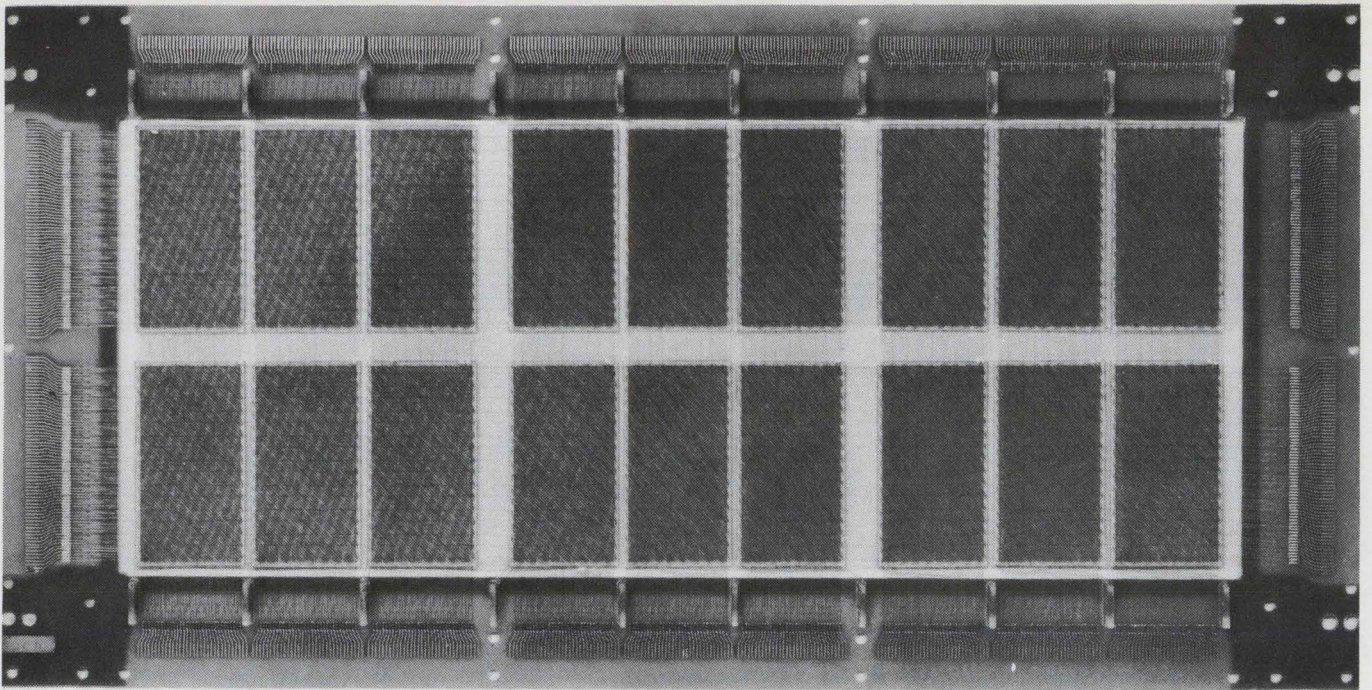

# THE BEST OF BOTH DIMENSIONS

Here's a 2½D core memory array that combines the advantages of 2D and 3D types. It makes possible a whole new generation of computers. Advanced manufacturing techniques developed by Hitachi produce the tiny 16-mil cores. This assures high reliability coupled with low cost. Hitachi's PE0903 Memory Array features a memory cycle of only 420 nano-seconds. It consists of HFC158 cores arrayed 128x64x18 and is intended for use in memory systems operating in an ambient temperature range of 0 to 45°C. It's designed to permit direct plane-to-plane stacking. And it's available right now. Other types are in production and special-purpose memory arrays may be ordered.

## RESPONSE CHARACTERISTICS:

Temperature .....	25 ± 1°C
"Read" Pulse .....	400 mA
"Write" Pulse .....	400 mA
Strobe "1" (min.) .....	30 mV
Strobe "0" (max.) .....	8 mV
Peaking Time (av.) .....	90 nsec.
Switching Time (max.) .....	170 nsec.

## HITACHI MEMORY CORES (Coincident Current Type)

Core Material Classification	OD (mils)	Core Type	Typical Operating Conditions at 25° C						
			Drive Current Conditions			Output Signals			
			$I_f/I_d$ (mA)	$t_r$ (μ sec)	$t_w$ (μ sec)	DV <sub>1</sub> (mV)	DV <sub>z</sub> (mV)	$t_p$ (μ sec)	$t_s$ (μ sec)
Conventional Standard	50	H 5031	360/180	0.200	1.000	53	10	0.50	1.10
	30	HFC 338	520/260	0.100	0.300	54	7	0.20	0.35
	30	HFC 330	520/260	0.100	0.300	52	7	0.19	0.34
	30	HFC 308	680/340	0.100	0.320	60	6	0.20	0.35
	20	H 5020	680/340	0.050	0.180	46	6	0.11	0.20
Medium Temperature Range	50	H 5033	550/275	0.200	3.500	55	7	0.450	0.900
	30	H 5006	550/275	0.100	0.350	51	7	0.240	0.460
	18	H 5009	520/260	0.100	0.280	38	2.2	0.19	0.315
	18	H 5015	750/375	0.050	0.200	54	4.5	0.12	0.21
	16	H 5022	700/350	0.030	0.120	60	8	0.07	0.120
Wide Temperature Range	30	HFC 354	740/370	0.100	0.400	56	6	0.21	0.45
	20	HFC 258	894/447	0.050	0.160	42	4.8	0.11	0.19
	16	HFC 158	800/400	0.030	0.120	52	7.5	0.073	0.13



Write Hitachi for full information and specifications.

Hitachi Sales Corporation: 333 N. Michigan Ave., Chicago, Ill. 60601, U.S.A. Tel: 726-4572/5  
Hitachi Düsseldorf Office: 4 Düsseldorf, Graf Adolf Strasse 37, West Germany Tel: 10846



# One - Oppped Again

A frequency compensated version of the incredible new LM101A, both monolithic, both an order of magnitude improvement over anything else on the market. Full military temperature range  $-55^{\circ}\text{C}$  to  $+125^{\circ}\text{C}$ , the LM107 is \$30.00 in hundred quantity and the commercial/industrial  $0-70^{\circ}\text{C}$  LM207 costs \$12.00 at one hundred pieces. For complete information contact National Semiconductor Corporation, 2975 San Ysidro Way, Santa Clara, California 95051 (408) 245-4320 TWX: 910-339-9240 Cables: NATSEMICON

## BEFORE THE LM107

### FET Operational Amplifier

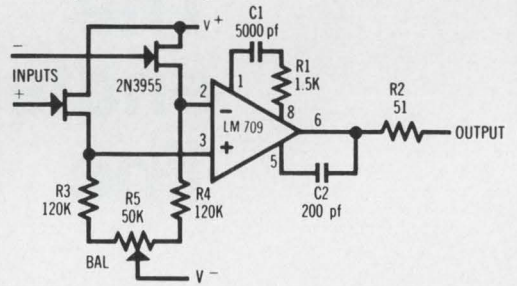

## NOW

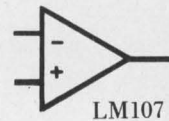

# National

# Linear



# The endless line

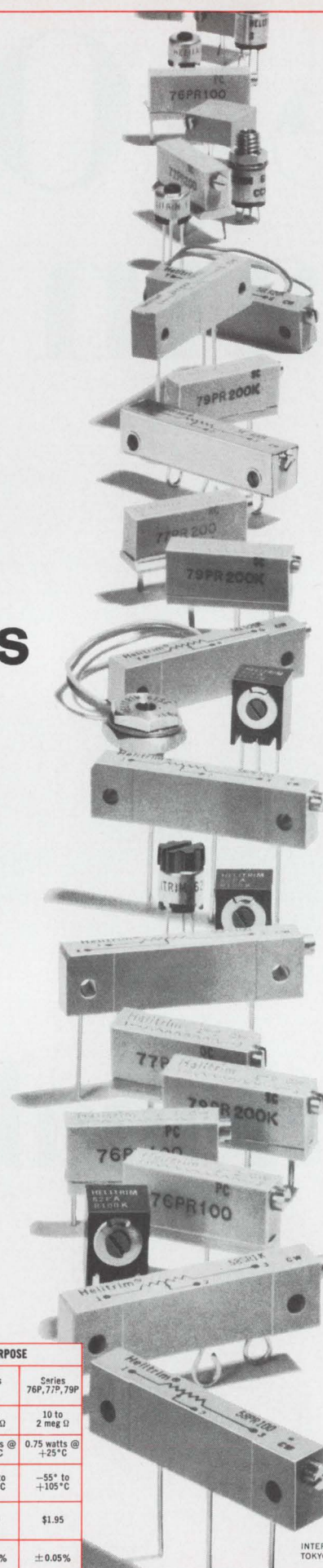

It's a complete line – an endless line of Helipot® cermet trimming potentiometers with a current field failure rate of only 0.08%.

And all have essentially infinite resolution. Plus a wide range of standard resistance values. And excellent setting and total resistance stability under a wide range of environmental extremes. Helipot stocks almost 2 million trimmers in a wide range of models and values at 13 stocking locations. All to fit your every need—whatever it is. To fit your budget—list prices from \$1.75. And to assure you immediate delivery—anywhere in the U.S. and in Canada.

For more details on “the endless line” of cermet trimmers, contact your local Helipot sales representative. He'll tell you all about cermet reliability, fill you in with all available test data and personally handle your Helipot orders.

	MILITARY		HIGH TEMP.		GENERAL PURPOSE		
	Series 55, 56, 58 (RJ11 & RJ12)	Series 61 (RJ50)	Series 63 (RJ24)	Series 50	Series 62	Series 78	Series 76P, 77P, 79P
Resistance Range	10 to 2 meg Ω	10 to 1 meg Ω	10 to 2 meg Ω	10 to 2 meg Ω	10 to 1 meg Ω	10 to 2 meg Ω	10 to 2 meg Ω
Power Rating	1 watt @ +85°C	0.5 watts @ +85°C	0.5 watts @ +85°C	1.5 watts @ +125°C	0.5 watts @ +70°C	0.75 watts @ +70°C	0.75 watts @ +25°C
Operating Temperature Range	-65° to +175°C	-65° to +150°C	-65° to +150°C	-65° to +200°C	-25° to +125°C	-25° to +125°C	-55° to +105°C
Price (List 1 to 9)	\$5.50	\$5.50 (61P) \$6.50 (all others)	\$6.50	\$8.00 (50) \$7.50 (53, 54)	\$1.75 (62P) \$2.00 (62PF) \$2.50 (all others)	\$3.00	\$1.95
Typical Setting Ability	±0.01%	±0.05%	±0.01%	±0.01%	±0.05%	±0.05%	±0.05%

**Beckman**

INSTRUMENTS, INC.  
HELIPOT DIVISION  
FULLERTON, CALIFORNIA • 92634

INTERNATIONAL SUBSIDIARIES: GENEVA; MUNICH; GLENROTHES, SCOTLAND; TOKYO; PARIS; CAPE TOWN; LONDON; MEXICO CITY; STOCKHOLM; VIENNA



# Technical Articles

---

**MOS memory arrays  
come on strong**  
page 54

P-channel metal oxide semiconductor circuits promise to become basic elements of main, read-only, and associative memories, as improved processing techniques and the use of larger semiconductor slices reduce costs, and increasing miniaturization boosts speed. Yields, too, are expected to improve with advances in processing equipment and the accumulation of experience in making the devices.

**FET converter  
is self-oscillating**  
page 62

Automatic gain-control circuitry can solve special problems associated with using a FET as both an oscillator and mixer in a commercial radio set. For one thing, it eliminates the unwanted square wave normally produced by limiting of the FET's forward-biased gate current. Thus, a FET circuit as simple as a bipolar circuit can give better noise performance and interference rejection.

**European market:  
It's got to be good**  
page 65



Electronics' editors and correspondents survey the outlook for the coming year in 11 countries. Their main finding: the surging West German economy ensures a good 1969 for business generally and for electronics particularly throughout Western Europe. The over-all rise in sight is 10.6%, and this will carry the electronics market past the \$7 billion mark—not counting components. Forecasts for France and Britain, though they point to good growth, have to be hedged. Britain's pound is still endangered by a nagging balance of payments deficit and the French franc is still under the threat of devaluation, despite de Gaulle's doughty approach to monetary matters.

**Annual forecast  
of U.S. markets**

## Coming

How prospects shape up in a baker's dozen outlets during 1969, with statistical material and sales estimates for hundreds of product categories.



# MOS arrays come on strong



With their low power dissipation, the circuits can be densely packed on a chip; they promise to find a place in main storages and in read-only and associative memories, too, yielding to bipolars only when speed is essential

By William F. Jordan

Computer Control Division, Honeywell Inc., Framingham, Mass.

**The Establishment** has been taking its lumps lately in every field—including computer memories. Like the authority of political leaders, university presidents, and movie censors, the reign of ferrite cores is being challenged from several directions. And perhaps the most serious challenger is a ceramic plane containing a hybrid assembly of p-channel metal oxide semiconductor chips and bipolar sense and drive chips.

Much of the work in this area, and with all-bipolar arrays as well, has so far been limited to scratchpad memories. But commercial systems holding tens of thousands of bits are already in production—for the IBM 360/80 computer, for example, which has a bipolar semiconductor buffer memory between its main storage and processor.

And the trend may lead to the evolution of computer architectures employing several random-access, read-write memories with more specialized functions—an evolution possible only through the use of semiconductor memories. Because all memories are composed of many identical elements, and because they function in an essentially orderly and repetitious manner, they stand to benefit more from microelectronic packaging developments than would any other part of the computer.

MOS technology is also applicable to the fast-growing area of read-only memories. And the heretofore slow development of content-addressable memories may be speeded by the large-scale integration of MOS circuits.

As main memories, p-channel MOS circuits are attractive for their ease of fabrication, low power dissipation, relatively high yield, and high density.

These circuits can be processed in 25 steps, compared to about 150 for bipolar circuits and 50 for complementary MOS circuits, which use both p- and n-channel devices. And because the MOS transistor is controlled by an insulated gate, it dissipates

practically no power through its gate electrode, and none at all when it's not switching.

## Up tight

As for density, MOS circuits—unlike bipolars—can be closely packed on a chip without danger of interaction or overheating because of their low power dissipation and because they don't need the isolation regions required by the bipolar circuits. All the action in MOS technology occurs between, rather than around, two deposited areas—source and drain—so there's no need for a wall of oppositely doped material to isolate collector leads from spurious signals produced by adjacent transistors. In bipolar circuits, this wall takes up space with its own volume and that of the biasing leads.

## Read-only memory applications

### Function tables

- Character conversion
- Logarithmic tables
- Trigonometric tables
- Memory location tables
- Transducer calibration

### Emulation

- Of software for competing computers
- Of software for older computers

### Microprogramming

- To minimize single-purpose control logic
- To permit specialized instructions
- To streamline changes as designs evolve
- To reduce costs of initializing and fault diagnosis

### Input/Output

- To adapt different devices to a standard computer interface



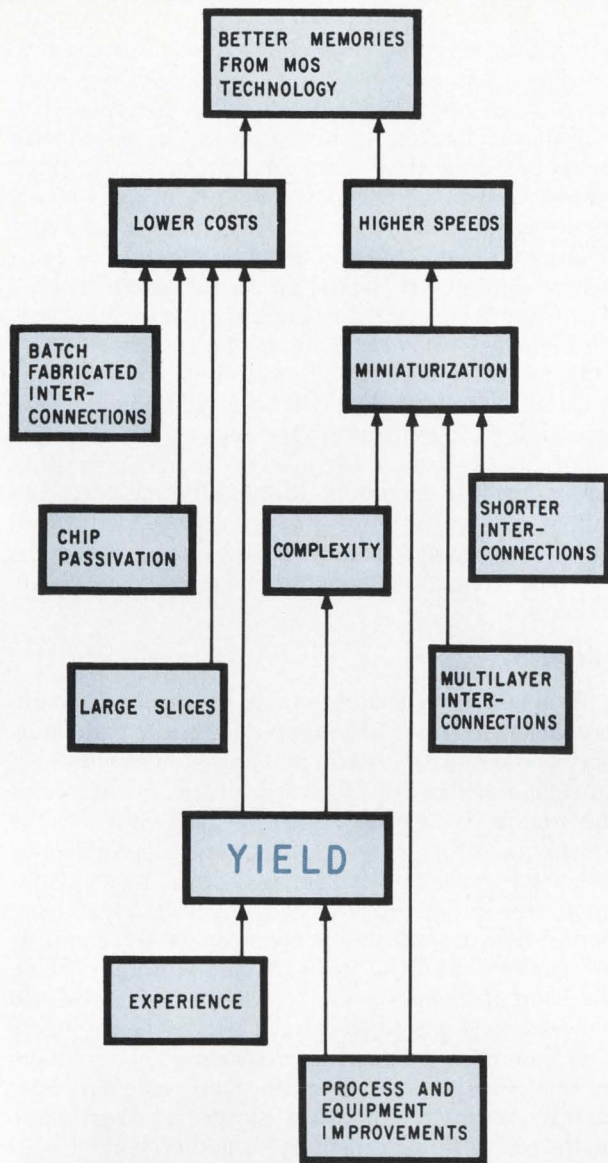

**Common factor.** Yield is a major influence on both the cost and speed of MOS memories.

And the relatively high cost of bipolar chip “real estate”—silicon surface area—is aggravated by the fact that the accumulative yield isn’t as high with these circuits as with MOS.

Present p-channel MOS memories also have several advantages over magnetic memories, as summarized in the table, page 56. For one thing, they are capable of much higher speeds. For another, their peripheral circuitry can be much simpler because they don’t need such closely controlled drive currents and because their sense signals are more easily discriminated and are accompanied by less noise. And although semiconductors in general are highly sensitive to temperature variations, MOS memory circuits can be designed to operate under worst-case conditions at the extremes of a suitable temperature range. Magnetic memories, on the other hand, require currents of a specific magnitude at any temperature and therefore need power

supplies whose current outputs vary as temperature varies over the design range.

### Coming attractions

There’ll be several developments in the near future that will make MOS circuits more attractive in many memory applications, developments chiefly involving cost and speed, as shown at the left.

- Lower costs, for instance, will accrue from the automating of face-bonded interconnections, from the development of new techniques for chip passivation—putting down the hermetic layer on top of the chip—and from the use of larger slices of substrate. The traditional 1-inch and 1¼-inch slices have already been replaced by 2-inch slices at many plants.

- Higher speeds will be possible with miniaturized circuits and devices. The interconnections will be shorter and multilayered, and thus will have less capacitance—the factor limiting speed. Process and equipment improvements should lead to greater degree of miniaturization.

- Yield, that old bugaboo of solid state devices, directly influences both cost and—through greater complexity of integration—the degree of miniaturization. Improvement in this area depend again on process and equipment improvements, plus just plain experience.

### Isolated storage

The concept of the read-only memory goes back many years—farther than the electronic computer itself. With the advent of integrated bipolar and MOS arrays, the concept has matured.

Any read-only memory has two basic functions: bit storage and bit isolation. The storage in bipolar arrays is provided by array interconnection in one of the final process steps. In MOS arrays, an oxide pattern is generally used to establish the data. A thin oxide layer over the channel area of a MOS transistor separates the channel from the gate electrode; if the layer is thick, the gate won’t work. Thus, stored 1’s and 0’s in the read-only memory are established by thin and thick regions in the oxide. Oxide thicknesses, in turn, are determined by the mask used at the appropriate process step.

However, another storage scheme involving gate connections has been proposed. In this process, certain connections are made by very narrow metal patterns, which melt when heavy currents are passed through them. Under program control, such currents can be made to establish the pattern of stored data.

This process is likely to be rather expensive, though, because the fuse-links must have both close tolerances and direct access for fusing through external connections. And this means that decoders and sense amplifiers cannot be integrated with the storage array.

Isolation in this context means that bits must be individually addressable, with no false outputs caused by “sneak paths” from other bit positions. It does not refer to the kind of isolation mentioned



## Memory characteristics

	Ferrite cores	Plated wire	PMOS
Cell spacing	25 x 25 mils	50 x 50 mils	2 x 4 mils
Sense signal	50 mv	15 mv	100 mv
Word current	400 ma	600 ma	100 ma*
Word voltage	25 v	25 v	20 v
Cycle time**	600 nsec	450 nsec	300 nsec
Access time	320 nsec	250 nsec	300 nsec

\* For capacitance charging  
\*\* 250,000 bit system

earlier—the separation of transistors on a single substrate by a wall of material between them. Bit isolation is often achieved with diode arrays, because a diode conducts current in only one direction and therefore cannot be part of a sneak path. But in bipolar technology, transistors aren't significantly more expensive than diodes, and employing them for sneak-path isolation makes their gain available to increase speed.

The need for read-only memories is clearly growing, as indicated in the table on page 54. For the peripheral function tables, p-channel MOS is fast enough and its low cost makes it attractive. For computer microprograms, cycle time must be a small fraction of the computer's main-memory cycle time, so bipolar arrays, with their higher speeds, get the nod.

### By content

The concept of content-addressable storage also goes back several years—12, to be exact—but this type of memory isn't yet in wide use. A content-addressable, or associative, memory, is one from which data is fetched in terms of its content rather than its location.

Alone among memory forms, the associative requires both storage and logic in its arrays—storage to “remember” the data and logic to compare stored data with input keys that identify it. Because of this, it was assumed for a long time that these memories would have to be cryogenic; no other technology seemed feasible. To be sure, a few investigations were carried out with magnetics and even with transistor circuits. But the projected 1972 cost with either of these technologies was somewhere between \$1 and \$10 per bit—expensive even for small memories.

But large-scale integration should make a content-addressable memory feasible at a cost as small as 1 to 20 cents a bit by 1972. Furthermore, because of its requirement for fault-tolerant structures, LSI provides the need as well as the means for such a memory. A defect in one word of a large monolithic array wouldn't be cause for rejecting the entire array if it could store data associatively; it would simply reduce the capacity by one word.

Even so, a cryogenic memory may turn out to be the best form of large-scale content-addressable file storage because it's relatively nonvolatile. Unless they're backed up by batteries, semiconductor memories lose their data almost instantly when primary power fails. A power failure in a cryogenic memory, shutting down its refrigerator, would also destroy the data—but the array would take at least several minutes to warm up to the danger point. The high fixed cost of refrigeration would be prohibitive for smaller memories, however.

Quite possibly one of the first commercially successful LSI products will be a medium-size content-addressable memory for use as an auxiliary input-data processor for a conventional computer. At least one MOS content-addressable memory containing 128 words of 48 bits each has already been built, and bipolar memories now locate programs in large commercial computers' segmented main memories.

### Hierarchy

A small content-addressable push-down memory, installed between a computer and its main storage, would make the main memory appear very fast. In such a memory, every word written is entered at the top, and the word that has been unused the longest is at the bottom, disappearing permanently when the memory “overflows.” Since most cycles fetch words that have already been used at least once, such a push-down memory would serve as a “window” into the main memory through which the computer can see the words it's most likely to need—namely, those that have been recently used.

Rather than a straight shift of old words down as new words came in at the top, efficiency demands an external address counter to keep track of the words in the memory, together with a content-addressable capability for fetching data. To be of greatest value to a system, the memory would have to operate at high speed, and therefore should be built of bipolar circuits.

In addition, bipolar scratchpad memories and p-channel MOS serial memories should become quite common. And their progeny will appear in strange new computer architectures and exotic packaging. But one thing is absolutely clear—the enormous investment in LSI will stimulate higher-speed and lower-cost memory technologies.

### Bibliography

A.E. Slade and H.O. McMahon, “A Cryotron Catalog Memory System,” National Joint Computer Committee, Conf. Proc., Vol. 10 (Eastern Joint Computer Conference), 1956, p. 115.  
Alan Corneretto, “Associative Memories, a Many-Pronged Design Effort,” *Electronic Design*, Feb. 1, 1963, p. 40.

This article is another in Electronics' continuing series on memory technology. Previous articles appearing in the Oct. 28 and Nov. 11 issues.



# Designer's casebook

## Voltage regulator built from two AND gates

By Mike English

Fairchild Semiconductor, Mountain View, Calif.

**Most engineers** consider AND gates useful only for logic functions in digital computers. But with a little imagination a resistor-transistor, two-input, dual AND gate can be made into a power supply switching regulator or into many other devices.

The regulator consists of two RTL AND gates— one used as a differential amplifier and the other

as an astable multivibrator. The differential amplifier (shown in blue) works as an error detector by sensing the difference between a reference voltage set by the voltage divider,  $R_1$  and  $R_2$ , and the output voltage tapped by  $R_4$ . The amplifier then produces an error current from  $Q_1$  that changes the duty cycle of the astable multivibrator (shown in red) and the series switch  $Q_3$ . The waveform, with a variable duty cycle, is integrated by the inductor and the 200-microfarad capacitor, producing a varying d-c output level that reaches a null when the voltage on the wiper of  $R_4$  equals the voltage set by  $R_1$  and  $R_2$ .

Output ripple is less than 20 millivolts peak-to-peak. At an output of 10 volts, load regulation from no load to 1 ampere is 0.2%.

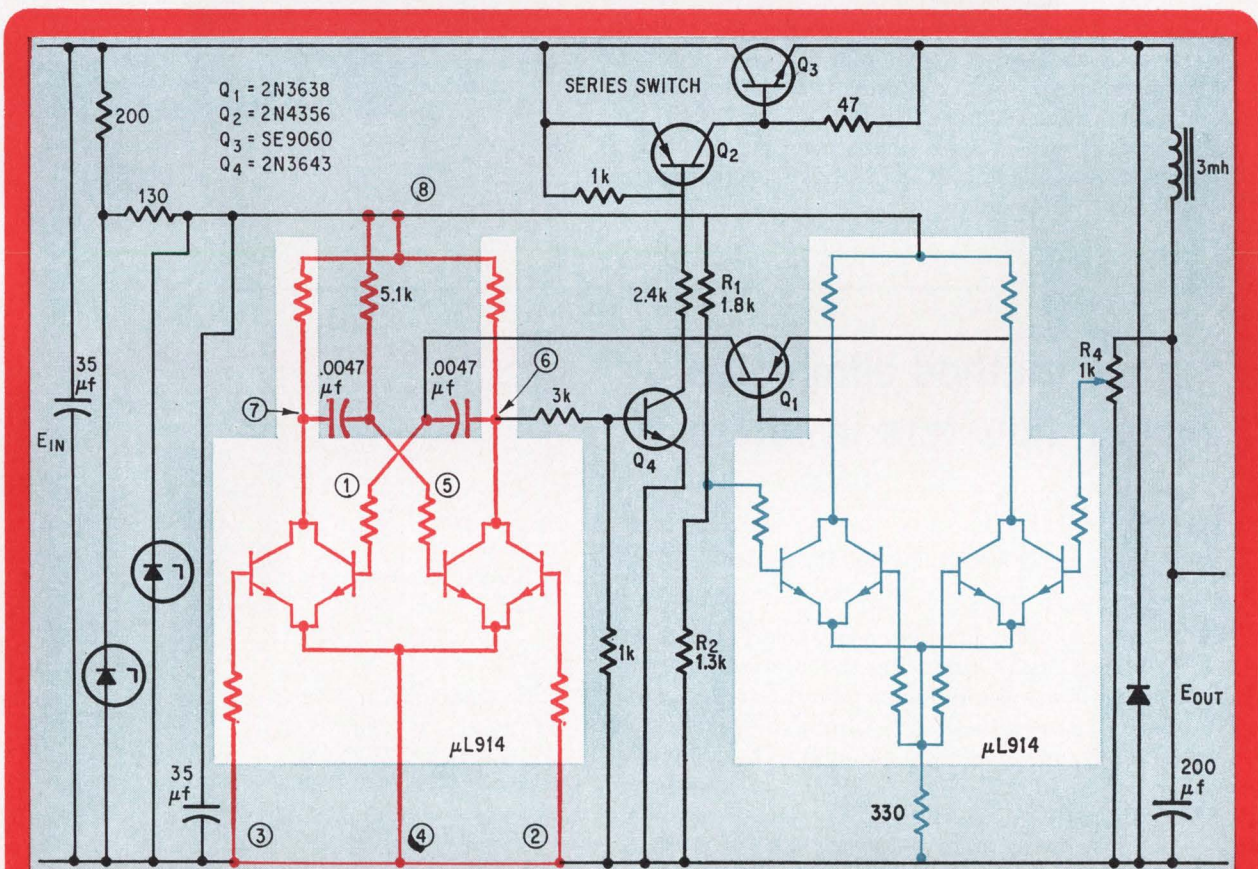

**Versatility.** With a few extra components, the uL 914 two-input dual AND gate can be converted into a differential amplifier and an astable multivibrator. Connecting the two makes a voltage regulator. The amplifier acts as an error detector, changing the duty cycle of the multivibrator.



## High-precision preamp built from 3 transistors

By T.C. Penn

Texas Instruments Incorporated, Dallas, Texas

**High gain-bandwidth products** at low noise and low frequency are difficult to achieve. But the difficulty can be lessened by using field effect transistors with a noise level of 20 nanovolts per square-root cycle at 10 hertz. A 20-decibel negative feedback stabilizes the gain at 1,000 within 3 db from 0.5 hz to 300 kilohertz, with low distortion. The intermediate frequency transition point in the noise spectrum occurs at 300 hz.

The inner d-c feedback loop places the FET at a high transconductance point.

The npn stage works as: a d-c voltage regulator to control the operating point of both the FET and the output stages; a low-impedance driver for the output stage, and an a-c current regulator to provide a high-drain load impedance without the need for a high-voltage supply.

As the input voltage increases, the FET's drain current increases proportionately.  $Q_1$ 's base is driven negative and its emitter tries to maintain a constant voltage across the 2.2-kilohm drain resistor. This drives  $Q_2$ 's base negative through a low a-c impedance, and a positive output voltage appears at its collector.

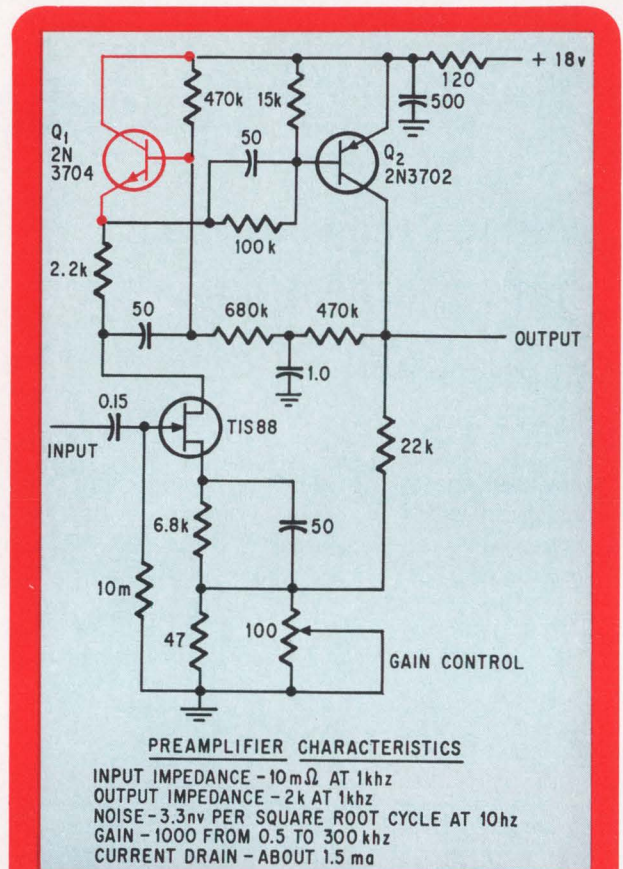

**Quieter.** The FET's low noise allows greater feedback, improving stability and reducing distortion. The npn stage controls the FET.

## Simple method eliminates excess inductors in filters

By Harold R. Hall

Naval Undersea Warfare Center, San Diego, Calif.

**Inductors** in audio LC filters are large, expensive, unstable, and lossy. Reducing the number of inductors in bandpass filters has required lengthy calculations, but a new method is simple and overcomes the difficulty of a negative inductor. The technique can be used in any network that contains one or more inductive T's. Each three-inductor T is replaced by two similar inductors, one of which is tapped to form an autotransformer.

This equivalence has been used only rarely in filter networks, because one of the inductors in the T ( $L_c$ ) is negative and because the transformer

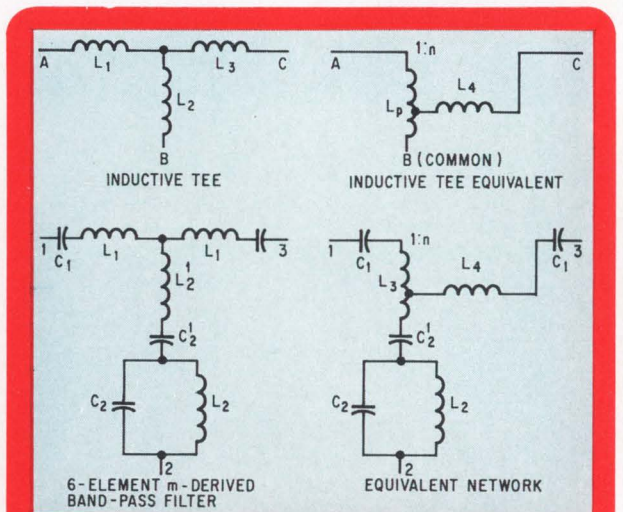

**Tapped T.** An autotransformer can replace an inductor in filters containing a T. The filter is smaller and easier to calculate.



must be lossless and have a coupling coefficient of unity. However, high-Q toroidal inductors of the type commonly used at audio frequencies have both low losses and a coupling coefficient near unity. An inductor of this type, tapped to serve as an autotransformer, will approximate the requirements of the transformer in the first diagram.

The T has been replaced by an autotransformer  $L_1$ , and a positive inductor  $L_4$ . The autotransformer replaces  $L_1$  and  $L_2$ ;  $L_4$  is made sufficiently greater than  $L_3$  to offset the equivalent negative inductance at its tap. The following equations yield  $L_p$  and  $L_4$  in terms of the original T.

$$L_p = L_1 + L_2 > 0; \quad L_4 = L_3 + \frac{L_1 L_2}{L_1 + L_2} > 0$$

$$n = \frac{L_2}{L_1 + L_2} < 1$$

where  $n$  is the turns ratio of the autotransformer.

This method works for  $m$ -derived series bandpass filters,  $m$ -derived low-pass image parameter filters, and elliptic-function series bandpass filters. For example, the network equivalent for a six-element,  $m$ -derived bandpass filter can be described by the following set of equations:

$$L_3 = \left( \frac{1 + m^2}{2m} \right) L_K; \quad L_K = \frac{R}{\omega_c}$$

$$L_4 = \left( \frac{2m}{1 + m^2} \right) L_K; \quad n = \frac{1 - m^2}{1 + m^2} < 1,$$

and  $\omega_c = 2\pi(f_2 - f_1)$ .  $R$  is the design load resistance of the filter and  $f_2$  and  $f_1$  are the cutoff frequencies. The value of  $m$  is obtained from  $L_1 = mL_K$ .

## Two IC comparators improve threshold converter

By George S. Oshiro

Teledyne Systems, Los Angeles, Calif.

**Converting** sine waves to symmetrical square waves would seem an easy task. But it isn't if the circuit

has to operate in noise under wide temperature and amplitude variations. Two comparators operating in complementary fashion preserve the output's symmetry during large input changes and mil-spec temperature ranges.

The comparators' outputs trigger the R-S flip-flop on their leading edges. The positive offset from one comparator is added to the negative offset of the other thus maintaining symmetry. The comparators' matched qualities eliminate offset effects from temperature swings.

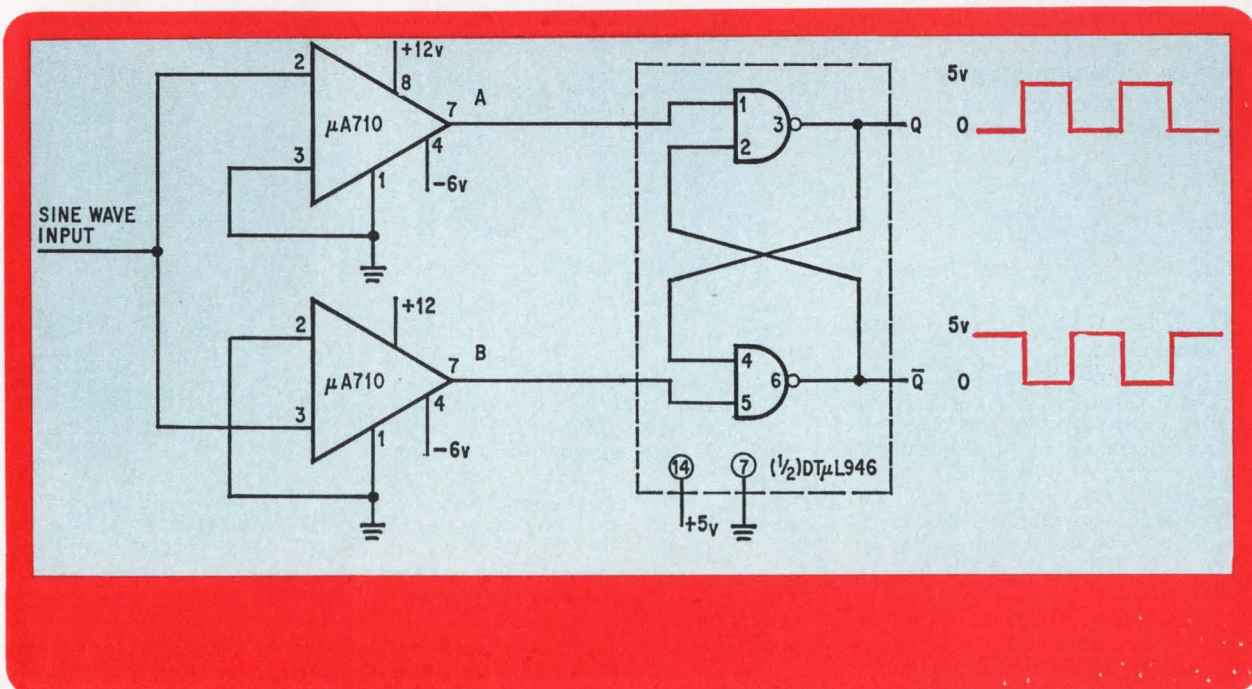



# RCA Solid-State Data for Designers

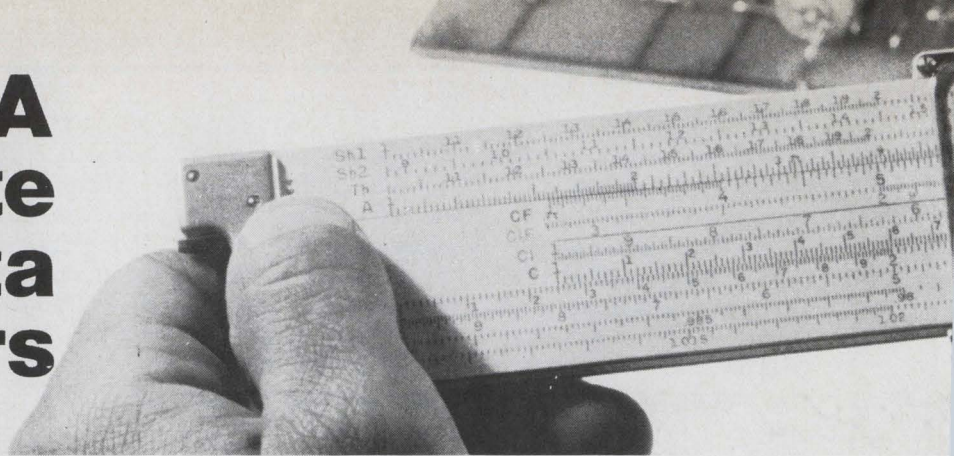

## Build Stability and Long Life into Control Designs

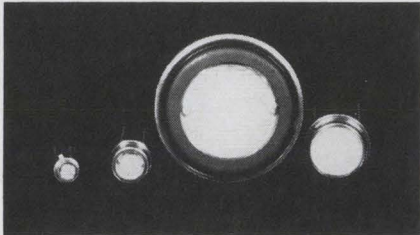

RCA has a selection of photocells that's one of the industry's widest... including cadmium-sulfide devices (with a maximum response of 5100 Å) and cadmium sulfo-selenide units (with maximum response of 6150 Å).

They're extensively used in a range of industrial applications such as counting, position and level indicators, pilot-flame monitoring, automatic lighting controls, burglar and other alarm systems. There's a comprehensive booklet—containing full information on RCA's line of photocells, and representative circuit schematics—plus technical data.

Circle Reader Service No. 153.

## Turn On or Turn Up—High Speed Switching and Amplifier Applications in New Equipment Designs



Here are two new epitaxial silicon n-p-n transistors ready for your design evaluation. Both have high current and high power handling capacity plus fast switching speed, and are especially suited for use in switching-control amplifiers; power gates; switching regulators; converters; inverters and control circuits of many kinds. Use them, too, as DC-RF amplifiers and as power oscillators.

The units are RCA developmental types TA7323 and TA7323A—both mounted in JEDEC TO-3 package. The "A" version has higher voltage ratings [ $V_{CEO}$  (sus) of 120 V maximum compared with  $V_{CEO}$  (sus)=90 max.]

and lower leakage currents—making your selection of units for evaluation relatively simple. Both have turn-on times of 0.5  $\mu$ s maximum at 15 A  $I_C$ .

So if your designs can use such epitaxial silicon n-p-n devices to turn things on—or turn them up—circle Reader Service No. 154 for full details on these two transistors.

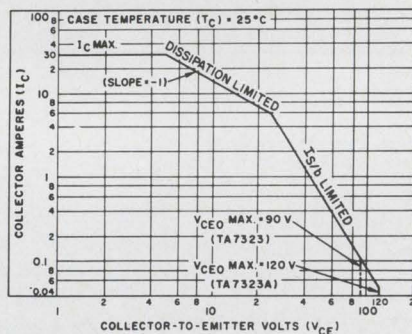

## Pick Your Applications For This IC "Building Block"

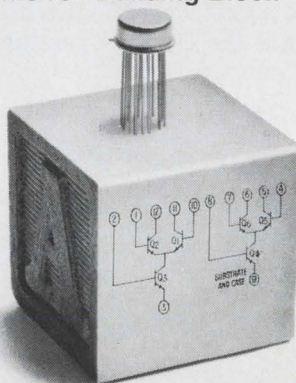

RCA-CA3026 is a true "building block" for all sorts of uses! Two matched differential-amplifier pairs on a single substrate offer uncommitted bases and collectors for broad input and output accessibility...and flexibility...for applications from dc to 120 MHz. Try it for dual Schmitt triggers; dual sense amplifiers; differential and/or cascode amplifiers; IF amplifiers; limiters; video amplifiers; doubly-balanced modulators and demodulators—just for a start!

RCA-CA3026 brings the advantages of monolithic IC devices to the most comprehensive range of solid-state circuit applications yet.

Circle Reader Service No. 155 for full details.

## Keep Your Cool in Handling High-Power Control Problems

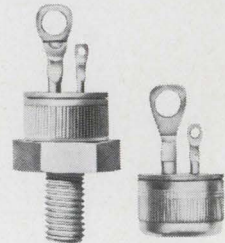

How's this for power-handling capability: 300-ampere peak surge (non-repetitive) on state current rating... 5 kW for 120 V line operation or 10 kW for 240 V? No point in getting heated up over control problems in such areas as furnace controls; arc welding controls; heater unit controls; motor controls; photocopying equipment controls; lighting controls; oven controls, and anywhere else you want to replace back-to-back SCR's with a single press-fit or stud type triac.

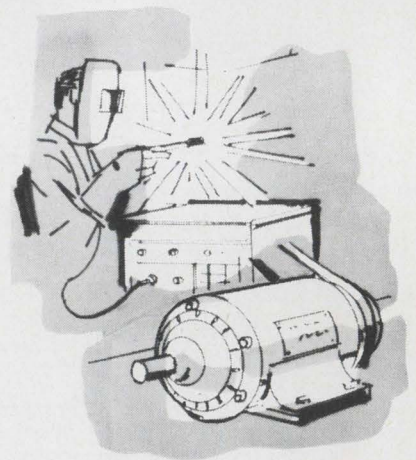

RCA-2N5441 and 2N5442 press-fit, as well as 2N5444 and 2N5445 stud-type triacs can replace virtually any two SCR's in circuits with voltage and current requirements comparable to those requirements for the 2N690 or 2N3899 SCR applications... and do the job with fewer components.

Circle Reader Service No. 156 for full details.



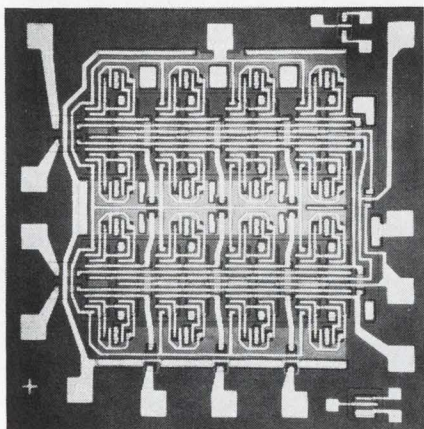
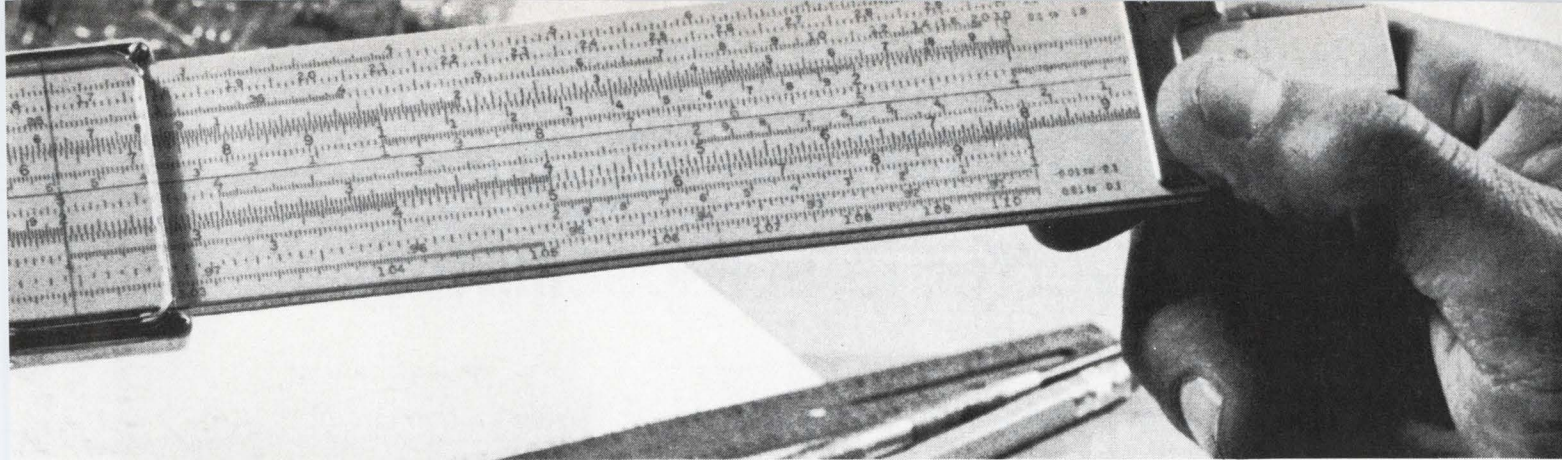

### COS/MOS – RCA Breakthrough In Logic and Memory IC's

RCA COS/MOS – Complementary Symmetry MOS Integrated Circuits – now open the way to compact, ultra-low-power digital systems. RCA technology produces complementary pairs of "N" and "P" channel MOS transistors on the same substrate in high density circuit configurations that offer unique performance characteristics.

With COS/MOS, you can design for a 10-volt logic swing with a single 10-volt power supply, 4-volt noise immunity, fanouts up to 50, -55°C to +125°C operation and nanowatt quiescent dissipation. You get megacycle switching speeds, single phase clocks and freedom from tight tolerance power supplies.

COS/MOS is available to you in a growing range of circuits—from gates and flip-flops to MSI logic and memory. For technical data, circle Reader Service No. 157.

### Here's General-Purpose Power for Small-Signal Applications

RCA types 2N5320 and 2N5321 are triple-diffused silicon n-p-n planar type transistors—differing only in voltage ratings, leakage current and beta-spread values. They have all the well-known desirable features of the 2N2102 type—and higher collector-current and dissipation ratings.

Use these units for medium-power small-signal applications in your mil-



itary, industrial and commercial equipment... wherever the design requires devices with low noise and low leakage characteristics, low saturation voltage, high beta, and fast switching speeds.

For detailed specifications data and complete characteristics, circle Reader Service No. 158.

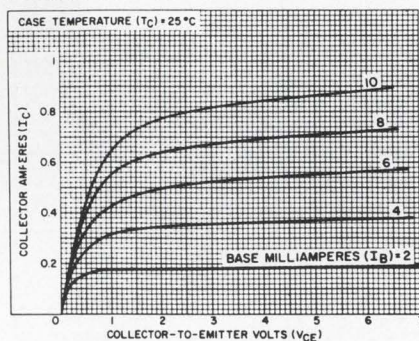

### No Signaling and Detection Problem Too Tough for These GaAs Laser Diodes And IR Emitting Diodes

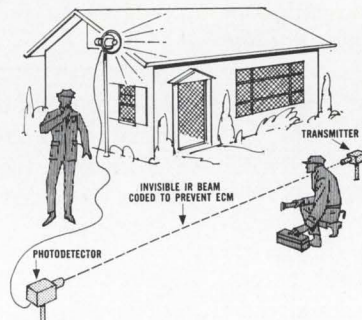

Need "light" beams invisible to the human eye for law enforcement, industrial safety, and military security applications? RCA optical devices can do the job. For your applications in communications, ranging, security systems, and fuse designs, RCA offers TA2930, TA2628, and 40598.

Developmental type TA2930 is a laser diode array capable of providing 50 W minimum peak output power at 30 A peak pulse forward current. TA2628, a single laser diode, can provide 1 W minimum peak output power at 30 A peak pulse forward current. 40598, an IR emitter, is rated at 0.3 milliwatt minimum radiant power output at 50 mA. For comprehensive technical data sheets, circle Reader Service No. 159.

### High Beta Values, High Dissipation Ratings, High Voltage Capabilities...

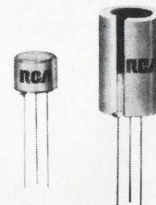

The characteristics you need for high-voltage, high-current amplifier and high-current switching applications are provided by RCA's 2N3241A family of silicon n-p-n, epitaxial, planar transistors. Fourteen types give you a broad selection of ratings and characteristics for audio pre-amplifier, audio and video amplifier, computer switching and instrumentation circuits. Included in the family are transistors with integral heat-radiators which provide 50% lower thermal resistance between junction and ambient and thus twice the dissipation capability of the prototypes at ambient temperatures up to 25°C.

Take advantage of these ratings for your circuit designs:

**AUDIO PREAMPLIFIER**—NF as low as 2 dB at 10 kHz, beta values as high as 165 min. at  $I_C = 10$  mA.

**AUDIO AMPLIFIER**— $P_T$  ratings as high as 2 W at  $T_C$  to 75°C for types with heat radiators, high current capabilities to 300 mA max.

**HIGH-CURRENT SWITCHING** applications including nixie and core drivers up to 300 mA max.

**INSTRUMENTATION**—high beta values; leakages as low as 10 nA max. at  $V_{CB} = 25$  V; saturation voltages as low as 0.1 V typ., 0.2 V max. at  $I_C = 100$  mA; breakdown voltages to 40 V.

Circle Reader Service No. 160 for detail specs.

See your RCA Representative for full information on all products shown. Ask your RCA Distributor for his price and delivery. Or write for data sheets to RCA Electronic Components, Commercial Engineering, Section No. QN-12-2, Harrison, N. J. 07029.





# FET converter is self-oscillating

The problem of square-wave drain current has been solved by an agc circuit that keeps the local oscillator voltage level constant, without clipping

By Daniel R. von Recklinghausen

H.H. Scott Inc., Maynard, Mass.

Although most top-of-the-line f-m stereo receivers feature field effect transistor front ends, less sophisticated sets generally use the less costly bipolar-transistor converters. These converters generally give poor noise performance and tend to produce excessive odd-order cross-modulation products that cause interference from neighboring stations.

However, a self-oscillating FET converter can be produced more cheaply than the popular bipolar autodyne type yet perform as well as externally excited FET mixers. Self-oscillating FET converters have been difficult to design because of the limiting action of the FET's forward-biased gate current, which produces an undesired square-wave signal. This problem can be solved by automatic gain-control circuitry, which maintains the oscillator voltage at a constant level without clipping.

## Better than bipolars

The converter must be able to operate under strong signal conditions without overloading and to provide the required gain for low-level signals. It should be free from spurious responses, have a low noise figure because of signal power losses, and provide good isolation between its input and output terminals. Ideally, it should have a square-law characteristic; that is, only the sum and difference signals of the incoming r-f and the local oscillator should be produced.

Compared to bipolar transistors and diodes, whose basic transfer curves are exponential, FET's make better mixers or converters because of their low-noise performance and good transfer characteristic. And FET converters can accept signal levels at least 20 decibels higher without spurious responses. In the past, however, only bipolar transistors could be designed into the simpler self-oscillating circuits. FET's could not be used in these circuits because of the need to closely control the level of the oscillation signal injected into the converter. Every attempt at such control re-

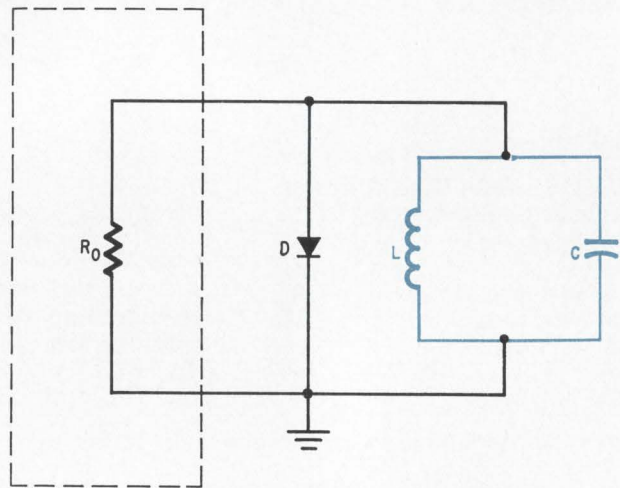

**Level.** The diode, across the oscillator's negative resistance and resonant circuit, sets the voltage to the FET converter. Higher voltages could be used if more diodes, connected in series, were added.

sulted in a square-wave drain current because of limiting by cutoff and saturation.

An agc circuitry not only solves this problem but also reduces tuning capacitance and simplifies a-m loop antenna design.

Consider the basic parallel resonant circuit shown above. The oscillation waveform remains sinusoidal only as long as the impedance of the circuit, tuned to the harmonics of the oscillator frequency, remains low in relation to the minimum resistance presented by the diode during positive signal peaks. Otherwise, the wave is clipped.

During oscillation, the average dynamic resistance of the diode is initially high but decreases steadily as the oscillation voltage increases. This voltage levels off as the dynamic resistance of the diode equals the negative resistance of the gen-



erator. This is shown graphically by point p in the curve, right. At this point the peak-to-peak oscillator voltage is approximately equal to the typical forward voltage of the diode.

For a germanium diode, the peak-to-peak voltage is 0.5 volt; for a silicon diode, it's 1.4 volts. Thus, the oscillator voltage is effectively clamped at a constant level, and even a 10-to-1 change in the generator impedance cannot change its level by more than 120 to 180 millivolts, peak-to-peak.

It thus can be seen that the transconductance of a converter is proportional to the applied oscillator voltage amplitude. Another circuit variation used to regulate the oscillator voltage involves putting a diode in series with the d-c voltage. If the d-c voltage, in turn, is further controlled by an agc circuit, the gain of the converter itself will be, for all practical purposes, automatically controlled.

In this arrangement, the FET amplifier providing the necessary gain to sustain oscillation will always be in conduction, ensuring constant limiting of the oscillator voltage. Thus, the converter will operate within the square-law region with a minimum of spurious responses. It is this ability to externally limit the amplitude of the oscillator voltage that allows the FET converter to operate to its fullest advantage. And the high gate-to-source impedance of the FET gives it good noise performance.

### No secondary winding

In the self-oscillating converter shown below, the FET's gate is a-c grounded, so there shouldn't be any oscillator voltage at its input. However, because of the high impedance circuit at the input, a small amount of oscillator voltage does appear at the gate through the FET's interelectrode capacitance. This voltage, which would mar the converter's performance, is removed from the circuit by

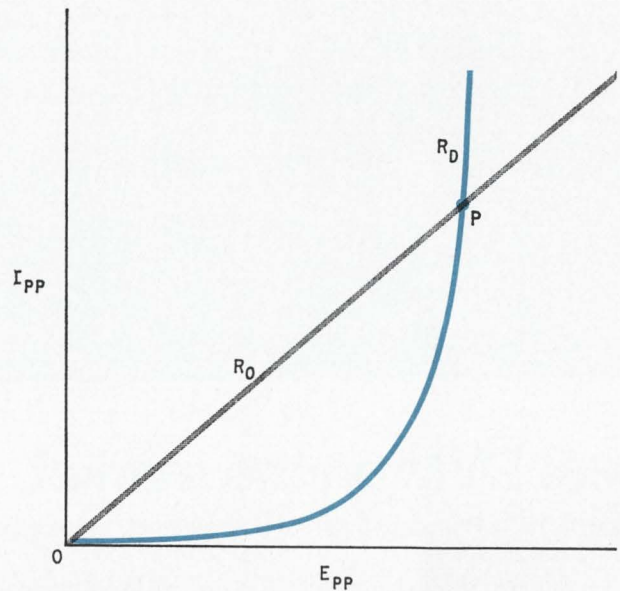

**Making a point.** P represents the oscillator's output level, the straight line the amplifier's output resistance, and the curve the diode's resistance.

the application of an out-of-phase oscillator voltage to the gate through neutralizing capacitor  $C_1$ .

The antenna and tuning capacitor are connected directly to the gate. If the circuit were designed with a bipolar transistor, the antenna would require a separate low-impedance secondary winding to match the device's impedance. Elimination of this secondary winding and the normal bias network substantially simplifies the circuit.

The circuit provides more overload capability and a lower noise figure than most transistor a-m receiver front ends using separately excited mixers.

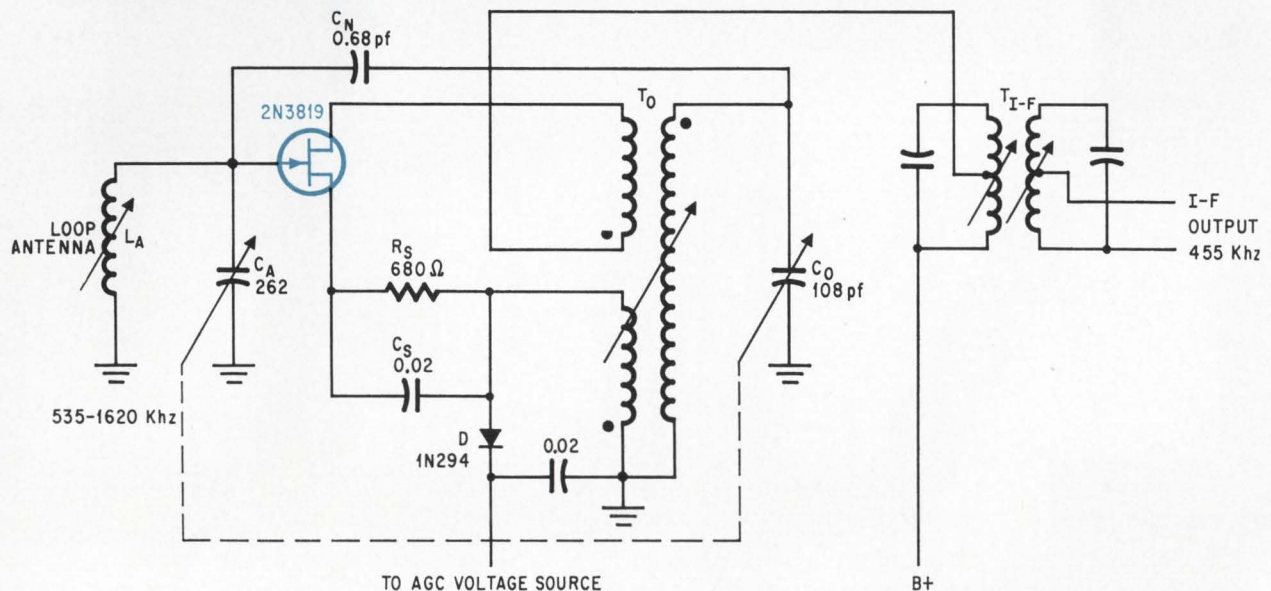

**Example.** A FET a-m converter circuit used in a commercial line of compact a-m/f-m radio-phonographs. The agc voltage source is the first i-f amplifier transistor (not shown).



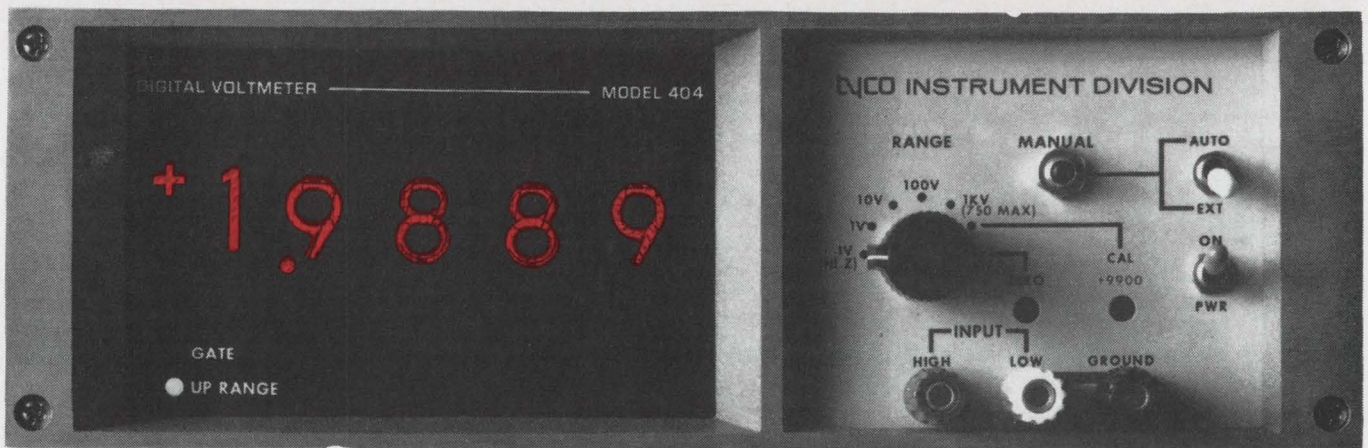

## Best DVM on the market. For all practical purposes.

It's the simplest way to measure DC levels . . . visually and with BCD outputs. The 404 is an extremely accurate DVM at a very reasonable price. It's portable. Easy to operate. Has four full digits with a fifth overrange. Accuracy of  $0.02\% \pm$  one digit. The 404 offers input flexibility

of five voltage ranges with an ultra-high input of 1,000 megohms on 1-volt range. And high noise rejection with differential input and integration techniques providing common mode rejection greater than 100 db at 60 Hz. It has BCD outputs and remote programming for system compatibility. And it costs only \$595. That's a lot of DVM for a relatively small investment. Call or write us for a

demonstration today. We'll have a 404 operating in your lab tomorrow. Practically. Tyco Instruments Division, Tyco Laboratories, Inc., Hickory Drive, Waltham, Mass. 02154, (617) 891-4700.

**For \$595,  
this can lead to  
almost anything.**

# tyco





# Electronics surveys European markets for 1969...

...and finds West Germany setting a pace  
that should carry sales in Western Europe  
up a solid 10% next year



Sweden		Switzerland		United Kingdom		West Germany		TOTAL	
1968	1969	1968	1969	1968	1969	1968	1969	1968	1969
5.1	5.5	7.4	7.4	31.2	31.7	35.0	37.8	146.0	153.6
6.4	6.5	12.8	13.8	45.5	45.0	115.0	115.0	315.7	313.3
3.4	3.7	3.3	3.8	18.5	23.8	39.5	44.0	103.8	121.9
25.3	28.1	21.0	20.8	149.0	141.0	215.0	213.0	961.0	944.4
17.6	19.2	4.2	8.4	51.0	68.0	110.0	145.0	223.1	319.6
3.2	3.4	5.5	5.8	20.0	21.0	25.0	27.5	91.2	98.0
61.0	66.4	54.2	60.0	315.2	330.5	539.5	582.3	1,840.8	1,940.8
1.4	1.4	1.1	1.2	4.6	5.0	10.5	11.5	25.5	27.6
0.2	0.2	0.1	0.2	1.4	1.4	4.3	4.5	8.5	9.2
1.3	1.5	0.5	0.6	2.1	2.1	3.4	3.8	12.3	14.5
1.3	1.5	1.0	1.1	4.5	4.6	6.2	6.6	28.4	30.0
8.5	9.1	3.2	3.4	10.4	11.8	21.0	25.2	68.5	80.5
2.9	3.1	1.1	1.2	5.0	5.7	11.0	11.6	35.4	38.4
15.6	16.8	7.0	7.7	28.0	30.6	56.4	63.2	178.6	200.2
7.0	11.5	7.2	7.2	25.1	26.9	13.0	13.5	127.0	125.3
0.4	0.5	0.3	0.4	6.0	8.1	4.5	4.5	19.7	23.7
4.6	4.7	2.9	3.1	16.5	18.1	28.0	29.5	95.2	102.1
4.5	5.2	1.2	1.3	25.2	27.7	51.0	54.5	128.8	140.4
5.7	8.8	4.6	5.6	45.3	48.3	26.0	28.6	147.0	158.5
45.0	47.5	42.0	42.0	139.3	142.0	157.0	178.0	637.0	678.9
4.0	4.4	2.0	2.1	64.0	66.0	68.5	70.0	213.8	223.3
1.6	1.7	1.5	1.7	16.0	18.4	27.5	30.5	84.3	90.9
1.0	1.0	0.1	0.1	6.1	14.2	4.0	8.0	19.3	34.9
4.0	4.3	2.5	2.7	42.8	43.3	38.5	41.5	139.8	147.3
77.8	89.6	64.3	66.2	386.3	413.0	418.0	458.6	1,611.9	1,725.3
1.7	1.7	0.3	0.3	5.5	6.6	6.5	8.0	27.7	32.2
0.3	0.5	0.1	0.2	3.3	4.0	2.0	2.5	13.5	17.0
42.3	50.3	34.1	39.5	205.0	252.5	275.0	320.0	1,010.7	1,213.1
3.5	4.2	1.7	1.9	30.0	35.0	32.1	37.0	125.4	149.0
2.2	2.6	1.1	1.3	15.0	17.0	48.7	57.4	94.4	112.4
6.5	7.9	3.5	3.9	22.0	24.0	35.0	40.5	121.6	141.3
56.5	67.2	40.8	47.1	280.8	339.1	399.3	465.4	1,393.3	1,665.0
0.8	0.9	1.3	1.3	4.5	4.5	3.7	3.7	20.9	21.0
1.3	1.3	0.4	0.4	1.9	2.2	3.2	3.4	15.9	16.5
1.0	1.1	0.4	0.5	8.4	9.5	5.9	6.1	25.7	27.6
1.8	2.5	0.5	0.5	2.1	2.3	3.6	3.7	16.1	17.1
0.4	0.4	0.1	0.2	0.7	0.8	1.5	1.5	7.0	7.4
1.5	1.5	0.5	0.5	4.5	5.7	5.0	5.5	27.1	28.5
6.8	7.7	3.2	3.4	22.1	25.0	22.9	23.9	112.7	118.1
1.8	1.8	0.7	0.8	7.5	8.3	8.5	9.4	29.5	32.4
1.5	1.6	0.6	0.6	5.5	6.0	8.8	9.7	27.6	30.1
2.9	3.1	1.6	1.6	12.5	14.0	20.0	21.2	65.4	70.2
4.2	4.6	3.3	3.4	8.0	8.8	11.5	13.9	58.5	65.5
4.2	4.6	3.6	3.8	12.0	13.2	9.7	10.8	57.5	63.0
0.8	0.8	0.3	0.3	3.1	3.3	5.5	5.8	15.0	15.8
29.0	33.3	20.5	22.3	60.7	67.4	104.0	115.0	448.1	496.7
0.6	0.7	0.6	0.6	5.6	6.0	7.2	7.7	24.2	26.4
3.2	3.5	3.5	3.8	22.5	21.5	65.0	72.0	148.2	161.0
48.2	54.0	34.7	37.2	137.4	148.5	240.2	265.5	874.0	961.1
0.2	0.3	0.1	0.1	1.1	1.2	2.5	2.7	9.5	10.1
1.8	2.0	0.6	0.6	1.2	2.7	4.2	5.2	17.4	20.4
2.3	2.5	0.4	0.5	1.3	1.5	4.2	5.3	19.8	22.0
2.2	2.3	0.8	0.9	4.9	5.2	4.5	5.4	23.3	26.5
1.2	1.3	0.4	0.5	5.2	5.7	8.5	9.0	32.0	34.7
5.5	5.5	1.4	1.6	4.5	5.1	12.0	13.5	46.8	51.3
1.2	1.3	0.3	0.3	2.9	3.5	4.5	4.6	17.5	19.1
6.2	6.4	2.7	3.2	11.8	12.8	20.0	21.9	82.4	89.8
2.8	2.7	0.9	1.0	3.5	3.7	5.7	6.0	28.8	30.6
3.0	3.3	1.3	1.3	11.0	12.2	10.8	12.0	53.6	58.2
2.4	2.6	0.9	0.9	4.5	5.1	7.5	8.3	28.9	31.8
0.3	0.3	0.2	0.2	2.4	2.8	3.2	3.5	9.6	10.8
5.5	6.1	2.1	2.3	12.9	13.8	25.0	27.0	83.1	91.2
34.6	36.6	12.1	13.4	67.2	75.3	112.6	124.4	452.7	496.5
300.5	338.3	216.3	235.0	1,237.0	1,362.0	1,788.9	1,983.3	6,434.0	7,117.0



# equipment markets 1

France		Italy		Netherlands		Norway		Spain	
1968	1969	1968	1969	1968	1969	1968	1969	1968	1969
23.0	25.5	21.5	21.0	7.5	7.9	2.0	2.3	4.9	5.4
57.9	53.5	35.8	34.7	9.0	10.4	6.5	6.9	13.5	13.9
15.6	18.5	11.1	14.5	4.9	5.4	2.3	2.5	0.7	0.8
205.0	207.5	190.0	180.0	34.0	29.0	11.6	11.8	67.0	70.0
28.0	55.0	*	0.3	9.0	17.0	*	*	*	*
17.5	18.5	6.0	7.0	4.5	5.0	2.0	2.1	0.8	0.8
<b>347.0</b>	<b>378.5</b>	<b>264.4</b>	<b>257.5</b>	<b>63.6</b>	<b>74.7</b>	<b>24.4</b>	<b>25.6</b>	<b>86.9</b>	<b>90.9</b>
1.9	2.4	1.7	1.6	1.4	1.4	0.7	0.7	0.4	0.5
1.5	1.8	0.3	0.3	0.3	0.3	*	*	0.3	0.4
2.6	3.2	0.6	0.9	0.5	0.6	0.2	0.3	0.4	0.5
4.7	4.9	3.7	3.8	1.7	1.8	0.8	0.8	2.1	2.3
12.0	14.7	2.1	2.8	4.2	5.2	1.3	1.4	0.4	0.5
5.1	5.7	1.4	1.6	2.5	2.9	1.5	1.5	1.2	1.3
<b>27.8</b>	<b>32.7</b>	<b>9.8</b>	<b>11.0</b>	<b>10.6</b>	<b>12.2</b>	<b>4.5</b>	<b>4.7</b>	<b>4.8</b>	<b>5.5</b>
31.0	31.5	9.4	8.2	5.0	5.5	6.0	6.6	6.3	6.5
3.6	4.5	2.4	2.6	1.0	1.1	0.1	0.3	0.2	0.2
23.5	25.5	5.2	5.4	5.5	6.0	2.0	2.3	1.1	1.1
27.4	28.2	7.0	9.1	3.9	4.7	1.6	1.8	1.1	1.1
29.8	31.3	11.0	12.9	10.1	9.1	5.1	3.1	2.4	3.1
115.0	115.0	36.0	42.0	40.0	42.0	16.0	19.1	6.5	7.0
46.0	46.2	10.6	14.2	5.7	6.2	2.4	2.7	4.5	4.7
30.6	31.0	2.4	2.7	1.5	1.5	0.9	0.9	0.3	0.4
6.5	8.5	0.2	1.0	0.7	0.5	0.5	0.5	*	*
25.5	27.1	6.0	6.5	9.0	9.6	1.5	1.8	1.7	1.7
<b>338.9</b>	<b>348.8</b>	<b>90.2</b>	<b>104.6</b>	<b>82.4</b>	<b>86.2</b>	<b>36.1</b>	<b>39.1</b>	<b>24.1</b>	<b>25.8</b>
6.0	7.0	3.0	3.6	1.2	1.2	0.9	1.0	0.8	1.0
3.5	4.2	1.5	2.0	1.0	1.2	0.5	0.6	0.4	0.5
194.0	236.0	115.0	143.9	39.0	47.0	23.9	27.8	17.5	19.7
32.0	38.5	19.5	24.5	3.2	3.8	0.9	1.1	0.5	0.6
12.0	15.0	7.8	9.8	3.2	3.9	0.7	0.8	0.7	0.8
19.0	23.9	11.0	12.7	8.5	10.5	1.3	1.4	5.0	5.2
<b>266.5</b>	<b>324.6</b>	<b>157.8</b>	<b>196.5</b>	<b>56.1</b>	<b>67.6</b>	<b>28.2</b>	<b>32.7</b>	<b>24.9</b>	<b>27.8</b>
4.2	4.2	1.6	1.6	1.8	1.8	0.6	0.6	1.0	1.0
3.5	3.5	1.6	1.6	1.5	1.6	0.5	0.5	0.3	0.3
3.8	3.8	1.9	2.0	1.8	1.9	0.4	0.5	0.4	0.4
3.0	3.0	1.0	1.0	2.0	2.0	0.5	0.5	0.4	0.4
1.5	1.6	0.8	0.9	0.8	0.8	0.3	0.3	0.1	0.1
7.0	6.5	3.0	3.1	1.5	1.5	0.7	0.7	0.6	0.7
<b>23.0</b>	<b>22.6</b>	<b>9.9</b>	<b>10.2</b>	<b>9.4</b>	<b>9.6</b>	<b>3.0</b>	<b>3.1</b>	<b>2.8</b>	<b>2.9</b>
4.5	5.0	1.8	2.0	1.8	1.9	0.4	0.5	0.3	0.3
5.0	5.5	1.8	2.0	1.9	2.0	0.4	0.5	0.4	0.4
14.0	15.0	5.3	5.8	3.2	3.3	0.7	0.7	0.7	0.9
7.2	8.0	3.1	3.6	7.2	7.9	3.7	4.1	2.7	2.9
7.9	8.5	4.8	5.3	5.0	5.5	1.3	1.4	2.9	3.2
2.2	2.2	1.0	1.0	1.2	1.3	0.3	0.4	0.2	0.3
83.0	91.0	43.0	50.8	31.5	35.0	12.7	14.0	14.1	15.1
5.0	5.5	1.6	1.7	1.1	1.1	0.1	0.2	1.9	2.3
25.0	28.3	10.0	11.7	4.7	4.7	1.8	2.1	2.8	3.0
<b>153.8</b>	<b>169.0</b>	<b>72.4</b>	<b>83.9</b>	<b>57.6</b>	<b>62.7</b>	<b>21.4</b>	<b>23.9</b>	<b>26.0</b>	<b>28.4</b>
1.7	1.8	0.5	0.6	0.6	0.6	0.1	0.1	0.1	0.1
3.2	3.2	1.8	1.9	3.2	3.3	0.3	0.4	0.3	0.3
3.8	4.0	2.2	2.3	3.2	3.1	0.5	0.5	0.2	0.2
3.1	3.4	2.7	3.2	2.2	2.6	0.3	0.3	0.4	0.4
6.5	7.1	3.3	3.5	3.5	4.0	0.6	0.7	0.3	0.4
7.0	8.0	4.2	4.5	6.2	6.4	2.5	2.7	0.1	0.1
3.6	3.8	1.4	1.6	1.6	1.8	0.2	0.2	0.3	0.4
17.1	18.9	7.8	8.5	7.9	8.2	1.5	1.7	1.2	1.4
4.0	4.3	3.5	3.8	4.5	4.8	0.5	0.5	0.6	0.6
10.4	10.9	5.1	5.6	6.6	6.9	1.1	1.1	0.8	1.0
3.5	3.6	4.3	4.7	3.2	3.4	0.5	0.7	0.5	0.6
1.0	1.0	0.7	0.7	1.0	1.2	0.2	0.3	0.1	0.2
18.0	20.5	7.3	7.9	5.0	5.5	0.6	0.7	0.9	1.0
<b>82.9</b>	<b>90.5</b>	<b>44.8</b>	<b>48.8</b>	<b>48.7</b>	<b>51.8</b>	<b>8.9</b>	<b>9.9</b>	<b>5.8</b>	<b>6.7</b>
<b>1,239.9</b>	<b>1,366.7</b>	<b>649.3</b>	<b>712.5</b>	<b>333.7</b>	<b>364.8</b>	<b>126.5</b>	<b>139.0</b>	<b>175.3</b>	<b>188.0</b>

usted to account for fiscal and monetary measures taken since then.



# European component

COMPONENTS, in millions of dollars <sup>1</sup>	Belgium- Luxembourg		Denmark		France		Italy		Netherlands	
	1968	1969	1968	1969	1968	1969	1968	1969	1968	1969
Antennas	2.4	2.0	1.9	1.9	22.0	24.2	5.2	5.7	2.6	2.9
Capacitors, fixed and variable	6.5	6.9	3.3	3.5	57.0	63.0	16.0	17.2	9.2	9.5
Coils, including intermediate frequency	2.0	2.2	0.3	0.4	13.0	13.5	5.0	5.7	2.2	2.6
Connectors	2.2	2.2	1.3	1.3	25.6	27.5	8.7	9.4	4.3	4.7
Crystals and crystal filters	0.6	0.7	0.7	0.8	2.8	3.1	1.8	2.0	1.1	1.2
Delay lines	0.6	0.7	0.2	0.3	2.1	2.6	1.0	1.3	0.9	1.0
Ferrite devices	1.2	1.3	0.5	0.6	6.1	6.7	2.9	3.1	2.2	2.4
Filters and networks (except crystal)	0.6	0.6	0.3	0.4	4.0	4.4	1.6	1.7	0.9	1.0
Loudspeakers	2.0	2.1	0.6	0.7	8.4	8.6	4.3	4.9	2.0	2.3
Magnetic tape	2.5	2.7	1.2	1.3	8.4	9.5	6.4	7.4	2.8	3.2
Potentiometers	1.1	1.2	0.8	1.0	10.5	11.1	4.9	5.3	2.5	2.8
Power supplies (OEM type)	2.3	2.4	1.5	1.6	9.0	10.0	8.5	9.0	5.8	6.5
Printed circuits	2.5	2.7	1.2	1.3	9.8	11.2	2.1	2.3	2.8	3.1
Relays	4.9	4.9	2.6	2.7	32.0	38.6	12.5	13.1	5.9	6.2
Resistors, fixed	4.0	4.0	1.2	1.3	22.1	24.6	8.7	9.1	4.8	5.3
Semiconductors, diodes <sup>2</sup>	2.3	2.5	1.0	1.1	13.1	13.3	3.0	3.1	1.9	2.0
Semiconductors, integrated circuits <sup>3</sup>	1.6	2.5	0.3	0.4	11.5	18.0	3.6	5.4	2.3	3.5
Semiconductors, transistors	4.6	5.3	3.9	4.2	47.0	48.0	15.4	16.1	7.6	7.0
Semiconductors, other <sup>4</sup>	2.3	2.7	0.7	0.8	16.0	17.5	6.4	7.9	4.5	5.1
Servos and synchros	0.8	0.8	0.2	0.2	4.7	4.5	1.6	1.7	2.0	2.1
Switches, manual	1.2	1.3	0.8	0.9	9.0	9.1	2.3	2.5	2.0	2.2
Transducers	1.5	1.5	0.6	0.7	11.0	13.0	4.1	4.3	1.9	2.0
Transformers and chokes	6.0	6.1	3.0	3.2	20.5	22.5	10.9	11.8	9.5	9.8
Tubes, receiving types	3.6	3.2	1.0	1.0	22.2	23.4	17.0	16.3	14.0	12.0
Tubes, power types	2.0	2.1	1.1	1.1	20.0	22.4	12.8	13.2	7.2	7.3
Tubes, picture	7.2	7.9	1.8	2.1	30.2	38.2	23.0	20.4	23.0	27.0
<b>TOTAL CONSUMPTION, components</b>	<b>68.5</b>	<b>72.5</b>	<b>32.0</b>	<b>34.8</b>	<b>438.0</b>	<b>488.5</b>	<b>189.7</b>	<b>199.9</b>	<b>125.9</b>	<b>134.7</b>

**Electronics'  
consensus  
forecast**

NOTE: Chart does not include  
with those published

1—Includes components

2—Diodes rated 200

3—Includes both mono

4—Includes diodes r

\*Less than \$75,000.



# ts markets 1969

s	Norway		Spain		Sweden		Switzerland		United Kingdom		West Germany		TOTAL	
	1968	1969	1968	1969	1968	1969	1968	1969	1968	1969	1968	1969	1968	1969
	2.0	2.0	5.7	5.9	2.5	2.8	3.0	3.1	10.2	10.7	40.0	44.0	97.5	105.2
	3.0	3.0	5.2	5.7	9.7	10.4	6.7	7.6	54.9	58.0	70.3	76.1	241.8	260.9
	0.4	0.4	0.9	1.0	1.1	1.2	0.5	0.6	12.8	13.7	19.0	20.5	57.2	61.8
	1.7	1.7	3.1	3.4	2.8	3.0	3.6	3.8	35.4	37.8	23.0	24.8	111.7	119.6
	0.5	0.6	0.4	0.5	1.0	1.0	1.0	1.1	8.6	9.1	3.3	3.7	21.8	23.8
	0.2	0.2	0.1	0.1	0.5	0.5	0.4	0.4	2.1	2.1	2.9	3.1	11.0	12.3
	0.8	0.9	0.4	0.5	1.1	1.2	1.2	1.4	11.8	11.9	11.0	13.2	39.2	43.2
	0.5	0.5	0.2	0.3	0.8	0.9	0.5	0.5	5.6	6.0	4.5	5.6	19.5	21.9
	0.8	0.9	1.8	2.1	0.8	0.9	0.6	0.6	8.7	9.4	15.3	17.4	45.3	49.9
	1.2	1.3	1.3	1.5	2.4	2.8	2.2	2.5	7.1	8.1	9.2	11.1	44.7	51.4
	0.7	0.8	1.7	1.9	1.7	2.1	1.3	1.7	15.6	16.7	17.1	18.5	57.9	63.1
	1.3	1.4	1.2	1.3	3.0	3.2	1.5	1.5	7.4	7.8	11.4	12.5	52.9	57.2
	1.2	1.3	0.3	0.4	3.0	3.1	1.4	1.5	8.0	7.5	8.0	8.5	40.3	42.9
	2.5	2.6	2.7	2.9	6.9	7.5	4.6	4.9	20.3	21.5	43.0	46.6	137.9	151.5
	1.2	1.3	1.9	2.2	4.0	4.0	2.9	3.2	26.2	27.2	30.3	31.3	107.3	113.5
	0.6	0.5	0.6	0.7	1.9	2.0	2.3	2.5	14.2	14.1	16.2	16.8	57.1	58.6
	0.4	0.8	0.1	0.2	1.3	2.2	2.0	3.0	21.9	32.1	13.7	20.5	58.7	88.6
	2.7	3.0	3.5	3.8	6.0	6.4	5.1	5.0	39.1	39.3	47.5	48.3	182.1	186.4
	0.5	0.6	0.3	0.4	2.4	2.5	0.6	0.7	15.5	17.2	14.0	16.0	63.2	71.4
	0.1	0.1	0.2	0.2	1.2	1.3	0.3	0.3	3.1	3.3	6.0	6.0	20.2	20.5
	1.5	1.6	1.0	1.1	1.4	1.5	1.2	1.2	14.6	15.5	15.7	17.3	50.7	54.2
	2.8	2.9	0.3	0.3	1.8	1.9	1.0	1.0	8.7	9.5	16.3	16.5	50.0	53.4
	3.5	3.6	4.5	4.9	7.5	8.2	5.7	5.7	23.0	25.0	41.5	43.5	135.6	144.3
	0.5	0.5	5.0	5.0	2.3	2.1	1.7	1.6	27.1	26.2	25.6	23.4	120.0	114.7
	0.7	0.7	2.1	2.3	3.3	3.5	2.3	2.6	39.2	40.2	27.5	29.7	118.2	125.1
	1.3	1.3	8.4	8.6	4.9	5.6	3.4	3.7	41.0	44.5	67.5	74.5	211.7	233.8
	32.6	34.5	52.9	57.2	75.3	81.8	57.0	61.7	482.1	514.4	599.8	649.4	2,153.8	2,329.4

clude estimates for cabinets, hardware, subassemblies, and wire and cables; totals therefore should not be compared directly  
ned in previous years. Estimates are based on currency exchange rates in effect on Nov.15, 1968.

ents used to produce equipment both consumed domestically and exported. Factory prices, imports valued at cost-insurance-freight.  
milliamps or lower.

olithic and hybrid integrated circuits.

ated higher than 200 ma, silicon controlled rectifiers, light-emitting devices, etc.



ASSEMBLED EQUIPMENT, in millions of dollars <sup>1</sup>		Belgium-Luxembourg		Denmark	
		1968	1969	1968	1969
<b>CONSUMER PRODUCTS</b>	Phonographs and radio combinations	6.5	7.0	1.9	2.1
	Radios (includes car radios)	7.5	7.5	5.8	6.1
	Tape recorders (for home use)	1.2	1.3	3.3	3.6
	Television sets, black and white	28.0	26.6	15.1	16.6
	Television sets, color	0.8	2.2	2.5	4.5
	Other consumer products	4.2	4.3	2.5	2.6
	<b>TOTAL</b>	<b>48.2</b>	<b>48.9</b>	<b>31.1</b>	<b>35.5</b>
<b>MEDICAL EQUIPMENT</b>	Analytical laboratory equipment, electronic	1.2	1.2	0.6	0.7
	Diathermy (short wave) equipment	0.1	0.1	*	*
	Electrocardiographs and electroencephalographs	0.5	0.7	0.2	0.3
	Hearing aids	1.5	1.6	0.9	1.0
	X-ray equipment	3.9	4.9	1.5	1.5
	Other medical electronic equipment	2.3	2.3	1.4	1.5
	<b>TOTAL</b>	<b>9.5</b>	<b>10.8</b>	<b>4.6</b>	<b>5.0</b>
<b>COMMUNICATIONS EQUIPMENT</b>	Broadcast equipment	13.0	3.5	4.0	4.4
	Closed circuit television	0.8	1.0	0.4	0.5
	Intercoms and sound systems	4.0	4.4	1.9	2.0
	Land-mobile	2.5	3.0	3.4	3.8
	Microwave relay systems	3.5	3.8	3.5	3.9
	Navigational equipment, air and marine	28.6	31.2	11.6	3.1
	Radar	3.0	3.5	3.1	3.3
	Telemetry	1.2	1.2	0.8	0.9
	Telephone switching, electronic	0.1	1.0	0.1	0.1
	Other communications equipment	6.0	6.5	2.3	2.3
	<b>TOTAL</b>	<b>62.7</b>	<b>59.1</b>	<b>31.1</b>	<b>34.3</b>
<b>COMPUTERS AND RELATED EQUIPMENT</b>	Analog and hybrid computers	1.5	1.5	0.3	0.3
	Converters: analog-digital, digital-analog	0.6	0.7	0.3	0.6
	Digital computers, except for process controls	43.0	51.2	21.9	25.2
	Memories	1.1	1.3	0.9	1.1
	Readers and readout devices	2.4	3.1	0.6	0.7
	Other computer-related equipment	8.0	9.4	1.8	1.9
	<b>TOTAL</b>	<b>56.6</b>	<b>67.2</b>	<b>25.8</b>	<b>29.8</b>
<b>NUCLEAR INSTRUMENTS AND EQUIPMENT</b>	Accelerators	1.0	1.0	0.4	0.4
	Analyzers	1.4	1.4	0.3	0.3
	Radiation—monitoring equipment	1.2	1.3	0.5	0.5
	Reactor controls	0.9	0.9	0.3	0.3
	Semiconductor and other detectors	0.7	0.7	0.1	0.1
	Other nuclear instruments and equipment	1.9	1.9	0.9	0.9
	<b>TOTAL</b>	<b>7.1</b>	<b>7.2</b>	<b>2.5</b>	<b>2.5</b>
<b>INDUSTRIAL EQUIPMENT</b>	Dictating machines	1.0	1.0	1.2	1.4
	Industrial X-ray equipment	0.9	0.9	0.8	0.9
	Infrared equipment	3.7	3.8	0.8	0.8
	Machine tool controls	4.2	4.6	3.4	3.7
	Motor controls	4.1	4.5	2.0	2.2
	Photoelectric devices	0.1	0.1	0.3	0.3
	Process controls and systems (including computers)	38.0	40.1	11.6	12.7
	Welding equipment	0.3	0.4	0.2	0.2
	Other production and control equipment	8.0	8.6	1.7	1.8
	<b>TOTAL</b>	<b>60.3</b>	<b>64.0</b>	<b>22.0</b>	<b>24.0</b>
<b>TEST AND MEASURING INSTRUMENTS</b>	Amplifiers, laboratory type	2.5	2.5	0.1	0.1
	Calibrators and standards	0.6	0.6	0.2	0.2
	Components testers	1.2	1.5	0.5	0.6
	Counters	2.0	2.5	0.2	0.3
	Electronic voltmeters and ammeters	2.0	2.0	0.5	0.5
	Microwave test and measuring instruments	2.3	2.8	1.1	1.1
	Oscillators	1.2	1.3	0.3	0.3
	Oscilloscopes	4.7	5.2	1.5	1.6
	Power supplies, laboratory type	2.2	2.6	0.6	0.6
	Recorders	2.4	2.7	1.1	1.2
	Signal generators	1.2	1.5	0.4	0.4
	Spectrum analyzers	0.4	0.5	0.1	0.1
	Other test instruments	5.0	5.4	0.8	1.0
	<b>TOTAL</b>	<b>27.7</b>	<b>31.1</b>	<b>7.4</b>	<b>8.0</b>
<b>TOTAL CONSUMPTION, assembled equipment</b>		<b>272.1</b>	<b>288.3</b>	<b>124.5</b>	<b>139.1</b>

NOTE: Estimates are based on business conditions and currency exchange rates as of Nov. 15, 1968; they have not been ad

1—Estimated consumption at factory prices; imports valued at cost-insurance-freight.

\*Less than \$75,000.



# It's got to be good

Brisk trade winds blowing out of Germany will swell sales of electronics equipment throughout Western Europe no matter what countercurrents develop in France and Britain

Up with communications: General Post Office tower dominates London's skyline.

**Those clouds of smoke** over the Ruhr are signaling that industry is once again alive and well east of the Rhine. And when the West German economy is working its miracles, business most often is good throughout Western Europe.

To be sure, there are weak spots. A year after devaluation, Britain's economy is still hobbled by trade deficits. And France is trying to free herself from the fetters of monetary problems.

Britain next year will once again be hard put to right her trade balance. But the Labor government's latest round of economic measures is aimed at pushing industrial output up 4%—all the while curbing consumer spending. And despite monetary woes, France's economy looks basically strong and should stride out in 1969 despite de Gaulle's decision to cut back government spending in order to hold the line on the franc.

So barring another round of brickbats and barricades in France or an unexpected turn for the worse in the chronic ills of the pound sterling, Western Europe's economies should generally post strong gains next year, with electronics markets sharing fully in the growth. After surveying the outlook for 1969 in 11 countries this fall, Electronics magazine forecasts total equipment markets of \$7.12 billion, a gain of 10.6% from the \$6.43 billion estimated for 1968. Components sales are tallied separately.

## Set to climb

Although the Wilson government, the de Gaulle government, and the Franco government in Spain all intend to discourage consumer buying next year, the market for radios, phonographs, tape recorders, and television sets should flourish. Prospects are for consumer electronics sales of \$1.9 billion, up \$100 million from this year's market (throughout this report, markets are calculated in terms of factory sales). Color set sales, which have gone surprisingly well in Germany and Sweden this year, should shoot up nearly 45% to about

\$320 million in 1969. Black-and-white tv remains the mainstay of the market, though, and sales in this sector will slip slightly to about \$944 million.

To no one's surprise, the fastest growing sector of the market is data processing equipment. The forecast for next year's market is \$1.66 billion, a spurt of 19.5% from 1968. American companies—notably the International Business Machines Corp.—dominate this market and will for a long spell, but the European challenge gets a little stronger each year.

Also picking up steam are sales of electronic telephone exchange equipment. They will account for only \$35 million of the \$1.73 billion forecast for the over-all electronic communications market, but that \$35 million is nearly double the 1968 level and represents the first drops of what should become a flood of orders within a few years. Until the big countries on the Continent follow Belgium's lead and shift to electronic exchanges, though, the communications market will rise slowly.

## Follow the leader

Setting the 1969 pace for West European electronics once again will be West Germany with a \$1.98 billion equipment market. A good \$600 million behind are Britain and France, neck-and-neck at \$1.36 billion. But a year ago, before what the French call "the events," it looked as if France had an unshakeable hold on the number two spot. Among the smaller countries, Sweden has moved past Belgium as a market, according to the survey, largely because of color-tv sales.

As for components, the \$2.3 billion market in sight for 1969 represents a good gain of \$175 million from this year's level. (The market forecasts for this category cover total consumption of components

## Guide to European electronics markets

72	West Germany
76	United Kingdom
79	France
81	Italy
83	Sweden
85	The Netherlands
86	Belgium
87	Switzerland
88	Spain
89	Denmark
90	Norway



## EQUIPMENT MARKETS

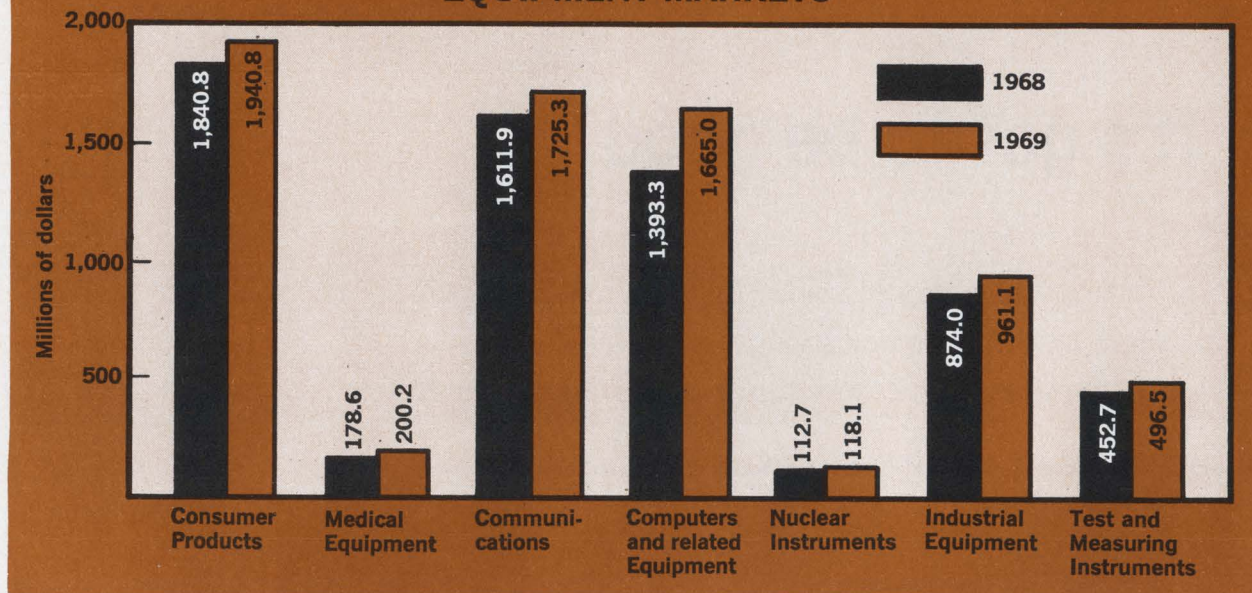

whether they're used in equipment sold domestically or exported.)

Continuing the trend of the past few years, integrated-circuit sales will soar again—this time from \$59 million to \$89 million. But there'll be a differ-

ence. For the first time consumer-set IC's will be used in significant quantities, particularly by West German manufacturers. In the history of electronics, 1969 may be remembered as the start of the consumer-IC era.

## German economy works miracles for all markets save avionics

**Seat-of-the-pants economists** say there's a sure and easy way to take a fast fix on business conditions in West Germany—get a head count on the Gastarbeiter, the foreign "guest workers" in the country.

These days, the dictum can't be disputed. A few minutes in the rail stations of industrial centers like Dortmund, Hanover, and Stuttgart is all it takes to confirm that the Gastarbeiter are flocking back. At the same time, by-the-book economists are estimating the growth of the over-all German economy this year at a boom-tinged 6%. And they're predicting another strong rise for 1969, despite a continuing labor shortage and some mild braking by the ersatz revaluation in November that made German goods dearer in export markets and imports cheaper in Germany.

For the country's electronics industry—Europe's largest—it all smacks of the good old days of the late 1950's and early 1960's. Then, the industry considered a 10% annual gain the normal course

of events. Things will be back to normal next year, another economic miracle when you consider that Germany just started recovering from a slump 20 months ago. The 1969 rise will carry the West German market—components excluded—to \$1.98 billion, according to Electronics magazine's survey, nearly \$195 million above this year's estimated total.

Almost all sectors of electronics can count on a piece of the action. "Consumer electronics will rise along with the gross national product," says Horst Schikarski, market planning manager at Kuba-Imperial GmbH. The tight labor supply figures to buoy sales of industrial electronics gear. A bigger budget for the post office, which runs the country's telephone network, means more business for the communications sector. And along with a lift from their traditional customers, components makers will get a leg up from new buyers—notably auto producers and camera makers.

Nonetheless, the industry has its poor cousins,



chiefly the avionics makers. With big international aircraft projects jelling slowly, these producers at the moment don't know where they'll land next year. More defense spending seems certain in the aftermath of the unsettling Czechoslovakian crisis. But any added military spending most likely will benefit U.S. electronics producers more than German ones because Bonn is committed to buy American hardware to offset the costs of keeping U.S. troops in Germany.

### Ever upward

In good times or bad, it seems, the computer business continues to surge. Electronics magazine forecasts a West German market of \$465 million for computers and peripherals next year, up a heady 17% from the 1968 figure of \$399 million.

West German computer-market watchers believe this kind of growth can continue until the early 1970's, although orders for new machines have started to slacken slightly. By 1975, it's predicted, between 7,000 and 8,000 systems will be spewing out data in the country. There are now some 4,800 systems in service, and they are worth an estimated \$1.36 billion.

If there's a discernible trend in next year's market, it's toward larger machines. Machines renting for \$20,000 a month or more will account for much of the 1969 gain. The computers in this class most likely to succeed are the International Business Machines Corp.'s 360/50 and Siemens AG's 400/45, along with the larger models in these lines.

There's also a strong move toward remote terminals, as banks, airlines, and hotel associations link outlying stations to their headquarters computers. But German businessmen are still wary about sharing computers. So far, there's only one time-shared computer utility in Germany and its clients are mainly engineering firms.

The predicted \$320 million market for business and scientific computers next year will go mostly to U.S. companies; IBM alone can count on a share of nearly 65%. In process-control computers, though, German companies dominate. Siemens, the country's largest electronics producer, says it has cornered 45% of the market. AEG-Telefunken, the second largest German electronics firm, will snap up something like 25% to 30% of the process-control business.

And a good business it is. Electronics magazine forecasts a 10% rise in sales of industrial equipment next year to \$265.5 million, and process-control systems will account for nearly half that total. Klaus Anke, manager of Siemens' automation engineering division, says about 250 process-control computers will be installed or ordered during the next 12 months, half again the 1968 figure.

Public utilities and steel makers are still the prime customers, but cement and petrochemical processors are joining the lineup. Siemens, for example, this fall got an order for a pair of computers for a new refinery Mobil Oil AG is building. Anke also sees pipeline and waterworks control as

## German electronics market forecasts

(millions of dollars)

	1968	1969
<b>Assembled equipment, total</b>	<b>1,788.9</b>	<b>1,983.3</b>
Consumer products	539.5	582.3
Medical equipment	56.4	63.2
Communications	418.0	458.6
Computers and related equipment	399.3	465.4
Nuclear instruments and equipment	22.9	23.9
Production, control and other industrial equipment	240.2	265.5
Test and measuring equipment	112.6	124.4
<b>Components</b>	<b>599.8</b>	<b>649.4</b>

a potential job for process computers. There's promise, too, in air-conditioning systems for big buildings.

And the industrial electronics market looks good for the long run. Hans-Erhardt von Knobloch, general manager of AEG-Telefunken's industrial equipment division, expects the European market for automation gear to rise at an annual rate of at least 10% over the next few years. The constant increase in wages is one factor that will keep sales of automation equipment on the rise. And the rapid obsolescence of existing hardware provides an added push. Manufacturers are finding they must buy new control gear to keep up with their competitors.

### Spreading the word

Another drive to keep up—this time by the Federal Post Office—is the key to the communications market. Far and away the country's leading consumer of communications hardware, the post office is going into the second year of its five-year, \$3.6-billion effort to expand its network at a pace matching the staggering growth of the traffic it must handle—words, pictures, and particularly data. Johannes Sedlartz, manager of marketing services at Standard Elektrik Lorenz, an ITT subsidiary, estimates that the post office would have to double its network within five years—which it can't, of course—to meet the potential demand for data-transmission lines.

The agency's budget for the year ahead includes \$600 million for telecommunications hardware, some 9% more than this year's allocation. The exact percentage of this that will go for electronics equipment can't be sorted out. But it will certainly be enough to keep the over-all market for communications gear on a strong upward trend. Electronics' forecast pegs the increase at 10% from 1968, carrying the total to \$459 million.

Along with the needs of such traditional markets as telephone carrier equipment and radio links,



communications equipment makers are meeting some new demands. The government's aerospace research organization, for example, is setting up an extensive satellite monitoring station at Lichtenau in Bavaria. The station is scheduled to go into service when Germany's first research satellite, the Azur, is launched next fall. Werner Fogy, manager of the project, estimates the cost of Lichtenau's instrumentation—the antennas, a computer, and test equipment—at between \$2 million and \$2.25 million. The computer, a Siemens 305, will be used for around-the-clock station control.

The Lichtenau facility will be the hub of an international monitoring network stretching from Alaska to northern Europe. Another German segment of the network will be a control center at Oberpfaffenhofen, where Siemens will install \$1.25 million worth of data-handling equipment, including another 305 computer. "Even though we don't have rocket-launching facilities of our own, our ground terminals will at least provide us with a small window into space," Fogy says.

The window will soon get other panes. Already projected is a second phase of the program in which several satellite-orbit calculating sites will be added to the network beginning in 1970 or 1971.

Also helping keep communications producers busy is Germany's second satellite ground terminal at Raisting in Bavaria. The \$7 million terminal, due for completion next July, will use about \$2.2 million worth of electronics gear supplied by Siemens and Telefunken.

The market will also be bolstered by subcontracts covering the German share of big international satellite projects. Telefunken, for instance, has picked up \$3 million of business from the Communications Satellite Corp., which late this year let a contract to a 10-nation consortium headed by the Hughes Aircraft Co. Telefunken will supply communications gear and solar cells for the projected satellite.

West Germany's communications firms won't get a shot at the big market in electronic telephone switching until the early 1970's, though. The post office and the industry have so far installed four small electronic exchanges and must evaluate them before moving on to the design of a basic system built around integrated circuits. The post office is also testing four pulse-code-modulation systems and next year will try out a waveguide link 1.8 miles long running underground through Darmstadt's urban area.

### Shopping spree

The return of good times has stirred a consuming passion in West Germany and the public is satisfying its urge to buy in good measure with television sets and radios.

The mild boom that started early this summer shows no sign of abating; set makers' problems at the moment are mainly keeping dealers supplied. Such is the state of the market that a rise next year of about 8%—very sharp for the consumer

electronics field—seems a sure bet for 1969. Electronics magazine's forecast puts 1969 sales at \$582 million, up from an estimated \$540 million this year.

There'll be a slight decline in sales of black-and-white tv sets next year, but that prospect troubles no one even though monochrome receivers are the market's mainstay. Color sets—selling at two and a half or three times the prices of black-and-white sets—once again will come on strong. By 1970, some people in the industry say, there'll be as many Deutsche marks spent on color sets as on monochrome sets. This year, according to Electronics' survey, monochrome sales, at \$215 million, were nearly double color sales.

Everyone agrees that sales of color sets next year will top the combined 340,000-unit total racked up during 1967 and 1968, but by how much is a moot question.

Bullish forecasts of 400,000 sets are coming from the market seers of Norddeutsche Mende Rundfunk KG, better known as Nordmende, and Deutsche Philips GmbH, a subsidiary of Philips' Gloeilampenfabrieken of the Netherlands. Guenther Huecking, head of the radio and television section of the West German electrical-electronics industry's trade association, sides with the bulls. Most bearish is Kuba-Imperial, an affiliate of the General Electric Co. Kuba pegs the market at 350,000 units. The bulls predominate, though, and the consensus forecast is \$145 million in 1969 color sales.

There's plenty to support a forecast on the high side. Programing, in the opinion of many European marketers an underrated factor in color tv sales, has reached eight to 10 hours a week on each of the two national networks. Then, too, set prices—already the lowest in Europe at \$550 retail for a 25-inch model—are slowly moving even lower.

Above all, there's the replacement market. Ulrich Prestin, Nordmende's product planning manager, figures that four of every 10 people seeking a replacement for a black-and-white set buy a color receiver. "To a lot of people it just doesn't make sense to invest in another black-and-white set with a lifetime of 11 years or so," Prestin says.

Next year's black-and-white market, like this year's, will be marked by a slow decline in sales and by cutthroat pricing. Huecking predicts sales of 1.5 million sets, down 200,000 from 1968.

Black-and-white prices under \$100 are becoming common, and all the major producers are emphasizing low-cost sets. Saba GmbH, the last holdout, has dropped its "quality-only" policy and in 1969 will join the bargain-basement scramble.

Although profit margins in this scramble are slim, few firms are thinking of pulling out. The market is actually far from saturated. Only 67% of West Germany's 21.7 million households now have a tv set. Attainable, in the view of the industry's trade association, is a boost to between 85% and 90%; that works out to between 4 and 5 million more sets.



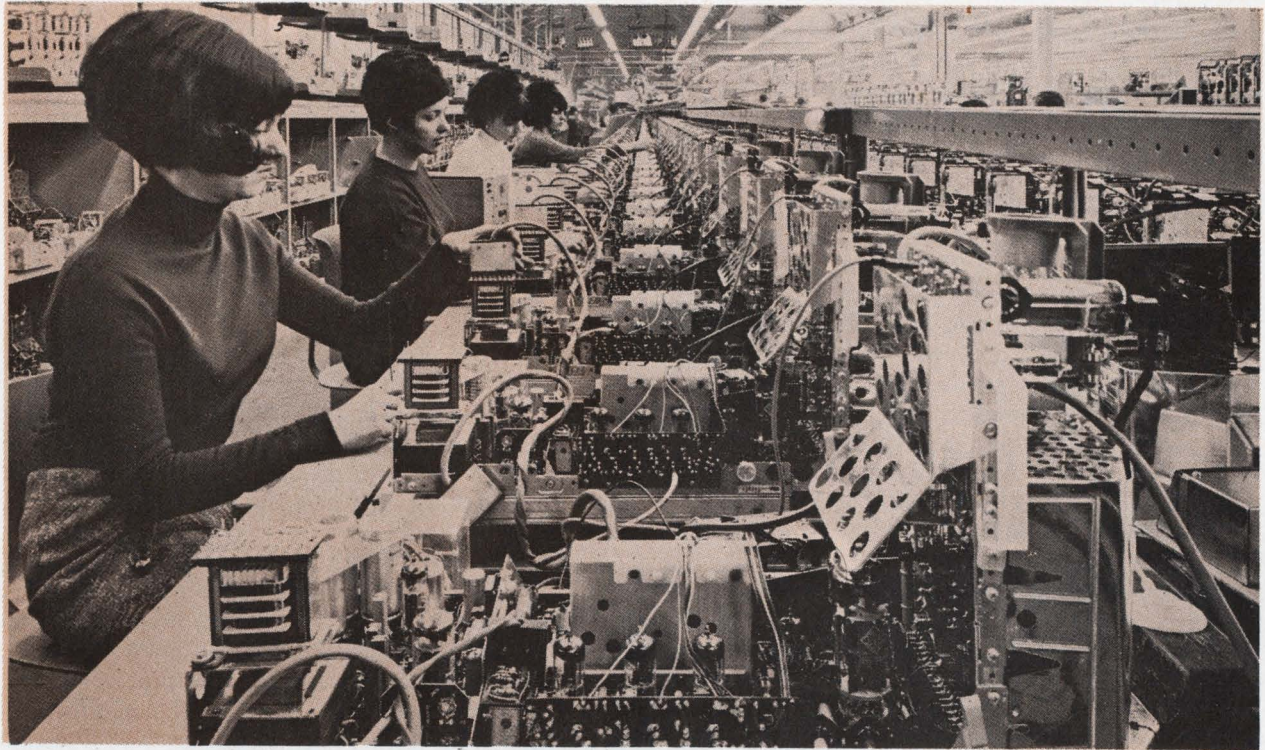

**Counting on chrominance.** West German set makers have geared their production lines to turn out at least 350,000 color tv receivers next year.

As for radio sales, they should hold next year at this year's level of \$115 million. And the trend to two distinct markets will continue. The one for cheap monaural sets is dominated by the Japanese. The other covers expensive radios and hi-fi and stereo combinations. "There won't be much offered in between," says Nordmende's Prestin, who tracks the radio market closely.

### Bits and pieces

With their customers gearing up for a big year, components makers can look forward to a great year.

Electronics magazine predicts a rise in next year's market to \$650 million from this year's estimated \$600 million. But some components producers consider this forecast of a 8% gain much too low. In fact, one heavyweight in the industry expects a rise of nearly 20%, largely because the surge in the equipment market will be compounded by a firming up of component prices. Even the semiconductor makers, who waged a grim price war in 1967 and skirmished with each other this year, see a truce of sorts in the offing for 1969. Prices for diodes, transistors, and integrated circuits will continue to decline, but they won't plummet.

The strength of color tv sales, of course, portends well for components makers. The parts bill for a color set is about three times as large as the one for a black-and-white set. The shadow-mask tubes alone—priced between \$125 and \$145

a copy—account for some 7.5% of the country's components consumption.

And besides serving their traditional markets—consumer goods, communications equipment, computers, and control equipment—the parts people are taking on a new one with a tremendous potential—autos. An intimation of what's ahead comes from Volkswagen, Germany's leading automaker. Since it installed an electronics fuel-injection control in some VW 1600 models late last year, the company has sold 150,000 of the cars so equipped, and this adds up to 3.75 million transistors. All this points to the eventual use of astronomical numbers of components every year by the auto industry.

When that time comes, integrated circuits should be entrenched in the consumer market. A beachhead, in fact, will be established next year. Grundig Werke GmbH says all its monochrome sets and most of its color sets will have an IC in their sound stage. And most of the 1969 receivers from Korting Radio Werke GmbH will be equipped with an IC; this year's Korting portables already have them.

In contrast with these two south German companies, northern producers like Nordmende, Kuba, and Blaupunkt continue to view IC's largely as promotional gimmicks. But they, too, may be heavy buyer's of IC's before the next 12 months are up.

No matter what the set makers decide, there's a stunning increase in the offing for IC's—at least 50% next year. That would add up to a market of \$20.5 million.



# Curbs on consumer buying won't bar gains in Britain

**British consumers** are an enthusiastic lot, as the mobs of miniskirted shoppers on London's Carnaby Street and King's Road attest. But a damping of this enthusiasm will be a major 1969 goal of Prime Minister Wilson and his Labor government.

The curbs on consumers are yet another treatment in the series the Wilson government has prescribed for Britain's long-ailing economy, whose most telling symptom is a chronic balance of payments deficit. To remedy that, the government late last year tried the most painful therapy of all—devaluation. So far, this treatment—which makes exports more competitive and imports more expensive—hasn't turned the trick. Its effect, though, was heightened last month by an import-deposit scheme that presents much the same sort of barrier as a 2% rise in tariffs.

All this, the government hopes, will right the balance of payments but still permit Britain's industrial production to grow by some 4% next year. As usual, the government is backing industries that export heavily and investments in things like computers and automated assembly lines that make them more competitive. So Britain's electronics industry can count on a good year despite two major drawbacks: a tight-fisted Chancellor of the Exchequer and a disappointing outlook for home-entertainment equipment. Electronics magazine forecasts the 1969 market at \$1.36 billion, up a solid 10% from this year's estimated figure.

As for components, the survey indicates a rise to \$514 million next year, 6% above the \$482 million estimated for this year. In components particularly, the government's import-deposit scheme should give native producers a bigger share of the market.

There's sharp price competition in the sector, and the new barrier could curb the spurt in components imports—about 30% this year and last.

## Buying British

It remains to be seen how well domestic components makers will fare in their efforts at "import substitution"—the euphemism in vogue at the moment for "Buy British." But there's no doubt that British computer makers will continue to hold their own against IBM and the other U.S. heavyweights that dominate elsewhere in Europe.

Electronics' survey forecasts a 1969 computer market of \$339 million, some 20% higher than the estimated 1968 market of \$281 million. A good 40% of the business will go to International Computers Ltd., the company formed this year when the business-computer operations of the English Electric Co. were combined with those of International Computers & Tabulators Ltd.

From ICL's headquarters towering over the Thames at Putney Bridge, the word is that computer equipment imports have leveled off and that the market's growth—good as it is—is slowing down. The 20% rise predicted in the survey would look high to most ICL officials. John Insall, the company's market research manager, pegs over-all 1969 growth at "around 15%, but on the down side." Insall sees no change in the offing in the trend to larger data processing systems. Until 1966, he points out, systems costing from \$250,000 to \$500,000 made up half the British computer population. Since then, though, businessmen have been buying relatively more higher-priced systems.

The urge for business efficiency that keeps computers the fastest growing sector in British electronics also sends buyers flocking to the market for automation and control equipment. Industrial electronics, though far behind the pace set by computers, looks to be next year's second-best growth sector. The forecast: a market of \$148.5 million, up 8% from the \$137 million estimated for 1968.

There's plenty in the long-term outlook for controls makers to fret about, however. David Jenkins, a market watcher for George Kent Ltd., the company that flies the Union Jack in the instrumentation field, fears a downturn after 1969. He notes that the government-run electric utility is a major customer for electronic controls and that its generating-plant construction program is on a decline.

Then, too, the nationalized steel industry, another prime customer for controls, may cut back its investments as part of the government's contribution to a stronger pound sterling. And there's a potential hitch in another kingpin sector—chemicals. Companies in the field are holding off on

**British electronics market forecasts**  
(millions of dollars)

	1968	1969
<b>Assembled equipment, total</b>	<b>1,237.0</b>	<b>1,362.0</b>
Consumer products	315.2	330.5
Medical equipment	28.0	30.6
Communications	386.3	413.0
Computers and related equipment	280.8	339.1
Nuclear instruments and equipment	22.1	25.0
Production, control and other industrial equipment	137.4	148.5
Test and measuring equipment	67.2	75.3
<b>Components</b>	<b>482.1</b>	<b>514.4</b>



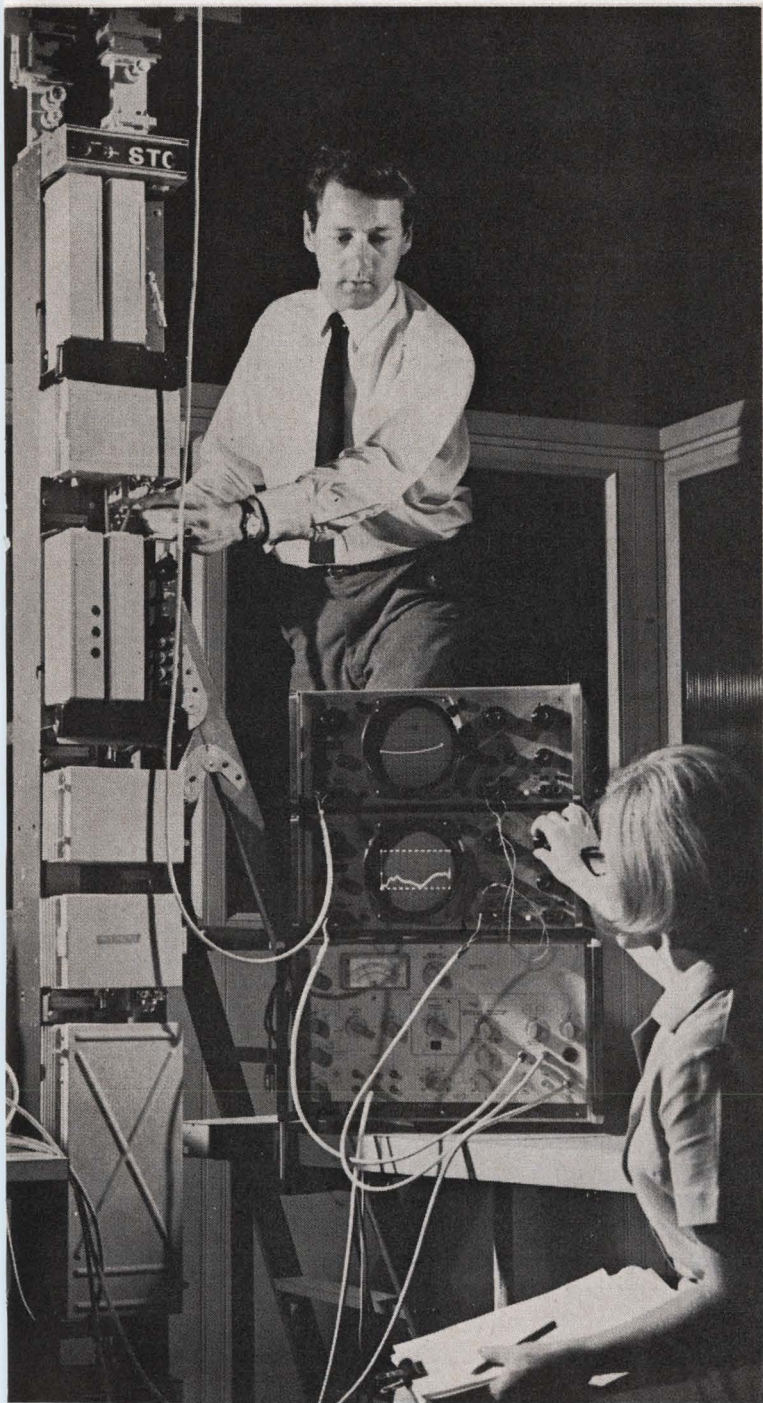

**For Scotland's links.** High-capacity microwave gear gets test at Standard Telephones & Cables. Firm will supply \$2.4 million of equipment for Scottish network.

orders for new big systems until the verdict is in on the merits of the first direct-digital-control plants.

But the chemicals producers are going ahead with orders for smaller systems such as tanker-terminal controls and laboratory automation equipment. John Heywood, a director of Elliott-Automation Systems Ltd., one of the companies in the British General Electric-English Electric group,

expects lab automation to expand at least 20% annually over the next five years.

### Heavier heavyweights

As with computers and ICL, "heavy" electronics this year got its giant, the combine formed when English Electric merged with British General Electric (not connected with its U.S. namesake). Last year, GEC acquired Associated Electrical Industries. So the group controls about a third of the British nonconsumer electronics and telecommunications business. This, together with sales of heavy electrical equipment, makes the group a peer—as far as total sales go—of Philips' Gloeilampenfabrieken, the largest electronics company in Europe.

The series of mergers that led to the giant consolidation could mean that the country's electronics industry will end up structured like the auto industry, where there are no medium-size companies, only very large ones and very small ones.

And in the British electronics business, it's medium-size companies that are having trouble keeping their profits up despite gains in sales. Electrical & Musical Industries Ltd., Decca Ltd., and Ferranti Ltd. are the industry's leading British-owned middleweights. Any or all of the three conceivably could join forces next year with the country's other truly native heavyweight systems builder, the Plessey Co. Plessey tried to bring English Electric into its fold but lost out to GEC.

Whether there's another big merger or not, the systems builders will have an exacting new best customer next year. In October, what's now the Post Office will cease existence as a government department and become an independent corporation with \$5 billion in its coffers to spend over the next five years on telecommunications systems. And to make sure everyone understands that as a business it plans to operate in a businesslike fashion, the Post Office has let it be known that if it can't get the right price for what it wants from traditional suppliers, it will look elsewhere.

Still, there's little chance that outsiders will make significant inroads in the British communications market, where the native companies are so strong. The market next year, according to Electronics magazine's survey, will rise 7% to \$413 million.

There'll be particularly good growth in telecommunications, what with the determination of the Post Office to refurbish an obsolescent telephone network. To be sure, the agency still hasn't moved to electronic switching for large exchanges. One reason it's holding off is to see how its experiments in switching pulse-code-modulation signals through exchanges turn out. But the spread of small (up to 2,000 lines) semielectronic exchanges continues. Five are now in service and the figure will be close to 200 by 1971. And next year there'll be heavy deliveries of pcm links, some \$15 million worth.

Another Post Office project that will keep order books plump in the years to come is a nationwide data-transmission network. It will operate at a 48,000-bit-per-second clip, 20 times as fast as the



current "high-speed" service. The first line—linking London, Birmingham, and Manchester—should be operating within a year, and there'll be a free trial period for users while the Post Office debugs the terminal equipment. Users will tie into this main data line through local telephone lines and pcm modems.

To be sure, there are soft spots in the U.K. communications market. For instance, there are no new Post Office orders in the offing for satellite ground stations.

But when there's a soft spot, there's usually compensating shoring elsewhere. In ground stations, there's a bracing export market. The Marconi Co.'s 1969 workload includes stations built around antenna dishes 90 feet in diameter for Bahrein, Hong Kong, and Kenya, and a trio of 40-foot stations for the British Skynet military communications system. Marconi, an English Electric affiliate, also figures to pick up an order for a 90-foot station in Jamaica.

The other two British ground-station builders, GEC and Plessey, are building portable terminals for Skynet but so far have nothing definite on their order books to follow. Both are angling for a piece of the \$30 million the North Atlantic Treaty Organization will spend for ground stations to match its own Skynet-like communications satellites. Plessey heads one consortium in the competition, GEC is a member of another, and Marconi a member of a third.

#### Up and away?

If U.K. avionics people seem unusually edgy these days, there's good reason. About the only sure thing on their horizon is a decline in their domestic market. And adding to their worries are the troubles in France. British producers had high hopes that the Anglo-French projects—the supersonic Concorde airliner and the Jaguar fighter-trainer—would help get them back in a cruising climb. Now President de Gaulle has cut back on the Concorde and may have to pull out of the project entirely. The Jaguar is less in jeopardy since its prototype, at least, has flown.

With all this to fret about, avionics producers are understandably looking for new fields to fly to even though business will be adequate next year. (Electronics' forecast shows a navigation equipment market, most of it for aircraft, of \$142 million, up just \$3 million from the 1968 figure.) Space is the direction some firms will take. The British Aircraft Corp. landed \$7 million worth of satellite work for the Intelsat 4 project this fall and that has started others thinking about space prospects.

#### Faded color

British consumer electronics makers were a somewhat bemused lot this year, lifted by an un-hoped-for spurt in monochrome tv sales and let down by disappointing sales of color sets. All told, though, the market this year shot up some \$40 million to \$315 million. Such a gain was surprising in light of government pressures to force consumer

spending down. Next year, Electronics magazine forecasts, the market will move up a bit to \$330 million. If the government's consumer curbs really work, this forecast will be high.

Most government economists say the sharp 1968 rise was largely the result of "dis-saving," as consumers, worried that the pound might sag again, turned their bank accounts into hardware. One result was a boomlet in black-and-white tv sets. At the year's outset, the industry figured it would sell about 1.4 million sets. The real figure will be closer to 1.6 million. With credit restrictions much tighter since last month, next year's outlook for black-and-white sales is for a downturn of some 100,000 sets.

There should be a more-than-offsetting gain, though, in color set sales. Receiver makers this year delivered about 125,000 sets to retailers and they in turn sold 80,000. Despite the new restrictions and the inventory buildup, producers expect to put another 150,000 sets into the pipeline in 1969. The retail market, they hope, will perk up with the advent of 22-inch sets and the extension of colorcasts—now the province of one "highbrow" network—to the two "lowbrow" networks next November.

#### MOS market

There should be few surprises next year in the \$500 million-plus British components market. There'll be big gains in semiconductors and picture tubes, but receiving tubes will continue their slow decline while power tubes hold their own.

The surge expected in integrated-circuit sales will take the market from this year's \$22 million to \$32 million, a 40% increase. With set makers facing potentially difficult days, there'll be no massive movement to get IC's into consumer products. One producer of portable radios, nonetheless, plans to start producing a set built around a Mullard TAD 100 linear circuit. Plessey next year will add to its wares an IC car radio and possibly a record player with a 5-watt (rms) audio amplifier. Most IC makers are readying consumer-quality packages, of course, for the mass debuts expected in 1970 or 1971.

All in all, linear circuits will account for about 15% of the U.K. market for IC's next year and digital circuits for about 75%. The remaining share will go to metal oxide semiconductor circuits.

The MOS market is still in its infancy in Britain and the native producers—Ferranti, Plessey, Associated Semiconductor Manufacturers Ltd., and Marconi-Elliott Microelectronics—see a chance to get at least one foot, but preferably both, in the door before U.S. producers move in as they have with bipolar.

Some very lucrative business could open up next year. The Post Office plans to try MOS switching arrays and control logic in telephone exchanges, automotive accessory makers will try MOS switching and timing devices in instrument circuits, and computer makers will extend the use of MOS in peripherals.



# Government spending slides in France as de Gaulle bids au revoir to grandeur

**Much to the consternation** of President de Gaulle and the bourgeoisie that backs his regime, a group of cantankerous Paris students last Spring called the turn for France's economy in 1969.

Aroused by the chanting, cobblestone-hurling universitaires, the country's workers put the Establishment through a cram course in the economics of upheaval. The immediate fee was \$3 billion in output lost by idled plants. Still to be fully reckoned are the other tuition costs—wage hikes, inflation, and a heavy outflow of reserves to bolster the franc.

Whatever the tab, France's electronics industry indirectly will pay a share. Until last May's upheaval, the de Gaulle government—the industry's best customer—had lavished upon itself the paraphernalia of grandeur. Since then, with its own substantial wage bill up sharply and the franc under pressure, the government has twice had to pare its spending plans. First, cuts were made to adjust to the aftereffects of the May-June strikes. A second round of cutbacks came with the austerity package de Gaulle rammed through in late November to reinforce his surprise decision not to devalue the franc.

Thus the industry must count heavily on the private sector for its 1969 growth. And the very conditions that have turned public officials into centime pinchers could make big spenders out of industrialists; each time the government has pared

its own spending, it has tucked capital-investment incentives into the budgetary package.

And although the November austerity measures included new taxes to brake consumer buying—among them higher sales taxes on radios and tv sets—there's no telling yet how well they'll work. As long as the franc seems threatened, there's the risk of a "dis-saving" splurge, with consumers converting bank savings into goods as a hedge of sorts against inflation. And austerity may not wear well with the country's testy students and workers, who can turn the country topsy-turvy.

At a time when market seers are barricading themselves behind hedges—it's hard to find anybody these days who doesn't think de Gaulle will have to devalue sooner or later—Electronics magazine forecasts an electronics market of \$1.37 billion—not including components—for 1969.

The prediction is based on market information gathered before the November devaluation crisis and the gain of 10% it represents will seem high to many. The industry's trade association, Fédération Nationale des Industries Electroniques (FNEI) pegs the rise at 8%. That would make 1969 the slowest year since the early 1950's as a good 4% of next year's sales increase will come from price inflation and not real growth.

It would take at least a catastrophe, most marketing men feel, to check the surge of computer

**New beat.** Paris police keep auto-registration files and stolen-car records in a Bull-GE 425 computer. Traffic division also analyzes vehicle-flow patterns using the system.





## French electronics market forecasts

(millions of dollars)

	1968	1969
<b>Assembled equipment, total</b>	<b>1,239.9</b>	<b>1,366.7</b>
Consumer products	347.0	378.5
Medical equipment	27.8	32.7
Communications	338.9	348.8
Computers and related equipment	266.5	324.6
Nuclear instruments and equipment	23.0	22.6
Production, control and other industrial equipment	153.8	169.0
Test and measuring equipment	82.9	90.5
<b>Components</b>	<b>438.0</b>	<b>488.5</b>

sales. French manufacturing companies, always with an anxious eye on their German competitors, are hustling harder than ever to boost their productivity and thus offset the jump in wage costs. Such is the press by French businessmen to improve productivity that an executive of one computer company says, "We don't sell, they buy."

From desk-top calculators to mammoth machines, 1969 prospects are "excellent," says Diebold-France, a consulting company that specializes in computer applications. Diebold puts the number of computers currently in use in the country at 3,300. Another 1,300 machines looks a likely number for next year.

As for their value, Electronics' forecast points to a market of \$325 million for data processing equipment, a whopping 22% more than this year's estimated \$277 million. The figure could be low. The Bureau d'Informations et de Prévisions Economiques, a government-industry research organization whose fixes on the French economy generally come as close as anyone's, predicts a 29% rise in computer sales next year.

Along with an economic climate that makes for growth, computer companies on the French scene are getting a lift from the spate of publicity generated by the Plan-Calcul, the government scheme to develop a native computer industry.

Compagnie Internationale pour l'Informatique (CII), the kingpin computer maker put together under the scheme, introduced its first "French" third-generation computer at the Paris office equipment show in September. Deliveries of the machine, dubbed Iris after the Greek goddess of communications, will start late next year.

Meanwhile, CII's competitors—the threat that spawned the computer plan—will be helped by the to-do being made over U.S. domination of data processing in France—for that matter, in Western Europe. The International Business Machines Corp. holds two-thirds of the French market. Bull-GE, controlled by the General Electric Co., is number

two and trying very hard to get a 20% slice. For the next year or two, CII will be a member of the pack scrambling for the remaining 15% or so of the market. But CII figures to be the preferred supplier of the government. With that substantial edge over its competitors, it should come on fast in the early 1970's. The company's president, Jacques Maillet, hopes CII will have between 20% and 25% of the French market by 1973.

What's good for computers is, in large measure, good for industrial electronics equipment. Sales of controls and related hardware should climb 11% in 1969 to \$169 million, according to Electronics magazine's forecast. Again, the forecast may be low. Into the nostrum compounded by the government to revive the strike-stricken economy, Prime Minister Maurice Couve de Murville threw tax incentives for new plant investment. The chief one—a tax deduction equal to 10% of the cost of new equipment—will run out at the end of 1969, so there'll be an exceptionally strong push to automate next year. Another boost for plant investment is the repeal of the employer-paid payroll tax.

### Getting it retail

The urge to buy electronics could also catch on with French consumers despite the higher sales taxes—a one-fourth boost will make the tax on radios and tv sets 25%. True, workers won't be as affluent as previously thought now that the austerity wage freeze has nullified part of the 15% wage rises seemingly won last summer. But savings deposits in France are at an all-time high and the country's consumers could do what the British did last year—dip into their savings and touch off a run on consumer-goods.

Electronics' survey spots the 1969 consumer market at \$378 million, a comfortable 9% above this year's estimated level. How close this forecast comes to the mark will depend more than anything else on color television. The government-controlled broadcast network started airing color programs 14 months ago. But color sets have so far been selling almost as slowly as California burgundy.

Still to be hit is a 100,000-set year. That bench mark will be topped in 1969—barring a calamity.

### Under the rainbow

Performance of the polychrome market next year will in large measure set the tone for the components market. There'll be a slight gain in black-and-white set production, most likely, so all the components going into the color sets will represent gains for components makers. Their market next year works out to \$488 million in the consensus forecast, up 11% from this year's estimated \$438 million.

Headed up even more steeply, of course, are sales of integrated circuits. The prediction for IC's: a near-60% spurt to \$18 million from this year's \$11.5 million. And there's no slowdown in sight. One industry study plots the growth of the IC mar-



ket to \$100 million by 1972. Some \$8 million of the IC packages sold that year will go into consumer goods, but there'll be nothing much for IC producers in the entertainment market for the next year or two.

### Beating retreat

Companies that count heavily on defense business have a difficult year ahead. De Gaulle still clings to his cherished nuclear striking force, but the country's economic woes have forced him to slow the pace at which he'll acquire it. As a result, there's no growth in the offing for the military sector, which in recent years has accounted for half the electronic industry's business.

Instead of the 10% rise in spending for military hardware logged last year (previously the industry had become accustomed to annual boosts of 15% or so), there'll be an equipment outlay in 1969 just a shade higher than 1968's. If price rises are discounted, the \$2.6 billion earmarked for next year represents a 5% decline in the equipment budget.

Aimed mainly to cover sharp pay increases for

soldiers, sailors, airmen, and the men in mufti on the Defense Ministry payroll, the equipment economies hit even high-priority items. Dropped altogether, for example, was the Navy's Mandragore tactical missile, similar to the U.S. Navy's Sea Sparrow. Sunk with it was one of three missile-carrying corvettes on the French fleet's new-construction list. The budget also slates stretchouts of a half-year or more for the programs to develop nuclear-tipped strategic missiles. And there'll be delivery delays of several months on the 30 fighter-interceptors—Dassault's new F1 swept-wing, Mach 2.2 jet—that the Air Force has ordered.

France's space budget will also decline in 1969. Funds available to the space agency next year add up to \$93 million, down from \$119 million this year and from \$108 million two years ago.

Much of the cutback, though, simply reflects fiscal recognition that the launching center in French Guiana is finished. Funds for the most prestigious item on the agency's worklist—the Franco-German Symphonie experimental communications satellite—haven't been cut. A start on hardware for the project should be made next year.

## Computers, controls, communications gear pace Italian market as set makers mark time

**German Economics Minister** Karl Schiller likes to compare his country's economy to a Volkswagen. "It just runs and runs," he says. Had Schiller the same job on the far side of the Alps, a Ferrari would be more suited to his imagery. For the Italian economy has been accelerating over the past five years at a pace no other economy in the Common Market can match.

Even a Ferrari, though, can misfire now and then. The Italian economy went into this year revved up for a 5.5% expansion. But it began to sputter in the spring and by fall the government had to add more octane to the fuel mix to hold a growth rate of 5%.

The improved mix, Italian economy-watchers think, will help keep business in something like top gear next year. They feel the economy could grow as much as 6%. People in the electronics industry—television set makers excepted—aren't quarreling with this optimistic forecast. Electronics magazine's survey indicates a near-10% rise in the electronics market to \$712 million next year.

There'll be particularly strong 1969 sales of computers, industrial equipment, and solid-state components. And 1969 will see the beginning of a five-year spurt in telecommunications buying now that a formula for apportioning the revenues from data transmission lines has been worked out. The con-

sumer sector will languish, though, until the government decides on a fast color for television.

Makers of automation equipment and process controls, according to Electronics' survey, can look forward to a 16% climb in the industrial electronics market to \$84 million.

But some manufacturers figure that 1969 will

### Italian electronics market forecasts (millions of dollars)

	1968	1969
<b>Assembled equipment, total</b>	<b>649.3</b>	<b>712.5</b>
Consumer products	264.4	257.5
Medical equipment	9.8	11.0
Communications	90.2	104.6
Computers and related equipment	157.8	196.5
Nuclear instruments and equipment	9.9	10.2
Production, control and other industrial equipment	72.4	83.9
Test and measuring equipment	44.8	48.8
<b>Components</b>	<b>189.7</b>	<b>199.9</b>



be the peak year for controls, that the market will start to decline in 1970. "Process equipment and controls tend to remain a fixed percentage of total industrial investment," says Enrico Gatti, director of marketing for Honeywell SpA, "and our estimates show a distinct levelling off by 1970-71."

But new markets should offset the expected downturn in controls buying by chemical producers and the utilities. Housing construction started to pick up this year, and Italian builders have begun to install central heating and air conditioning systems in a big way. Can demand for automatic regulation equipment be far behind?

Machine-tool electronics is another market that's about to expand. Piero Pomella, a marketing engineer for Ing. C. Olivetti & Co., sees sales of numerical readouts for machine tools headed up at least 20% in 1969. Milling machines, as before, will be the market mainstay but there'll be some applications of readouts on lathes next year.

And where readouts go, numerical controls follow. This year's machine tool show in Milan, for example, featured more than 50 different machines with numerical controls and hundreds with readouts. Challenging Olivetti for this market are Ates Componenti Elettronici SpA and Officine Galileo of Italy, and a U.S. leader in the field, the General Electric Co. To hold its lead, Olivetti plans to introduce readout equipment built with integrated circuits next year.

### **No speed limit**

In contrast to the controls makers, computer manufacturers don't foresee any slowing in the pace of their market. Electronics magazine's survey puts 1969 sales of data processing equipment at \$196 million, \$38 million over the 1968 total.

Many data processing seers would consider that projected 24% jump a bit short of the mark. The scheme of things as they see it: annual rises of at least 25% for the next two years and then a soaring takeoff.

Catapulting the early-1970's market, say these observers, will be government buying. As it stands now, government-run installations house only 8% of the computers in Italy, with schools and colleges accounting for another 11%. Anticipating increased government demand, all the major computer producers have opened, or plan to open, data-processing centers, where government agencies can take their problems. The purpose of these centers is really to make officials more computer-conscious.

### **Roadblock removed**

More computer-conscious than ever are Italy's telecommunications equipment producers. The squabble over control of the data-transmission lines linking computers and peripherals was surprisingly settled this spring by the Ministry of Posts and Telegraphs and the Società Italiana per l'Esercizio Telephonica (SIP). The ministry, which manages the trunk lines, will split the revenues

with SIP, the government company that runs local telephone systems throughout the country.

After the deal, SIP unleashed a pack of orders for telecommunications equipment, orders that should ensure a steadily growing market through 1972. By then, SIP will have spent at least \$322 million on hardware—most of it conventional telephone equipment—and most likely will up its investment now that it's sure of a share in data transmission revenues.

Such is the mood among telecommunications companies that Aldo Cardarelli, manager of the transmission division of the General Telephone & Electronics Corp.'s Italian subsidiary, says next year will see "the usual 12% gain." Electronics magazine sees a market even better than that. According to the survey, communications equipment sales will reach \$105 million next year, almost 15% above this year's estimated total.

Not all this spending will go for telecommunications of course. There's a plan afoot to expand Italy's airports and that means more air traffic control business. The government also intends to better the country's educational system. Because of this, Franco Migiara, a planning director with Philips SpA, expects a marked increase in purchases of closed-circuit tv, video recorders, and other audiovisual aids.

There's a modest military market as well. Selenia SpA, a company with only 2,500 employees but a whiz at radars, is supplying peripheral equipment for the massive Nadge air-defense network of the North Atlantic Treaty Organization. There are another 150 F-104 Starfighters in the works for the air force and that means avionics contracts since the planes are being built under license. And the army, most say, will remain a fairly good customer for radios, small radars, and low-light-level detection gear.

### **Around the bend**

In the components sector, the shift from conventional bits and pieces to semiconductors will continue. But there'll be only moderate growth over-all next year, according to Electronics magazine's survey. At \$200 million, the 1969 market will be up only \$10 million from this year's estimated consumption.

Semiconductor makers can count on another solid gain—from \$28 million to \$32 million. But once again, "next year" will be the watchword.

The massive new markets the industry is counting on still aren't within reach. Giuseppe Fontana, sales manager at Società Generale Semiconduttori (SGS), sees heavy use of semiconductors in the appliance and automotive fields—but two or three years from now. Color tv will be another windfall, but it won't hit Italy before then either unless there's a flip-flop in the government's policy.

SGS, all-Italian since Fairchild Semiconductor sold its one-third holding to Olivetti this fall, has a line of consumer-product integrated circuits ready for the market, but they'll most likely find



their first mass buyers in West Germany. Cut loose from Fairchild, SGS is pushing its research in IC's at the behest of Olivetti, which will pour in at least another \$1 million to back the R&D effort.

### Riding the brakes

Consumer equipment makers seem destined to spend the next 12 months watching their market dwindle and waiting for a move by the government on color tv. Electronics magazine's survey predicts a slight drop in 1969 sales to \$257 million from this year's estimated \$264 million.

Almost to a man, tv set makers say their woes can be traced to the government's decision to withhold color television from Italy until after 1970. Many marketers believe the delay is causing consumers to hold off on replacement sets.

"What is really frustrating is that the government still hasn't officially stated which system Italy will use," states Silvano Ercolani, secretary of ANIE, the industry trade association. The choice is between France's Secam and Germany's PAL, with the latter the almost-certain winner. "Every year that passes is a year lost for Italian manufacturers," Ercolani adds.

The country's set manufacturers have not been completely idle, though. Italian-made color sets turned up at the early-September radio and tv show in Milan. And there's a snippet of market for them. About 500,000 families in northern Italy—and that's where the money to buy expensive sets is—are within range of the Swiss station in Italian-speaking Lugano and the Swiss started color broadcasts in October.

## Spurt in tv sales colors it rosy for Swedish electronics industry

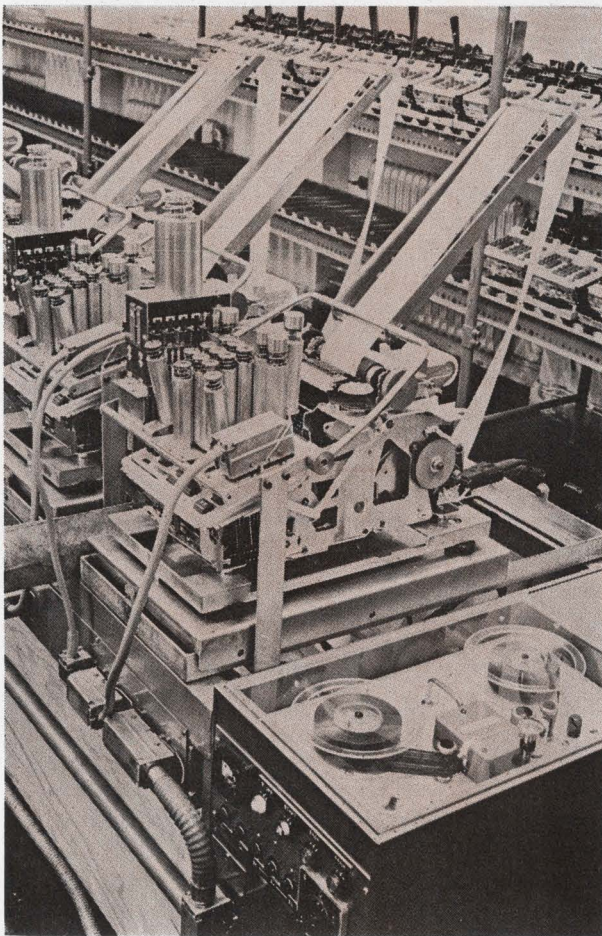

Swedish Information Service

**Drive to automate.** Swedish government's recession cures released reserves for capital investments like this tape-controlled line that checks out adding machines.

Those long northern nights won't seem so bleak this winter to Swedish electronics producers, not with the industry's prospects for 1969.

The current mood in Sweden contrasts sharply with the pessimism that prevailed a year ago. And there's little question as to the causes of this turnabout. For one thing, the Social Democratic government's recession cures have worked. For another, sales of television sets this year have been little short of spectacular.

Among the antirecession measures was the release of tax-free investment reserves the government lets companies build up in good times to counter downturns in the business cycle. These funds have helped keep sales of computers and automation equipment on the rise, and this uptrend should continue next year. And, of course, the state's traditional concern for its citizens' health bodes well for medical electronics. About the only thing Swedish electronics producers can sensibly brood about during the long winter is a flattening out of military spending.

With the growth in the over-all economy this year estimated at 3.5%—nearly twice that of 1967—and with some 52% of the country's industrial companies reporting increased order books—about double the level of a year ago—Electronics magazine's survey points to a 1969 Swedish electronics market of \$338 million, 12.5% above the estimated 1968 total.

### Clamor for color

Even that forecast may turn out to be low if there's anything next year like this year's startling spurt in consumer electronics buying.



Color television won't be officially launched in Sweden until April 1970; but the government-run network has been running test programs and viewers in southern Sweden can pick up German color broadcasts. These samplings have been enough to trigger a run on color tv receivers during the past six months. Sales topped the 25,000-set mark in October, and Jerk Harling, head of the Swedish radio-tv wholesalers' trade association, puts total 1968 volume at 40,000 sets.

Harling says there's a chance that demand will outrun dealers' supplies before the year is out. If so, the pent-up demand will help fuel the color tv market next year, a market Electronics magazine predicts will climb to about \$19 million from this year's \$17.6 million.

Black-and-white retailing isn't lagging either. After a long downtrend, sales of monochrome sets turned upward this year, rising to an estimated 180,000 sets from the 170,000 of 1967. A further gain to 200,000 is likely next year. Consumers are apparently in the process of replacing the sets they bought in the late 1950's, when television first began to catch on in Sweden. This trend will be spurred by the fact that the older receivers won't be able to pick up the nation's second channel, which the Swedish network plans to introduce in December 1969.

### A big switch?

The new tv channel will also benefit broadcast-equipment makers. Torsten Larsson, deputy director of the country's National Telecommunications Administration, says that because the channel is slated to reach 75% of the nation's viewers when it first goes on the air, the administration's budget for transmitters is being sharply increased. Totalling only \$4.5 million this year, it will rise to \$10 million next year and peak at \$13 million in 1971.

This spending will set the tone for the over-all communications market. Electronics' survey puts 1969 sales at \$89.6 million, a gain of 16% from this year's level.

The telecommunications agency may hold the key to the market's long-term prospects as well. It runs the nation's phone system and has already started trials of semielectronic switching stations. The first of them, with hardware from L.M. Ericsson, opened this fall just south of Stockholm. A second, with equipment from the administration's own factories, has since been put into service.

For the moment, there are no firm plans for a massive switch to electronics switching. But Larsson says the administration may be spending some \$20 million a year for computer-controlled telephone exchanges in the 1970's.

However, telecommunications equipment makers may have to share this pie with the administration's own factories. The ruling Social Democratic Party has interpreted its smashing election victory in September as a mandate to push state-owned industries into growth sectors of the economy and at the same time to build factories in depressed areas.

## Swedish electronics market forecasts

(millions of dollars)

	1968	1969
<b>Assembled equipment, total</b>	<b>300.5</b>	<b>338.3</b>
Consumer products	61.0	66.4
Medical equipment	15.6	16.8
Communications	77.8	89.6
Computers and related equipment	56.5	67.2
Nuclear instruments and equipment	6.8	7.7
Production, control and other industrial equipment	48.2	54.0
Test and measuring equipment	34.6	36.6
<b>Components</b>	<b>75.3</b>	<b>81.8</b>

Electronic switching thus may become largely the preserve of state factories. And the computer technology acquired in the process may open other fields to these plants.

### Doting on data

At the moment, there's no field with the growth potential of computers and their ancillary equipment. Electronics magazine forecasts a continuing climb in 1969 to \$67 million, up 19% from the estimated 1968 total.

Far-flung data transmission networks will account for much of this growth. Already in the works is a system that by 1971 will link all 550 branches of the Svenska Handelsbanken, the country's largest commercial bank. This setup, for which the Handelsbanken will buy \$10 million of hardware from Arengo Electronics AB and another \$400,000 from IBM, will link 1,100 teller terminals to a central computer and will use 6,200 miles of leased lines.

### Defense's down

Now that the Social Democrats have a strong hold on the reins of parliamentary power in Sweden, they're stepping up their campaign to pare defense spending. Over the next four years, the annual military budgets will be held between \$924 million and \$953 million, excluding adjustments for inflation. Electronics is down for \$100 million in the fiscal 1969 defense budget, but actual spending will probably come to only about \$80 million.

The big program is the Viggen S-37 attack bomber, for which Saab is the main contractor. As it stands now, the government will buy 175 of the planes, taking the first deliveries in 1971. Orders for reconnaissance and interceptor versions should come later. But the potential for growth is gone from the defense market. Ake Armgarth, a high-ranking planner in the Defense Procurement Authority, says: "Development [of the Viggen] is now well past the peak. Production will shortly reach the top and will stay there for several years."



# Philips' brass maps plans to boost computer business

What's good for Western Europe is good for Philips' Gloeilampenfabrieken. And with most European economies moving ahead nicely these days, the Giant of Eindhoven is faring quite well.

So well in fact that sales of the company's worldwide network of subsidiaries and affiliates should edge past \$2.7 billion this year. That's a 9% gain for the year, and much the same rise looks likely for 1969. If it works out that way, Philips' will come very close to qualifying for membership in the exclusive \$3-billion-a-year club.

Doing its bit for the Dutch giant will be the domestic market, pretty much a Philips preserve except for computer equipment. Electronics magazine's survey anticipates 1969 sales in the Netherlands of \$365 million, up \$31 million from the 1968 total. This growth—just under 10%—matches closely the gain predicted for the over-all economy, which is riding upward on the coattails of neighboring West Germany.

## Insider moving in

As far as computers go, the Dutch market differs little from the others in Western Europe. Next year, computers will be the fastest rising sector in electronics. According to the survey, the market for data processing equipment should jump 20% to \$68 million. And, as elsewhere on the Continent, U. S. companies will dominate the fastgrowing business.

In Eindhoven's view, fast growth in any electronics sector is good news. J.F.C. Lamet, head of commercial planning for Philips, figures that growth rates of 20% to 25% will hold for computer sales throughout Western Europe through 1971 and after that will slow to a still respectable 15% to 20%.

Trust Philips to pick up a piece of the action when it's that promising. This summer, after six years of building data processing equipment for in-house needs, the company's computer division unveiled a line of third-generation business machines. Deliveries will begin next year, the first system going to the Dutch post office.

Feeling they've now learned to walk, Philips' computer men are getting ready to sprint. F.C. Romeyn, who heads the central development bureau at Eindhoven, says Philips is working toward a "3½-generation" machine that would have processors, peripherals, and software more intimately matched than do current computers. Philips' goal is to boost its revenues from computers—now relatively insignificant—to 10% of its total sales by 1973.

The push in the computer sector is part of Philips' long-standing effort to strike a better balance between its consumer and nonconsumer offer-

ings. But it's in the consumer market that the company still finds some two-thirds of its business. And as you'd expect, Lamet and his market research crew are keeping a keen eye on color tv, the one sector in consumer electronics that seems ready to take off.

## Mass audience

The word from Eindhoven is that the color business in Western Europe started to really move this year with sales of an estimated 475,000 sets. The figure should climb next year to 1 million units, Philips estimates, and in 1970 to 1.5 million. Assuring this sort of spurt, Lamet says, is a fast improving ratio between prices and programing. Extensive color programing, he feels, is what it takes to convince consumers that a color set is worth its price—about three times as much as a black-and-white receiver. Color-set prices will remain high, but the number of hours of color broadcasting is on the rise in most countries.

For the 1969 Dutch market, Electronics' survey points to a spurt in color-set sales to \$17 million from this year's \$9 million. Along with generally good times in the country, the Dutch receiver market will get an added lift next year from a tax break. Instead of a luxury tax of 25%, sets will carry an added-value tax of 12%.

As for black-and-white sets, Lamet thinks the boom that started late last year and carried through into 1968 will taper off next year. Sales in Western Europe next year will come to about 7.5 million sets, he figures, 500,000 less than this year.

And for radios, Lamet sees a lackluster market moving up about 2% toward 19 million sets.

## Dutch electronics market forecasts (millions of dollars)

	1968	1969
<b>Assembled equipment, total</b>	<b>333.7</b>	<b>364.8</b>
Consumer products	68.9	74.7
Medical equipment	10.6	12.2
Communications	82.4	86.2
Computers and related equipment	56.1	67.6
Nuclear instruments and equipment	9.4	9.6
Production, control and other industrial equipment	57.6	62.7
Test and measuring equipment	48.7	51.8
<b>Components</b>	<b>125.9</b>	<b>134.7</b>



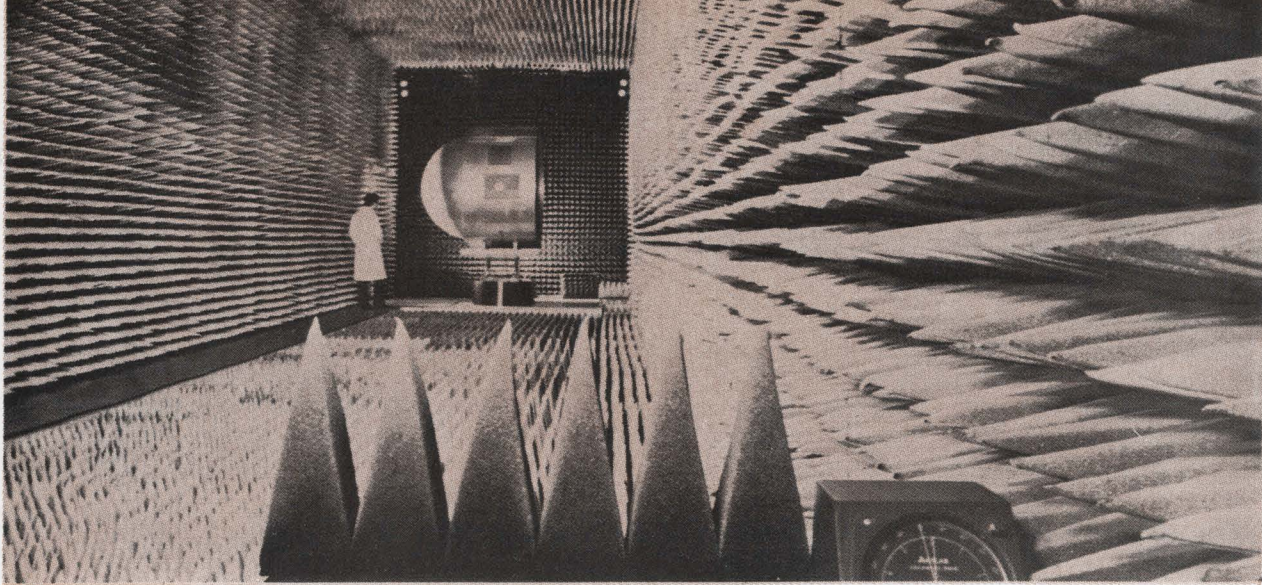

**Place in space.** International programs keep Belgian companies in space work. Here ETCA tests the satellite launched by NASA this month for the European Space Research Organization.

## Belgian business bouncing back

**This time around,** the Belgian electronics industry can look forward to more than just a change of calendars when it celebrates New Year's.

At long last, something resembling optimism is in the air. Belgium's economy expands and contracts almost in unison with West Germany's, and the dramatic German comeback has made its mark in Belgium. The prospect for 1969 is an over-all rise of 4%, enough to keep the country's smallish economy in high gear.

Whether the over-all economy is stumbling or stepping out smartly, electronics outpaces it, and there's a market of \$288 million in sight for 1969, according to Electronics magazine's consensus forecast. That's a 6% gain from the estimated \$272 million of this year.

And the forecast may be on the low side. Belgian electronics companies stand to get some new government business that will boost their output starting next year. In the works: \$60 million over the next 10 years for electronic telephone-switching equipment; some \$18 million of military hardware over a period of several years, the industry's share of offset orders for Belgian purchases of tanks and planes; and possibly \$5 million in space orders. This business will see the industry through another year of lackluster consumer buying, with black-and-white tv sales on the wane and color tv still two years away from being a significant factor.

### Right number

All things considered, the men who run the government-controlled phone systems in Europe are ultraconservatives when it comes to adopting new hardware. Most often, it's years between field trials

of equipment and full-fledged use in the system.

But Belgium's Régie des Télégraphes et Téléphones has moved with astonishing speed on electronic switching. The first two trial exchanges went into service last year; the first orders for production versions were signed late this year and more will follow early next year. Deliveries will start early in 1970, making Belgium the first country on the Continent to switch to electronic switching on a large scale. By then, the Régie expects to be ordering \$6 million of electronic exchanges yearly.

Two companies will split the business—the Bell Telephone Mfg. Co. (BTM), a subsidiary of ITT; and Automatic Electric SA, a subsidiary of the General Telephone & Electronics Corp.

### Offset orders

All three of Belgium's major electronics producers, plus a smaller company, will share the upcoming ration of new military business.

The big chunk is \$12.5 million for transceiver subassemblies, part of the hardware West Germany agreed to buy when Belgium ordered 300 of its Leopard tanks. Standard Elektrik Lorenz, a German company, is building the transceivers and, as you'd expect, has picked its sister ITT company, BTM, to supervise the job of providing components. BTM, in turn, has farmed out a \$2 million slice to Manufacture Belge de Lampes et de Matériel Electronique (MBLE), an affiliate of Philips' Gloeilampenfabrieken of the Netherlands. A further \$2.5 million of work is earmarked for Ateliers de Constructions Electriques de Charleroi (ACEC), the other member of Belgium's Big Three.

ACEC and MBLE are also in line for the \$5 million



to \$6 million that will be parceled out to the electronics industry as its share of the offset for a Belgian purchase of 88 Mirage V jets from France's Dassault. Details still have to be worked out, but the lineup looks like this: doppler radar to MBLÉ, gyro platform subsystems to ACEC, and uhf radio and test equipment to SAIT Electronics, a small company whose bread-and-butter product is marine equipment.

The Mirage V deal originally included an order for identify-friend-or-foe equipment from MBLÉ, but this contract was washed out when the U.S. government refused to grant the company a license on an American iff design. Even so, MBLÉ managing director Jacques LaGrange says he's "very satisfied" with the prospects for 1969.

### Plenty of space

Also reasonably content is Jean Paul Rasquin, assistant manager of ACEC's electronics division. The source of much of his contentment is the company's communications satellite contracts.

One, picked up by the subsidiary ACEC formed to handle space work—Etudes Techniques et Constructions Aérospatiales (ETCA)—covers \$850,000 of hardware for Intelsat 4 ground stations in Hawaii and Italy, plus some power supply systems for the satellite itself.

ETCA is a member of the Eurocan consortium, which apparently leads the race for the contract to build ground stations for the second phase of the North Atlantic Treaty Organization satellite communications system. If Eurocan does indeed win, ETCA will get a \$1.4 million order for the ground transmitters' main power supply and for the ground-station "housekeeping" system. And there's the possibility of another \$850,000 of space business if ACEC picks up the contracts it's angling for at the European Launcher Development Organization (ELDO).

BTM is also due for some space communications work. The company's parent, ITT, has subsidiaries

## Belgian electronics market forecasts (millions of dollars)

	1968	1969
<b>Assembled equipment, total</b>	<b>272.1</b>	<b>288.3</b>
Consumer products	48.2	48.9
Medical equipment	9.5	10.8
Communications	62.7	59.1
Computers and related equipment	56.6	67.2
Nuclear instruments and equipment	7.1	7.2
Production, control and other industrial equipment	60.3	64.0
Test and measuring equipment	27.7	31.1
<b>Components</b>	<b>68.5</b>	<b>72.5</b>

in all three of the consortiums competing for the second phase ground stations. For BTM then, the question isn't whether but how much. Anywhere from \$2.5 million to \$5 million says BTM's Etienne Reygaerts, who manages the radio and line transmission division.

### Cautious consumers

As the other sectors move ahead next year, the consumer market will mark time. Electronics magazine's survey puts the 1969 market at a bit under \$49 million, about the same as this year's. Many a tv set maker, however, figuring there'll be a downturn in black-and-white sales before any surge in color, would consider holding even a victory.

The color surge, most people predict, will start in 1971. The government-run broadcasting network, preparing for heavy programming, has begun building color studios. The network's equipment budget will be off by some \$10 million next year from 1968, but will climb again in 1970.

## Swiss off to fast start on color tv

**Precision timing** is a passion with the Swiss; but one of the main timetables by which their electronics industry advances has been thrown out of whack, and business is running ahead of schedule.

Had the government-run tv network hewed to its plans, color broadcasts would have started in 1970. But the Alpine airwaves have already gotten their hues. This timetable change, coupled with a generally strong expansion of the Swiss economy, should keep the electronics industry busy next year. Electronics magazine's survey forecasts a Swiss market of \$235 million in 1969, 8.5% higher than

this year's estimated \$216 million.

The early coming of color was a pleasant surprise to Swiss set makers, who 12 months ago thought they'd spend another year in the doldrums. Largely because neighboring West Germany had started colorcasts, and partly because of the Olympic Games, the Swiss network started limited color broadcasts last October. The result: \$4 million of color sales this year and an anticipated \$8 million next year. This gain will more than offset the slight downturn expected in sales of black-and-white sets, still the mainstay of consumer electronics. Over-all,



radio and tv set makers can expect a 1969 market of \$60 million, up \$5.8 million from 1968.

Early color is also bringing sooner-than-expected business to the broadcast equipment producers—mostly British and West German—who supply the Swiss network. The network's budget for color tv hardware will rise to \$2.3 million next year from this year's \$1.8 million. The network will also spend about \$20 million to build new color studios in Zurich and Geneva.

Instrument makers, too, will share the boon since the country's service shop will need new test equipment to handle color tv.

### Humming along

The Swiss horological industry, too, has reworked its timetable. Until late summer, it seemed to be ticking along toward an integrated-circuit wristwatch. Now it appears that some companies will go tocking off down a shortcut to tuning-fork-cum-transistor electronics watches.

The industry's Horological Electronics Center at Neuchâtel this year successfully tested prototypes of a wristwatch that uses a quartz crystal coupled with an IC oscillator and frequency divider. But now six companies plan to take over most of the work themselves for a preproduction series of 6,000 movements. And the center's director, Roger Wellinger, has quit his post.

Meanwhile, the largest producer of Swiss movements, Ebauches SA, has licensed the rights to the tuning-fork-cum-transistor movement on which the Bulova Watch Co. holds the patent. Ebauches presumably will go into the market with an improved tuning-fork design developed at the Neuchâtel center, but production looks to be another year off.

### Fast climb

Over the past year, the Swiss have turned the neat trick of pushing up their industrial output without adding to their rolls of foreign workers.

So it's no wonder that sales of computers and control gear are moving up sharply. Computer sales next year should climb at least 15% to \$47.1 million, and process controls seem headed for a gain of at least 10%.

Another sector to watch is medical electronics. Brown, Boveri & Cie., an old hand in the field, has been doing well with its 45 million-electron-volt radiation-therapy equipment. And Basel-based drug producers have prescribed doses of electronics for themselves. J.R. Geigy SA, for example, is working with Contraves AG, an aerospace firm in the Oerlikon-Bührle group. And Hoffman-LaRoche SA has taken a holding in a precision-instrument maker, Société Genevoise d'Instruments de Physique, to secure an ally for medical electronics.

## Spain will fall short of '69 growth goal in electronics sector

**Spain is fast shedding** her quixotic trappings in changing from an agricultural economy to an industrial one. But while windmills are giving way to factories, the transformation is bringing with it new targets for the country to tilt at—inflation, a trade deficit, and a slowdown in growth.

To win this modern joust, the Franco government next year will put into effect a three-year development plan aimed at promoting an economic expansion of 5.5% annually. The schedule calls for the Spanish electronics market to grow 10% each year through 1971.

But this mark won't be reached in 1969. Largely because of a sluggish consumer sector, the over-all market will rise by only \$13 million to \$188 million next year, according to Electronics magazine's survey. Credit the anticipated gain—7.5%—to fairly strong computer sales and sound telecommunications and industrial electronics markets.

### Overextended

There's little under the Iberian sun to brighten the year ahead for consumer electronics makers. Electronics' survey indicates a 1969 market of \$91 million, up a meager \$4 million from this year's estimated level. The forecast, though, very likely is on the high side; it was made before the government decided to extend through 1969 its curbs on consumer spending, originally scheduled to end this year.

Despite the sad shape of their market, television and radio set makers kept their production lines going full blast during the first half of this year,

**Swiss electronics market forecasts**  
(millions of dollars)

	1968	1969
<b>Assembled equipment, total</b>	<b>216.3</b>	<b>235.0</b>
Consumer products	54.2	60.0
Medical equipment	7.0	7.7
Communications	64.3	66.2
Computers and related equipment	40.8	47.1
Nuclear instruments and equipment	3.2	3.4
Production, control and other industrial equipment	34.7	37.2
Test and measuring equipment	12.1	13.4
<b>Components</b>	<b>57.0</b>	<b>61.7</b>



so a large inventory gluts the market. And to make things worse, consumer credit is under a strain. Set makers are carrying millions of pesetas in accounts receivable and some may not be able to stand up under this financial load. Even the larger companies among the 45 producing tv sets in Spain will feel the pinch.

Color tv is years off (still to be decided is the system to use—France's Secam or West Germany's PAL) so there's no lift in sight there. About the only help—and it's slight—set makers can look forward to is a deal that will send \$5 million worth of tv receivers to Colombia.

#### According to plan

While the tv-set set frets, Spanish computer and communications equipment firms should do fairly well in 1969. The computer market indicated by Electronics' survey is some \$28 million, a gain of 11% from this year.

Most of the business will go to IBM. The company never has been loquacious about its market plans anywhere, but its sumptuous headquarters on Madrid's chic Castellana is testimony to its Iberian aspirations. Of the 400 digital computers in Spain, says a well-placed source, 278 are IBM machines. Another 28 carry the trademark of Bull-GE, the French producer controlled by the General Electric Co. The remainder are from Honeywell Inc., the National Cash Register Co., the Univac division of Sperry Rand, and West Germany's Siemens AG. The Friden division of Singer-General Precision Inc. will be added to the list next year.

The Franco government's new economic plan earmarks a whopping \$1 billion for expansion of the country's communications network and that's good news for Standard Eléctrica SA, an ITT subsidiary and the largest telecommunications-hardware producer in Spain. Most of the money—some \$970 million—will go for the telephone system. And partly because of the huge government outlay in sight, Standard plans to build a new \$4 million

facility for its Madrid telecommunications Lab.

There's space money, too, in the plan. The government has directly budgeted \$23.6 million for satellite communications, but there'll be additional funds from the national telephone company.

As for military outlays, they are in a state of suspended animation; what they'll be depends on the kind of settlement the U.S. makes with Spain regarding its military bases there.

## Denmark's drive to industrialize lifts electronics

**Danish electronics** will have a lot more going for it in 1969 than it's had for a long time.

There's a new crew of Danes at the reins of government—a coalition of the Conservative, Liberal, and Radical Parties—and it's determined to get the country's finances under control. Another goal of the new government, formed this year when the Socialist regime fell, is to speed the country's transition from an agricultural economy to an industrial one.

So while clamping down on its own outlays, the government intends to spur plant investments, much to the benefit of industrial electronics firms. And the rolls of consumer electronics producers number few melancholy Danes, either. Over-all, Electronics magazine forecasts a 1969 Danish electronics market of \$139 million, up a surprisingly good 12% from this year.

#### Gamesmanship

Color tv came to Denmark in a big way this fall when the state-run Danish Broadcasting Corp. aired 80 hours of Olympic Games coverage from Mexico. The debut touched off a rush to dealers' showrooms, but most buyers went home with new black-and-white sets when they saw the \$800-to-\$1,000 retail price tags on color sets. Thus was the black-and-white market lifted out of the doldrums and some \$2.5 million worth of color sets sold, too. Next year's market for color receivers should hit \$4.5 million, according to Electronics' survey. The much larger monochrome market seems set for a 7% rise to \$16.6 million.

Computer sales, too, should surge next year. The forecast is for a market of \$29.8 million, up 15% from this year. This figure could be another \$2 million or so higher if the government moves fast on the Ministry of Education's proposal to set up computer centers at the university cities of Copenhagen and Aarhus. The proposal calls for a \$4

### Spanish electronics market forecasts (millions of dollars)

	1968	1969
<b>Assembled equipment, total</b>	<b>175.3</b>	<b>188.0</b>
Consumer products	86.9	90.9
Medical equipment	4.8	5.5
Communications	24.1	25.8
Computers and related equipment	24.9	27.8
Nuclear instruments and equipment	2.8	2.9
Production, control and other industrial equipment	26.0	28.4
Test and measuring equipment	5.8	6.7
<b>Components</b>	<b>52.9</b>	<b>57.2</b>



**Danish electronics  
market forecasts**  
(millions of dollars)

	1968	1969
<b>Assembled equipment, total</b>	<b>124.5</b>	<b>139.1</b>
Consumer products	31.1	35.5
Medical equipment	4.6	5.0
Communications	31.1	34.3
Computers and related equipment	25.8	29.8
Nuclear instruments and equipment	2.5	2.5
Production, control and other industrial equipment	22.0	24.0
Test and measuring equipment	7.4	8.0
<b>Components</b>	<b>32.0</b>	<b>34.8</b>

million outlay for data processing hardware over the next two years.

Denmark's sole computer maker, A/S Regnecentralen, will get just a miniscule piece of this market action, but that prospect hardly fazes the company's brass. Sales of Regnecentralen, soon to rename itself Scandinavian Information Processing Systems, shot up more than 50% this year to \$3.3 million; fully 90% of the business was in export markets.

The communications sector can also count on a good year in 1969. The survey indicates a 10% rise to \$34.3 million. Again, the government may make things even better. There's something like \$40 million in offset orders coming to Denmark in exchange for its purchase of 50 Draken jet fighters from Sweden. And part of these orders will go to Danish electronics producers.

## Shipshape economy buoys electronics market in Norway

The seafaring Norwegians are riding a wave of good business these days. Much of the country's livelihood comes—one way or another—from the sea. Since the Suez Canal was blocked last year, shipping around the world has boomed and the Norwegian economy is rising like a bark on a billow.

The country's electronics industry is up on the crest, too. The market next year, according to Electronics magazine's survey, will climb to \$139 mil-

lion, a 10% gain from this year's estimated \$126 million. There'll be solid gains across the board; but, as elsewhere, sales of data processing equipment will lead the way.

Norway's television set makers were presented with a broadened domestic market this year when the northern half of the country was tied into the state-run network through a broadband link. Sales this year came to about \$11.6 million and prospects are for a slight rise in 1969. Buoying the market is a government decision to let a single license fee cover all sets in a household; previously, a separate license was required for each set. And there'll be much to-do made about licenses in 1969 as the country's lawmakers decide whether or not to air commercials on tv. Also to be decided: when to commence colorcasts.

Communications equipment makers also view 1968 as a landmark year. Decca navigation transmitter chains were installed in Norway and there'll be a strong receiver market as a result. The survey forecasts a \$3 million surge in sales of navigation equipment next year to \$19 million. And, the overall communications market should rise 8% from 1968 to \$39.1 million.

As for components, the market will go from \$32.6 million this year to \$34.5 million next. The country's sole producer of integrated circuits, A/S Akers Electronics, should show added muscle in 1969. Gustav A. Ring Systemmaskiner A/S, a firm that's built a flourishing worldwide business in intercoms, plans to take Akers into its fold and make it a paying proposition. Norway's top electronics producers—Ring, Simonsen Radio A/S, and Tandbergs Radiofabrikk A/S—have managed to compete in world markets by excelling at a specialty—intercoms for Ring, acoustic fish-finders for Simonsen, tape recorders for Tandberg. Akers' niche, Ring thinks, could be custom IC's.

**Norwegian electronics  
market forecasts**  
(millions of dollars)

	1968	1969
<b>Assembled products, total</b>	<b>126.5</b>	<b>139.0</b>
Consumer products	24.4	25.6
Medical equipment	4.5	4.7
Communications	36.1	39.1
Computers and related equipment	28.2	32.7
Nuclear instruments and equipment	3.0	3.1
Production, control and other industrial equipment	21.4	23.9
Test and measuring equipment	8.9	9.9
<b>Components</b>	<b>32.6</b>	<b>34.5</b>

Reprints of this report are available at \$1 each. © Copyright 1968, Electronics © A McGraw-Hill publication



# One better comparator:

Meet our new 526 High Speed Comparator: 33% faster than any other now available (propagation delay, 42ns maximum). It operates off standard 5V logic supplies, and provides a 4V common mode range. No additional cans are required for output buffering (the 526 provides a fan-out of 10 to DTL

and TTL inputs). And the 526 is more versatile, since the differential amplifier and NAND gate can be used independently. Available now in 3 package configurations: Flat pak, TO-5 and DIPs in both military and industrial temperature ranges. Prices start at \$4.15 (100-999) for industrial DIPs.

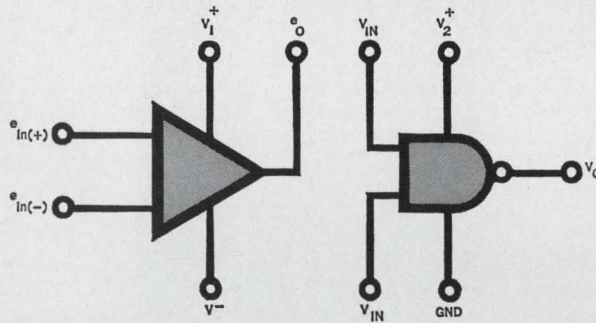

526 High Speed Comparator

# Three perfect replacements:

Signetics now has pin-for-pin and spec-for-spec replacements for the 709, 710 and 711 in all established package configurations. They are available in volume at low, low prices starting at \$1.86 (100-999) in TO-5 industrial temperature types.

5709 Operational Amplifier

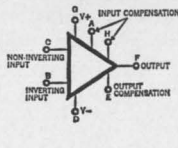

5710 High Speed Voltage Comparator

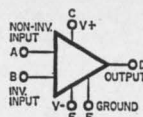

5711 High Speed Dual Voltage Comparator

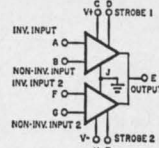

**Signetics Integrated Circuits**  
A SUBSIDIARY OF CORNING GLASS WORKS  
811 East Arques Ave., Sunnyvale, California 94086

**SIGNETICS SALES OFFICES:** Wakefield, Massachusetts (617) 245-8200; Trumbull, Connecticut (203) 268-8010; Poughkeepsie, New York (914) 471-3292; Syracuse, New York (315) 469-1072; Fort Lee, New Jersey (201) 947-9870; Radnor, Pennsylvania (215) 687-2660; Silver Spring, Maryland (301) 946-6030; Clearwater, Florida (813) 726-3734; Winter Park, Florida (305) 671-5350; Dayton, Ohio (513) 433-4133; Minneapolis, Minnesota (612) 920-3256; Rolling Meadows, Illinois (312) 259-8300; Richardson, Texas (214) 231-6344; Garden Grove, California (714) 636-4260; Burbank, California (213) 846-1020; Redwood City, California (415) 369-0333.

**DISTRIBUTORS:** Avnet Electronics Corp., Burlington, Mass. (617) 272-3060; Casco Electronics, Ltd., Montreal, Quebec, Canada (514) 735-5511. **Compar Corporation** at the following locations: Huntsville, Alabama (205) 539-8476; Los Angeles, California (213) 245-1172; Burlingame, California (415) 347-8244; Hamden, Connecticut (203) 288-9276; Clearwater, Florida (813) 446-2991; Orlando, Florida (305) 855-3964; Park Ridge, Illinois (312) 692-4125; Baltimore, Maryland (301) 484-5400; Newton Highlands, Mass. (617) 969-7140; Minneapolis, Minnesota (612) 922-7011; St. Louis, Missouri (314) 542-3399; Albany, New York (518) 489-7408; Endwell, New York (607) 723-8743; Woodbury, New York (516) 921-9385; Fairport, New York (716) 271-2230; Syracuse, New York (315) 471-3356; Winston-Salem, North Carolina (919) 723-1002; Seattle, Washington (206) 763-1711. **Hamilton Electro Sales**, Culver City, Calif. (213) 870-7171; Cherry Hill, N.J. (609) 662-9337; **Hammond Electronics**, Orlando, Florida (305) 241-6601; **Kierulff Electronics**, Seattle, Wash. (206) 763-1550; **G. S. Marshall**, San Marino, Calif. (213) 684-1530; **Milgray-Delaware Valley, Inc.**, Philadelphia, Pa. (215) 228-2000; **Pioneer Standard Electronics**, Rockville, Maryland (301) 427-3300; **Schley Electronics**, Watertown, Mass. (617) 926-0235; **Semiconductor Specialists, Inc.**, Elmhurst, Illinois (312) 279-1000; **Terminal-Hudson Electronics**, New York, New York (212) 243-5200; **Universal Electronics, Inc.**, Houston, Texas (713) 781-0421; **Wesco Electronics, Inc.**, Los Angeles, Calif. (213) 685-9525; Palo Alto, Calif. (405) 968-3475.

**DOMESTIC REPRESENTATIVES:** Compar Corporation at the following locations: Scottsdale, Arizona (602) 947-4336; Denver, Colorado (303) 781-0912; Southfield, Michigan (313) 357-5369; Haddonfield, New Jersey (609) 429-1526; Albuquerque, New Mexico (505) 265-1020; Albany, New York (518) 489-7408; Endwell, New York (607) 723-8743; Fairport, New York (716) 271-2230; Syracuse, New York (315) 471-3356; Rocky River, Ohio (216) 333-4120; Fairborn, Ohio (513) 878-2631; Dallas, Texas (214) 363-1526; Houston, Texas (713) 667-3420. **Ozark Electronic Marketing, Inc.**, St. Louis, Missouri (314) 423-7200.

**INTERNATIONAL SALES:** France, Germany, Italy, Belgium, Holland, Luxemburg, Spain—Sovcor Electronique, 11, Chemin de Ronde, Le Vesinet, (S.-&O) France. United Kingdom, Ireland, Sweden, Denmark, Norway, Switzerland, Austria, Portugal—Electrosil Ltd., Lakeside Estate, Colnbrook By Pass Slough, Buckinghamshire, Great Britain. Australia—Corning, 1202 Plaza Building, Australia Square, Sydney, N.S.W. 27-4318. Canada—Corning Glass Works of Canada Ltd., Leaside Plant, Ontario, Canada (416) 421-1500. Israel—Talviton, P.O. Box 3282, Tel-Aviv, Israel 236-666. Japan—ASAHI Glass Co., Ltd., Corning Products Sales Dept. No 14, 2-Chome Marunouchi, Chiyoda-ku, Tokyo, Japan 211-0411.



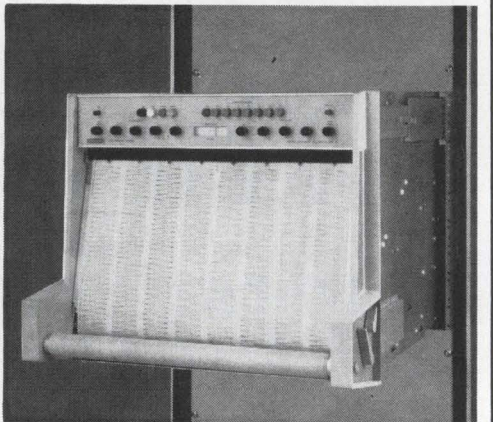
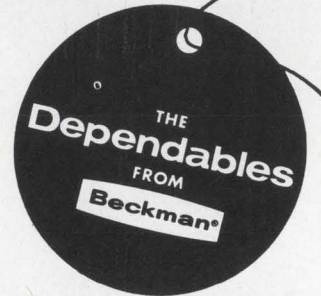
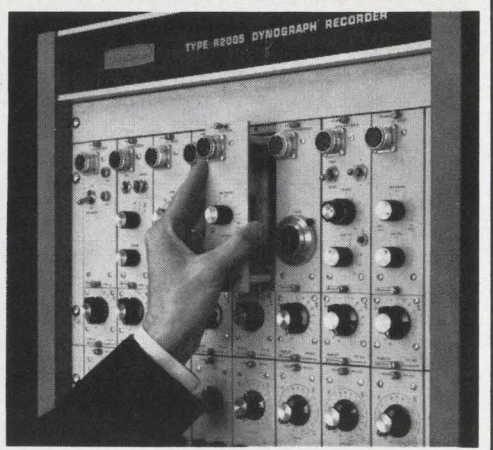
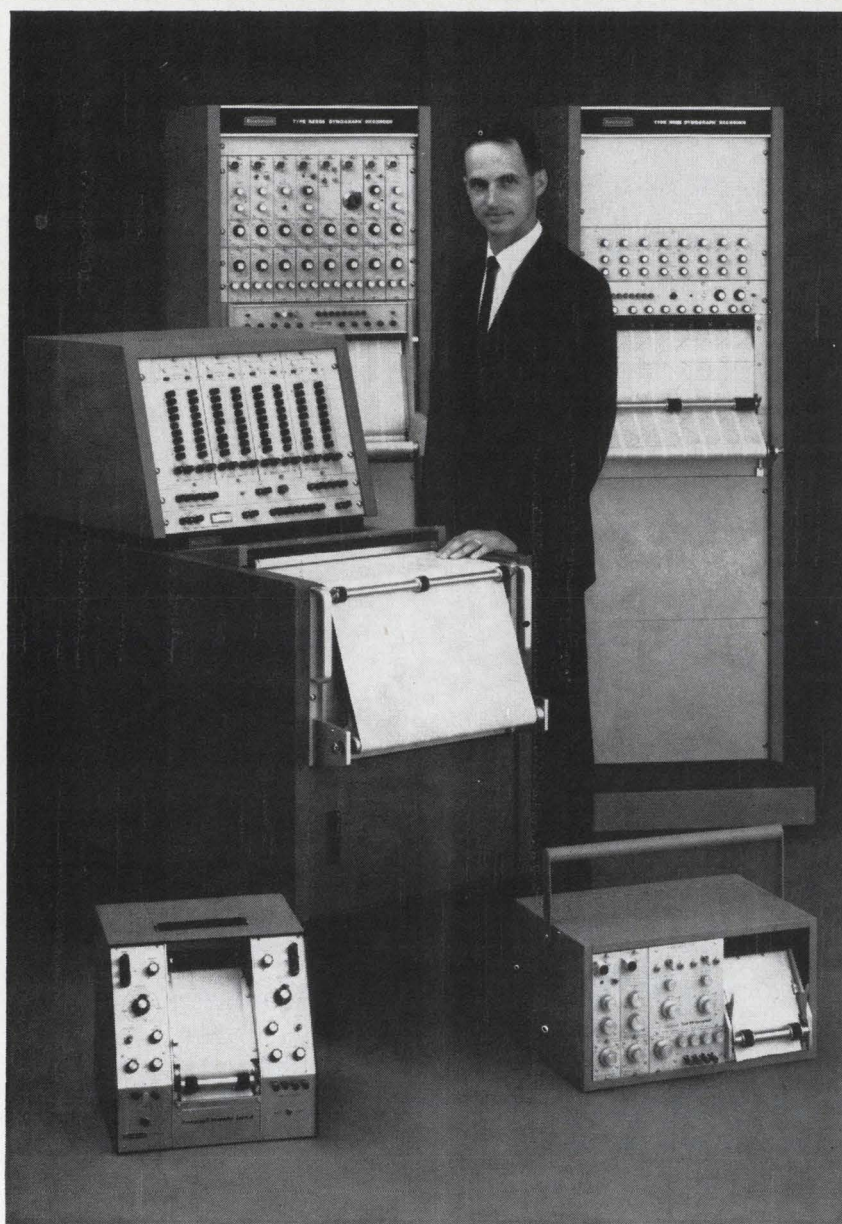

## Presenting a complete family of direct-writing recorders...

**Beckman Dynograph® Recorders.** You'll find these versatile recorders used in scientific, industrial, and educational facilities everywhere. Their application-oriented design makes them easily adaptable to your specific analog measurement requirements whether you're in aerospace, seismology, communications, transportation, oceanography...or any industry with recording needs. All are served by the complete Beckman family of *Dependable* Dynograph recorders.

You can select portable or standard Dynograph recorders... from two channels up to 24, and choose any of three writing techniques: thermal, pressurized fluid, or capillary ink. In addition, you'll get our exclusive "Zero-Weave" chart drive that automatically aligns the chart paper.

You'll also like the economy and flexibility of Dynograph recorders achieved through the use of exclusive Beckman

Input Couplers and separate preamplifiers. There is a full range of input couplers for measuring such physical or bio-physical parameters as strain, pressure, temperature, flow, velocity, etc. The preamplifiers will accept any of the couplers which eliminates the need to purchase additional preamplifiers for each application.

Dynograph recorder prices start at less than \$1,200.

For fast, expert assistance in selecting the *Dependable* Dynograph direct-writing recorder for your particular application, contact your local Beckman office, sales representative or the factory direct.

The Electronic Instruments Division develops and manufactures precision electronic measurement and test instrumentation for science and industry. Major product lines include: electronic counters, IC testers, oscillographic recorders, panel meters, system components, signal sources, time standards, and data acquisition systems.

**Beckman®**

INSTRUMENTS, INC.

ELECTRONIC INSTRUMENTS DIVISION

SCHILLER PARK, ILLINOIS • 60176

INTERNATIONAL SUBSIDIARIES: GENEVA; MUNICH; GLENROTHES, SCOTLAND; TOKYO; PARIS; CAPETOWN; LONDON; MEXICO CITY; STOCKHOLM; VIENNA



Engineers & Scientists:  
What's your line in AGM's?

# IR? RADAR? ANTI-RADIATION? CORRELATION? LASER? T.V.?

Rapid expansion of Air-to-Ground Missile activities at Hughes Aerospace Divisions in Southern California has created unusual growth opportunities for qualified Engineers and Scientists. Immediate openings exist at all levels on a variety of interesting projects such as: MAVERICK, anti-radiation missiles, radar-guided missiles and new advanced missile technologies. Areas of interest include:

Laser	Guidance	Structural Design
Radar	Aerodynamics	Warheads & Fuzing
Infrared	Signal Processing	Operations Analysis
Television	Digital Computer	Simulation Studies
Control	Thermodynamics	Trajectory Analysis

All assignments require accredited, applicable degrees, U.S. citizenship and a minimum of 3 years of related, professional experience. Please airmail your resume to:

Mr. Robert A. Martin  
Head of Employment  
Dept. 11  
Hughes Aerospace Divisions  
11940 W. Jefferson Blvd.  
Culver City, Calif. 90230

**HUGHES**  
HUGHES AIRCRAFT COMPANY  
AEROSPACE DIVISIONS  
An equal opportunity employer.



# TEKTRONIX

## Type 547 sweep-switching oscilloscope

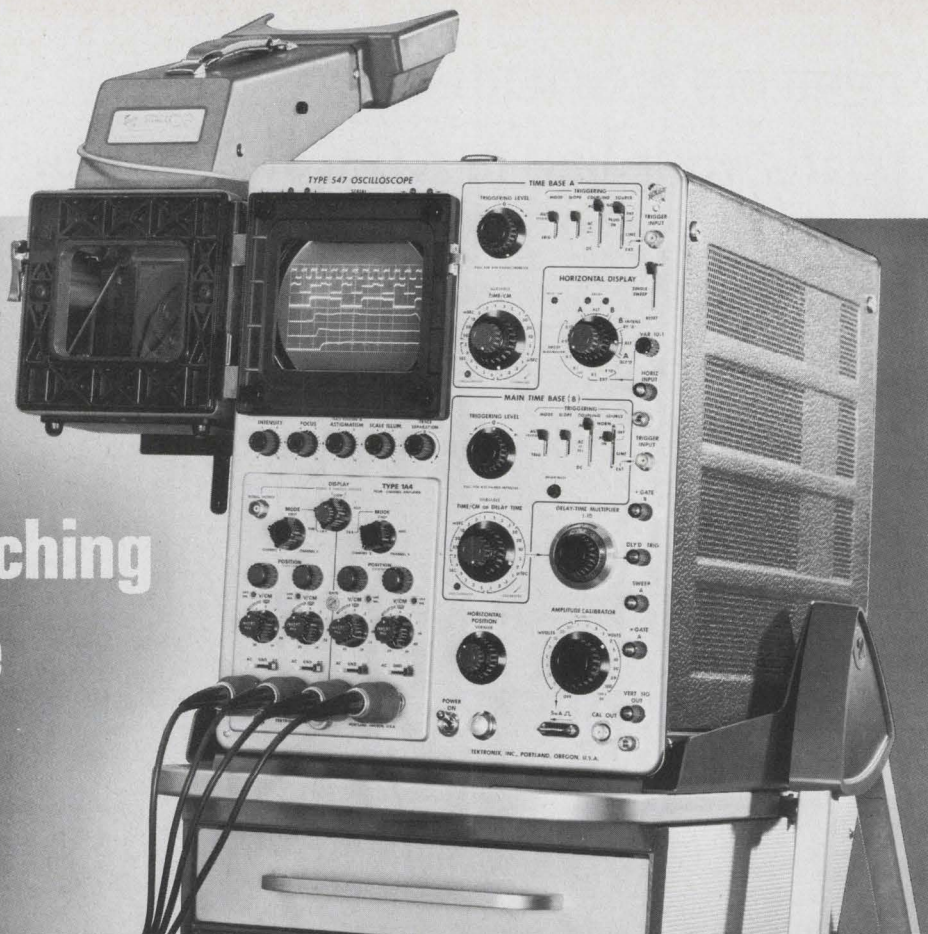

The Tektronix Type 547 is a 50-MHz, 7-ns sweep-switching oscilloscope that offers dual-beam measurement capabilities with most repetitive signals. A complete selection of plug-ins permits you to change your oscilloscope performance to meet your changing needs.

The sweep-switching feature of the Tektronix Type 547 Oscilloscope and the vertical switching of the new Type 1A4 Four-Channel plug-in provide two independent dual-trace oscilloscope systems that time-share the same CRT. The identical sweep systems provide 2% calibration from 5 s/cm to 100 ns/cm, extending to 10 ns/cm ( $\pm 5\%$ ) with the horizontal magnifier. The calibrated sweep delay range is from 100 ns to 50 s and sweep-switching provides alternate displays of the delayed and delaying sweeps.

With the Type 1A4 Four-Channel Plug-in, the Type 547 has a 7-ns risetime and DC-to-50 MHz bandwidth over its 10 mV/cm to 20 V/cm calibrated range. You can also select from 50-MHz dual-trace plug-ins, differential plug-ins with bandwidths to 50 MHz, sub-nanosecond sampling and TDR plug-ins, and four spectrum analyzer plug-ins covering the spectrum from 50 Hz to 10.5 GHz.

Type 547 Sweep-Switching Oscilloscope . . . . .	\$1875
Type 1A4 Four-Channel Plug-in . . . . .	\$ 780
Type 1S1 Sampling Plug-in . . . . .	\$1175
Type 202-2 Scope-Mobile® Cart . . . . .	\$ 135
Type C-12 Camera . . . . .	\$ 460
Type C-12 Camera Adapter (016-0226-00) . . . . .	\$ 15

U. S. Sales Prices FOB Beaverton, Oregon

### Four Signals—Two Sweeps

Using alternate vertical and horizontal display modes, Ch 1 and Ch 2 are locked to A Sweep (100 ns/cm) and Ch 3 and Ch 4 are locked to B Sweep (2  $\mu$ s/cm). This provides dual-beam measurement capabilities with most repetitive signals.

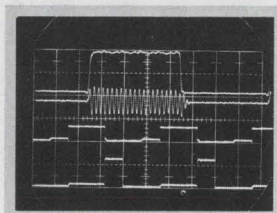

### Three Signals—Delayed Sweep

Increased convenience is provided with sweep-switching in the delayed sweep mode. You alternately view both the delaying sweep (2  $\mu$ s/cm), intensified by the delayed sweep, and the delayed sweep (100 ns/cm). With the Type 1A4 Plug-in, eight traces can be displayed.

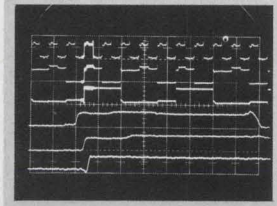

### Sampling

More measurement functions are available with the Type 547's complete selection of plug-in units. The Type 1S1 Sampling Plug-in features 0.35-ns risetime, internal triggering and up to 100 ps/cm sweep speed.

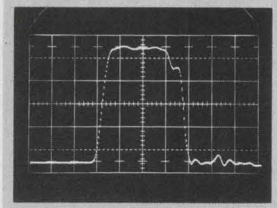

For a demonstration, contact your nearby Tektronix field engineer or write: Tektronix, Inc., P. O. Box 500, Beaverton, Oregon 97005.

## Tektronix, Inc.

*committed to progress in waveform measurement*



# Probing the News

## Advanced technology

# Microwave acoustics surfacing

The shift in emphasis from bulk to surface wave techniques that began two years ago has spurred device work, enhancing prospects for miniaturized microwave components

**Microwave acoustics** research, which until recently appeared to be at a standstill, has been gathering momentum largely because of the shift in emphasis from bulk to surface wave work during the last two years. Scientists' efforts along these lines have effectively removed the technology from the black-art category.

The decade-old field, which has a variety of other names including praeterasonics, ultrasonics, microwave hypersonics, and microsound, still has a way to go before it takes over any sizable markets. But the potential is there, along with the promise of providing miniaturized microwave components for, among other things, high-speed signal-processing diminutive high-resolution radars, portable calibration sets, and avionics systems. Technical problems still to be overcome involve materials, losses of energy both in coupling and as frequencies rise and attenuation during propagation.

Briefly, microwave acoustics involves the generation, propagation, and signal-processing of acoustic waves in, as well as along the surface of, solid materials at microwave frequencies. Sound waves travel about 100,000 times more slowly through air, solids, and liquids than do their electromagnetic counterparts. Since the physical size of a given device is related to wavelength—which is a function of the velocity of propagation and operating frequency—relatively long time delays are possible in comparatively small spaces. Microwave acoustics techniques take advantage of these phenomena, converting r-f signals into acoustic waves by means of transducers, propagating these waves through solids

or along the surfaces of substrates, and, finally, reconverting them.

It has proved all but impossible to tap, switch, or otherwise manipulate acoustical energy during transmission through bulk devices. The problem is, however, less acute in the case of surface waves; and it's in this area that most of the interesting and significant work is being done. "The physical difference between a surface and bulk wave is negligible," says Earnest Stern, assistant leader of the microwave components group at MIT's

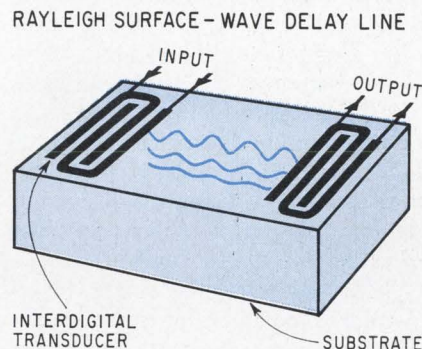

**Access.** An acoustic surface wave is potentially more useful than one of the bulk type since it can be tapped or otherwise manipulated more easily.

Lincoln Laboratory. "But the technological difference is very large indeed since the acoustic signal is available for manipulation through its entire path. The characteristics of surface waves permit the use of waveguide and related techniques formerly restricted to microwave circuits. As a result, such waveguides can transmit the acoustic signal to components that transduce, amplify, delay, and isolate."

Most researchers in the microwave acoustics field now agree with Stern: surface waves repre-

sent the best bet. A scientist at a major East Coast electronics firm sums things up this way: "Interest in surface waves soared about two years ago when Don White at Bell Labs reported his guided wave work. Prof. Eric Ash of London University was going the same route in Britain about this same time. And even before, scientists in Russia and at Berkeley were reporting about surface waves on quartz at 300 megahertz. But during the early 1960's, surface waves were mostly talk. I think everyone expected that transducers would be hard to build and that devices would be very lossy in action. However, we're now getting 12- or 13-decibel losses where we had expected 80 or 90. And the transducers haven't proven too tough."

Lt. Andrew J. Slobodnick, a research engineer at the Air Force's Cambridge Research Laboratories, goes along with the theory that surface wave devices present no particular fabrication problems. "They should be easier to produce than bulk devices what with the interdigital transducers and integrated circuit masking techniques we have at our disposal. Tolerances are admittedly tight, but the same is true of ordinary IC's and new techniques will be available when we need them," he says. "On the other hand, surface finish plays a big role in how lossy devices are going to be. This could limit the operating frequency; it's analogous to the lattice uniformity needed for low-loss propagation in bulk devices. Right now, the limits are imposed by the transducers at about 1 gigahertz. Depending on the tolerable amount of attenuation through such a device, we might be able to get up to 6 to 10 GHz—





**See-through.** Anthony van den Heuvel, a scientist at IIT Research Institute, examines an acoustic delay line in which piezoelectric thin film taps are deposited on a glass substrate.

in the lab at least—before surface fineness becomes a real limit. But things are still so unscientific that we specify surfaces as ‘free from pits and scratches’ rather than smooth to a fraction of an optical wavelength.”

**Problem area.** But on this score, Karl Wolters, manager of the applied research at Motorola’s microwave laboratory, sees potential difficulties. “A surface can be a source of damage, impurity concentrations, and other effects that affect propagation characteristics,” he says. “Efficient generation of surface waves remains a problem. In the bulk wave devices, propagation occurs in the interior where it isn’t influenced by external conditions.”

“Surface devices can do anything a bulk device can, and usually do it better,” says Anthony van den Heuvel, a scientist at the Illinois Institute of Technology Research Institute. “And the wave can be manipulated at any point—not just at the end as is the case with bulk devices. However, a source at Ling-Temco-Vought Inc., notes that bulk devices do have the advantages of lower loss and higher operating frequencies. And Walter Crofut, senior research engineer at Andersen Laboratories, says past 1 Ghz, fabrication problems become acute whereas bulk devices can now be

made rather inexpensively. Melvin G. Holland, a scientist at the Raytheon Co.’s Research division, takes issue with this pessimism. “When a device operates at the surface, it’s possible to apply IC manufacturing techniques with their promise of low-cost repeatability and producibility, and their suitability for batch processing. Surface wave devices are not the black art that bulk delay lines and their transducers continue to be,” he says.

But having agreed upon surface techniques, researchers are still confronted by difficulties. “The technical problems are similar to those encountered by the early IC makers,” says Paul H. Carr, chief of AFCRL’s microwave acoustics branch. “It could take \$500,000 to set yourself up to make microwave acoustics devices. That’s a large investment in a new technology. The big-time outfits can afford it. But what about smaller firms?”

**Search party.** Max Yoder, a long-time booster of microwave acoustics who works out of the Office of Naval Research, concedes that there’s a lot still to be learned. “Some materials are able to propagate acoustics signals at extremely high frequencies while other crystalline structures cannot,” he says. “Categories and compositions with favorable characteristics are growing steadily by empiric measurements. But the basic quest for understanding various interacting loss mechanisms continues.”

“The biggest problem is insertion loss caused either by poor coupling between the transducer and the substrate, or by losses in the substrate or transducers themselves,” says AFCRL’s Slobodnick. “Lithium niobate looks best for piezoelectric surface wave work. Electromechanical transducers on lithium niobate have been made to operate at up to 1 Ghz. We looked at quartz early in the game, but found that the coupling coefficient was pretty poor.”

Motorola’s Wolters believes the most promising materials for generating an efficient transducer are the high-electrochemical-coupling-factor piezoelectrics like lithium niobate and piezoelectric semiconducting crystals such as zinc oxide.

J. H. Collins, director of physical sciences at the Autonetics divi-

sion of the North American Rockwell Corp., nominates PZT, a piezoelectric ceramic, as an excellent possibility. “Combining PZT, which is very cheap, with a silicon epitaxial layer should permit us to make an inexpensive amplifier,” he says. “However, the propagation losses are pretty large around 1 Ghz and we have to use lithium niobate as a substrate even though it’s costly.”

### Building blocks

A number of organizations have begun putting their skills to work on devices—so far with encouraging results. At Stanford University’s microwave laboratory, for example, researchers have built what Prof. Gordon S. Kino calls “a very elegant amplifier for volume waves.” The device is made of silicon on top of a lithium niobate crystal; electrons are drifted through the silicon and a wave excited in the substrates. The parametric energy exchange provides the gain. Terminal gains of up to 30 db have been observed.

The interdigitated structure is virtually lossless. Researcher Thomas Reeder reports losses of less than 0.5 db. However, he notes, the device has a major defect because it excites waves that go in both directions along the substrate. As a result, half the power put into acoustic waves is effectively lost.

To get around this problem, Reeder and his colleagues, J. H. Collins, H. M. Girard, and H. J. Shaw, built a unidirectional transducer—two transducers, separated by a quarter wavelength; when the transducers are excited by signals of the same amplitude but separated by 90° in phase, the resultant acoustic signals add in one direction and cancel in the other. This efficiently permits propagation in one direction only.

The bandwidth of such a transducer is inversely proportional to its length, measured in interdigital periods; and since the Stanford device has two sets of 15-finger transducers, the 3-db bandwidth is very small. But, Reeder says, the lab is now experimenting with transducers only three interdigital periods long to increase the bandwidths to 10%.

**Good neighbors.** Down the road at Stanford Research Institute, re-



searchers are preoccupied with microwave filters. Alfred J. Bahr and Leo Young have built a 3-layer filter only 20 mils square and 10 microns thick. The completed sandwich consisted of layers of aluminum, cadmium sulfide (the transducer), gold, aluminum, gold, cadmium sulfide, and aluminum, on a substrate of fused quartz.

"Interdigital transducers look like the only practical method for surface wave work; their only disadvantage, other than a possible upper frequency limitation, is that they can be used only with a piezoelectric substrate," says AFCRL's Slobodnick. At the moment, however, the lab has only one working surface-wave device available—a lithium niobate delay line about 2 centimeters long and 1 cm wide. It was made by Litton-San Carlos and uses interdigital transducers, which are good up to 1 Ghz—reportedly, about three times as high as the best previous devices.

MIT's Lincoln Lab is working in several areas under Stern's direction. "Our first delay line, built last summer, used a quartz substrate; it operated at about 212 Mhz, had

a delay of about 6.5 nanoseconds, but a loss of 23 db—largely due to the quartz," says John A. Aiusow, a staffer. "Our most recent delay line uses a less lossy lithium niobate substrate and operates at 160 Mhz with a loss of only 9 db. Around 6 db of this is due to transducer loss; since the two interdigital transducers are bidirectional in their action, we automatically lose 3 db of what we put into each of them."

**Solo.** Stern's group has developed what it believes is the only cw amplifier in the microwave acoustics field. It operates at 160 Mhz, according to Aiusow, and the noise figure is 7 db.

"Our eventual goal is to get bias requirements down to the point where water cooling won't be needed," says Aiusow. "To do this we will go to a higher mobility semiconductor, cut the cross-sectional dimensions of the semiconductor layer, and finally, maximize semiconductor resistivity."

Researchers at Stanford have built a surface electroacoustic amplifier that has a net two-port terminal gain of 7 db at 108 Mhz

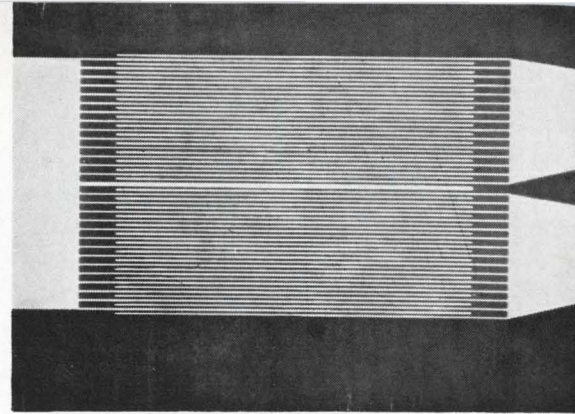

**One way.** Stanford University built this unidirectional surface wave transducer of lithium niobate.

with a delay of 9  $\mu$ sec. According to Autonetics' Collins, the device has several important advantages. For one thing, its impossible for the device to go unstable because any frequency outside the transducers' 3 db bandwidth will not be recognized. Actually, it will appear as if the transducers are not even on the substrate. Nonetheless the substrate is acoustically terminated. For another, any of these amps can serve as an isolator; as a result, microwave acoustics circuitry may not require ferrimagnetic materials.

Stanford's electroacoustical amps require about 2 kv/cm, says Collins. However, the surface sections can be segmented down the substrate and the gains added sequentially. "At Autonetics, we're now designing a device that has 35 such sections, all of which are d-c-driven in parallel," he says. Smaller sections now permit operation from a lower voltage, but there's still 2 kv/cm."

Raytheon has built transducers with 3-micron lines and has arranged to borrow a mask from Lincoln Lab with 1-micron lines and spacing. Holland is quick to point out, however, that this doesn't mean the company is having mask trouble. In fact, masks are one of Raytheon's strong points, he says. The firm's Bedford Research Lab has a D.W. Mann masking camera which can turn out transducer masks for uhf work in less than a day.

"But the Mann generator is good only for masks with nondispersive characteristics—that is, with equal spacing between transducer fingers. For dispersive devices, we must

### Surface measure

Once microwave acoustic devices are produced in respectable volume and applied in systems, conventional, commercially available test equipment will probably suffice for checkouts. But nurturing the infant technology requires somewhat exotic measurement techniques. A case in point is the low powered helium-neon laser system developed by Paul H. Carr, chief of the microwave acoustics branch, and Lt. Andrew J. Slobodnick, a research engineer, at the Air Force's Cambridge Research Laboratories to study how surface waves propagate.

"It's simplicity itself," says Slobodnick. "A millimeter-diameter laser beam is aimed at the surface of a lithium niobate delay line. By moving the beam's impact point over the surface, we can spot the physical displacements caused by surface waves propagating across the lithium niobate." Since surface waves are tiny and the laser beam is reflected along a line determined largely by the average of the surface, Slobodnick and Carr must look for the minute amount of light reflected to one side of the main beam. They find it with a photomultiplier tube; measurements of its amplitude and the angle at which it's deflected away from the main beam furnish them data which can be used to determine the location and magnitude of the surface waves, as well as check on how rapidly the waves attenuate as they propagate away from a transducer.

"Among other things, we'd like to find out whether these waves actually travel in a straight line between transducers and what the effect of surface tolerances and underlying lattice structures might be," says Carr. "We need this sort of information about substrate materials before we can optimize transducers," asserts Slobodnick.

Data on bulk wave insertion loss in various materials is now being published on a regular basis, according to Carr. He believes the same kind of information is needed for surface waves. "We can't be sure that attenuation will be the same even in the same material; we're working with a far different kind of propagation," he says.



# This new type AC regulator is all solid-state

- Sinusoidal output
- Precision RMS regulation
- Compact, modular design
- Minimum magnetic field or RFI
- Wide input range 47-440 cps
- Fast response characteristics
- Negligible no-load power
- Wide load power factor range
- High-surge power capability
- Remote sensing
- Remote voltage control
- Overload and short-circuit protected
- Automatic reset
- Wide operating temperature range
- 71°C Free air rating
- Low temperature coefficient
- Fully repairable

## STANDARD MODELS

Model	Rating	Weight	Price
RT 250	250 VA	13 lbs.	\$130.
RT 500	500 VA	17 lbs.	\$175.
RT 1000	1000 VA	22 lbs.	\$235.

## SPECIFICATIONS

**Input:** 105-130 VAC, 47-440 cps.  
**Output:** 115 VAC, nom. (see table).  
**Line Regulation (RMS):** Within  $\pm 0.1\%$  for full input change, resistive load or within  $\pm 0.2\%$  for  $+0.7$  to  $-0.7$  PF load.  
**Line Regulation (AV):** Less than  $\pm 0.7\%$  full input change and  $+0.7$  through  $-0.7$  PF load.  
**Load Regulation (RMS):** Within 0.2% for full load change, resistive, or within 0.5% for  $+0.7$  to  $-0.7$  load PF change.  
**Load Regulation (AV):** Less than 0.2% for full load change and  $+0.7$  through  $-0.7$  load PF change.  
**Frequency Regulation:** Less than 0.002% per cycle.  
**Wave Form Distortion:** Less than 5% (115 VAC input, unity through 0.7 load PF.)  
**Efficiency:** Better than 75% rated load, 115 VAC input.  
**No Load Power:** Less than 10% full load power, 115 VAC input.  
**Load Power Factors Range:**  $+0.7$  PF through  $-0.7$  PF.  
**Response Time:** Less than 16 millisecond.  
**Temperature Coefficient:** Less than 0.01%/°C.  
**Overload Protection:** Cutout at approx. twice rating.  
**Surge Output Rating:** Four times rating for 10 seconds.  
**Remote Sensing Input:** Approx. 75 mw (2.5 V @ 30 ma).  
**Operating Temperature:**  $-20^{\circ}\text{C}$  to  $71^{\circ}\text{C}$  free air, full ratings.  
**Heat Sinking:** Internal, convection cooled.

Send for Catalog #153



## ELECTRONIC RESEARCH ASSOCIATES, INC.

Dept. E-12, 67 Sand Park Road,  
 Cedar Grove, N.J. 07009  
 (201) 239-3000

Subsidiaries: ERA Electric Co./ERA Acoustics Corp.  
 ERA Dynamics Corp./ERA Pacific, Inc.

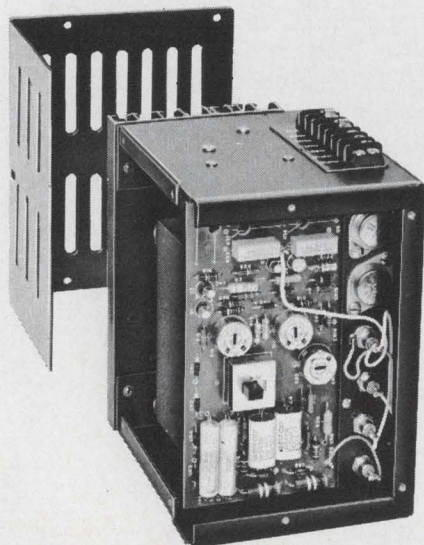

use fingers with gradually increasing, or decreasing, spacings. These masks must be created on drafting tables and photoreduced," says Holland.

**Minority reports.** Not everyone, of course, is going the surface-wave route. Andersen labs' Crofut, for example, says: "We are trying to integrate bulk-type microwave delay devices into r-f assemblies to perform a signal processing function. For example, a range-correlation device—which is a directional coupler—a delay line, and mixers all integrated on a 1-inch-square ceramic substrate, can be added to a microstrip circuit. You can get the size of bulk devices down to the point where they're compatible with microwave IC's. Of course, a lot depends on how much delay you want. For example, if you want 10  $\mu\text{sec}$ , you're stuck with 4.37 inches of sapphire; if only 100 nsec were required, the circuit could be about the same size as a transistor chip."

Teledyne Inc.'s Microwave Electronics division, an eight-year veteran in the traveling-wave-tube field, is also working the bulk side of the street. But Frank A. Olson, associate director of engineering, does not believe the acoustic amp will replace the twt. He reasons that: amplification is always accompanied by delay; there are so many collisions inside the crystal the amplifier is inefficient and presents a thermal problem which so far has confined experiments to the pulse mode (though this phenomenon does not exist for surface waves); there is transducer loss at both input and output so the noise figure is only moderately good; and the devices are prone to oscillate.

Olson recognizes surface wave techniques make analogs of microwave plumbing such as waveguides, circulators, and the like theoretically possible. But he notes such assemblies are far more lossy than the equivalent electromagnetic devices. "The designer must ask himself whether or not his system can afford this loss," he says. In any case, surface wave technology is too new to be thinking in terms of practical assemblies."

## Payoffs

Prospective applications for microwave acoustics appear limited



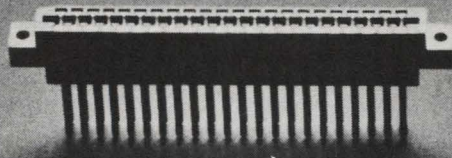

## After 17 years Sylvania breaks with custom.

You probably never knew it, but Sylvania is one of the biggest makers of precision-built circuit-board connectors. For years we have been supplying the biggest names in the computer and communications fields. But strictly on a custom basis.

Some of our custom designs have become industry standards. And now we are making them available as off-the-shelf items. This means you can now get the benefits of cus-

tom design without tooling or set-up charges.

And it means you can buy in small quantities at low prices.

You get Sylvania's special welded gold-dot contact design that puts the gold only where it's needed for low contact resistance (less than 50mV drop at 5A). And less gold means less expense.

You also get Sylvania's precision construction that puts connector terminals exactly in the right posi-

tion for programmed wiring systems.

Formats available include: 44-pin single position, 20-pin single position, 212-pin eight position, and 220-pin five position. Contact ratings up to 5 Amperes.

If these types won't fill your needs, remember we're still one of the biggest names in custom designs. Call us. Sylvania Metals & Chemicals, Parts Division, Warren, Pa. 16365.

CONNECTORS BY  
**SYLVANIA**  
A SUBSIDIARY OF  
GENERAL TELEPHONE & ELECTRONICS



# RMC

## TEMPERATURE COMPENSATING SOLDER-INS

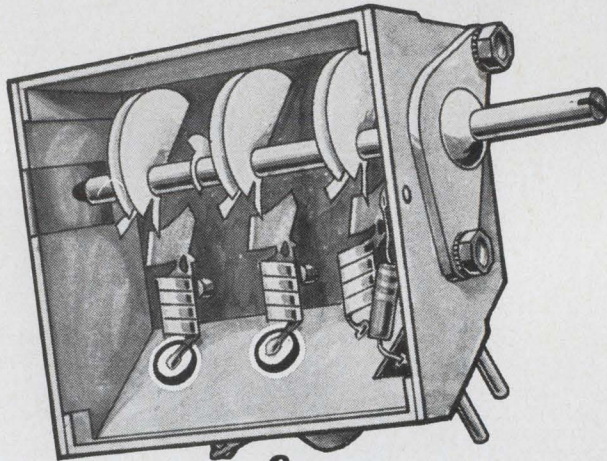

## for UHF APPLICATIONS

### SPECIFICATIONS

**CAPACITANCE:** Within tolerance @ 1 MC and 25°C

**CAPACITANCE TOLERANCES:**  $\pm 5\%$ ,  $\pm 10\%$  or  $\pm 20\%$  (but not less than  $\pm .25$  pf)

**WORKING VOLTAGE:** 500 VDC

**INSULATION RESISTANCE:** Greater than 7500 Megohms @ 500 VDC

**FLASH TEST:** 1000 VDC for 1 second

**ELECTRODE:** Pretinned for assured solderability

These new solder-in capacitors are designed for use in UHF applications requiring the absolute minimum in lead inductance effects. Solder-ins are available in a wide range of temperature coefficients in capacities from 1.5 to 105 pfd.

If your application requires special physical or electrical characteristics, contact RMC's Engineering Department.

*Write today on your company letterhead for your copy of the RMC Catalog.*

only by researchers' imaginations. "We might want to work on microwaves directly without down conversion now. Most of today's systems still do signal processing at about 60 Mhz, and suffer the noise and loss associated with mixing and down conversion," says AFCRL's Carr. "But amplification is expensive at microwave. It might prove cheaper to down-convert for signal processing. But this is going to depend on how easily devices can be mass produced and what sort of amplifiers are eventually developed."

"Microwave acoustic devices might make possible inexpensive coding of microwave (radar) signals; perhaps digital coding techniques could be used to shape the outgoing signal for best resolution, signal to noise ratio, gating, clutter reduction, and the like. Chirp is an example of such a coding technique, and we are finding that there are many such codes in theory. Another possible application area is delay lines as memories for high-speed computers."

Andersen Labs' Crofut suggests pulse compression filters, altimeters, beacon markers, and fuzing as well as ecm gear and checkout systems as possibilities. Bahr of SRI advances, among other things, acoustic microscopy and computer memory systems as prospective applications.

Thus far, work in surface waves has been limited in large part to delay-line and matched-filter applications, says IITRI's van den Heuvel. But he contends that the day is fast approaching when many conventional electronic functions will be performed in the acoustical mode. "It now appears practical—at least conceptually—to construct complete circuits and systems—receivers, transmitters, and computers—in which much, if not all, of the signal processing is performed in the acoustic or elastic mode."

To that end, IITRI researchers have been experimenting with a design for a transceiver module that would operate near 1 Ghz and be compatible with existing IC technology. The importance of this compatibility is stressed by van den Heuvel since it means the designer need not be confined solely to acoustic processing.

DISCAP  
CERAMIC  
CAPACITORS

# RMC

**RADIO MATERIALS COMPANY**

A DIVISION OF P. R. MALLORY & CO., INC.  
GENERAL OFFICE: 4242 W. Bryn Mawr Ave., Chicago 46, Ill.  
Two RMC Plants Devoted Exclusively to Ceramic Capacitors  
FACTORIES AT CHICAGO, ILL. AND ATTICA, IND.



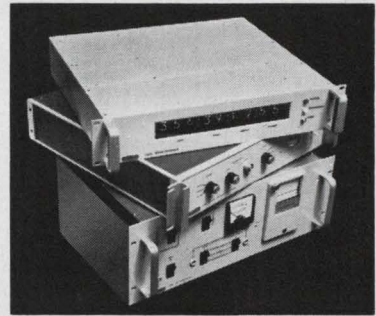
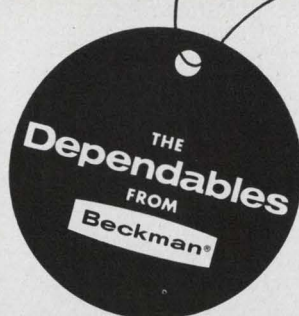
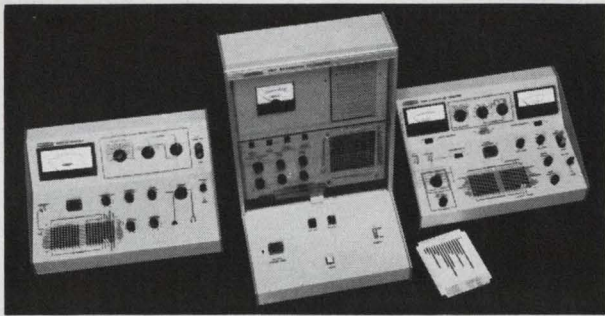

## Presenting a complete line of electronic test instrumentation

**High-Frequency IC Counter-Timers** The Beckman 6300 Series are the fastest counters made—200 MHz direct count! They are available as either six-, seven-, or eight-digit instruments with a choice of function, input and dual purpose modules to deliver all the capability needed in today's applications. And, a continuous development program lets you expand your counter/timer with added-capability modules rather than buying a new instrument.

**100 MHz EPUT and Timer** The Model 6148 is an IC unit built to accept Beckman 600 Series plug-ins. The basic instrument measures frequency, time interval, period, multiple period, ratio, multiple ratio, scaling, and counts random events. With plug-ins, you can measure frequencies to 12.4 GHz (or up to 120 GHz on request), voltages to 1000 volts, and increase input sensitivity to 1mV rms. For high resolution timing there is a 10 ns timer plug-in, ideally suiting Model 6148 for shock wave analysis, explosive burn timing, ballistics testing, time delay reflectometry, etc.

**IC Industrial Counters** In the 6200A Series, Beckman offers a complete line of 200 kHz industrial counters complete with magnetic proximity and photo electric pickups. A closed-box package design invites use under the most severe environmental conditions—dust, foreign matter, and excessive noise present no operational hazard. The series includes twelve models, from a basic accumulator to a versatile counter/timer which will measure frequency, period, time interval, ratio, and count random events all for less than \$900. The Model 6246A Dual Limit Rate Controller provides an immediate indication of whether the actual frequency rate being measured is or is not within selected limits. A 6200B Series offers added display digits and increased frequency range to as high as 10 MHz.

**IC Compatible Digital Printers** The low-cost Model 1453 is designed to operate with a variety of digital instruments and

will accept information in both 4-line BCD and 10-line decimal-code format. Local and remote red/black color control is standard. The Model 1455 is a high-speed, parallel-entry digital recorder and prints up to 12 characters a line at 20 lines per second. Provisions for local and remote input and output command signals are included to allow you to adapt the printer to various system configurations.

**IC Testers** Beckman offers integrated circuit testers designed to handle nearly all testing requirements. The Model 999 is designed for digital laboratory testing of all important dc parameters at a cost of only \$595; the Model 998 Linear IC Tester handles amplifier evaluation for \$945; and the \$3995 Model 997 Automatic Digital Tester offers economical production IC inspection, and is available with automatic IC handling capability.

**WWVB Time Standards** Three WWVB Time Code Receivers, a Decoder, a VLF Phase Comparator Receiver, and related accessories are available for receiving, decoding and displaying time code transmissions from Station WWVB, Ft. Collins, Colorado. WWVB signals are maintained within 100 milliseconds of UT-2 (Greenwich or Universal Time). The instruments are extremely simple in operation, and, in essence, add a "time" dimension to the customer's capability.

For detailed information and fast, expert assistance in selecting the *Dependable* Beckman instrument for your particular application, contact your local Beckman sales representative or the factory direct.

The Electronic Instruments Division develops and manufactures precision electronic measurement and test instrumentation for science and industry. Major product lines include: electronic counters, IC testers, oscillographic recorders, panel meters, system components, signal sources, time standards, and data acquisition systems.

**Beckman**<sup>®</sup>

INSTRUMENTS, INC.

ELECTRONIC INSTRUMENTS DIVISION

RICHMOND, CALIFORNIA • 94804

INTERNATIONAL SUBSIDIARIES: GENEVA; MUNICH; GLENROTHES, SCOTLAND; TOKYO; PARIS; CAPETOWN; LONDON; MEXICO CITY; STOCKHOLM; VIENNA





**IC METRICS, INC.**

Amplifier Types and Configurations

Parameters	SYMBOL	Amplifier Types and Configurations		
		Differential, Video, RF, General Purpose	Operational, Wide Band, IF, Audio Frequency	Audio Frequency, Video, IF, RF, Wide Band, HF, General Purpose
AC Unbalance	U	X		
Automatic Gain Control Range	AGC	X	X	X
Bandwidth	BW	X	X	X
Common-Mode Input Voltage Range	$V_{cmi}$	X	X	
Common-Mode Output Voltage	$V_{cmo}$	X		
Common Mode Rejection Ratio	$CM_{rr}$	X	X	
Common-Mode Voltage Gain	$A_c$	X		
DC Power Dissipation	$P_d$	X	X	X
Differential Input Impedance		X		
Differential Voltage Gain		X		
Input Bias Current		X	X	
Input Offset Current		X	X	
Input Offset Voltage		X	X	
Input Offset Voltage	$D_{vio}$	X	X	
Maximum Output Voltage Swing	$V_{om}$	X	X	X
Maximum Single-Ended Input Voltage	$V_{sei}$	X	X	X
Noise Figure	NF	X	X	X
Output Impedance	$Z_o$	X	X	X
Output Offset Voltage	$V_{oo}$			
Phase Margin	PHM			
Power Gain	PG			
Power Supply Rejection Ratio	$PS_{rr}$			
Quiescent Input Voltage	$V_i$			
Quiescent Output Voltage	$V_o$			
Single-Ended Input Impedance	$Z_i$			
Single Ended Voltage Gain	$A_v$			
Slew Rate	$SL_r$			
Total Harmonic Distortion	THD			
Transient Response				

**UNIQUE**

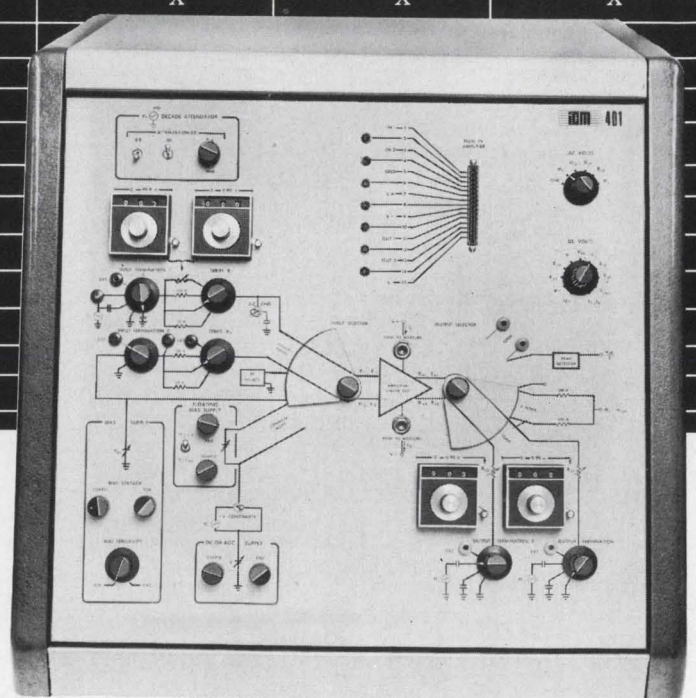

**LINEAR INTEGRATED CIRCUITS**

- REPEATABLE MEASUREMENTS
- STANDARDIZED METHOD
- Quantitative measurement of 24 Parameters
- Perform go no-go testing
- Determine performance characteristics under extra-ordinary conditions

Unique? very much so! Only IC Metrics offers a Linear Integrated Circuit Tester capable of evaluating 24 static and dynamic parameters. Model 401 can be used for all linear integrated circuits now in use and operates in conjunction with standard laboratory auxiliary equipment.

**IC METRICS, INC.**  
 121-03 Dupont Street, Plainview, L.I., N.Y. 11803  
 Representatives Inquiries Invited



# Loaded mission for ATS-F

Laser communications, direct-broadcast television, and an L-band transponder are among the 21 experiments to be carried by the satellite going up in 1972

By Paul A. Dickson

Washington regional editor

**Experiments**, recently selected for the new series of Applications Technology Satellites, shape up as proof tests for several new spacecraft, as well as new gear for operational weather and communications vehicles. Among the fields to be affected by the ATS-F and G missions are direct broadcast television, aeronautical services, and earth resources.

There will be a record 21 experiments on the 1972 ATS-F mission and as many or more aboard the ATS-G, now scheduled for a 1973 launch. The space agency plans to get the new generation of ATS vehicles off the ground with Titan 3C's, rather than Atlas-Centaurs, since larger boosters are needed to get the bigger spacecraft and their payloads into orbit. Experiments fall into six categories: pure science; spacecraft management and technology; practical space applications; meteorology; earth applications, and communications.

## View from the top

The meteorology and earth applications experiments on ATS-F involve radiometry and a camera system with very high resolution. The radiometer will contain a sensitive infrared detector and a mirror set-up that will scan the earth every nine minutes, producing pictures that will allow scientists to determine temperatures around the globe. Says Harry L. Gerwin, project manager for ATS-F and G: "Since the temperature of clouds is a function of altitude, this experiment will give us, for the first time, reliable data on cloud height, which is necessary for weather predictions." The camera system will provide 5,000-line pictures—three times the resolution of previous ATS units,

according to Gerwin.

A pair of experiments, Trust (for television relay using small terminals) and Place (for position location and aircraft communications experiment) qualify as practical space applications. The former centers on a prototype educational tv network to be set up in India. While details are still being negotiated, the basic format has been established. Television shows will originate from an Indian ground station at Amhedabad and be transmitted to the spacecraft at 8,150 megahertz. A wideband f-m signal will be returned at 850 Mhz to small, portable ground stations with 10- to 15-foot dishes for broadcast on specially built "relatively cheap" receivers.

Current plans call for the experimental system to transmit information on hygiene, birth control, farming, and other educational subjects of concern in India. Still to be resolved is the question how many sets will be available and used.

The Place experiment will employ the L-band transponder carried on the ATS-F. Aircraft will be supplying reports on their altitude to the satellite. With this data, the spacecraft will provide a fix on their location, as well as furnish a long-distance communications medium. The system has a theoretical capacity of 200 aircraft, but only a handful will be used in the actual checks [Electronics, Nov. 25, p. 65].

**Light touch.** There will be a heavy concentration of communications experiments. Long-awaited tests of laser communications will begin on ATS-F and be continued with the G version. First, there will be a series conducted with 1.6-micron lasers. For example, a laser signal will be transmitted to the

spacecraft where it will be converted to a tv signal. For the return to earth the process is reversed. The signal is sent back as a laser beam to the ground station where it is changed to a tv signal. Gerwin notes that one of the grave challenges of the experiment will be maintaining that tremendous tracking accuracy which is necessary to keep the 0.002° laser beam zeroed in on the dual targets—the spacecraft and ground station. The second phase of the experiment awaits ATS-G's launch when satellite-to-satellite laser communications will be attempted. Gerwin says that the big goal of the experiments, for the present, is measurement of the atmospheric effects relating to laser communications.

In another pair of communications experiments, ATS-F will perform as a way station for voice and data transmissions from ground stations to Nimbus satellites, Apollo Applications flights, and, of course, other ground stations. The relay system will also be used in position location experiments with other spacecraft.

A series of millimeter wave experiments will be conducted to check performance under conditions of atmospheric attenuation. Certain variables, like phase shifting, will also be examined, Gerwin says, "to get a better understanding of millimeter wave technology."

Two related communications experiments will check atmospheric effects on r-f transmissions. The first, radio-frequency interference measurement, will plot the amplitude of distortion of a 6-gigahertz signal with a 500-Mhz bandwidth sent from the ground to the satellite. In the second check, time and frequency dispersion of wideband



# Time Sharing Economy

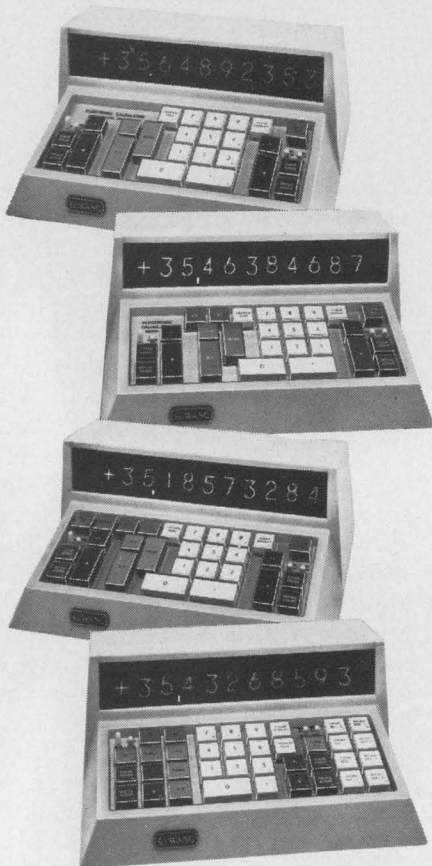

**Model 300  
Business Calculator**  
+, -, ×, ÷, reciprocals, percentages, chain multiplication, weighted averages, automatic extension, etc. Two independent adders, a product register, large readout display and automatic floating decimal point.  
**\$1070. per station\***

**Model 310  
Statistical Calculator**  
All the features and functions of the Model 300 plus  $\sqrt{x}$  and  $x^2$  by single keystroke for  $\sum x$ ,  $\sum x^2$ ,  $\sum y$ ,  $\sum y^2$ ,  $\sum (x+y)$ ,  $\sum x \cdot y$ ,  $\sum \sqrt{x}$ , and  $\sum \frac{1}{x}$   
**\$1177.50 per station\***

**Model 320  
General Purpose Calculator**  
All the features and functions of the Model 310 plus Log<sub>e</sub>x and e<sup>x</sup> by single keystroke for more advanced statistical, scientific and engineering calculations.  
**\$1282.50 per station\***

**Model 360  
Extra Storage Calculator**  
All the features and functions of the Model 320 plus four extra data storage registers for complex calculations without re-entry of intermediate results.  
**\$1497.50 per station\***

\*Four keyboards operating simultaneously from a single electronic package

## ...exclusively with Wang electronic calculators

Wang offers you more performance at less cost than any other electronic calculator available. A unique multiple-keyboard concept lets up to four operators utilize the electronic speed of its "brain" simultaneously like time-shared large computers. The "brain", in a convenient briefcase-size package, can be located anywhere up to 200 feet from the compact keyboards. You can choose any of the four models above for the most easily justified purchase you could make for efficient, dependable problem solving.



Dept. 12H, 836 North St., Tewksbury, Massachusetts 01876 • Tel. 617 851-7311

### Call today for immediate trial:

(201) 241-0250	(215) 642-4321	(309) 674-8931	(412) 366-1906	(601) 982-1721	(714) 234-5651
(203) 223-7588	(216) 333-6611	(312) 889-2254	(415) 692-0584	(602) 265-8747	(716) 381-5440
(203) 288-8481	(301) 588-3711	(313) 278-4744	(504) 729-6858	(608) 244-9261	(717) 397-3212
(205) 595-0694	(301) 821-8212	(314) 727-0256	(505) 255-9042	(615) 881-5324	(805) 962-6112
(206) 622-2466	(303) 364-7361	(317) 631-0909	(512) 454-4324	(616) 588-5731	(816) 421-0890
(212) 682-5921	(304) 344-9431	(402) 341-6042	(513) 531-2729	(616) 454-4212	(817) 834-1433
(213) 278-3232	(305) 564-3785	(404) 633-4438	(517) 835-7300	(617) 851-7311	(901) 272-7488
(214) 361-4351	(305) 841-3691	(405) 842-7882	(518) 463-8877	(702) 322-4692	(916) 489-7326
			(601) 234-7631	(703) 877-5535	(919) 288-1695
				(713) 668-0275	

## ... ATS-F has a half dozen scientific experiments ...

satellite communications, 500-Mhz bandwidth signals from 4 Ghz on down will be sent to earth from the satellite. The second test will measure the time delay of phase differential at different frequencies as they are sent to the earth. Also in the communications area, the Environmental Science Services Administration will run a radio beacon experiment.

### Innovations

ATS-F will sport a lot of new hardware. Both an improved solar cell and a gimbaled gravity-gradient boom will make their debut on the spacecraft. The latter will be controlled by an experimental three-axis star tracking calibration device.

Two new schemes for spacecraft management—Samoc (for spacecraft attitude maneuvering optimal control) and Sappsac (for self-adaptive precision pointing spacecraft attitude control)—will be checked. These complementary experiments are based on the behavior of a given satellite in orbit. Each vehicle has its own particular "character" which is discernible from data received on the ground. The experiments are designed to allow NASA to get the most out of a satellite. Says Gerwin: "We might want to maneuver the spacecraft to save fuel or cause the least valve action. These experiments will tell us how to do this with a particular satellite." Data on spacecraft performance will be telemetered to the ground where a computer after processing it will automatically generate instructions for optimum operations.

**Academic interest.** Rounding out the long list of experiments on ATS-F are a half dozen scientific projects to be conducted by universities: a low energy electron-proton experiment; measurement of low energy protons; an examination of particle acceleration mechanisms and dynamics of the outer trapping region; investigation of solar cosmic rays and geomagnetically trapped radiation; a magnetometer experiment; and an auroral particle experiment.

"The list represents the fruits of



# business trips rule out evening classes?



## here's a practical way to update your knowl- edge of electronics

Are irregular hours, travel and family obligations keeping you from attending classes—even though you worry about becoming technically obsolescent? Check into the Special Programs in Electronics for Engineers developed by CREI, the Home Study Division of the McGraw-Hill Book Company.

These are not simply courses, but comprehensive programs in advanced electronics offering major electives in such fields as:

Communications Engineering, Aeronautical and Navigational, Television Engineering, Automatic Control Engineering, Missile and Spacecraft Guidance, Radar and Sonar Engineering, Nuclear Instrumentation and Control, Computers.

Industry-recognized CREI Programs make it possible for you to catch up on new developments in electronics through study in your own home, at your own pace,

your own schedule. Free book gives complete information and details of technical material covered. For your copy, mail coupon below or write: CREI, Home Study Division, McGraw-Hill Book Company, Dept. 1848G, 3224 Sixteenth St., N.W., Washington, D.C. 20010.

Founded 1927



Accredited Member of the National Home Study Council



**CREI, Home Study Division, McGraw-Hill Book Company**  
Dept. 1848G, 3224 Sixteenth St., N.W.  
Washington, D.C. 20010

Send me free brochure describing CREI Programs in Electronics for Engineers.

NAME \_\_\_\_\_ AGE \_\_\_\_\_

ADDRESS \_\_\_\_\_

CITY \_\_\_\_\_ STATE \_\_\_\_\_ ZIP CODE \_\_\_\_\_

COMPANY \_\_\_\_\_

TITLE \_\_\_\_\_







# The many facets of a rewarding career.

Like a diamond, a career can be judged by its facets. In a diamond, it's the facets that add to the depth and luster. In a career, there are many contributing factors that make it more rewarding.

At Memorex, we can offer you a stimulating, creative environment with unsurpassed opportunity. For example, we will provide you with excellent business associates... the finest technical talent in the world. Growth... from 6 people to over 1800 in just seven years and growing faster. Outstanding reputation... quality products, backed by service. Location... the beautiful San Francisco Peninsula. And many more reasons to make your career have the proper depth.

Of course, the most important facet in making your career a success is you. What interests and motivates you? If you want more information about Memorex, write us today and while you're at it tell us something about you.

Some of current openings include:

**Electronic Maintenance Manager** BSEE preferred, with previous maintenance supervisory experience required. Will assume total department responsibility including budgeting, manpower, etc. Mechanical aptitude required, plus the ability to communicate effectively.

**Specification Engineer** Engineering degree preferred, with 2-5 years' experience in configuration control, systems development, or industrial engineering. Will devise and control product specification systems, including purchased components' specifications. Also, will participate, with Quality Control, in purchased products review and vendor approval.

**Control Systems Engineer** Requires a BSEE plus 5 years design and project management experience. Knowledge of the process industries control technology



is required. Also, prefer individual with knowledge of electrical power distribution practices. You will be responsible for the design, construction and debugging of control systems on manufacturing equipment and processes. Also, responsible for the instrument and electrical part of Engineering Division projects.

**Electronic Engineer (Senior)** Should be digital oriented with a knowledge and understanding of production equipment. BSEE required with mechanical engineering experience desired.

**Recording Specialist Engineer** Requires degree in Physics or Electrical Engineering and at least 2 years' magnetic recording experience. Duties include developing new and improved test methods, and defining equipment requirements and generate operation procedures for new tests. Also, will perform analysis of a highly technical nature, involving test instrumentation performance and validity of test results.

**Project Engineer** Challenging and rewarding opportunity for an individual with a degree in Engineering. Requires 3-5 years' experience in systems and circuit design with emphasis on analog circuits. Previous supervisory experience desired. You will work in the circuit design of process and test equipment in magnetic tape manufacturing. Previous magnetic experience is not necessary.

**Project Manager** BS in Physics or Electronics, MS preferred. Must have proven managerial skills and the ability to communicate effectively. Should have an interest in the magnetic recording or television areas.

Please send your resume to: Professional Employment Office, 1180 Shulman Avenue, Santa Clara, California 95052. An Equal Opportunity Employer.

**MEMOREX**  
CORPORATION



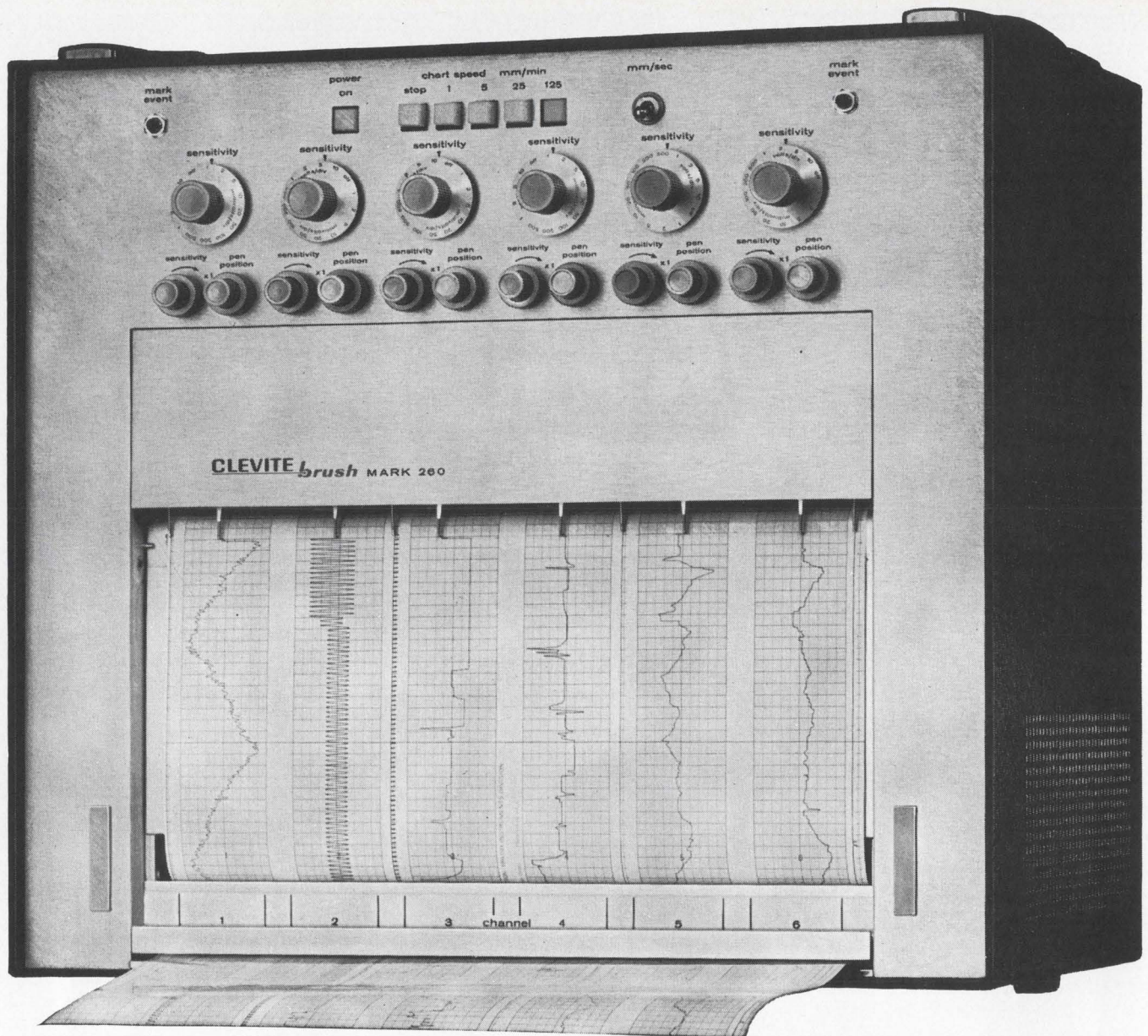

## The Mark 260 tells it like it is.

That's because we've taken the fooling out of recording. This high-performance six-channel portable delivers more fact and less fiction than any other make you can buy.

The Mark 260 eliminates the things that can fool you. First, it's accurate — better than 99.5% accurate. It's the only recorder of its type with a foolproof *position feedback* system that enforces accuracy regardless of the pen's position on the chart. Second, its resolution is fully equal to its accuracy. The Brush patented pressure-fluid writing system produces thin, sharply defined traces that cannot smudge and cannot be misread. No fooling about exact reading of point-to-point values; no fooling about even the most complex wave-forms.

And no fooling with recalibration every time you change a setting. Calibration is factory fixed, drift free and constant — no matter how often you change your mode of recording. You can be certain your data is valid . . . you save time and

chart paper. Just plug it in, set it up, and you're in business. No fooling.

Six analog channels and four event channels in a package you can carry and use anywhere.

Performance that's better than many recorders twice its size . . . and twice as expensive.

That's what the Mark 260 delivers.

More fact and less fooling.

We'd like to send you sample charts that "tell it like it is" — or better yet, demonstrate the Mark 260 right in your plant. Write Clevite Corporation, Brush Instruments Division, 37th and Perkins, Cleveland, Ohio 44114.

**CLEVITE BRUSH**





# New Products

## Semiconductors

# Fast-computer market at stake in emitter-coupled logic race

TI launches a line of 29 devices with propagation delay of 2-3 nanoseconds; Motorola will expand its MECL 3 line, aimed at the machines of the 1970's

"Any good, high-speed computer today could figure out an accurate 48-hour weather forecast. The trouble is, it would probably take 52 hours to do it."

For those in the industry, the delay in this witticism points to another kind of delay: propagation time. Saturated types of logic—TTL, DTL, and so forth—just aren't fast enough to give anyone enough warning to grab snow shovel or sunglasses. So the race has started to produce emitter-coupled logic circuits, those that can match the needs of machines even bigger and faster than today's IBM 360/85, Burroughs 8500, or Control Data 6600.

**Meet the family.** Among the newest entrants in the race are Hitachi Ltd. [Electronics, Dec. 9, p. 193] and Texas Instruments Incorporated [Sept. 16, p. 33].

TI's circuits, introduced this month and designated the ECL-2500 series, have propagation delays of 2 to 3 nanoseconds. Most will be custom-designed for specific machines, and TI calls them a "compatible catalog family" with 29 types of devices. They are "the industry's most complete high-speed family," according to TI.

In some applications, they will compete with Motorola's MECL 2 line, which operates in the 4-to-6 nsec range. Motorola's MECL 3 line has a propagation delay of 1 nsec.

"It's not really a matter of competition," says Gene McFarland of

TI, manager of ECL product marketing. He says MECL 2, the 2500 series, and MECL 3 represent "three different levels of technology."

"At these speeds, you cut propagation time in half, and another kind of technology is required," says McFarland.

Motorola has introduced three circuits in its MECL 3 line, will add 12-four gates, five flip-flops, and three adders—between now and March 15, and will have complex functions ready after mid-'69.

**Wait 'til next year.** The three full adders are 2, 4, and 8 bits. The 8-bit has 448 components or the equivalent of 88 logic gates, Motorola says. Motorola will also have, probably by next summer, a 32-gate, four-input OR/NOR array. This will be a customer-programable device with two layers of metal. The customer will specify the interconnect pattern on the second layer. Motorola also plans to include a scratchpad memory and a left-to-right shift register in MECL 3, probably late next year, but the complexity isn't defined yet.

MECL 3 is still in pilot line production, but the company says it's turning out thousands per week.

### No middlemen

In TI's family, 28 devices handle storage, interface, and both multi-function and complex logic. The other circuit is a medium-scale-integration device, an active-element

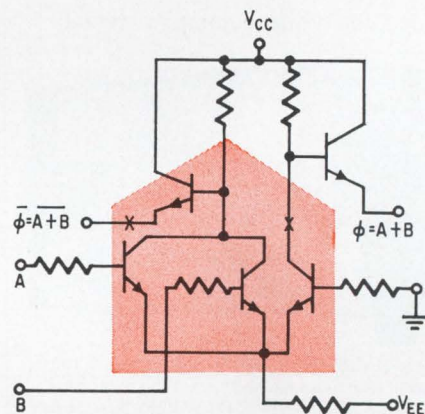

**Linkable.** Shaded area of one ECL gate can be connected to another to get wired-AND or wired-OR function.

memory in a 24-pin dual in-line package.

TI says that it can ship any of the 29 circuits in evaluation quantities but that not all are on the shelf now. Plans at this stage call for the ECL circuits to be sold direct to customers by TI, rather than through distributors. The largest single group of the new circuits involves 18 types of multifunction logic devices with 1 to 6 gates per package. They have complementary outputs, high fan-in and fan-out.

Three other logic circuits are complex, with 5 to 12 gates. They are a full adder, a 3-bit decoder, and a 4-bit group carry.

There are four types of interface devices with 2 gates per package and four storage types. A multi-







# THE OUTCLASSERS!

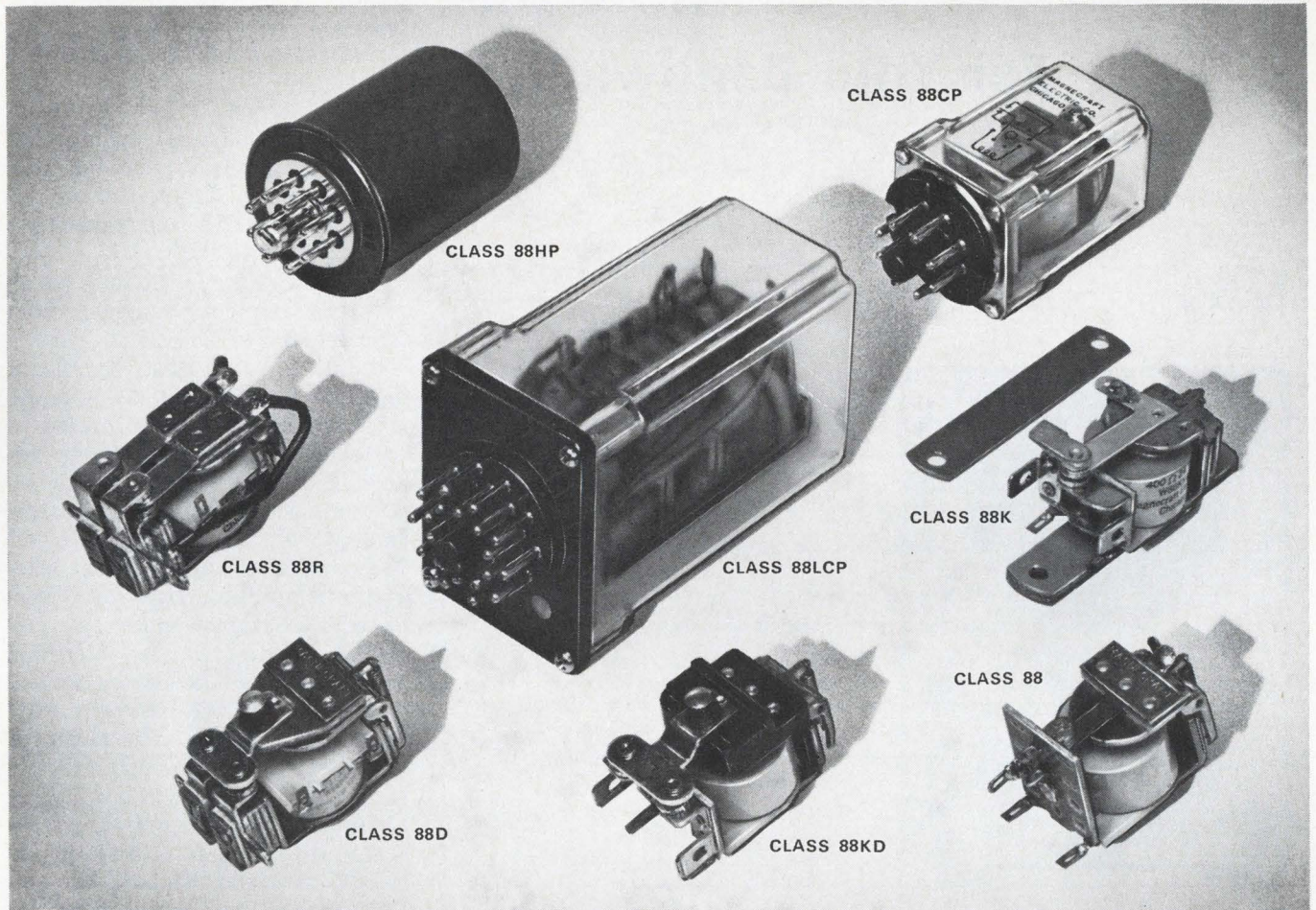

## MAGNECRAFT GENERAL PURPOSE RELAYS

Our general purpose relays aren't known as the least expensive. But they have earned the reputation for reliability with the most consistent performance record of any general purpose relay on the market.

In addition, Magnecraft has more general purpose relays in stock than anyone else. This means nearly all your requirements can be filled in days—if not hours. As for variety, we have it over the others with relays such as our improved Class 88KD 50 ampere relay that's ideal for industrial switching applications. And the new Class 88LCP Latching Relay that's composed of two Class 88 Relays with interlocking latching levers mounted on a common base and a crack-proof polycarbonate cover.

If all this doesn't overcome price alone, better forget us. But if you want large silver cadmium oxide contacts, precision hinge-pin armature bearings, molded nylon bobbins and overall custom made quality, then keep us in mind for all general purpose relays. Ours outclass the others at any price.

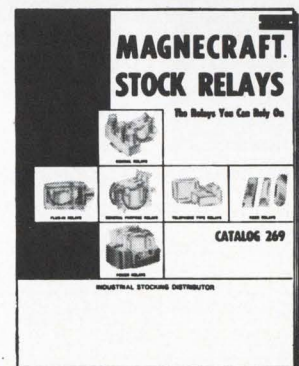

**FREE! Product File** — Yours for the asking. Contains full details on all our stock relays.

**Magnecraft**<sup>®</sup> ELECTRIC CO.

5575 NORTH LYNCH AVENUE • CHICAGO, ILLINOIS 60630 • 312 282-5500



# Is Your Budget Too Tight For Your Bandwidth?

**\$284**

○ Low Cost

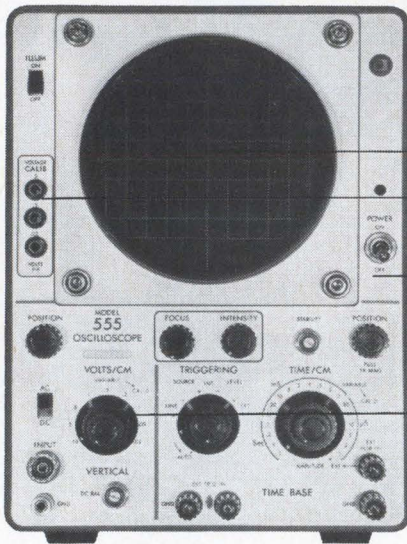

○ 8 cm x 10 cm Viewing Area

○ Voltage Calibrator

○ Solid State Reliability

○ 7 MHz Bandwidth

Try this one for size—Data Instruments Model 555. For any application, Production Line, Field or Laboratory, this scope is a perfect fit. Look at what it offers: (1) Performance. A 7 MHz bandwidth, and an extremely linear time base with variable controls over 19 calibrated ranges and a variety of triggering modes. (2) Display. A 5 inch Braun type tube with an edge lit, removable graticule provide highly precise and legible traces on an 8 x 10 centimeter viewing area. (3) Reliability. All attenuators are solid state and fully compensated. Backing up this solid state reliability is a full year's warranty and complete field and factory service.

Examine the specifications.

VERTICAL AMPLIFIER					
BANDWIDTH DC-7 MHz	SENSITIVITY/CM 20mv	ATTENUATOR 9 position	RISE TIME .05 $\mu$ s	ACCURACY $\pm$ 5%	IMPEDANCE 1M $\Omega$ + 33pf
TIME BASE			CRT	PHYSICAL	
SWEEP/CM 1 $\mu$ s-1 sec. (19 ranges)	TRIGGER 20Hz-7MHz (20mv)	HORIZONTAL AMP. Exp. X5 2Hz-200KHz	DIA. 5" (1600V)	DIM. & WT. 8" x 10.5" x 16" 22 lbs.	

Look at the scope in action. Drop us a note and we'll arrange a demonstration in your plant. You'll find the 555 fits your bandwidth requirements comfortably. At \$284 its very comfortable indeed.

Data Instruments Division • 7300 Crescent Blvd. • Pennsauken, N.J. 08110

... 0.05 to 230 Mhz range  
covered in 4 models ...

playing the output in four or five digits. Also, frequency and amplitude can be remotely programed for environmental and interference tests.

**Four models.** The generators have two oscillators, using dual-gate field effect transistors for minimum distortion. The rest of the circuitry consists of bipolar transistors and integrated circuits.

The generators in the line, which covers a frequency range of from 50 kilohertz to 230 Mhz, have a stability of  $\pm 1$  least significant digit per hour after a 5-minute warmup. The output is leveled to  $\pm 1$  decibel and is continuously adjustable from 0.1 microvolt to 1.0 volt rms across a 50-ohm resistive load (3 volts for models 920 and 930). Spurious outputs are at least 65 db below the carrier level; harmonics are down more than 30 db. The carrier can be internally amplitude-modulated at either 400 hertz or 1 khz, and externally from 20 hertz to 20 khz. The depth of modulation is continuously variable to greater than 100% at output levels up to 1 volt rms with an envelope distortion less than 1% up to 30% a-m and 3% at 70% a-m.

LogiMetrics is offering four models and a line of accessories. The 920 and 930 cover the frequency range of 50 khz to 80 Mhz. Printout capability, which allows external programing, is standard on the 930, which sells for \$4,200, and optional on the 920, priced at \$1,950.

The 940 covers from 2 to 230 Mhz with an accuracy of  $\pm 0.005\%$ , sells for \$2,350, and offers the printout capability as an optional feature. Model 910, priced at \$1,475, is a production-oriented unit that covers 100 khz to 32 Mhz. Models 910 and 920 will be available in January, the 930 and 940 in May.

Accessories will include model 360, a programable attenuator which has a 119.9-db range in 0.1 db steps, model 330 which allows automatic or manual frequency programing, and model 310, a digital frequency programer which accepts BCD-coded instructions.

LogiMetric, 100 Forest Dr., Greenvale, N.Y. 11548 [339]



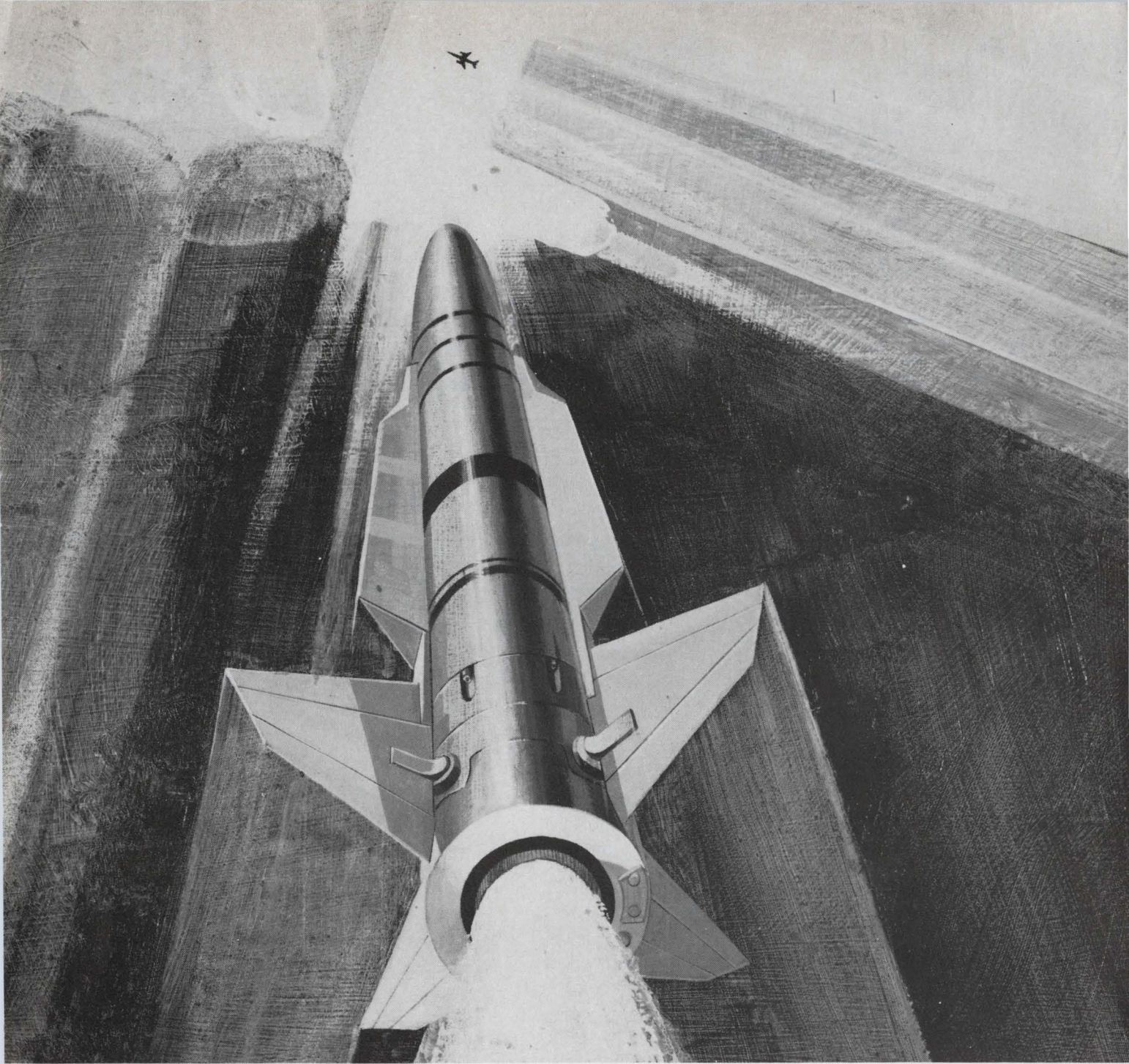

## Spot Remover.

At the Pomona division of General Dynamics engineers and scientists have developed the world's most effective spot removers. They are missiles with names like TERRIER, TARTAR, REDEYE, STANDARD MISSILE and STANDARD ARM. Developing new missiles for removing faster, smaller, more distant spots is a continuing, long-range program.

Here in Pomona, in beautiful Southern California, is the nation's leading integrated facility for the research, development, testing and manufactur-

ing of tactical guided missiles. Pomona division is close to the beaches and the mountains, and just freeway minutes from downtown Los Angeles and Hollywood. Pomona division is close to many colleges and universities and we encourage continued studies through company sponsored programs.

We have a lot to offer here for the scientist or engineer looking for a secure future in an organization that appreciates the creative mind. We both invite and reward inventiveness.

If you are thinking of a move up for

your career and your family, please send your detailed resume to:  
Mr. L. F. Cecchi,  
Manager, Engineering Personnel  
Pomona division of General Dynamics  
P. O. Box 2507-Q  
Pomona, California 91766

### **GENERAL DYNAMICS**

#### ***Pomona Division***

An Equal Opportunity Employer  
U. S. Citizenship Required



# Leave the relay driving to us!

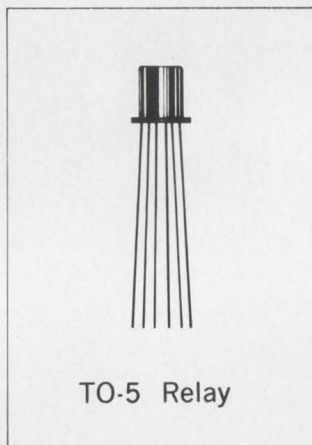

Teledyne Relays has put the Driver where it belongs — in the Driver's Seat. Neatly enclosed in the relay package, it:

- suppresses coil transients
- increases reliability
- reduces design time
- reduces relay package size more than 50%
- cuts production costs.

Don't wait! Our new T Series TO-5 Relays, with



Driver enclosed, are in full production—available off-the-shelf. Driver cost? Less than \$3. Learn how Teledyne is qualified to meet your specific relay requirements — current or future.

Send for complete data on our T Series TO-5 Relays:

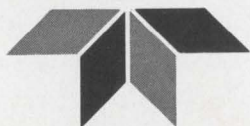

## TELEDYNE RELAYS A TELEDYNE COMPANY

3155 West El Segundo Boulevard • Hawthorne, California  
90250 Telephone: (213) 679-2205



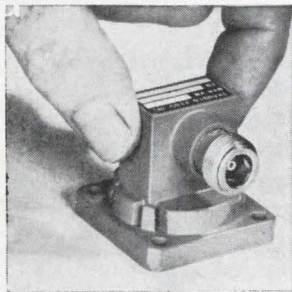

Coaxial-to-waveguide transition P/N41C00100 uses a low loss dielectric compound in the connector. This method allows a power rating  $3\frac{1}{2}$  to 4 times greater than a Teflon dielectric. Average power rating is in excess of 500 w. The unit has a vswr of 1.25 max. from 7.5 to 12 Ghz, insertion loss less than 0.25 db. Transco Products Inc., 4241 Glencoe Ave., Venice, Calif. [401]



Broadband tunnel diode detectors series D cover the 1 to 12.4 Ghz range. They come with either type N or miniature inputs and are available with maximized sensitivity over octave or multioctave bands. Prices for the type N's range from \$90 to \$120. The miniature input detectors range in price from \$100 to \$150. Electro/Data Inc., 3121 Benton St., Garland, Texas. [402]

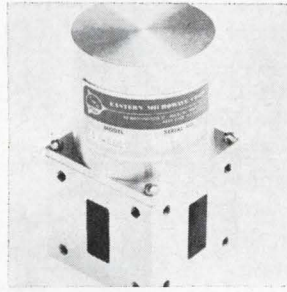

Fail-safe waveguide switch 12-1000 covers 8.2 to 12.4 Ghz. Specs include: insertion loss of 0.2 db max., isolation of 60 db typical, and a switching time of 60 msec typical. The solenoid operates on a voltage of 28 v d-c an activating current of 1.5 amps and a holding current of 0.5 amp at 26°C. Eastern Microwave Corp., 40 Washington St., Melrose, Mass. [403]

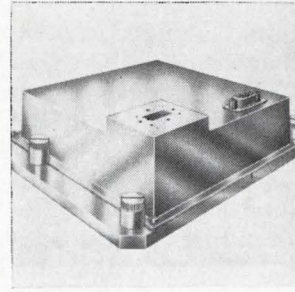

Solid state, Ku band c-w transmitter 5029-9200 is for doppler airborne navigation and beacon transmitter applications, with 0.5 w power output. It is fixed tuned for any frequency from 12 to 14 Ghz. A-m noise is 100 db below total output power at 150 hz from carrier. F-m noise is 44 hz deviation from the carrier at 100 hz. Trak Microwave Corp., Kennedy Rd., Tampa, Fla. [404]

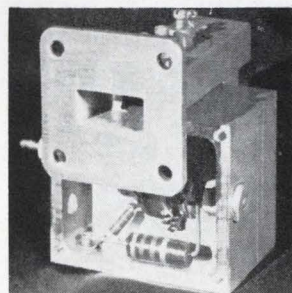

Voltage tuned frequency source model FS-48 is tunable over a 1 Ghz band in the 15 to 18 Ghz range with a 40 v tuning voltage. Power output is typically 10 mw with less than 2 db amplitude variation over the full range. Designed for airborne equipment applications, the FS-48 complies with MIL-E-5400. Frequency Sources Inc., Box 159, North Chelmsford, Mass. [405]

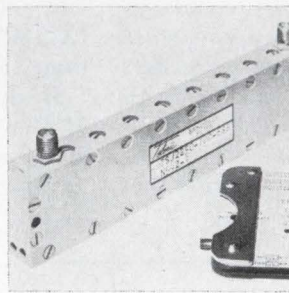

Miniature bandpass filter TSJ-2250-100-8SS is for use in the 2.2 to 2.3 Ghz telemetry band. It is of comb-line design and features insertion loss in the order of 1.5 db maximum at center frequency. Average power rating is 60 w. Operating temperature range is 0 to 50°C. Price is \$380; delivery, from stock. Telonic Engineering Co., P.O. Box 277, Laguna Beach, Calif. [406]

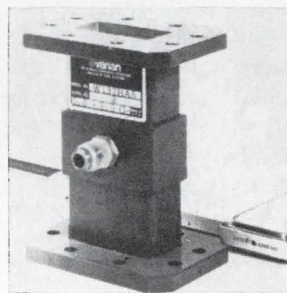

Self-resonant, half-wavelength-thick ceramic window W-137BA5 is for use as a pressure separator or an arc-impeding device with WR137 waveguide. It is suited for high-power systems operating between 5.7 and 6.5 Ghz. Weight of the unit is 1.25 lbs, length is 3.630 in., and over-all height is 2.25 in. Varian Palo Alto Tube Division, 611 Hansen Way, Palo Alto, Calif. [407]

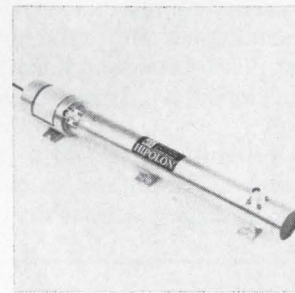

Traveling wave tube model M5650 Hipolon offers a linear dynamic range exceeding 50 db and delivers a minimum of 2 w of saturated output power. It provides 40 db minimum small signal gain at 15 db maximum noise figure across 4 to 8 Ghz. The tube features metal-ceramic construction with air cooling. Microwave Electronics, 3165 Porter Drive, Palo Alto, Calif. 94304. [408]

### New microwave

## 80-watt amplifier covers 225 to 400 Mhz

Higher-power stages of modular device are paralleled to increase reliability for radar and communications

**The first product** out of the Ampar division of the Adams-Russell Co. is really a box of new products.

The PAU-80W-29G is an 80-watt amplifier whose output is flat to within 1 decibel from 225 to 400 megahertz.

The device is built from two

modules—an 8-watt and a 40-watt amplifier. Besides being used in the 29G, the modules are being offered separately.

The amplifier is  $8\frac{1}{2}$  by 4 by  $1\frac{1}{2}$  inches, but packaging can be modified to fit the customer's needs, and the actual volume of the mod-

ules and circuitry is 16 cubic inches.

**Splits.** Input to the amplifier first passes through an 8-watt stage, the PAU-8W-17G. This module is 3 by 2 inches by 1 inch; alone, it sells for \$1,000 and has a six-week delivery time. There are four power transistors, in series, inside the module. The total gain is 18 db and the voltage standing-wave ratio into a 50-ohm load is 1.5.

The PAU-8W-17G's output can be filtered or not, depending on the application. In any event, the 8-watt signal goes to the PAU-40W-6G, a 40-watt stage whose gain is 6 db and whose vswr is 1.5 This



module is 2 by 2 inches by 1 inch and will be available in January; no price has been set.

The 40-watt output from this module feeds a 90° hybrid that splits the signal into two identical components. There's a PAU-6G-40W at each of the two output terminals of the hybrid, so both portions of the split signal are amplified. The two are then recombined in another 90° hybrid, and the output of this junction is the final 80-watt output of the amplifier.

**Three whys.** Brian McCarthy, Ampar's marketing manager, points to the broadband capability, the reliability, and the ease of repair as principal features of the new device.

According to McCarthy, most other high-power amplifiers are frequency-limited because impedance matching is done with lumped capacitances and inductances. Ampar uses broadband transformers, developed by Anzac, a sister division.

Reliability is keyed to the paralleling of amplifiers in the higher-power stages. Ampar says previous

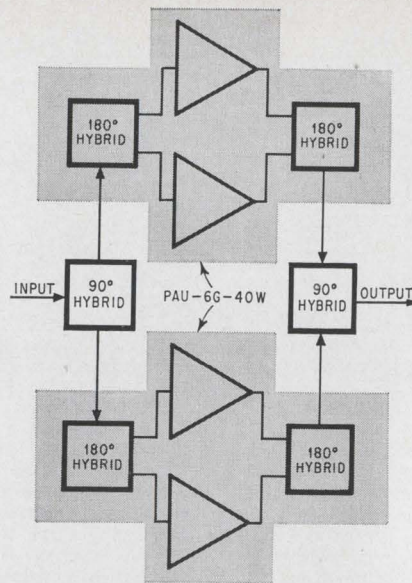

**Twin boosters.** The last stage has two 40-w modules coupled by hybrids.

attempts to use parallel techniques instead of the cascade approach in high-power microwave amplifiers were stymied by the lack of broadband power splitters and combiners. Anzac solved the problem for Ampar by developing hybrids that could do the job.

If the 8-watt input stage burns out, the whole amplifier stops working. But McCarthy says the chances of failure at this stage are small because power levels are low.

**Quick repairs.** When the 8-watt signal from this stage goes into the PAU-6G-40W, the first thing it sees is a 180° hybrid that splits the signal and sends each of the components through identical 20-watt two-transistor amplifiers. The outputs are combined in a second 180° hybrid, also part of the module. If one amplifier burns out, the other continues to run, keeping the output of the module above 50% of normal value.

Since the last stage of the PAU-80W-29G has two 40-watt modules, there are actually four 20-watt amplifiers running in parallel in this last stage. So transistor failure in any one of the four would cut the PAU-80W-29G's output by no more than 25%.

If the amplifier does fail, says McCarthy, it can be repaired in less than 10 minutes. For each of the four modules there's a go/no-go test point on the front panel of

## CTS series 750 cermet resistor networks with snap-in formed leads . . .

for either automatic insertion or hand mounting.

- Available in 4 sizes and an infinite number of circuit combinations.
- Extremely good environmental specifications.
- 5 lbs. pull strength on leads.
- Available with or without active devices.

**Delivery:** 2 weeks for prototypes; 4-6 weeks for production quantities.

**Order from:** CTS of Berne, Inc., Berne, Indiana 46711. (219) 589-3111.

### CTS CORPORATION

Founded 1896

Series 750	2-pin 1 resistor	4-pin 3 resistors	6-pin 5 resistors	8-pin 7 resistors
1,000 piece price	31.6c ea.	29.6c ea.	40.6c ea.	50.9c ea.
10,000 piece price	15.8c ea.	15.5c ea. (5.2c/ resistor)	21.0c ea. (4.2c/ resistor)	26.1c ea. (3.7c/ resistor)

These prices are based on ±5% tolerance, ±300ppm/°C standard TC, and 50 ohms thru 100K ohms resistance range with all resistance values being within a 10:1 ratio per side.

# CERMET RESISTOR



the amplifier. After determining which module failed, the user replaces the bad one and adjusts a capacitor.

The PAU-29G-80W draws 8 amps at 27 volts; impedance is 50 ohms and efficiency 45%. The user can pick a gain from 27 to 30 db.

Ampar Division, Adams-Russell Co., 39 Green St., Waltham, Mass. 02154 [409]

New microwave

## Diodes put out more milliwatts

Impatt yields 500, Gunn 120; both devices cost \$350 in Japan

**One show** of strength isn't enough for the Nippon Electric Co. It's built what it calls the most powerful impatt diode and the most powerful Gunn diode commercially

available. Both types of diodes have long been called potential signal generators in small microwave systems, such as hand-held radars and portable transponders. The main problem has been getting enough power out of them.

Nippon's new impatt diode delivers a minimum of 500 milliwatts, continuous-wave, in the 8-to-13-gigahertz range. Typical output is 700 mw and efficiency is 3% minimum.

The unit price in Japan is \$350. Nippon says it can supply a customer with one or two diodes right away; orders for up to 10 units take a month to fill, and orders for more than 10 units take three months.

Nippon doesn't expect the 500-mw record to stand for long and names Nippon as the company most likely to break it. By mounting impatt diodes on diamond chips, researchers expect to be able to boost output to 3 watts, and with two diodes mounted on the same chip they expect the output to be 5 watts.

**Big Gunn.** Delivering between 6 and 16 Ghz, Nippon's Gunn diode puts out a minimum of 120 mw

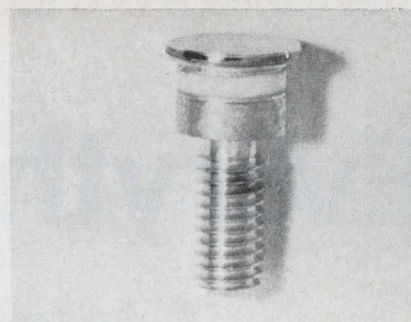

**Strongboy.** The output range of the 500-mw impatt diode is 8 to 13 Ghz.

c-w. A similar device operating between 15 and 21 Ghz can generate 90 mw. These two units also cost about \$350 in Japan.

Nippon feels that its latest Gunn diodes have gone about as far as Gunns should go. On special orders, the company can make 200-mw units, but it doesn't plan to build devices much stronger.

The company says that Gunn diodes are superior for low-noise work requiring less than 300 mw; over that level, says Nippon, impatt diodes are the answer.

Nippon Electric Co., 15, 7-5 Chome Shiba, Minato-Ku, Tokyo [410]

# NETWORKS

network or thick film hybrid circuit is mechanically compatible with standard 14 lead *dual-in-line package* . . . simplifying automatic insertion

and reducing assembly costs accordingly. The networks can also be easily hand mounted.

**Series 760 provides:**

- Up to 13 resistors per module with an infinite number of circuit combinations.
- Extremely good environmental specifications.
- 5 lbs. pull strength on leads.

**Delivery:** 2 weeks for prototypes; 4-6 weeks for production quantities.

**Order from:** CTS of Berne, Inc., Berne, Indiana 46711. (219) 589-3111.

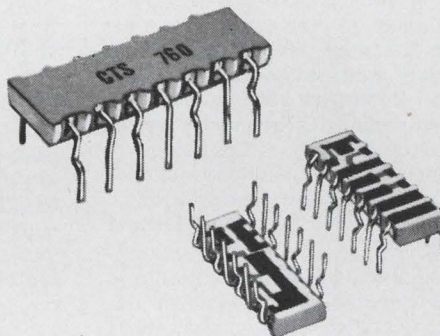

Series 760	9 resistors	11 resistors	13 resistors
1,000 piece price	82c ea.	86c ea.	90c ea.
10,000 piece price	41c ea. (4.5c/resistor)	43c ea. (4c/resistor)	45c ea. (3.5c/resistor)

Prices shown are based on  $\pm 5\%$  tolerance,  $\pm 300\text{ppm}/^\circ\text{C}$  standard TC, and 50 ohms through 100K ohms resistance range with all resistance values within a 5:1 ratio per side.

# CTS CORPORATION





# Everything but the chips

## A total packaging capability for hybrid integrated circuits

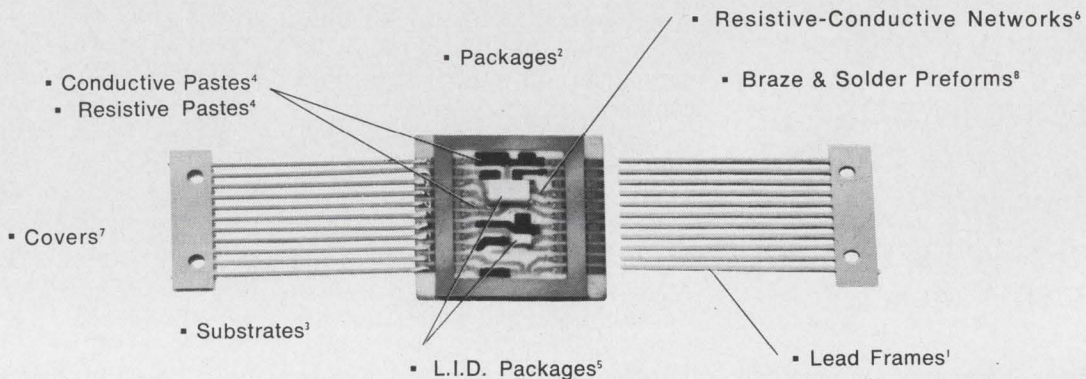

### Alles bis auf die Halbleiterbestückung

Alles von einer einzigen Bezugsquelle: Ein Anruf eines Verkaufsbüros oder Vertreters von Alloys Unlimited verschafft Ihnen Zugang zu Forschung und Entwicklung wie auch Mengenbezug von Lagerartikel oder Sondergeräte — für sämtlichen Bedarf an gedruckten Verbundschaltungen. ■ Leitrahmen ■ Aggregate ■ Grundplatten ■ Leitpasten ■ Widerstandpasten ■ Leiterlose Kontaktgeräte ■ Widerstand/Leiternetze ■ Abdeckungen ■ Vorgeformte Hartund Weichlote

Die Einzelfirmen, die zum Konzern Alloys Unlimited gehören, sind Hersteller der oben verzeichneten Bestandteile. Alloys Unlimited mit ihren Tochtergesellschaften verfügen über komplette Liefermöglichkeiten für Verbundschaltungen; eine einzige Bezugsquelle für höchste Qualität bei konkurrenzfähigen Preisen.

Man verlange unsere neue Gratis-Broschüre mit Spezifikationen, Preisen, Bestellungsangaben und Verzeichnis der Absatzstellen in aller Welt.

#### Umfassendes Herstellungsprogramm für Verbundschaltungen

Aggregate, Grundplatten, Leitpasten, Widerstandspasten, Widerstand/Leiter Stromkreise, Leiterlose Kontaktgeräte, Leitrahmen—Erstausführungen, Abdeckungen—keramisch, Abdeckungen—Metal, Leitrahmen—Serienfabrikation

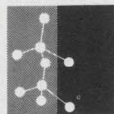

### Everything but the chips

Everything from a single source: One call to any sales office or representative of Alloys Unlimited gives you access to R&D or Production quantities, off-the-shelf or custom parts, everything you need in the packaging of hybrid integrated circuits.

The individual companies which comprise Alloys Unlimited, Inc. are the leading manufacturers of the components listed above. Alloys Unlimited and its subsidiaries constitute a total packaging capability in Hybrids; a single source for top quality and competitive pricing.

#### Source Companies (Subsidiaries or Divisions of Alloys Unlimited, Inc.)

<sup>1</sup>Photoetched—Micro Science Associates, Inc.; <sup>2</sup>Stamped—Montvale Customtool, Inc. <sup>3</sup>Veritron West, Inc. <sup>4</sup>Frenchtown/CFI, Inc. <sup>5</sup>Electronic Materials Div. <sup>6</sup>Frenchtown/CFI, Inc. <sup>7</sup>Cermex Division of Frenchtown/CFI, Inc. <sup>8</sup>Ceramic—Frenchtown/CFI, Inc.; <sup>9</sup>Metal Photoetched—Micro Science Associates, Inc.; <sup>10</sup>Stamped—Montvale Customtool, Inc.; <sup>11</sup>Eutectic Clad—Alloys Unlimited, Inc. <sup>12</sup>Alloys Unlimited, Inc.

Send for our new, free brochure with specifications, prices, ordering information and worldwide office locations.

### Tout sauf les dés semi-conducteurs

Livraison globale depuis une seule source: Un appel à n'importe quel bureau de vente ou représentant de Alloys Unlimited vous donnera accès à des quantités d'étude ou de grande production soit de pièces prises en magasin ou fabriquées sur demande particulière, soit tout ce qu'il vous faut pour faire les assemblages en bloc de circuits hybrides intégrés. ■ Chassis conducteurs ■ Assemblages-blocs ■ Couches de fond ■ Pâtes conductrices ■ Pâtes résistives ■ Blocs conducteurs sans fils de connexion ■ Réseaux résistifs/conducteurs ■ Chapeaux ■ Soudures préformées

Les sociétés particulières entrant dans l'organisation Alloys Unlimited, Inc. sont les fabricants des articles ci-dessus indiqués. Alloys Unlimited et leurs associés présentent une capacité de livraison globale en circuits hybrides; une source unique pour première qualité à des prix méfiant la concurrence.

Demandez notre nouvelle brochure gratuite donnant toutes spécifications, prix, précisions pour commandes et bureaux d'écoulement en tous coins du monde.

#### Fourniture globale pour circuits intégrés hybrides

Assemblages-blocs, Couches de fond, Pâtes conductrices, Pâtes résistives, Réseaux résistifs/conducteurs, Blocs conducteurs sans fils de connexion, Chassis conducteurs—prototypes, Chassis conducteurs—en série, Chapeaux—céramiques, Chapeaux—métalliques

## Alloys Unlimited, Inc.

A.U. Sales Corporation

16661 Ventura Boulevard, Encino, California 91316

Weil International Trading, Ltd., Friars House, 39-41 New Broad Street, London E.C. 2, England



## New Industrial Electronics Review

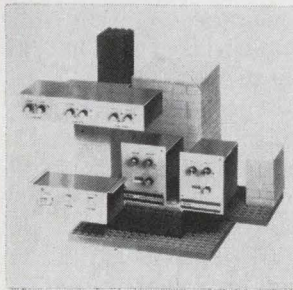

Temperature-control system for industrial processes can hold a given temperature within 0.1°C. Its current output is for driving any size SCR controller to handle any size electric heating load. It uses 4 key building blocks: a power module, thermocouple and millivolt control modules, and an alarm module. Honeywell Apparatus Controls Div., 2727 S. 4th Ave., Minneapolis. [421]

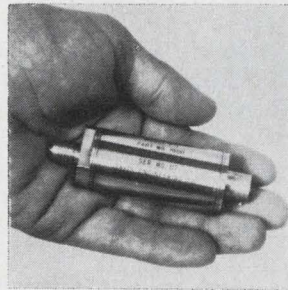

D-c/d-c, variable reluctance pressure transducer series P-1 comes in ranges of 0 to 1 to 0 to 100 psig, psid, or psia. It can withstand over-pressure of as much as 25 to 1. It operates on 28 v d-c unregulated at 6 ma. Output voltage, 0 to 5 v d-c, is isolated from the input and frequency range is flat to 1,000 hz. Tavis Engineering Co., Bootjack Road, Mariposa, Calif. [422]

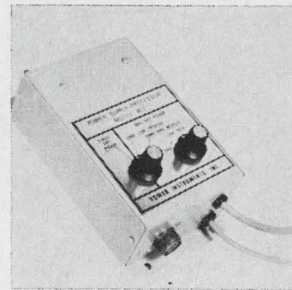

Power supply-processor 922 is capable of actuating electronic digital counters. The unit, in conjunction with magnetic or photoelectric "touchless" pickup (sensors) can operate most of the electronic digital counters on the market for applications such as counting, sorting, controlling, etc. Price is \$65. Power Instruments Inc., 7352 N. Lawndale Ave., Skokie, Ill. [423]



Synchronous stepping motor model SSS-52, featuring instant start, stop and reverse, operates at 75 rpm (from 60 hz) and will provide 30 oz in. torque without gears. It will operate in ambient temperatures as high as 50°C and will not overheat during prolonged periods of rapid deceleration, acceleration and reversing. Bergen Laboratories Inc., 60 Spruce St., Paterson, N.J. [424]

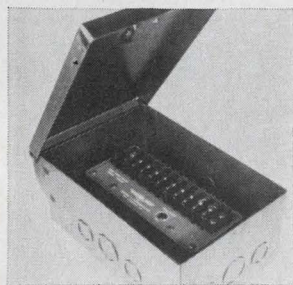

Zero speed switch model AMS99F is used whenever alarm switching or equipment shutdown is required as the speed of a rotating shaft approaches zero. The F style enclosure is a 16 gage steel NEMA box with knockouts at sides, top and bottom for existing electrical connections. Switching occurs at 5 mv or less. Airpax Electronics, Box 8488, Fort Lauderdale, Fla. [425]

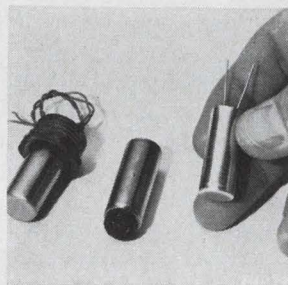

Miniature permanent magnet proximity sensor series 5R is suited for low-current sensing systems operating with numerical control equipment. Rated for resistive loads at 28 v max., 0.25 amp max. and up to 2 w, the unit can be combined with available relays to accomplish higher power switching and control. Tann Controls Co., 20210 Sherwood, Detroit. [426]

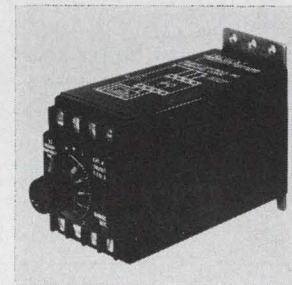

Dual push button safety circuits on punch presses are made tamper-proof by solid state timer model TM2001. An exclusive feature of the unit assures permanent drift-free setting to a fraction of a second. This complete reliability on extremely short fixed time settings results in increased production. Regent Controls Inc., 102 Harvard Ave., Stamford, Conn. 06902. [427]



Time delay relay model TD120, for industrial applications, is available in two variable timing ranges: 0.5 to 30 sec and 1 to 300 sec. Repeat accuracy is  $\pm 5\%$ ; reset time, 100 msec max. Switching capability of the double-pole double-throw unit is 10 amps. Operating temperature range is from  $-10^\circ$  to  $+60^\circ\text{C}$ . Allied Control Co., 2 East End Ave., New York 10021. [428]

### Industrial electronics

## Data converter accepts 20 channels

Unit for computerized monitoring and numerical control handles 10 synchro or a-c signals plus 10 d-c inputs

A computer that controls or monitors industrial processes has to gobble up a lot of information, served to it in many forms and often from many locations.

In a paper mill, for example, there may be hundreds of measurements, from temperature of raw

materials to the speed and tension of paper as it's rolled onto giant spools. In other operations, such as machining, shaft angle information is important; small errors here alter the pitch of threads on a bolt.

Until recently, these scattered and differing inputs required a

large investment in analog-to-digital conversion equipment. But now a single black box can take up to 10 channels of synchro or a-c signals plus 10 d-c transducer signals, converting all to binary digital format without using rectifiers or sample-and-hold networks.

**Civvies only.** The device is a product of the Analogic Co., a division of Gordon Engineering Inc. It's called the model AN5413 13-bit digital converter, and is  $3\frac{1}{2}$  by  $3\frac{1}{2}$  by 12 inches.

Michael Ferber, Analogic's director of marketing, says the AN-5413 is the "only truly commercial a-d conversion system designed to



operate with synchro systems."

Ferber hopes to make sales at the expense of some gear already in operation, such as shaft encoder/counter systems, which, he feels, are more costly and far less reliable than synchros in most applications.

"Since we can digitize up to 10 synchro inputs at a time, we can equal the capability of three triple-axis encoder/counter systems at the cost of one," he says. "And we offer a system whereby almost any kind of data can be converted just by passing it through one black box—a-c, d-c, synchro, it makes no difference.

"Synchro gear has been used in industrial control for several years, but most of it uses technology—even equipment—borrowed from military systems." By designing the system without mil-spec restrictions and spending a little less on noncritical parts, Analogic can sell the AN5413 for a reasonably low price and still offer operation over a temperature range of 1 to 75° C with over-all accuracy of ±0.05%.

**Direct input.** The 20-channel system costs \$3,105. This works out as follows. The device sells for

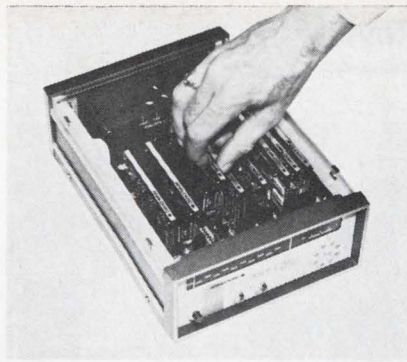

**Modular.** Multiplexer board is added to expand capability of converter.

\$1,950 in single-channel form. To this can be added printed-circuit cards containing a 10-channel (dual) synchro/a-c input multiplexer, including a timing generator and multiplex/decode modules, for \$930, and a 10-channel d-c input multiplexer module for \$225.

The a-d conversion technique also helps keep costs down. It's a successive-approximation method that works directly from input signals. "We eliminate demodulation and signal-conditioning circuitry which might slow the rate of data conversion or cut accuracy," says

James V. DiRocco, Analogic's chief engineer.

Conversion of synchro shaft angle data to a 13-bit word takes only about 100 microseconds and only 50 μsec minimum. Raw a-c sine and cosine information from Scott-transformed synchro/servo outputs is fed directly into the converter. The synchro's own excitation voltage is used as the reference with which the input is compared. Depending on the user's need, the 13-bit word can be the binary equivalent of shaft angle in degrees, sine theta, or cosine theta. The conversion resolution is 2.7 minutes of arc.

A-c inputs are handled like synchro inputs, including the use of external voltage references, so the readout is again a ratio of input to reference. The first bit of the word gives phase (either in phase or 180° out of phase); the others give voltage that's accurate to within ±0.04% and with a resolution of 0.1%.

Delivery time runs from stock to one month.

Analogic Co., 296 Newton St., Waltham, Mass. 02154 [429]

### ENVIRONMENT PROOF ROTARY SWITCHES

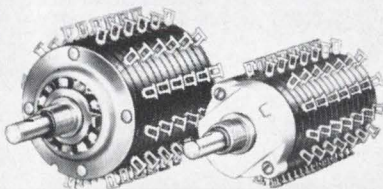

Series 600 1 5/8" Dia.—Series 100 1 1/8" Dia.

- Both index mechanism and electrical sections are completely enclosed.
- Corrosive atmospheres, dust, dirt and moisture are permanently sealed out, lubricants sealed in.
- Solder or quick-connect terminals molded permanently into position minimize production damage.
- Standard index angles include 15°, 30°, 36°, 60° and 90°, special angles available on request.
- Write for engineering bulletin.



**STACKPOLE**  
COMPONENTS COMPANY  
P. O. Box 14466  
Raleigh, N. C. 27610

### SLIDE-TROL® — NEW CONCEPT IN POTENTIOMETER DESIGN

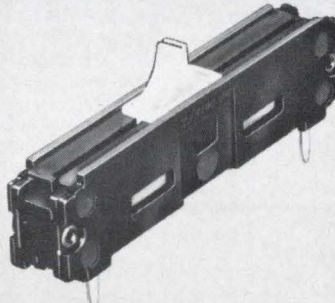

- Mount horizontally, vertically or sideways, either singly or in multiple units.
- Standard solder lug, wire wrap or printed circuit terminals available.
- Low noise and low contact resistance, plus uniform heat distribution.
- Ratings 40-500 Ω 1.5 watts, 500-5K Ω 1.25 watts, 5K Ω and over 1 watt.
- Thermal expansion-contraction and shock hazard problems eliminated.
- Know resistance setting at a glance.
- Compact, lightweight, functional, attractive.
- Write for SLIDE-TROL® Brochure.



**STACKPOLE**  
COMPONENTS COMPANY  
P. O. Box 14466  
Raleigh, N. C. 27610

### SOLVE NOISE AND FILTERING PROBLEMS WITH CERAMAG® FERRITE BEADS

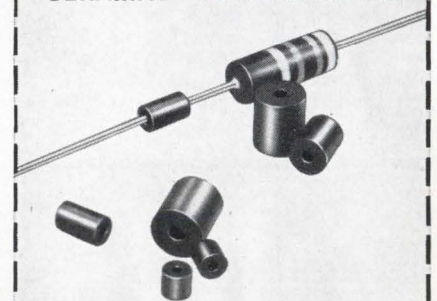

- Ceramag® ferrite beads are low cost, easy to install, and save space.
- Effective r.f. decoupling, shielding and parasitic suppression without sacrificing low-frequency power or signal level.
- Installed by simply sliding one or several over conductor leads.
- Beads can, but need not, be grounded.
- Sizes from .040" ID — .100" OD — 100" L.
- Sample quantities available.



**STACKPOLE**  
CARBON COMPANY  
Electronic Components Division  
St. Marys, Pa. 15857



## Scanner puts it on the line

Infrared system, intended for process-control use, shows temperature profile

**Infrared scanning** has long been considered one of the best ways to perform nondestructive testing. And both Sweden's AGA and the Barnes Engineering Co. recently introduced high-resolution, real-time scanners that display thermographs on the face of an oscilloscope [Electronics, Aug. 5, p. 221].

But for many in industry, particularly those looking for an on-line monitor, these instruments are too costly—\$22,000 and up. And others have grumbled about the problems of training people to interpret the thermographs.

AGA thinks it now has something to silence both factions. Its new

system, called the LS 1, costs \$13,000 and is easy to read. Instead of looking at a two-dimensional area, the LS 1 continuously scans a single line and displays the temperature distribution along that line. Hot spots along the scan show up as peaks along the trace.

The earlier thermographic system is certainly more useful in research, medical, and certain industrial areas, according to Dietrich Baeu, AGA's i-r product manager in the U.S. But he says the LS 1 fits the needs of process-control systems, and he points to the plastics and glass industries as the most likely users.

**Head and traces.** The new scanner consists of an oscilloscope and a detector head mounted on a tripod. On the front of the head is a Mylar window and inside the head is an optical system sitting on a base that rotates 16 times a second. One part of the optical system gathers the radiation coming through the window and focuses it on an indium-antimonide detector that's cooled by liquid nitrogen. The other part of the system is a sighting mechanism the operator

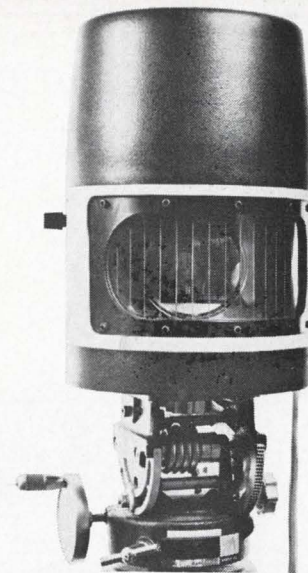

**On the lookout.** A system of lenses and mirrors inside the detector head gathers and focuses i-r radiation

uses to focus the LS 1.

Packed in the back of the head is a heat source that's held at 35°C. Thus the detector gets energy on every revolution from both the target and the constant-temperature heater. The detector uses the target radiation to generate a temperature

### GUARANTEED UNIFORMITY IN ELECTRICAL, PHYSICAL CHARACTERISTICS

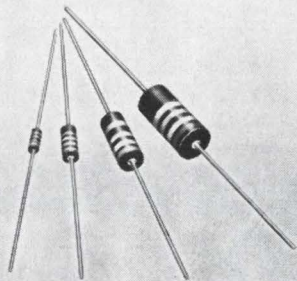

- Available in 2, 1, 1/2 and 1/4 watt sizes.
- Uniform from resistor to resistor, order to order.
- 100% tested for resistance value.
- Same day shipment on 9 orders out of 10.
- Solderability, load life and humidity-temperature characteristic checked.
- Impregnated to assure moisture resistance.
- Write for literature.



**STACKPOLE**  
CARBON COMPANY  
Electronic Components Division  
Kane, Pa. 16735

### NEW SPECIAL PURPOSE RESISTOR PROTECTION



- Currently in use on lightning arrestors, circuit breakers, spark plugs.
- Available in rods, sleeves, rings, special shapes, up to 15" in length and 5" in diameter.
- Ceramic composition favors high voltage applications with high surges.
- Organic Special Purpose Resistors are inexpensive solution where heat dissipation is necessary.
- Both ceramic and organic available in wide range of resistivity values.
- Write for technical assistance.



**STACKPOLE**  
CARBON COMPANY  
Electronic Components Division  
St. Marys, Pa. 15857

### UNIQUE DESIGN ADDS VALUE AND APPEAL

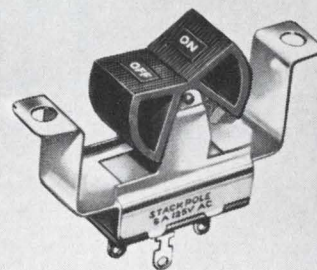

- 23 rocker switch configurations, including 2-3 positions, spring return and center-off.
- Variety of rocker designs available in a spectrum of colors and hot-stamped lettering.
- Listed by UL AND CSA, 1 to 10 amps at 125V AC.
- Solder lug, space saver, quick-connect or printed circuit terminals.
- Field-proven quality same as famous Stackpole slide switches.
- Prices start at less than 15¢.
- Write for engineering literature.



**STACKPOLE**  
COMPONENTS COMPANY  
P. O. Box 14466  
Raleigh, N. C. 27610



0.5 $\mu$ V/ $^{\circ}$ C

**\$67**

(100 LOT)

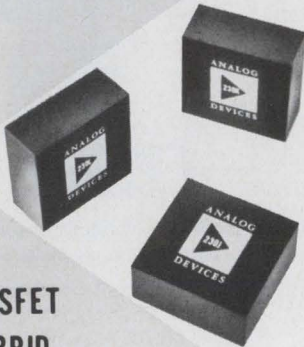

**MOSFET  
HYBRID  
CHOPPER  
STABILIZED  
OPERATIONAL  
AMPLIFIER**

**ANALOG**

221 FIFTH STREET  
CAMBRIDGE, MASS. 02142  
TEL: 617/492-6000  
TWX: 710/320-0326



**DEVICES**

This ad is for the man who already knows that \$67 is a fantastically low price for a chopper stabilized op amp.

Model	J	K	L	Units
E <sub>os</sub>	0.5	0.25	0.1	$\mu$ V/ $^{\circ}$ C
I <sub>bias</sub>	1	0.5	0.5	$\mu$ A/ $^{\circ}$ C
Price	\$67.	\$82.	\$105.	(100 Lot)

Make us prove it...the reader service card will bring comprehensive data sheets, or better yet, request a sample on your letterhead or business card. No obligation to buy, of course.

... light from scanner  
pinpoints hot spot ...

profile, and the heater radiation to generate a reference trace; both traces are displayed on the face of the scope.

The oscilloscope supplied with the LS 1 is a Tektronix 602.

The scanning angle of the LS 1 is 80 $^{\circ}$  and the maximum spatial resolution is 5 milliradians. The system measures from -30 $^{\circ}$  to +200 $^{\circ}$ C and can be focused from 1 meter to infinity.

After aiming and focusing the head, the user selects sensitivity—from 1 $^{\circ}$ C per centimeter—and range on the front panel. He can move the profile up or down the scope face by adjusting a pot, and temperature can be read off the pot's scale at any point where the profile intersects the reference trace. The temperature at any other point along the line is calculated by multiplying the sensitivity setting by the displacement of the point from the reference line.

There's another dial that allows the user to expand a 10 $^{\circ}$ , 20 $^{\circ}$ , or 40 $^{\circ}$  portion of the trace. Yet another dial on the scope's panel is used to position the scanner's field at any particular point.

The warmup time of the system is 5 minutes.

**Alarms and flashes.** Two wrinkles built into the LS 1 should appeal to industrial designers. First, high and low temperature limits can be set with dials on the oscilloscope. Two lines corresponding to the limits selected are on the scope with the profile and reference traces. If the profile crosses either of these lines, a switch inside the LS 1 closes, and this reaction can be used to turn a machine off or sound an alarm.

The other feature is a flashbulb in the detector head. To single out a particular point along the scanned line—a hot spot, for instance—the user centers the field on the particular spot and then turns on the flash. Once every rotation the bulb will flash and the light will be focused by the viewing optics onto the spot.

AGA says the system will be ready for delivery in February.

AGA Corp., 550 County Ave., Secaucus, N.J. 07094 [430]

**Generateur  
de Signaux**

**Frequenz  
Wobbler**

**Sweep  
Generator**

**Interpreted:  
The sweeper is Texscan**

The lightweight, reliable VS-40 sweep signal generator covers the range of 1 MHz to 300 MHz with sweep width variable from 200 KHZ to 300 MHz. Its versatility provides for eight solid state single frequency or harmonic plug-in markers, supplies a 0 to 102 db attenuator and optional calibrated variable marker which covers the complete frequency range of the unit. A 0 to 6 db vernier control is included. The RF output is 0.5v rms into 50 ohms, flatness is  $\pm$ 0.25 db at maximum sweep width. Four sweep rate modes are provided: variable from 5 HZ to 60 HZ, 50/60 HZ line rate, manual sweep and external. Price: \$ 925.00

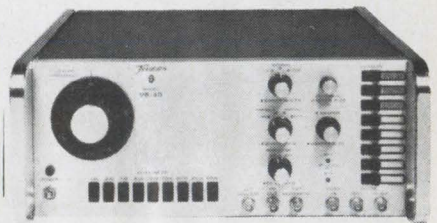

Specialists In Electronic Instrumentation

**Texscan**  
CORPORATION  
2446 N. Shadeland Ave.  
Indianapolis, Indiana 46219  
Ph. (317) 357-8781  
TWX. 810-341-3184



# We've made SUHL a little bit faster.

SUHL integrated circuits have always been known for their high operating speed.

Now, we've added speed where it really counts. In delivery.

Sylvania can now supply the industry's most complete line of SUHL logic off-the-shelf.

And that includes both SUHL I and super-fast SUHL II circuits.

These circuits give you all the well-known advantages of Sylvania's high-level TTL logic design—the design other manufacturers admit to copying.

When you buy SUHL you get flip-flops that can switch at a 50 MHz rate; gates with propagation delays as low as 6 ns. And, of course you get the extremely high noise immunity that is inherent in all SUHL circuits.

So why go to second sources when you can get the originals from Sylvania. And get them fast, too.

Sylvania Electronic Components,  
Semiconductor Division,  
Woburn, Mass. 01801.

**SYLVANIA**  
A SUBSIDIARY OF  
GENERAL TELEPHONE & ELECTRONICS

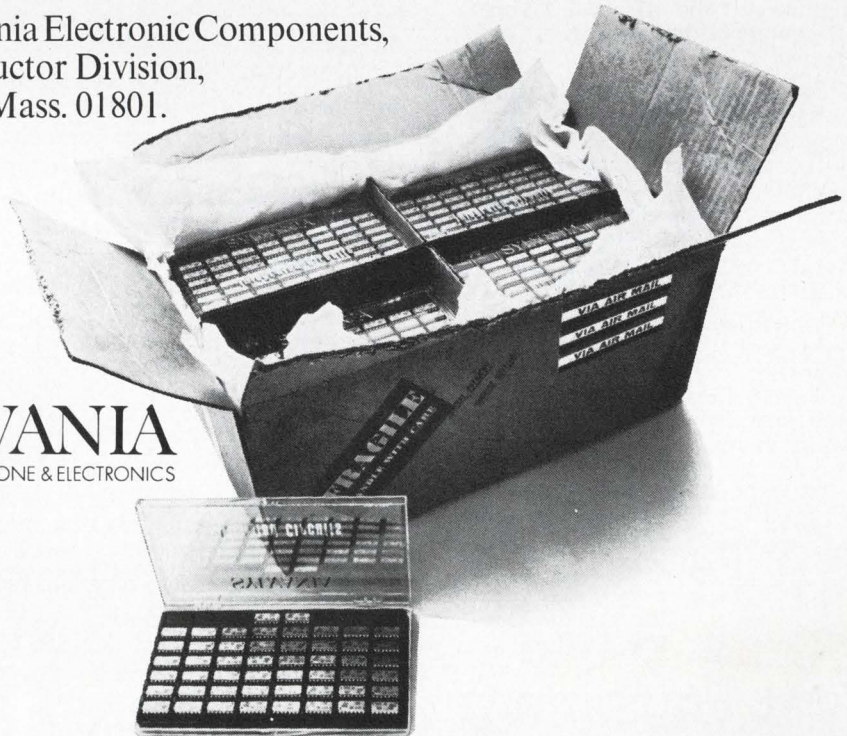

SUHL is a trade name of Sylvania Electronic Products, Inc.





## Semiconductor Burn-in

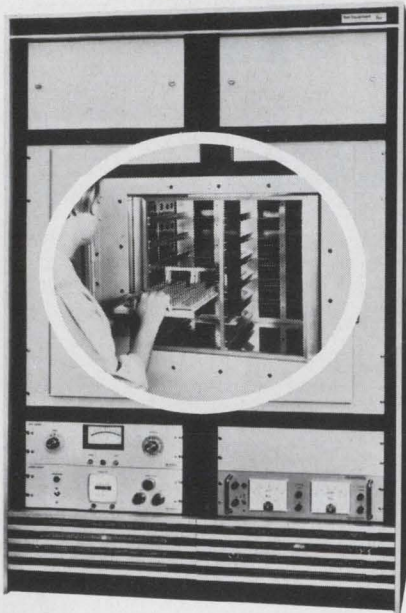

### *Economical TEC power aging and life test systems save you time and money*

Test Equipment Corporation has for years designed and developed sophisticated environmental test equipment. This experience plus total "in-house" capabilities offers both manufacturer and user significant time and cost savings for semiconductor burn-in and life test.

Total "in-house" TEC manufacturing capabilities range from printed circuit boards, fixturing and socketing to NASA-approved machine shop, electrical assembly and micro-welding facilities. This makes possible extremely fast turn-around, thus saving valuable time and money.

In addition, TEC develops, builds and operates for customers complete "in-house" power aging and test facilities capable of meeting the most stringent requirements.

*To discover how TEC burn-in systems and "in-house" facilities can help you, please write for this descriptive brochure.*



## Test Equipment

CORPORATION  
P.O. BOX 20215, DALLAS, TEXAS 75220 • 214/357-6271

## New Books

### Big bargain

Scientific Encyclopedia  
(Fourth Edition)  
D. Van Nostrand Co.  
2,008 pp., \$37.50

Reviewing a book like Van Nostrand's Scientific Encyclopedia is much like trying to describe a leisurely trip around the world in 25 words or less. The best one can do is outline the journey. And a fascinating one it is: elegantly working through the explanation of Kirchhoff's laws of networks, stopping for a moment at the beautiful color photographs of the earth taken from a spacecraft, pausing for a brief, lucid description of holography, or noting the amusing collection of drawings on wrenches.

For \$37.50, the volume (all 2,400,000 words, 125,000 definitions, 16,500 articles, 2,000 pictures, 16 full-color illustrations, and 2,008 pages) is a bargain, both for the engineer-scientist or the layman.

Judging by its coverage of electronics topics, this book is reasonably up to date. It discusses integrated circuits, medical applications of the laser, and various logic schemes, but it tends to describe circuits in terms of both vacuum tubes and transistors—even though vacuum tubes probably haven't been used in some of the circuits discussed for at least 10 years.

The book's value to electronics engineers lies in its coverage of areas such as electrocardiography, the electron microscope, plastics, and radiation terms, where the engineer would be hard-pressed to find a description in his company library. It also is useful for finding out about various effects named after little-known scientists; where would you look, for example, to find out what the Eberhard effect is? (It's a photographic effect introduced in the developing process.)

Single-volume encyclopedias on specific areas—such as biology, chemistry, physics, or space sciences—might be more detailed, but this one volume at least gives the reader a start on each subject. Its big drawback is the lack of even a few pages of bibliography on general subjects to lead the reader to more detailed information.

## ECONOMICAL Thin Film!

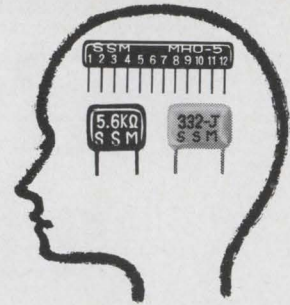

What's needed for memory system is everlasting high accuracy. SSM's components are the very ones satisfying superior reliability.

- Plate-ohm: evaporated metal film resistor
- Pla-module: thin film modulated C-R circuit
- Pla-con: organic thin film capacitor by plasma reaction

### SUSUMU INDUSTRIAL CO., LTD.

Minami Bldg. 1-12 Ebisuminami  
Shibuya-ku, Tokyo, Japan  
TEL: Tokyo (03) 712-5990  
TELEX: No. 246-6270

Circle 167 on reader service card

Cartoon by Whitney Darrow, Jr.



## Be a buddy!

One gift works many wonders  
**THE UNITED WAY**



# 3 THUMBWHEEL SWITCHES

Digital & Binary. Meet MIL-S-22710.

- For Critical Reliability Applications.
- Available with Internal Lighting MIL-L-25467A.



Switch Modules provide *Complete Protection* against hostile environments because both panel and switching elements are separately sealed.

Aluminum Bezel has no visible screws when rear-mounted on miniature and standard type switches.

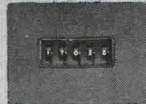

Permanent wafer type miniature decimal switch modules for limited panel space applications.

Removable wafer type switch modules for applications where maintenance time is valuable and rapid servicing is required.

TABET U.S. Patent 2,841,660

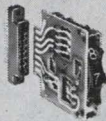

## No down-time in rotary switches

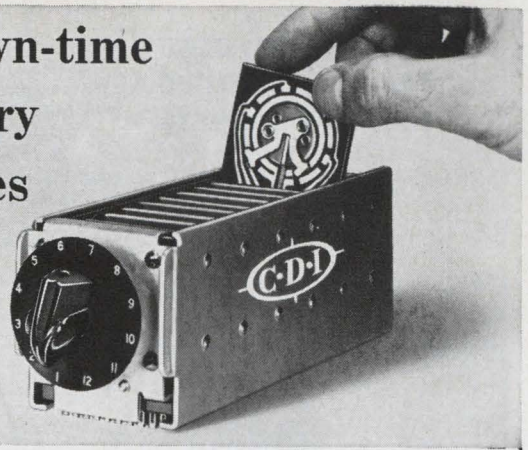

**Unique 5-second wafer replacement obsoletes other switches. Simply lift out old wafer, slip in new wafer. No unsoldering . . . no disassembling . . . no wire removing.**

CDI patented switches with dust covers are available in sizes 2" x 2", 3" x 3", and 4" x 4" with lengths to accommodate up to 36 wafers. Switches can be customized to your specifications.

Operation may be manual, motor or solenoid for use in any rotary selector switch application. Now supplied for numerous military and commercial applications.

Mfd. under Tabet U. S. Patents 2,841,660, 2,971,066, 3,015,000, 2,956,131, 2,988,607.



# CHICAGO DYNAMIC INDUSTRIES, INC.

PRECISION PRODUCTS DIVISION 1725 Diversey Blvd., Chicago, Illinois 60614 Phone: WEllington 5-4600

Circle 168 on reader service card

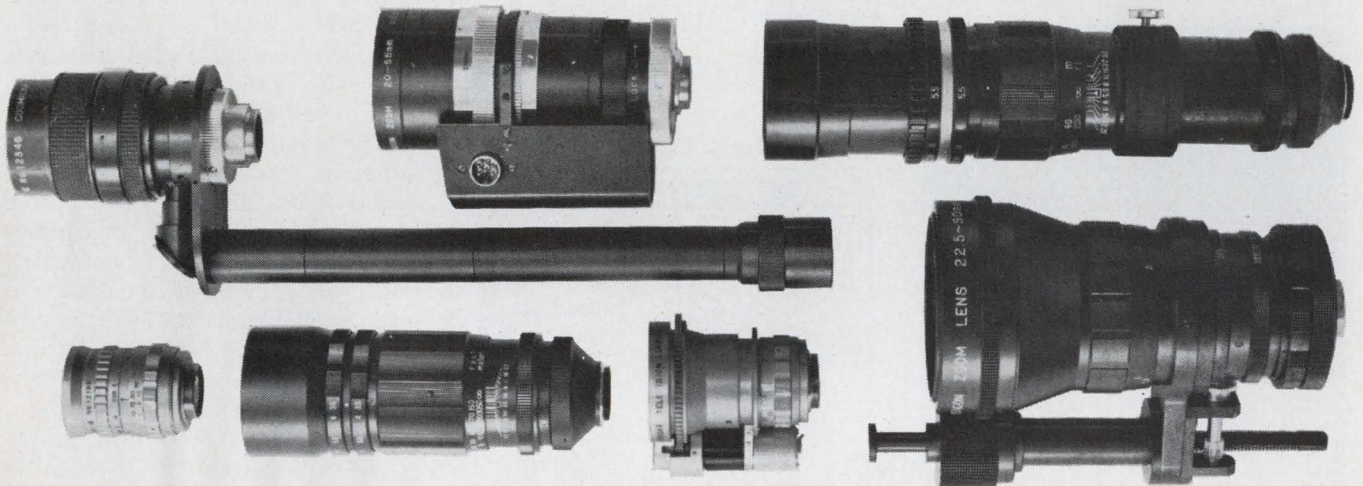

## Perfect your CCTV system with COSMICAR® lenses

Shown are a few selected at random from COSMICAR lenses ranging from 8.5mm to 1,000mm and zooms.

COSMICAR is also prepared to custom-make lenses of any specifications.

Please write today to:



### COSMICAR OPTICAL CO., LTD.

(Former name: ICHIZUKA OPTICAL CO., LTD.)

568, Shimoochiai, 2-chome, Shinjuku-ku, Tokyo Cable Address: "MOVIEKINO TOKYO"



## PAPER TAPE READERS FOR SMALL SPACES AND LOW BUDGETS

MDS Paper Tape Readers are low cost, reliable units engineered to meet your needs in programming and control applications. The line includes Models 2119, 2120, 2121, 2153, 2166 and 2911... and the 2131 Edge-Punched Card Reader.

Simple design and rugged construction characterize these MDS Readers. They incorporate the well-known advantages of star-wheel sensing; reads 5, 6, 7 or 8 level; tape speeds to 60 characters per second; panel or flat-bed mounting. Panel sizes from 3½" x 11" to 8¾" x 19".

For simplicity in design... reliability in action... specify MDS Low-Cost Paper Tape and Card Readers.

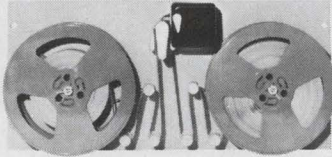

MDS 2121 Paper Tape Reader

MDS Low-Cost Paper Tape Readers make no compromise with quality.

ASK FOR THE MDS FOLDER FILE  
OR MEET YOUR MAN FROM MDS

## MOHAWK MS DATA SCIENCES CORPORATION OEM MARKETING

122 E. Ridgewood Ave. • Paramus, N.J. 07652

Telephone 201/265-7333

Every MDS Office is an OEM Marketing Office

Digital Strip Printers • Buffered Tape Units

High-Speed and Low-Speed Line Printers

Card Punches and Readers

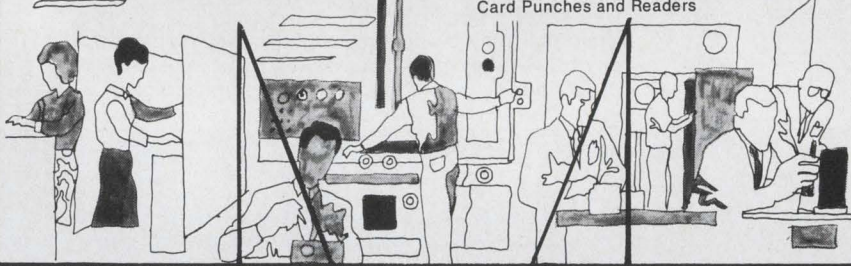

Circle 169 on reader service card

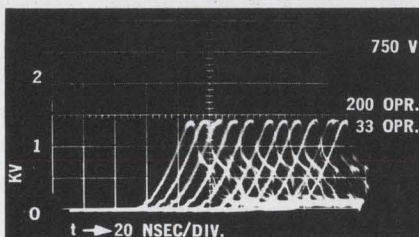

### PRECISION SPARK GAPS\*

Oscillogram of one of Joslyn's spark gap models — the 2001-28 made specifically for RCA—shows exact repeatability. All Joslyn spark gaps feature:

- Ultra-fast response (nanoseconds)
- Long life
- Wide dynamic range
- Stable operation
- Insensitive to light
- No isotope prompting
- Close tolerances
- Hermetically sealed
- Negligible voltage creep
- Lightning — EMP capability available

Ideal for protection of magnetron modulators, microwave stations, dc power systems, output of dc power supplies, all types of signal and data transmission lines, p.c. protectors, control circuits. Available from stock or custom designed.

Write today for new brochure JES-142. Joslyn Electronic Systems, Santa Barbara Research Park, P.O. Box 817, Goleta, California. Tel. (805) 968-3551.



**JOSLYN**  
ELECTRONIC SYSTEMS

\* Patented and Patent Pending

350

CLASSIFIED ADVERTISING

## SEARCHLIGHT SECTION

BUSINESS OPPORTUNITIES  
USED OR SURPLUS EQUIPMENT

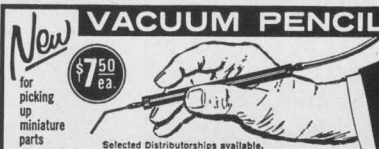

**PHILIP FISHMAN COMPANY**  
7 CAMERON ST., WELLESLEY, MASSACHUSETTS

CIRCLE 970 ON READER SERVICE CARD

### SURPLUS IBM EQUIPMENT

FREE catalog of powers supplies, light & switch panels, semiconductors, test equipment, IC's, optics, etc.

**GADGETEERS SURPLUS ELECTRONICS, Inc.**  
5300 Vine St. Cincinnati, Ohio 45217

CIRCLE 971 ON READER SERVICE CARD

RADAR SYSTEMS GROUND AND AIRBORNE AUTOMATIC TRACKING ANTENNA SYSTEMS NIKE AJAX NIKE HERCULES M-33 MSQ-1A MPS-19 MPS-9 SCR-584 TPS-1D TPS-78 FAA-ASR-2 AIRBORNE SYSTEMS APN-84 APN-102 APS-20 APS-27 APS-45 DPN-19 DIGITAL COMPUTERS IBM 650 IBM 704

LARGEST INVENTORY OF RADAR AND MICROWAVE EQUIPMENT IN THE WORLD.  
**RADIO RESEARCH INSTRUMENT CO.**  
45 WEST 45TH ST. N. Y. 10036 212-JU 6-4691

CIRCLE 972 ON READER SERVICE CARD

### EMPLOYMENT SERVICES

Florida/Nationwide EEs, MEs, IEs... Electronic, Aerospace, Industrial, Sales & Mfg. \$9-18,000. Tech Div Brodeur Personnel Service, Inc., 3947 Blvd., Center Drive, Jacksonville, Fla. 32207

## Technical Abstracts

### Space link

Tropospheric effects on earth-to-space propagation at millimeter wavelengths

Edward E. Altshuler

Air Force Cambridge Research Laboratory, Bedford, Mass.

Millimeter-wave systems have been rarely used for point-to-point communications on earth because the atmospheric attenuation of these frequencies is excessive. However, the millimeter region could be used for earth-to-space communications when more is learned about the atmospheric attenuation such links will experience.

Devices are available that could be used for a system operating around 35 gigahertz, where attenuation is relatively low. Atmospheric attenuation characteristics were studied at this frequency and at 15 Ghz, which isn't strictly in the millimeter band but is still largely unallocated. Actually, it is only the lower atmosphere, or troposphere, that affects propagation. For an earth-to-space communications link, less troposphere is crossed as the satellite approaches zenith, and atmospheric effects become less severe.

In the studies, the sun was used as the source of millimeter-wave radiation. Attenuation was determined radiometrically by pointing an antenna at the sun, measuring the antenna temperature, and plotting the logarithm of the temperature versus the secant of the zenith angle. This plot is a straight line whose slope is equal to the attenuation at the zenith in decibels.

It was found that total atmospheric attenuation at 15 and 35 Ghz is very low when the sky is clear; it becomes excessive during heavy rain. The earth terminal, then, should be in a high and dry area. However, if this isn't possible the rain limitation may be overcome by using a space diversity system; when it's raining at one site, it may be clear at another.

More data that will yield quantitative knowledge about rain attenuation is being obtained at an experimental site located in Hilo, Hawaii.

Presented at the Conference on Tropospheric Wave Propagation, London, Sept. 30-Oct. 2.





**NEW from Cramer**

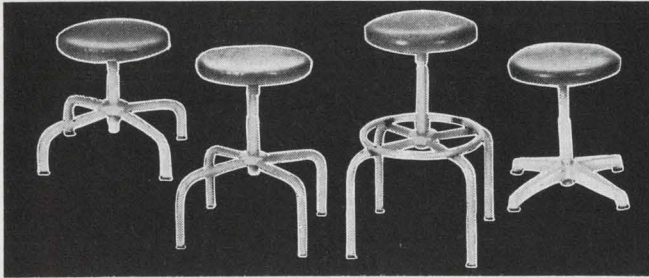

## ADJUST-A-LOK STOOLS

*Adjust to every worker like fine tools!*

Cramer Adjust-A-Lok is immediately adjustable to any workers height. Just release the safety stop, and lift or lower. It can be done just that quick. Since fatigue is a critical factor in efficiency of seated workers, it's just good economics to provide tools that minimize fatigue. With Adjust-A-Lok every worker can find his own most comfortable and efficient level. 6 seat styles and 5 base types provide 30 available models. For more information: write V. P. Sales, Cramer Industries, Inc., 625 Adams, Kansas City, Kansas 66105.

Industrial supplier  
inquiries invited



**CRAMER INDUSTRIES INC.**

A Subsidiary of USM Oil Co.

Cramer — The leader in style and quality

Circle 170 on reader service card

## OBSERVABLE UP TO 10KV!!

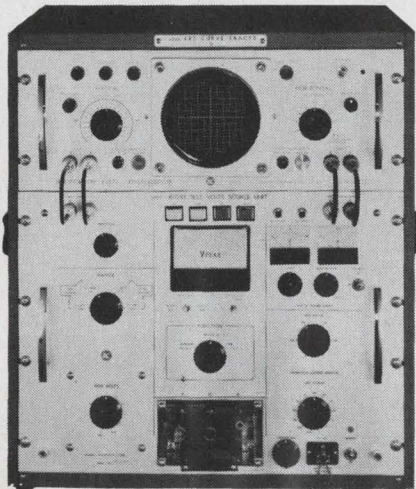

**MODEL  
583  
CURVE  
TRACER**

Internal Test Voltage Supply:

Rectified half wave of power line frequency and sine wave.

Range 0~30V peak, max. 10A peak Low Voltage

0~300V peak, max. 1A peak

0~3kV peak, max. 0.1A peak High Voltage

0~10kV peak, max. 0.1A peak

Gate DC Power Supply:

0~10V continuously variable, 1A max.



**kikusui**

**KIKUSUI ELECTRONICS CORP.**

3-1175, SHINMARUKO-HIGASHI, KAWASAKI-CITY, KANAGAWA-PREF., JAPAN. CABLE ADDRESS: "KIKUSUIDE" KAWASAKI

Circle 171 on reader service card

# The smaller we go,

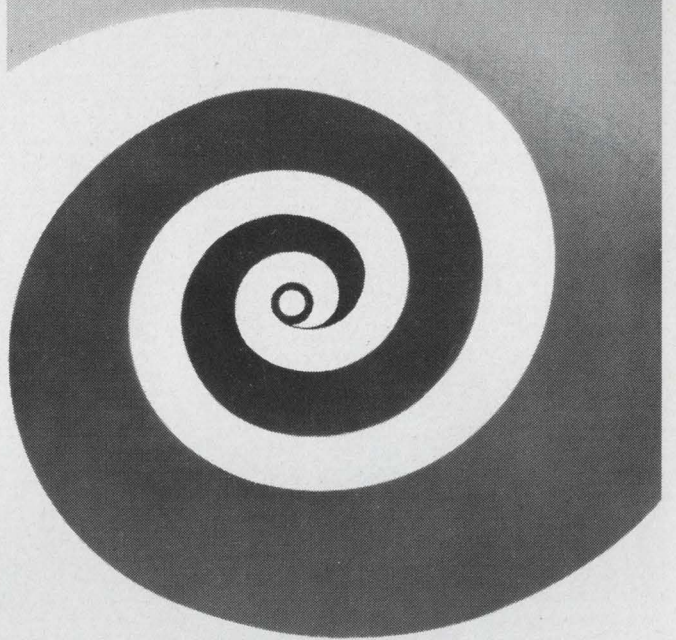

# the faster we grow —

and the faster your computers go and grow, too!

At **Token**, we go smaller every day. We're mass-producing now, for example, 16 mil memory cores. And **Token** 12 mil and 14 mil cores are developing fast. In the process, we're providing manufacturers (including some of the best-known in America) with components contributing to higher-speed computer systems. Also in the process, we're doing what we always do: expanding.

Of course, at **Token**, we've already grown a lot. Our 3000 employees, 30 years' experience, factories second-to-none in scale and skills, plus limitless materials at our disposal—these components have made us the largest maker of memory cores, stacks & planes in Japan. They have produced items like our 2½D memory systems and our peripheral circuits. Items which, from start to finish, are totally **Token**.

Have you gone totally **Token**, too?

**Token**

**Tohoku Metal Industries, Ltd.**

4, 7-chome, Ginza-Higashi, Chuo-ku, Tokyo, Japan

Telephone: Tokyo 542-6171 Cable Address: TOHOKUMETAL TOKYO

Main Products: Ferrite Cores, Memory Cores, Memory Matrices, Ferrite Magnetostrictive Vibrators, Pulse Transformers, Permanent Magnets (Cast, Ferrite), Tape Wound Cores, Bobbin Cores, Magnetic Laminations, Fe-Co Alloys, Sendust Cores

Circle 127 on reader service card

127



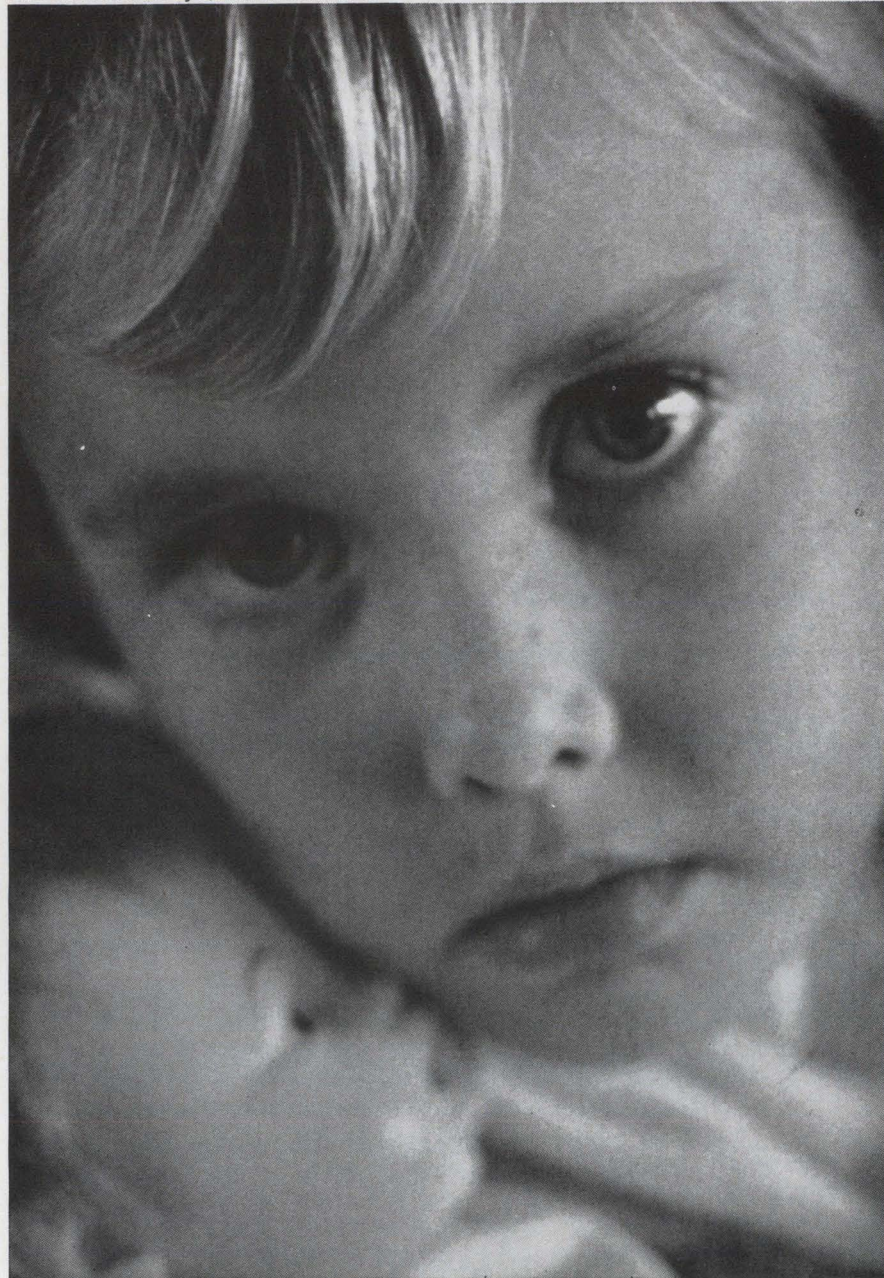

## You can give her hope.

How? Can you find loving parents for her, give her good health, adjust her to the realities of normal living, remedy any physical or other problems troubling her? Probably not.

But you can do this: give the United Way. Support the regular community agencies which provide help for all, all at once, all year long — for the young and old, the ill and troubled, the poor and neglected, for members of the Armed Forces and their families, and for victims of disaster.

Your voluntary United Way gift is your way of being a good neighbor and friend in your community. It is your way of saying you want to help make your community a better place for all families, including your own, through your United Fund or Community Chest.



Your fair share gift works many wonders  
**THE UNITED WAY**



27 million families benefit by child care, family service, youth guidance, health programs, disaster relief and services for the Armed Forces from 31,000 United Way agencies.

## New Literature

**Events indicators.** A. W. Haydon Co., 232 N. Elm St., Waterbury, Conn. 06720. Bulletin MI604 describes micro-miniature events indicators for use on 400 hertz, 60 hertz, and d-c. Circle **446** on reader service card.

**High-gain horns.** DeMornay-Bonardi Division of Datapulse Inc., 1313 N. Lincoln Ave., Pasadena, Calif. 91103. Technical data sheet DB-264 covers modular fiberglass horns in nine sizes offering 2-db nominal gain. **[447]**

**Indicator lights.** Dialight Corp., 60 Stewart Ave., Brooklyn, N.Y. 11237. Two-terminal subminiature indicator lights are described in a 12-page catalog. **[448]**

**Transistor analyzer.** Triplett Electrical Instrument Co., Bluffton, Ohio 45817. Technical specifications of model 3490-A transistor analyzer are given in a two-page data sheet. **[449]**

**Tantalum capacitors.** Sprague Electric Co., 35 Marshall St., North Adams, Mass. 01247. Engineering bulletin 3521B describes type 151D nonpolarized solid-electrolyte Tantalex capacitors. **[450]**

**Coaxial components.** Dielectric Communications, division of Sola Basic Industries, Raymond, Maine, 04701, has available a 72-page applications manual entitled "Coaxial Line and Components." **[451]**

**Antenna capabilities.** Sylvania Electronic Systems, P.O. Box 188, Mountain View, Calif. 94040. A brochure describing antenna design and development capabilities may be obtained by letter-head request.

**Microwave components.** Kevlin Mfg. Co., 26 Conn St., Woburn, Mass. 01801. A 20-page catalog covers solid state switches, miniature coaxial hybrids, couplers and mixers, rotary couplers, and a line of associated microwave components. **[452]**

**Molded sockets.** Electronic Molding Corp., 40 Church St., Pawtucket, R.I. 02860. Product bulletin FS-10 contains complete information on a line of molded sockets for testing and packaging TO-5 case transistors, IC's, and operational amplifiers. **[453]**

**Cam-switch potentiometer.** Markite Corp., 155 Waverly Pl., New York 10014, offers a bulletin on the Rotalign unitized rotary cam-switch potentiometer. **[454]**

**Soldering materials.** Alpha Metals Inc., 56 Water St., Jersey City, N.J. 07304, has available bulletin TR1022, a technical report describing new soldering materials for printed circuits. **[455]**



OVER  
**1,000,000 SIZES**

**MILITARY CASES**

**COMBINATION • TRANSIT • INSTRUMENT**

MIL-T-945A, T-4734, T-21200, STD-108, C-4150



Choose from over 1,000,000 variations in dimensions, proportions, metals, finishes, and custom accessories. Whatever your need, the MM (multi-measure) method gives you high production savings even on custom runs as low as 25 units. Send your print or requirements. Manufacturers representatives in all major cities.

**SEND FOR FREE CATALOG & DIMENSION SPECIFICATION SHEETS.**

**MM ELECTRONIC ENCLOSURES, Inc.**

111 Bloomingdale Rd., Hicksville, N.Y. 11801 • 516-935-9400

Circle 172 on reader service card

## TDK CIRCULATOR

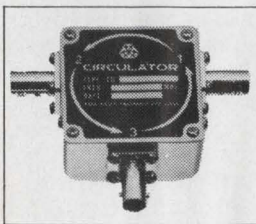

The 200-series Circulators and Isolators are designed for VHF and UHF application up to 1,000MHz. They are compact, high-performance, and low cost, circulators developed by TDK under the guidance of the NHK Technical Research Laboratory.

Write to MH & W for full technical data and information on applications  
Representative in U.S.A & Canada for Ferrite Core for communications



**MH&W INTERNATIONAL CORPORATION**

280 Midland Avenue Saddle Brook, N.J.: 07662  
Phone: N. J. : 201-791-6277 N. Y.: 212-244-0695



**TDK ELECTRONICS CO., LTD.**  
2-14-6 Uchikanda, Chiyoda-ku, Tokyo, Japan

Circle 173 on reader service card

## The Super-Subordinate



### Model CS-17B

- 12 digits, 6 decimal places
- Double-set protection keys
- 4 kg. (8.8 lbs.)

**IC**

Here's one subordinate to which you can confidently delegate all your time-consuming figure work. It's reliable, lightning-fast and has no temperament whatever.

Sharp's revolutionary electronic desk calculator CS-17B.

Created by the world's first and largest maker of IC desk calculators, this compact and economical model instantly reflects its heritage. It silently calculates up to 12 digits, and has automatic decimal. An instrument so light, you can carry it with one hand.

Sharp's CS-17B—the super-subordinate.



### Model CS-22A

- 14 digits, 6 decimal places
- Memory register
- Rounding-off device
- Overflow error check lamp
- Double-set protection keys
- 4 kg. (8.8 lbs.)

**SHARP**

HAYAKAWA ELECTRIC CO., LTD. Osaka, Japan

U.S. Subsidiary: SHARP ELECTRONICS CORP. 178 Commerce Road Carlstadt, New Jersey

Circle 129 on reader service card

129



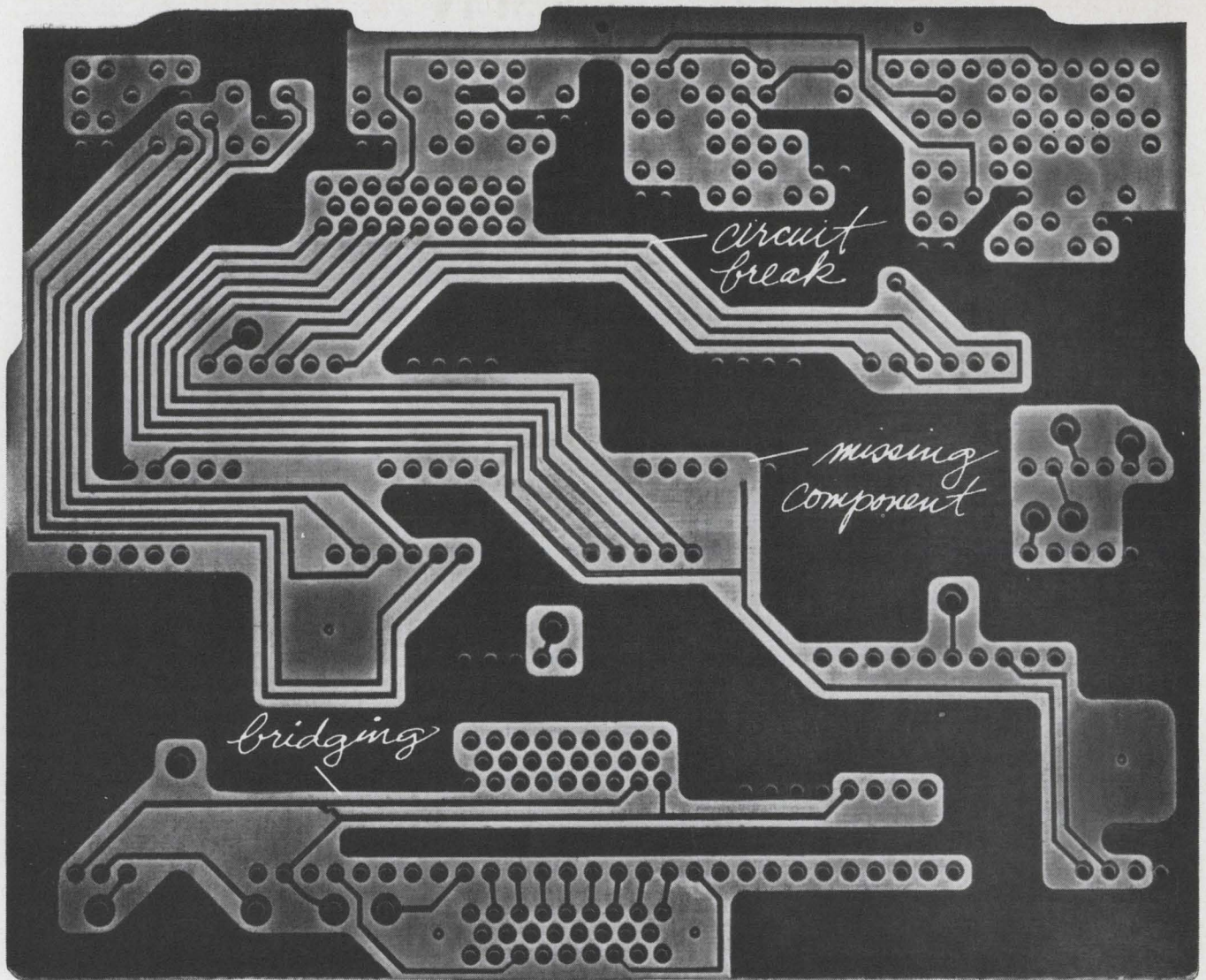

## Avco effectively checks integrity of circuit boards with GAF industrial x-ray film.

Use of multilayer printed circuit boards enables Avco Electronics Division, Cincinnati, Ohio, to turn out smaller and more efficient military radio equipment. And GAF industrial 'H-D' Monopak™ x-ray film helps them get the job done right.

As part of a strict quality control program, Avco subjects each space-saving multilayer circuit board to exhaustive radiographic examination to assure faultless performance and long life. Both the front and back of each 5-layer board are x-rayed to see if there are any circuit breaks, missing components, bridging, misplaced resistors, rotated transistors, etc. and to check if the laminated parts are properly aligned.

For such exacting work, a film is needed to provide outstanding image definition and sharpness... which is why they use GAF industrial 'H-D' Monopak™ x-ray film. Industrial 'H-D' is an ultra-fine-grain, very high contrast film designed to yield high image definition even when radiographing minute subjects and very thin materials.

GAF offers you a complete line of industrial x-ray products with a wide range of speed, grain and contrast characteristics. Find out how GAF x-ray films and matched chemistry can best serve you. Contact your local GAF X-ray Representative. Or write GAF Industrial X-ray Marketing Dept., GAF Corporation, 140 West 51 Street, New York, New York 10020.

15268-1100





---

# International Newsletter

---

December 23, 1968

## Philips shows 'fastest yet' core memory

A feasibility model of a ferrite-core memory that's billed as the world's fastest was quietly shown to some potential customers at the Fall Joint Computer Conference this month. **Its cycle time is specified at 300 nanoseconds, but it can be coaxed to turn over in as little as 250 nsec**, according to its designer, Han A. B. Borsboom, of Philips' Gloeilampenfabrieken of the Netherlands.

The memory's 19-mil cores are made of a special proprietary compound of copper-manganese ferrite that has a quicker switching time than conventional mixes. There are two cores per bit. Both cores switch, but only partially and in opposite directions; the sense winding picks up the difference between them, canceling out most of the noise.

**For this design to work, the cores in each pair must be carefully matched.** Producing such cores requires a special testing technique, according to Philips, but the firm declined to elaborate.

**No faster core memory has ever been planned for commercial sales.** One just about as fast was announced recently as part of Control Data's 7600 computer [Electronics, Dec. 9, p. 45], but it's only about a fifth the size of the Philips design. Some researchers at IBM two years ago built a small experimental memory that operated at 110 nanoseconds, but the company stoutly disclaims any intent to market such a fast memory.

Philips plans to build two production prototypes next year, each with 16,384 words of 36 bits each, and to begin deliveries to customers in 1970.

## GE-English Electric starts reorganizing

General Electric and English Electric Cos. will begin reshaping itself by **grouping its electronics systems and automation activities.** Many observers had thought the company would start instead with its heavy electrical equipment divisions.

The giant, formed this fall by a merger between the General Electric Co. (not related to its U.S. namesake) and English Electric, will **lump its systems companies in a combine called GEC-Marconi Electronics Ltd.** In this group: Marconi Co., GEC-AEI (Electronics Ltd.), and the radar, flight automation, military systems, and space companies of Elliott-Automation Ltd.

The remainder of Elliott-Automation's stable will work in a group called GEC-Elliott Automation Ltd. along with other automation-oriented divisions of English Electric and GEC-AEI.

Companies in the systems group and the automation group will keep their identities. **The new management structure, though, will put each group on the way to a coordinated effort from research through sales.**

## AEG-Telefunken to take control of three firms

West Germany's second-ranking electrical-electronics producer, AEG-Telefunken, will go into 1969 with considerable new strength in consumer electronics. Starting Jan. 1, the company will control three other firms—one Italian and two German.

At home, Telefunken will become the majority stockholder in AKO-Werke GmbH and Neff-Werke, both appliance makers. The two companies together had estimated 1968 sales of \$43 million. **AKO is particularly strong in electronic controls for appliances, and it's a good bet**



# International Newsletter

that Telefunken bought control to inhibit foreign companies hankering for a piece of the German appliance-controls market.

In its Italian deal, Telefunken became sole owner of Telefunken Radio Televisione SpA, a distributor. The holding was acquired from Compagnia Generale di Elettricità, an affiliate of GE.

## Hayakawa to range in U.S. oven market

The Hayakawa Electric Co., which led the sortie of Japanese desk calculator manufacturers into the U.S. market, plans to point the way again, this time for microwave ovens.

The company expects to have Underwriters Laboratories and FCC approval on a household oven early in 1969. After that, Hayakawa will wind up arrangements for exports to the U.S. The Tokyo Shibaura Electric Co. and the Matsushita Electric Industrial Co. are also preparing for an excursion into the U.S. market.

Meanwhile, Hayakawa has surprised its competitors at home by coming out with a \$320 oven. That's about \$65 cheaper than other bottom-of-the-line models.

## EMI renews its bid for more U.S. sales

Look for a renewed sales push in the U.S. by Britain's Electrical & Musical Industries Ltd., which tried—unsuccessfully—to get into the market in a big way in the early 1960's.

To bolster its U.S. position, EMI has picked up a minority holding in B&F Instruments Inc., a Philadelphia-based manufacturer represented in Britain by EMI's instrument-making subsidiary, S.E. Laboratories Ltd. Under the deal, EMI has the right to boost its newly acquired 12.5% holding in B&F to 51%.

The product B&F will sell at first is S.E. Labs' line of ultra-violet recorders. EMI, in turn, will push B&F data loggers in Britain.

The Whittaker Corp. of Los Angeles already sells EMI's photo-multipliers, television camera tubes, cathode-ray tubes, and the like in the U.S. The big British firm is now negotiating an agreement with another American producer for mutual sales of high-power tubes.

## Rank to produce BBC's tv converter

The converter developed by the British Broadcasting Corp. to change American 525-line, 60-field tv pictures to the European 625-line, 50-field standard will be built and sold by Rank Precision Industries, a subsidiary of the Rank Organisation. Each system will sell for \$250,000; Rank officials estimate they'll sell around 25 out of a worldwide potential of 100. Initially, only the U.S.-to-European model will be available, but Rank says it will follow in a few months with a European-to-U.S. version.

## Addenda

Fairchild Semiconductor will set up its European manufacturing operation either in Liege, Belgium, or Wiesbaden, Germany. Company president C. Lester Hogan apparently will choose between the two sometime this week . . . French space officials pressed for a dismantling of the European Launcher Development Organization (ELDO) at this month's meeting with their Italian counterparts. Italian insiders say the French also urged a cutback in the activities of the European Space Research Organization (ESRO) to make more resources available for a communications satellite program.



# Electronics International

## Japan

### Mitey mike

After five years of work, the Sony Corp. has introduced what it describes as the world's first commercial capacitor microphone using an electret—an element that can be considered the electrostatic analog of the permanent magnet. The company has built the mike into a portable cassette tape recorder that went on sale in Japan this month for \$63; export is to start next spring.

Since the electret is permanently polarized, there's no need for the 300-volt polarizing power supply included in conventional capacitor mikes. Also eliminated is the preamplifier.

By getting rid of the power supply and using an integrated circuit containing one field effect transistor and two bias resistors, Sony's engineers have been able to build a small, inexpensive mike with excellent frequency response and high output. And since even the conventional capacitor mike has a better frequency response than the dynamic models now commonly used in tape recorders, the new microphone points to a simple way to upgrade recorder quality.

**Silencer.** Another property of the electret model enabled Sony to build it right into the recorder's case. While the new mike frequency response extends to 20 kilohertz, the self-resonant frequency of the diaphragm is between 20 and 30 khz; and the fact that it's outside the response range keeps noise from the recorder's motor and other components. With a dynamic mike, on the other hand, the self-resonant frequency is around 500 hertz and extensive measures have to be taken to keep the noise level low.

The built-in microphone is non-directional and has a range of 2 to 8 yards. Its diaphragm consists of

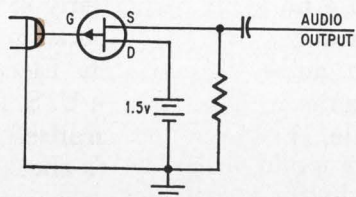
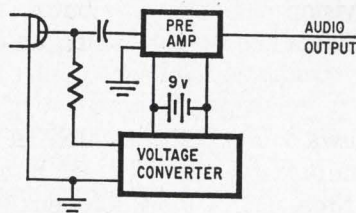

**Less.** Sony's electret capacitor mike, bottom, replaces conventional version in new portable tape recorder selling in Japan for \$63. The simplified schematic shows how the electret model does away with preamplifier and power supply.

an aluminum electrode deposited on plastic film—the electret—which fills part of the space between the electrode and the metal backplate. Sony says the electret's performance depends on both the material used and the processing, but won't give details. However, the material appears to be an inexpensive organic plastic film, so the key to performance would seem to be the processing. The company claims a long life for its electrets; it says that experimental units made two years ago show no drop in their sensitivity, which is about 6 decibels higher than the dynamic mike's.

Output noise in the 20-hertz-to-20-khz range is less than 3 microvolts, and the output is distortionless even for acoustic input pressures as high as 126 phons.

**No strain.** The current drain of the FET IC is low. Sony says it can be operated continuously on a penlight battery for about a year. The input impedance of the circuit is about 800 megohms; output impedance is about 2 kilohms, so a small transformer is used to get

the desired 600 ohms.

With this microphone, Sony appears to have won an international electret race. Northern Electric of Canada has been testing such devices, as has Bell Labs, but neither has yet produced a commercial mike.

### Improving a loser

The use of fiber optic bundles as transmission lines for laser beams promises to open an exciting new avenue of communications. Until now, however, one of the major obstacles to fulfillment of that promise has been that the best available fibers lose about 50% of the signal per meter.

The Nippon Electric Co. and the Nippon Sheet Glass Co. have devised a way to make glass fibers that cut the loss to 10%, less than that of the best glass lenses currently available. Although even that figure is too high for a workable system—2% to 3% would be more like it—it's a giant step in the right direction.

**Space or time.** The fibers, with a continuous variation of refractive index in the radial direction, have a higher refractive index at their center, with fall-off toward the periphery following parabolic law. Those produced so far range in diameter from 50 microns to 3 millimeters. In the laser-communications application, a narrow beam aimed down the center of the fiber will be propagated down the center; one aimed off center will follow a course, determined by the fiber's lens action, shaped like a sine wave.

What's more, the beam will move faster if it's farther from the center of the fiber because of the lower refractive index at the outer portions. Since a sharply defined beam will remain sharply focused at output, the fiber can be used for space-division transmission—pulse-code modulated, for example. And since



time relationships are preserved regardless of path, it can also be used for time-division transmission.

But laser transmission isn't the only possible application for the new fibers. Among the others:

- Lenses without spherical aberrations. Yield is low when making such very small lenses conventionally.

- Transmission of a picture over one fiber rather than with a bundle.

The new fibers might also be used to pick up one image and display it slightly displaced to expose a whole wafer of semiconductors from a single master pattern.

### Empty shelf

That new family of diode-emitter-coupled logic integrated circuits built by Hitachi Ltd. for very fast computers won't be available immediately. The DECL's, being made on a prototype production line, will be used initially for Hitachi's own machines; only when output exceeds internal demand will the circuits be sold.

Described earlier this month at the National Electronics Conference [Electronics, Dec. 9, p. 193], the devices are tailored for large computers with an addition time on the order of 50 nanoseconds. The basic circuit consists of diode AND gates feeding into the emitter follower. For two-stage AND/OR logic, several emitter followers with their AND inputs are connected in a wired-OR configuration.

**More in less.** The diode gate, Hitachi says, eliminates the disadvantages of present ECL circuits. For one thing, it suppresses oscillations; for another, it gives an additional logic stage per circuit, thus sharply reducing the number of elements per logic stage. Finally, the diode reduces the propagation delay-power product.

What results is a logic circuit with a delay of nearly 2 nanoseconds per logic stage—the figure for conventional ECL. However, says Hitachi, its latest devices are inching downward and now provide a delay of just 1.34 nsec, close to the 1 nsec Motorola claims for its

MECL 3. Moreover, use of the new circuit permits design of a register with only one current-switching circuit per bit of register capacity. An ordinary ECL register produced by Hitachi requires four such circuits.

The company says the final level for termination voltage ( $v_{tt}$ ) hasn't yet been decided; more testing is required. Most of the power consumption of the new DECL—or, for that matter, any other high-speed ECL circuit—is in the output emitter-follower pull-down resistor, which is selected mainly on the basis of the drive required from the circuit. That power can be reduced without greatly cutting speed, but even this small sacrifice would make the circuit less useful for a computer. And power consumption, naturally, is directly proportional to the voltage for a given current level.

DECL registers and counters will be hybrid circuits incorporating monolithic flip-flops. Multilayer aluminum interconnections will make possible the close packing needed to maintain high speed.

### Great Britain

#### Light hands

The day is fast approaching, if the engineers have their way, when all timepieces will be electronic. Experiments with various systems and layouts are going on around the world: Japanese and American companies are hard at work, and Philips' West German plant has just developed a piezoelectric drive mechanism [Electronics, Oct. 28, p. 204].

A British company, Sadler Associates Ltd. of Rickmansworth, has put together an electronic clock that has no moving parts but whose display is very much like that of a conventional clock. It was developed under contract to the Swiss watchmaker Solvil et Titus SA and uses ideas generated by the Laboratoire de Recherches Physiques of Geneva. Sadler has made three proto-

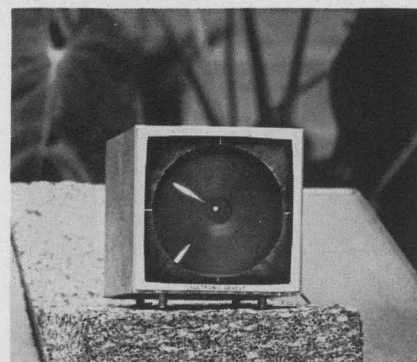

**Time flash.** Electronic clock has light shining through slit for each hour and minute.

types and expects to start production soon.

**Bright face.** The clock is a two-inch cube. The hand-like display is formed by lamps set behind slits in the face. Sixty slits around the edge indicate the minutes, 12 slits slightly closer to the center indicate the hours. Because the "hands" are stationary, the minute hand must jump a full minute every minute, and the hour hand a full hour every hour. The hour hand moves on the 31st minute rather than at the hour to provide the best compromise with the way most people normally think of the time—at 2:30 the hour hand points to the 2, but at 2:31 it points to the 3.

The master timing signals are driven from a quartz crystal oscillator operating at 2 megahertz. Six complex-function TTL flatpack integrated circuits divide this signal into second- and minute-length parts. The minute-long signal is fed to a counter with an 8-bit binary output, which is decoded to energize one of 60 lamp drives, one for each minute of every hour. Every time the 31st minute is reached a pulse is applied to a divide-by-12 counter to give the signal for the hour.

The logic circuitry uses 27 flatpacks mounted on 11 x 2-inch ceramic printed-circuit boards. Ceramic boards are used because their high thermal conductivity assists good thermal distribution inside the silver casing. The logic boards and two similar boards for the crystal and the power supply fit accordion-fashion inside the casing, with



alternate edges wired together so that the whole accordion can be removed and laid out flat for servicing. The bulbs are also mounted directly on p-c boards, and the bulb heads are further supported in recesses in the brass face block. A diffuser plate over the front of the face ensures even distribution of light in the slots.

## West Germany

### Underarm protection

It would have been just the thing to get James Bond or Napoleon Solo out of a tight spot: an electronic gadget to set off an alarm some distance away when Bond or Solo suavely raised his hands at the orders of a gunman. But despite their ability to make things easier for their heroes, neither Ian Fleming nor the producers of "The Man from U.N.C.L.E." ever conjured up anything like that.

Alfred Grotjahn did. Spurred by the growing number of holdups at rural banks and stores in West Germany, Grotjahn, 43, a consulting engineer from Burgdorf, has developed such an alarm system. He's confident that it will be a big seller internationally, with production already under way at Metz Apparatewerke, a radio and television manufacturer in Bavaria. The first units will become available at some consumer electronics outlets around the middle of next month, and large-scale marketing will begin about four weeks later, with a Stuttgart-based firm handling exports. In its present basic form the system will sell for about \$450 in Germany.

**Help!** The heart of Grotjahn's system is a pulse generator that's no larger than a pack of king-sized cigarettes and weighs less than 4 ounces. It's tied under the sleeve to one's upper arm so that it faces the body. When the arm is raised, shaken, pressed lightly against the body, or in any other way moved from a natural position, the generator transmits pulses. The receiver



**SOS.** Inventor Alfred Grotjahn shows how his personal alarm system works. The pulse generator strapped to his arm, when raised, shaken, or moved in any other way, triggers an alarm as much as 1,000 feet away. In its basic configuration, the system will sell for \$450 in West Germany.

triggers the alarm—a bell, buzzer, or horn—or closes the entrance to a bank, starts tv cameras, floodlights an area, or alerts the police.

The pulse generator, housed in a plastic case, contains a 10-milliwatt transmitter, a 6-volt rechargeable battery, and an internal sensing and switching arrangement, the generator's key element. Separate from the generator is a series of flush-mounted switches by which the sensing mechanism can be put on high or normal sensitivity, on automatic or manual operation, or by which the mechanism can be made to react to pressure or release of pressure. There are 27 switch combinations for various kinds of personnel or object protection. The sensing mechanism detects any change in the generator's stationary attitude—whether it's on edge, upside down, right side up—and lateral or vertical movements. It also senses vibrations, shocks, and abrupt movements.

**Messenger.** Because patents are pending in many countries, Grotjahn is reluctant to say exactly how the switching and sensing mech-

anism works. He will say, however, that its operation is based on mechanical and fluid-mechanical principles in which mercury has an important function. The inventor hints that mercury's surface tension, the cross-section of tiny tubes through which it flows, its center of gravity in the fluid system, and other factors come into play in position and attitude changes and start signal transmissions.

The transmitter's range in enclosed areas is a minimum of 50 feet, Grotjahn says. A receiver in the basement of a five-story building will pick up signals from a generator on the top floor with the pulses going through five 6-inch floor slabs.

Outdoors the range is about 1,000 feet, depending on line-of-sight and weather. The transmitter uses carrier frequencies in the neighborhood of 151 megahertz, a band approved by the West German Post Office for such applications. They are amplitude-modulated by pulses around 400 kilohertz. The generator's nickel-cadmium battery gives 50 hours.

**Octet.** The metal-encased re-



ceiver weighs 15 pounds and is 5 by 6 by 15 inches. It can handle inputs from eight pulse generators, with the inputs having different carrier and modulating frequencies. For instance, one might have a carrier of 151.11 Mhz,  $\pm 7$  khz, modulated by a 400-khz pulse. Another might have a 151.13-Mhz carrier and a slightly higher modulating frequency. Eight control lamps indicate each input's origin. The receiver is powered by a 12-volt nickel cadmium battery that lasts 50 to 65 hours.

### Quick as a flash

There are two ways to photograph high-speed objects. The first is to simply move the film as fast as the subject, which presents problems of film breakage when speeds range up to 300 feet per second or more. The second is to keep the film stationary and use a series of spark gaps as light sources that fire sequentially as an object—a bullet, for example—passes the camera. Each flash then illuminates one frame. But there is a flaw: precise illumination is a hit-or-miss proposition because the flash duration and the time interval between successive flashes are difficult to control.

Turning to some simple electronic techniques, engineers at Impulsphysik GmbH have developed high-speed camera equipment that provides flashes in the nanosecond range with an accuracy of better than 30 nsec. This permits them to take pictures at a rate of 1 million a second, or at frame intervals of 1 microsecond.

Impulsphysik, a small firm specializing in off-beat photographic equipment and meteorological measuring gear, says that with a 1-nsec frame separation, pictures of an object moving as fast as 16,400 feet per second, or Mach 15, can be made.

**Shocking behavior.** The equipment, called Chronolite 8, is intended primarily for investigations in aerodynamics and ballistics, for determining shock-wave behavior in gases and liquids, and for many

types of mechanical problems. Since in most kinds of motion analysis only a particular phase—for instance, the entrance of a bullet into safety glass—must be recorded, the number of flashes, and therefore frames, is limited to eight. However, by using several Chronolite 8 setups, more flashes and frames can be made.

Chronolite 8, consisting of an electronic unit, a camera, and a spark head assembly, sells for about \$9,500 on the German market. It was introduced in the U.S. at an exhibition in Washington last month. Walter Thorwart, who heads the engineering team involved in the design, says high-speed motion analysis so far has been done primarily with gear rigged up by the lab itself costing up to \$100,000.

The setup is portable and can be set up fairly quickly. Its flash frequency is variable from 1  $\mu$ sec to 1 second, so the equipment is also good for photographing slow-moving objects. Various kinds of film material—plates, cut film, or Polaroid—can be used with picture formats up to 4 by 5 inches. Since the spark gap is in an enclosed rare-gas chamber, it can achieve light intensities that are a factor of 10 higher than those obtainable in an atmospheric environment. The camera produces eight circular pictures, each with a diameter of 30 millimeters.

**Triple duty.** The electronic unit provides the energy for the spark gaps, generates the time intervals, and synchronizes the series of sparks with the event to be recorded. A trigger is produced when, for instance, a bullet interrupts a light beam or actuates a mechanical contact after it leaves the bore.

The trigger starts the electronic unit's pulse generator, which supplies needle pulses with a half-width of around 40  $\mu$ sec. At the same time the trigger starts the first flip-flop of an eight-flip-flop shift register. Its output, in turn, opens a gate circuit that passes the generator's first pulse. That pulse fires the first of eight thyratons.

The gate circuit also sends a start pulse to the second flip-flop in the shift register. This sequence is repeated at equal intervals in accordance with the preset timing. Each thyatron triggers its corresponding spark gap by way of its associated pulse transformer. After the eight flip-flops have been triggered, a stop pulse shuts off the generator. The equipment is ready to start again about 3 seconds after each series of sparks, when the spark gap capacitors are recharged.

---

### Around the world

---

**France.** In what it's billing as the first use of a cross-field device in telecommunications, CSF-Compagnie Générale de Télégraphie sans Fil has sold its Carpitron tube for use in the ground station being built in Brittany for Intelsat 3. The tube, based on the Carcinotron, a backward-wave oscillator developed by CSF in 1952, is said to be an answer to cross-modulation when a satellite handles multiple telephone conversations.

**Italy.** General Telephone & Electronics' Milan subsidiary has put into experimental service a 2,700-channel microwave link between Milan and Bologna for the Italian Post Office. Aldo Cardarelli, transmission division manager, says the link has the world's largest capacity except for an experimental installation in Japan. The \$400,000 project covers 140 miles and has four hops and two demodulation stations.

**Soviet Union.** Electronics in Russia will continue to expand rapidly in 1969, far outstripping the expected 7.3% general economic growth, according to the annual plan. Exact 1969 production targets and actual 1968 output haven't been spelled out, but the percentage figures give some idea of what's to come. Computer, semiconductor, and transducer outputs are scheduled to rise 31%, and instrumentation is set for a 14% increase. Even tv growth is expected to improve a bit from about 15% this year, to 6.6 million sets.



**TRW**  
*Varicap*  
**DIODES**  
**STRETCH**  
**YOUR**  
**TUNING**  
**RANGE**

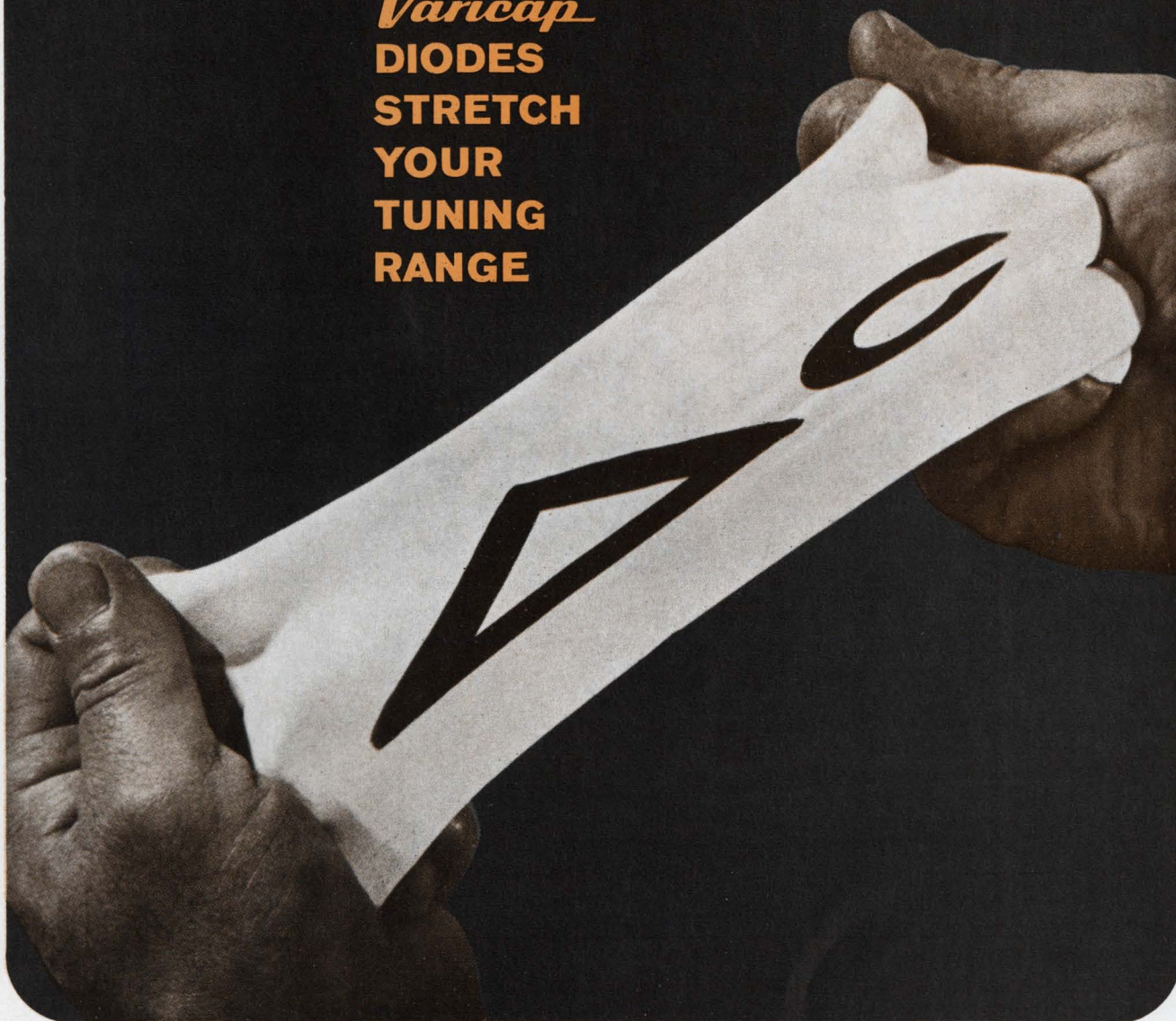

Varicap is the trademark of silicon voltage-variable capacitors manufactured by TRW Semiconductors Inc.

**...up to 20% greater  $\Delta c!$**

You have a lot of things working for you when you design your tuning system around TRW Varicap diodes. First of all, your circuit will provide controlled tuning range to spare — in many cases you can eliminate additional band switching.

Circuitry is simplified and fewer components are required. Varicap-controlled tuning systems assure the performance characteristics

required in the most sensitive communications and monitoring networks.

TRW Varicap diodes are true abrupt junction devices, produced by proprietary processes. This construction gives the designer maximum capacitance change with voltage; optimum uniformity and tracking and superior performance under all operating conditions.

Varicap Bulletin No. 101 discusses wide-range theory in detail. Get a copy from your authorized distributor or write TRW Semiconductors Inc., 14520 Aviation Boulevard, Lawndale, California (213) 679-4561. TWX 910-325-6206. *TRW Semiconductors is a subsidiary of TRW INC.*

**TRW**<sup>®</sup>



# The Six MSD's

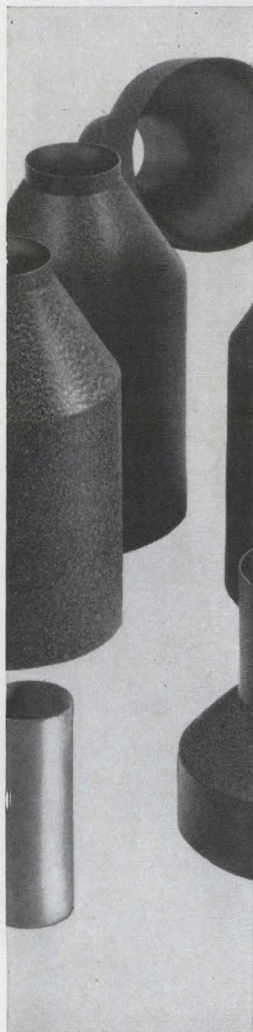

## 1 FABRICATION

MSD's Netic and Co-Netic Magnetic Shields can be fabricated in any size, shape and quantity, from a miniature tube to a shielded room.

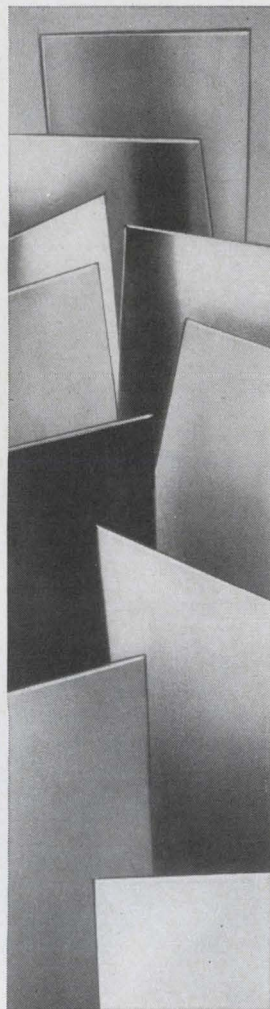

## 2 SHEET STOCK

For fabrication in your plant or ours. Low cost shielding solutions are provided by fully hydrogen annealed Perfection Annealed stock which normally requires no further heat treatment.

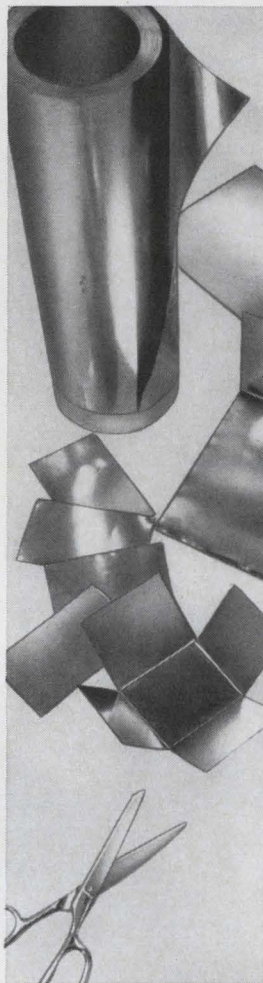

## 3 FOIL

MSD Netic and Co-Netic Foils are ideal for prototype evaluation and production applications. Available in both plain and adhesive backing, they can be easily shaped in minutes to fit your needs.

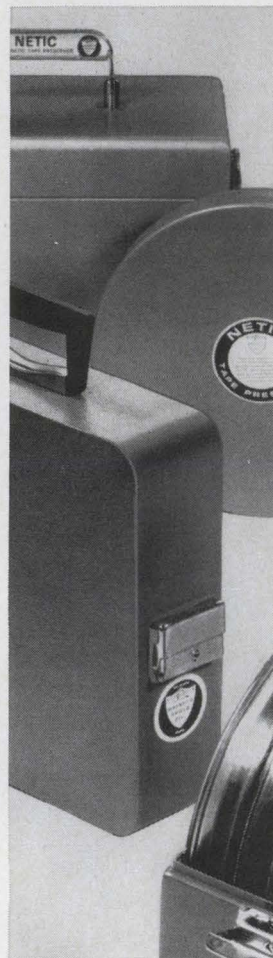

## 4 TAPE PRESERVER CONTAINERS

Used world-wide to protect against loss of valuable tape data. Round and rectangular portable units include the new, smartly designed "Executive." Stacked, sectionalized units for permanent storage are also available.



## 5 TECHNICAL ASSISTANCE

The concentration of design experience and engineering knowledge that has provided over 80% of the magnetic shield designs now in use is yours to assist you in solving an engineering, R&D or production problem. Phone 312, EV 4-2122.



Netic and Co-Netic are not affected by ordinary shock, have minimal retentivity and do not require periodic annealing

## MAGNETIC SHIELD DIVISION PERFECTION MICA COMPANY

740 THOMAS DRIVE • BENSENVILLE, ILLINOIS 60106 (CHICAGO SUBURB)

Phone 312, 766-7800 • TWX 910 256-4815

## 6 FAST, CONVENIENT DELIVERY is the SIXTH MSD.

Some items from stock. Fabricated items 3-4 weeks.





# Electronics advertisers

December 23, 1968

<b>Abbott Transistor Labs, Inc.</b> Technical Adv. Agcy.	22	■ <b>DX Antenna</b> Sanko Sha Adv. Agcy. Co., Ltd.	30E	□ <b>Laboratoire General de Telecommunications</b> Publicite MAB	11E
■ <b>Acopian Corporation</b> Mort Barish Associates	14	□ <b>Dynamco, Ltd.</b> Nicholas Daniels Associates	135	■ <b>Lapp Insulator Co.</b> Wolff Associates	16
□ <b>AEG—Telefunken</b> Werburgs—Makler	31E			□ <b>LTT</b> Promotion Vente Publicite	28E
<b>Allen-Bradley Co.</b> Fensholt Adv. Agcy.	30	■ <b>Electronic Research Assoc., Inc.</b> Josephson Cuffari & Co.	98	■ <b>Magnecraft Electric Co.</b> Mills, Fife & Mac Donald, Inc.	111
<b>Alloys Unlimited, Inc.</b> Hall Butler Blatherwick, Inc.	118	□ <b>Elettrocontrolli</b> Publicitas Spa	27E	■ <b>Magnetic Shield Div., Perfection Mica Co.</b> Burton Browne Adv.	138
□ <b>AOIP</b> Dumesnil Publicite	3E, 4E	■ <b>Elgenco Incorporated</b> Wesco Advertising	140	□ <b>Marconi Instruments, Ltd.</b> Taylor Adv., Ltd.	13E, 29E, 133
■ <b>AMP, Inc.</b> Garceau, Hallahan & McCullough, Inc.	26, 27	<b>E/MC—Medical Electronics Seminar</b>	28, 29	□ <b>Marconi Radio Communication</b> Hampshire House Ltd.	22E
<b>Ampere Electronics Corp., North American Phillips Co. Div.</b> Sam Groden, Inc.	6, 35	□ <b>Epsilon Industries, Ltd.</b> Rede Ward Assoc., Ltd.	12E	□ <b>Marconi Ltd. Space Communications</b> Hampshire House Ltd.	17E
■ <b>Amphenol Corporation</b> Marsteller, Inc.	18, 19	<b>Fairchild Instrumentation</b> Faust/Day, Inc.	10, 11	■ <b>Matsuo Electric Co., Ltd.</b> Daiyusha, Inc. Adv.	106
■ <b>Analog Devices, Inc.</b> Kenen Associates	122	■ <b>Fluke Mfg. Co., John Bonfield Associates</b>	17	<b>Memorex Corporation</b> Hal Lawrence, Inc.	107
<b>Andrew Corp.</b> Fensholt Adv., Inc.	46			□ <b>Mesucora</b>	23E
				□ <b>Metrimpex</b> Hungexpo	20E
				■ <b>MM Electronic Enclosures, Inc.</b> Berin/Pecor, Inc.	129
<b>Beckman Instruments, Inc.</b> <b>Electronic Instrument Div.</b> Hixson & Jorgensen, Inc.	92, 101	<b>GAF Corporation</b> L.W. Frohlich & Co./ Intercon International, Inc.	130	<b>Mohawk Data Sciences Corp./ OEM Marketing</b> MacFarland Assoc., Inc.	126
■ <b>Beckman Instruments, Inc., Heliport Div.</b> Hixson & Jorgensen, Inc.	52	<b>General Dynamics Corp., Electronics Div.</b> Knoth and Meads Co.	113	□ <b>Motorola</b> Semiconductor Products Inc. Propublic	8E, 9E
□ <b>Bernard Golay S.A.</b> Claude Langel	26E	□ <b>General Instrument Europe S.P.A.</b> Studio Cigiemme	6E	<b>National Semiconductor Corp.</b> Hall Butler Blatherwick, Inc.	49, 51
<b>Bissett-Berman Corporation</b> S F Associates	43	<b>General Radio Co.</b> Horton, Church & Goff, Inc.	2nd Cover		
■ <b>Brush Instruments Div. of Clevite Corp.</b> Carr Liggett Adv., Inc.	108	<b>Hayakawa Electric Co., Ltd.</b> Dai-Ichi International, Inc.	129	<b>Philco Ford Corp., Sierra Electronics Operation</b> Hal Lawrence, Inc.	23
■ <b>Bulova Watch Co., Electronics Div.</b> Levy Adv. Assoc.	106	■ <b>Hewlett Packard, Microwave Div.</b> Lennen & Newell, Inc.	2	<b>Phillips Eindhoven, Nederland</b> Media International	12, 13
		■ <b>Hewlett Packard, Palo Alto Div.</b> Lennen & Newell, Inc.	1		
		<b>Hitachi, Ltd.</b> Dentsu Advertising	50	<b>Radiation, Inc.</b> W.M. Zemp & Assoc., Inc.	41
■ <b>Chicago Dynamic Industries, Inc.</b> Burton Browne Advertising	125	<b>Honeywell, Computer Control Div.</b> Creamer, Trowbridge, Case & Basford, Inc.	39	<b>Radio Corporation of America</b> Al Paul Lefton Co.	4th Cover, 60, 61
<b>CMC, Pacific Industries Div.</b> Jones, Maher, Roberts, Inc.	32	<b>Hughes Aircraft Co.</b> Foote, Cone & Belding	93	<b>Radio Materials Co., P.R. Mallory &amp; Co. Div.</b> M.M. Fisher Assoc., Inc.	100
<b>Control Products Division, Texas Instruments Incorporated</b> Horton, Church & Goff, Inc.	3rd Cover				
■ <b>Cosmicar Optical Co., Ltd.</b> Matsushita, Inc.	125	<b>IC Metrics</b> Packer Adv. Corp.	102	<b>Scientific Data Systems</b> Doyle, Dane, Bernbach, Inc.	36
<b>Cramer Industries, Inc.</b> Bryan/Donald Adv., Inc.	127	□ <b>IME S.p.A.</b> Studio Gino Sironi	16E	□ <b>Selenia S.p.A.</b> Tilligraf	14E
<b>CREI, Home Study Div. of the McGraw-Hill Book Co.</b> Henry J. Kaufman & Associates	105	□ <b>Ing. C. Olivetti &amp; C. Spa.</b> Dr. Giuiano Blei	32E	□ <b>SESCO</b> Maurice Ridant, Editions Techniques & Publicite de Firmes	15E
■ <b>CTS Corporation</b> Reincke, Meyer & Finn, Inc.	116, 117	<b>International Contronics</b> Techno Metrics, Inc.	7	□ <b>Sfernice</b> Publicitor	134
□ <b>Cutler-Hammer, International</b> Campbell Mithun, Inc.	21E	□ <b>ITT Europe</b> S.H. Benson Ltd.	24E	□ <b>SGS</b> Bonner Hodgson and Partners Ltd.	2E
		<b>Joslyn, Inc.</b> Chace Company	126	<b>Signetics Corp. Sub.</b> Corning Glass Works Cunningham & Walsh, Inc.	91
<b>Dana Laboratories, Inc.</b> Smith-Klitten, Inc.	20, 21	<b>Kelsey-Hayes Co., Heintz Div.</b> Zimmer, Keller & Calvert, Inc.	15	□ <b>Solartron Electronic Group Ltd.</b> Southern Adv., Ltd.	7E
<b>Data Instruments Div.</b> Technical Marketing	112	■ <b>Kepeco, Inc.</b> Weiss Advertising	110	□ <b>S.P. Elettronica</b> Studio Sergio Rosato	23E, 25E, 27E
□ <b>Drusch Voltreg</b> Publicite Rapy	10E	<b>Kikusui Electronics Corp.</b> General Adv. Agcy., Inc.	127	<b>Sprague Electric Co., The</b> Harry P. Bridge Co.	5, 9
□ <b>Ducati Elettrotecnica Microfarad</b> Studio Gastone Busoli	25E			■ <b>Stackpole Carbon Co., Electronic Components Div.</b> Meek & Thomas, Inc.	120, 121
<b>Duncan Electronics, Inc., Sub. of Systron Donner Corp.</b> Enyart & Rose Adv., Inc.	25				



# ELGENCO Noise Generators

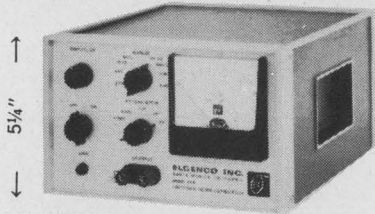

Model 610A

## SOLID STATE NOISE GENERATORS

- Model 602A 5 Hz to 5 mHz, 3 Ranges \$ 360
- Model 603A 5 Hz to 5 mHz, 3 Ranges \$ 545
- Model 610A 5 Hz to 5 mHz, 8 Ranges \$1,275
- Model 632A Two outputs DC to 400 Hz and 10 Hz to 35 kHz . . . . . \$2,595
- Series 624 (Fixed frequency) 5 Hz to 500 kHz \$270 to \$600. Write for details on frequency ranges and spectral flatness.

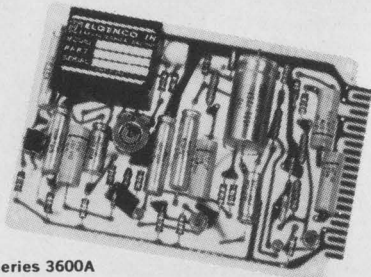

Series 3600A

## NOISE GENERATOR CARDS

- Series 3600 . . . . . \$144 to \$409
- Various frequency ranges and output flatness available. Write for details.

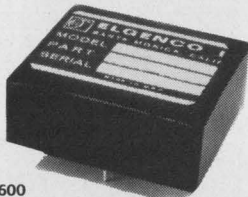

Series 1600

## ENCAPSULATED NOISE SOURCE MODULES

- Series 1600 . . . . . \$95 to \$350
- Various frequency ranges and output flatness available. Write for details.

## VACUUM TUBE NOISE GENERATORS

- Model 301A DC to 40 Hz . . . . . \$2,195
- Model 311A Two outputs DC to 40 Hz and 10 Hz to 20 kHz . . . . . \$2,595
- Model 312A Two outputs DC to 120 Hz and 10 Hz to 20 kHz . . . . . \$2,695
- Model 321A DC to 120 Hz . . . . . \$2,295
- Model 331A 10 Hz to 20 kHz . . . . . \$1,395

For a more complete listing of Elgenco noise generators, write for short form catalog.

## ELGENCO INCORPORATED



1550 Euclid Street  
Santa Monica, California  
Phone: (213) 451-1635  
TWX: (213) 879-0091  
Cable: Elgenco

DEMONSTRATOR MODELS AVAILABLE  
See EEM or Write for Name of Nearest Rep.



- Susumu Industrial Co., Ltd. 124  
Sanko Sha Adv. Agcy. Co., Ltd.
- Sylvania Electric Products, Inc.,  
Electronic Components Group 123  
Doyle, Dane, Bernbach, Inc.
- Sylvania Electric Products, Inc.,  
Parts Div. 99  
Doyle Dane, Bernbach, Inc.
- TDK Electronics Co., Ltd. 129  
Fuji Agency
- Technique et Produits 18E  
Ste de Publicite de Films  
et de Documentaires
- Tektronix, Inc. 94  
Dawson, Turner & Jenkins, Inc.
- Teledyne Relays Co. 114  
S. Michelson Advertising
- Telonic Instruments 8  
Jansen Assoc., Inc.
- Test Equipment Corp. 124  
Dean & Bain Adv., Inc.
- Texas Instruments Incorporated 24  
Industrial Products Group  
Robinson-Gerrard
- Texscan Corp. 122  
Burton Browne Advertising
- Tohoku Metal Industries, Ltd. 127  
Hakuhodo, Inc.
- TRW Semiconductors, Inc. 137  
Fuller & Smith & Ross, Inc.
- Tyco Laboratories, Inc., Instruments Div. 64  
Kenyon & Eckhardt, Inc. Adv.
- Union Carbide Europa 19E  
Young & Rubicam, France
- U.S. Components 45  
Delphi Adv., Inc.
- Ushio Electric, Inc. 136  
Diamond Agcy. Co., Ltd.
- Wang Laboratories 104  
Impact Adv., Inc.

## Classified Advertising

F.J. Eberle, Manager

## EMPLOYMENT OPPORTUNITIES . . . . . 126

## EQUIPMENT (Used or Surplus New) For Sale

- Fishman, P., Co. . . . . 126
- Gadgeteers Surplus Electronics Inc. . . . . 126
- Radio Research Instrument Co. . . . . 126

- For more information on complete product line see advertisement in the latest Electronics Buyer's Guide
- Advertisers in Electronics International

## Electronics Buyers' Guide

- George F. Werner, General Manager [212] 971-2310
- Robert M. Denmead, Midwest Regional Manager [312] MO 4-5800
- Regina Hera, Directory Manager [212] 971-2544
- Thomas M. Egan, Production Manager [212] 971-3140

## Circulation Department

Isaaca Siegel, Manager [212] 971-6057

## Research Department

David Strassler, Manager [212] 971-6058

## Advertising Sales Staff

Frank E. LeBeau [212] 971-6464  
Advertising Sales Manager

Wallis Clarke [212] 971-2187  
Assistant to sales manager  
Donald J. Austermann [212] 971-3139  
Promotion Manager

Warren H. Gardner [215] LO 8-6161  
Eastern Advertising Sales Manager

Atlanta, Ga. 30309: Michael H. Miller, 1375  
Peachtree St., N.E.  
[404] 892-2868

Boston, Mass. 02116: William S. Hodgkinson  
McGraw-Hill Building, Copley Square  
[617] CO 2-1160

Cleveland, Ohio 44113: William J. Boyle, 55  
Public Square, [216] SU 1-7000

New York, N.Y. 10036  
500 Fifth Avenue  
James R. Pierce [212] 971-3615  
John A. Garland [212] 971-3617  
Michael J. Stoller [212] 971-3616

Philadelphia, Pa. 19103:  
Jeffrey M. Preston  
Warren H. Gardner,  
6 Penn Center Plaza,  
[215] LO 8-6161

Pittsburgh, Pa. 15222: Warren H. Gardner,  
4 Gateway Center, [412] 391-1314

Rochester, N.Y. 14534: William J. Boyle,  
9 Greylock Ridge, Pittsford, N.Y.  
[716] 586-5040

Donald R. Furth (312) MO 4-5800  
Midwest Advertising Sales Manager

Chicago, Ill. 60611: Kenneth E. Nicklas  
Ralph Hanning, 645 North Michigan Avenue,  
[312] MO 4-5800

Dallas, Texas 75201: Richard P. Poole, 1800  
Republic National Bank Tower,  
[214] RI 7-9721

Houston, Texas 77002: Robert Wallin,  
2270 Humble Bldg. [713] CA 4-8381

Detroit, Michigan 48226: Ralph Hanning,  
856 Penobscot Building  
[313] 962-1793

Minneapolis, Minn. 55402: 1104 Northstar  
Center [612] 332-7425

St. Louis, Mo. 63105: Kenneth E. Nicklas,  
The Clayton Tower, 7751 Carondelet Ave.  
[314] PA 5-7285

James T. Hauptli [415] DO 2-4600  
Western Advertising Sales Manager

Denver, Colo. 80202: Joseph C. Page, David  
M. Watson, Tower Bldg., 1700 Broadway  
[303] 255-5484

Los Angeles, Calif. 90017: Ian C. Hill,  
John G. Zisch, 1125 W. 6th St.,  
[213] HU 2-5450

Portland, Ore. 97204: James T. Hauptli,  
Thomas McElhinny, 218 Mohawk Building,  
222 S.W. Morrison Street,  
Phone [503] 223-5118

San Francisco, Calif. 94111: James T. Hauptli,  
Thomas McElhinny, 255 California Street,  
[415] DO 2-4600

Pierre Braude Tel: 225 85 88: Paris  
European Director

Paris: Denis Jacob  
88-90 Avenue Des Champs-Elysees, Paris 8

United Kingdom and Scandinavia  
London: Oliver Ball, Tel: Hyde Park 1451  
34 Dover Street, London W1

Milan: Robert Saidel  
1 via Baracchini Phone 86-90-656

Brussels: F.I.H. Huntjens  
27 Rue Ducale Tel: 136503

Frankfurt/Main: Hans Haller  
Elsa-Brandstroem Str. 2  
Phone 72 01 81

Geneva: Denis Jacob  
1, rue du Temple Phone: 31 95 60  
Tokyo: Takeji Kinoshita 1 Kotohiracho  
Shiba, Minato-Ku Tokyo [502] 0656

Osaka: Ryoji Kobayashi 163, Umegae-cho  
Kita-ku [362] 8771

## Business Department

Wallace C. Carmichael, Manager  
[212] 971-3191

Stephen R. Weiss, Production Manager  
[212] 971-2044

Thomas M. Egan,  
Assistant Production Manager [212] 971-3140

Dorothy Carnesin, Contracts and Billings  
[212] 971-2908

Frances Vallone, Reader Service Manager  
[212] 971-2865





## The tradition breakers.

She's not the only one . . . five years ago TI advanced the state of the magnetic circuit breaker art with a smaller, lighter, simpler mechanism. It went over big. More recently, new TI magnetic circuit breakers show similar design breakthroughs. A 100-amp

rating built into a 50-amp frame. A 50-amp rating squeezed into a 25% smaller package. A choice of 20-amp push-button and toggle twins that meet military specifications. A unique magnetic/hydraulic time delay feature. And so on. These and other

breaks with tradition make TI the logical choice to solve your circuit protection problems—quickly, economically, precisely. Write TI Control Products Div., Attleboro, Mass. 02703, or tel. (617) 222-2800 Ext. 368



**TEXAS INSTRUMENTS**  
INCORPORATED

Circle 901 on reader service card



# A new lead to a 300 W, 100 A silicon power transistor in a TO-3 case

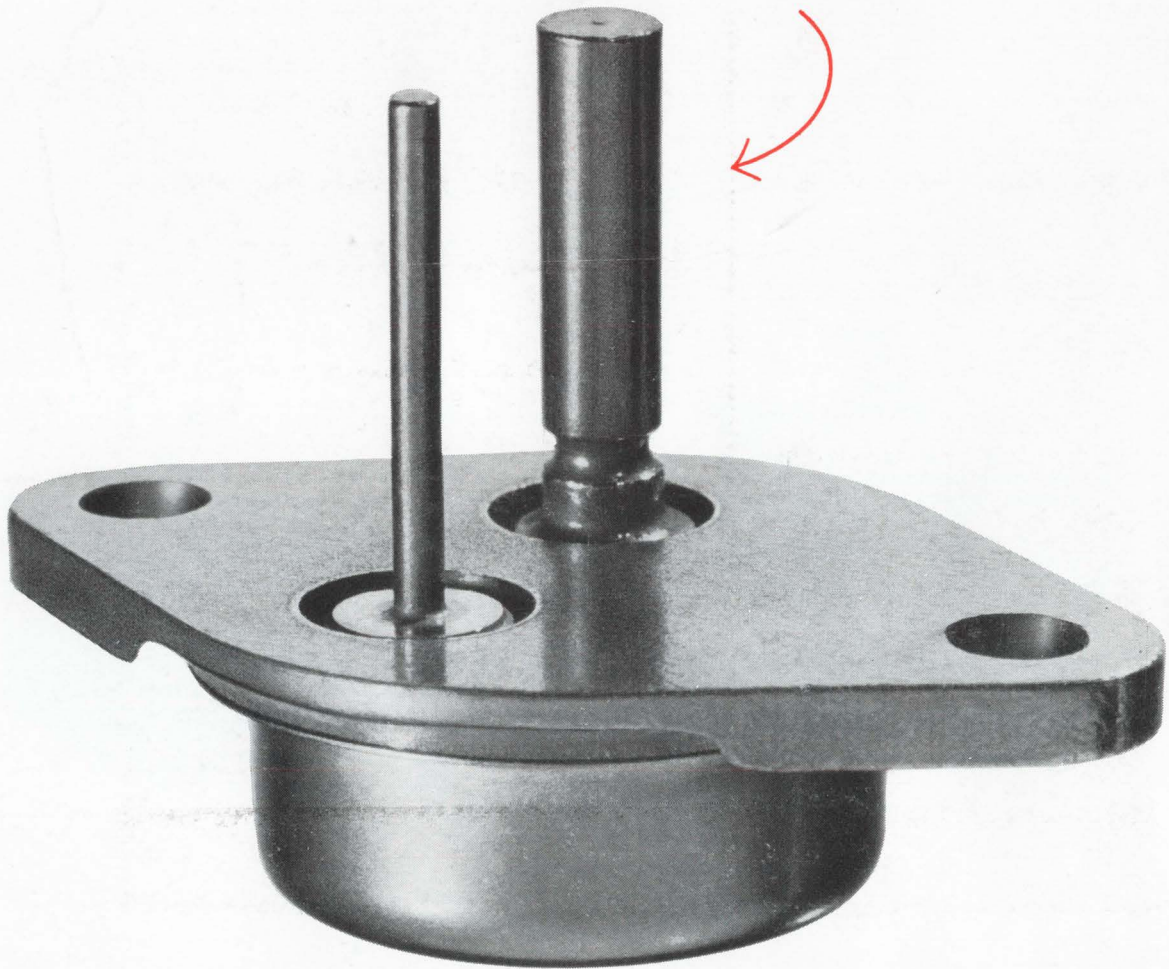

2N5578 showing new, heavy pin terminal design.

What are you looking for in your linear and switching applications? 100 ampere pulsed current capability? 300 watts power dissipation? The highest second breakdown capability of any device on the market in a modified TO-3 package?

Look no further. Here's another first from the silicon power leader—RCA's new 2N5578 family...six high-power, high-current Hometaxial-base silicon n-p-n transistors designed for applications in military, industrial, and commercial equipment.

2N5575, for example, has a pulsed collector current of 100 A. Dissipation

is 300 watts at 25°C with  $V_{CEX}$  (sus) of 70 V. The useful beta range is 10-40 at 60 A.

For complete design flexibility, there are three terminal variations: 2N5575 and 2N5578 have heavy pins; 2N5576 and 2N5579 have soldering lugs; and 2N5577 and 2N5580 have flexible leads with solderless connectors.

This family of types all adds up to circuit cost savings in inverters, regulators, motor controls, and other linear and switching applications. Check the chart. For more information, see your RCA Representative or

your RCA Distributor. For technical data, write: RCA Electronic Components, Commercial Engineering, Section No. I-N-12-2, Harrison, N.J. 07029.

Characteristic	Test Conditions			2N5575 2N5576 2N5577		2N5578 2N5579 2N5580		Units
	$V_{CE}$ V	$V_{BE}$ V	$I_C$ A	Min.	Max.	Min.	Max.	
$\theta_{rc}$	4		40	—	—	10	40	V A J °C/W
$V_{CE0}$ (sus)	4		60	10	40	—	—	
$I_{S/0.1}$			0.2	50	—	70	—	
$E_{S/0.1}^*$	25			12	—	12	—	
$\theta_{jc}$		-1.5	7	0.8	—	0.8	—	
				—	0.5	—	0.5	

†With base forward biased

\*With base reverse biased and  $R_{th} = 10\Omega$ ,  $L = 33mH$