

New cathode brightens matrix displays 98

\$1.00 A McGraw-Hill Publication

Surveying read-only memories 112

March 16, 1970

Emitter-coupled logic is finally making it 121

# Electronics®

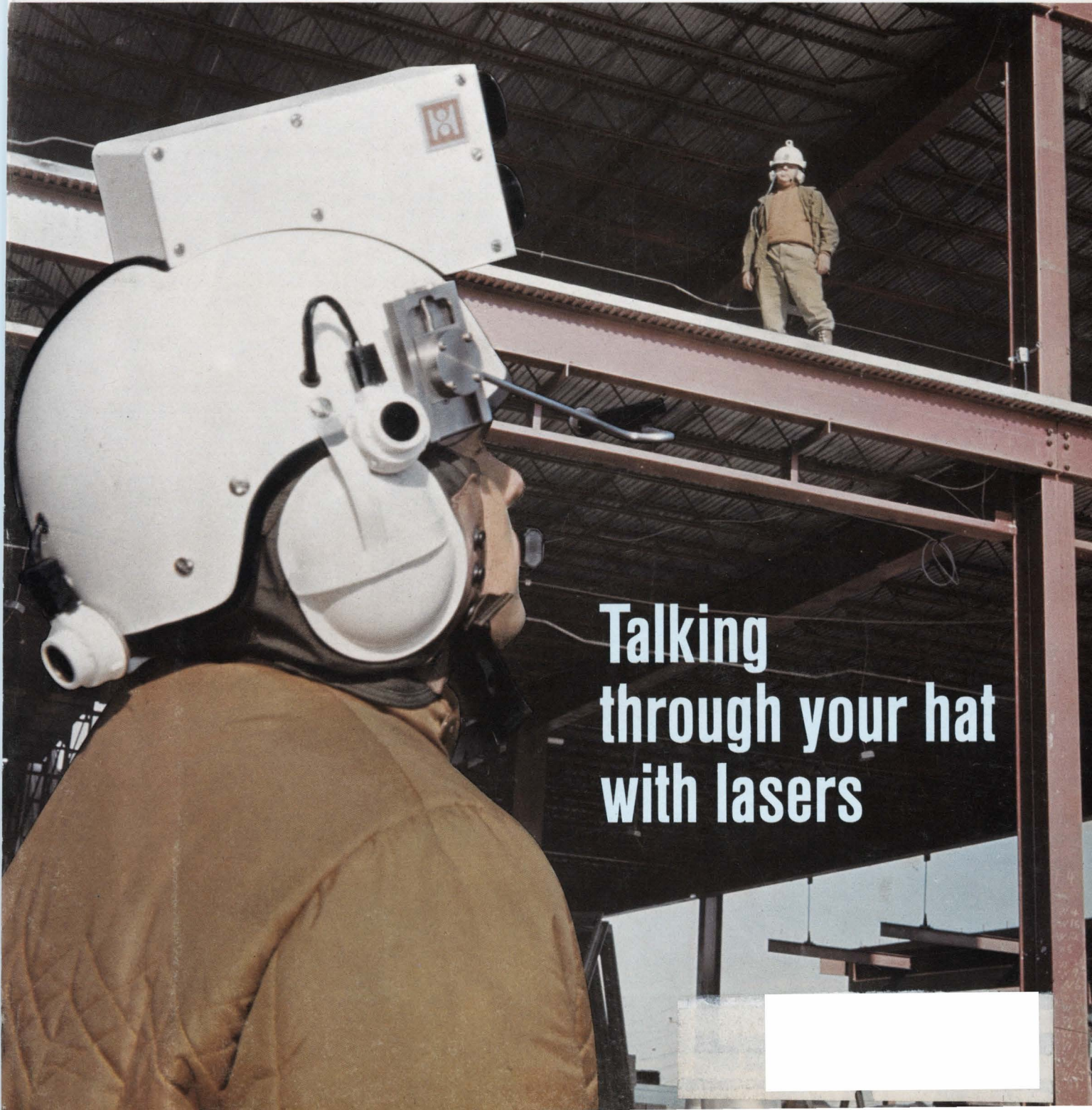

**Talking  
through your hat  
with lasers**



# It's a GRrrrand Counter

Aye, that's what you'll think of our new counter. From its wee size to its big performance, the 1192 is new in every respect.

- It's only 8½ inches wide by 3½ inches high.
- It measures frequency (from dc to 32 MHz), period (single and multiple), time interval, frequency ratio, and, of course, it counts.
- Units of measurement and decimal point are automatically displayed.
- Input sensitivity is another surprise, a wee 10 mV is all you need (up to 25 MHz); and you can control trigger threshold and attenuation.
- An internal crystal oscillator gives more than enough stability for most work.

You can select an 1192 with 5, 6, or 7 digits, with or without BCD output, and for bench or rack use. And if 32 MHz is not enough frequency range for you, add our new 1157-B scaler (same size) to the 1192 and zoom up to 500 MHz. The counter/scaler combination, the 1192-Z, has a common cabinet. There's more, lots more, to tell about the 1192; we'll gladly send you a free data sheet upon request.

But the grandest part of all about the 1192 is the money you'll save when you buy one. Prices\* range from \$575 for the 5-digit bench model without data output to \$845 for a 7-digit rack model with data output. You can add the scaler for another \$850. Imagine, a 500-MHz counter for as little as \$1425. Man, that's a real bargain. You can save quite a few more dollars by ordering two or more units and taking advantage of GR's quantity-discount plan. Discounts range from 3% for 2-4 units to 20% for 100 units.

For free literature (postpaid) or a demonstration at our expense, write or call General Radio Company, West Concord, Massachusetts 01781; telephone 617 369-4400. In Europe (except Scotland), write Postfach 124, CH 8034 Zurich 34, Switzerland. In Scotland, write General Radio Company (U.K.) Limited, Bourne End, Buckinghamshire, England, for special attention.

\*Prices apply only in the U. S. A.

GENERAL RADIO





# Draw your own conclusions with this new time-share terminal.

Now you can have a time-share terminal that lets you see your data graphically— instantly — as it prints out on your Teletypewriter. Now you can plot for comprehension, for meaningful report illustrations, for permanent records. And do it while the time-share data's coming in.

The HP 7200A Graphic Plotter is the first major advance in time-share flexibility since the Teletypewriter itself. The Graphic Terminal feeds from standard EIA ASCII inputs and automatically plots computer data in points, lines, curves, bar graphs, pie

charts, or any other useful engineering, mathematical or business graphics you need. Plot directly from the Teletype keyboard, too, or silence the Teletypewriter and use the plotter alone. It's the end of the graphic time lag.

The HP 7200A is easy to use and requires no special operating or programming/language knowledge. It plots smooth lines, not the staircase drawn by the incremental recorder. And it lets you position the graph where you want it on any type or size of graph paper up to 11" x 17".

Talk to your time-share service about

Hewlett-Packard's new 7200A Graphic Plotter. If your service doesn't offer it yet, have them give us a call. The Graphic Terminal. For people who can benefit from a dash of art with their cold hard data.

**HEWLETT**  **PACKARD**

**GRAPHIC RECORDERS**

11921

Circle 1 on reader service card

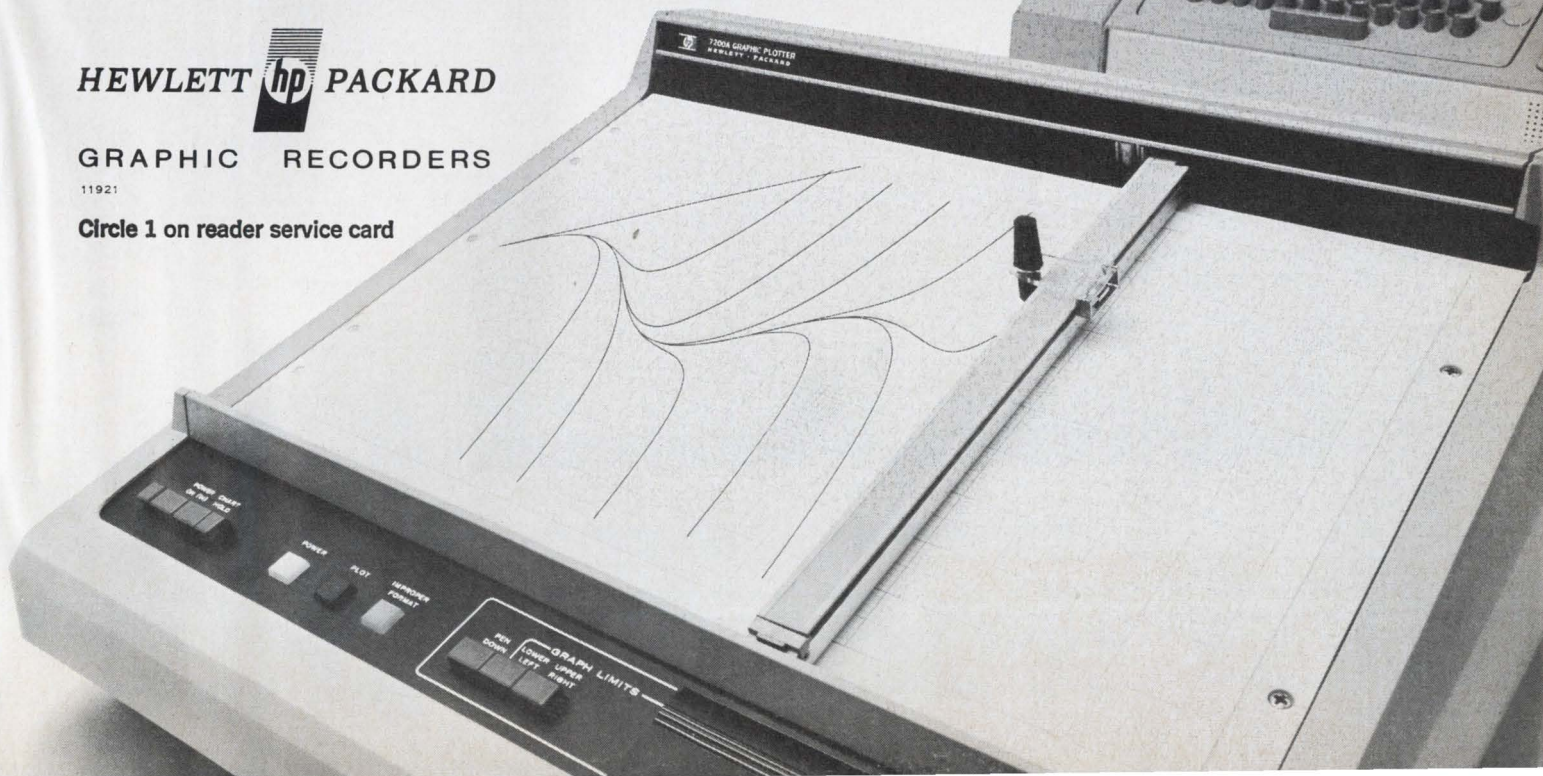



# Now you can make frequency measurements *instantaneously*.

You're looking at the frequency of an information-carrying pulse measured the instant it occurred. Another important breakthrough made possible by the HP 5360A Computing Counter.

This counter is ideal for measuring the frequency profile of even the most advanced communications systems, such as chirp radar and other pulse compression types. As well as pulsed RF, tone bursts and transient signals.

You can measure the Doppler effect on a pulse, and check the incidental FM within the burst. And do it all with accuracy.

Unlike other methods, measurement with the 5360A is not duty-cycle-limited. So you can catch a single pulse, like the one pictured below. And even in short bursts of a microsecond, four digits of frequency information can be obtained.

You can measure the frequency of an RF burst automatically. Also, by triggering the counter, direct instantaneous measurements may be made anywhere within the RF envelope. This feature allows, for example, the frequency profile of a Doppler radar pulse to be measured with ease and accuracy.

With the 5360A mainframe, you can measure from .01 Hz to 320 MHz. Add plug-ins from the popular 5245 counter series, and you can go all the way to 18 GHz. And if you wish, order the 5375A Keyboard which adds extra versatility in programming the counter and in computation involving the measurements as variables. And the 5379A plug-in affords unprecedented versatility and accuracy

in time interval measurement, with resolution to 100 picoseconds.

If you'd like to see how easily the 5360A Computing Counter can handle your frequencies for \$6500, just call your local HP field office. Or write to Hewlett-Packard, Palo Alto, California 94304; Europe: 1217 Meyrin-Geneva, Switzerland.



**HEWLETT *hp* PACKARD**  
ELECTRONIC COUNTERS

02919

Circle 2 on reader service card

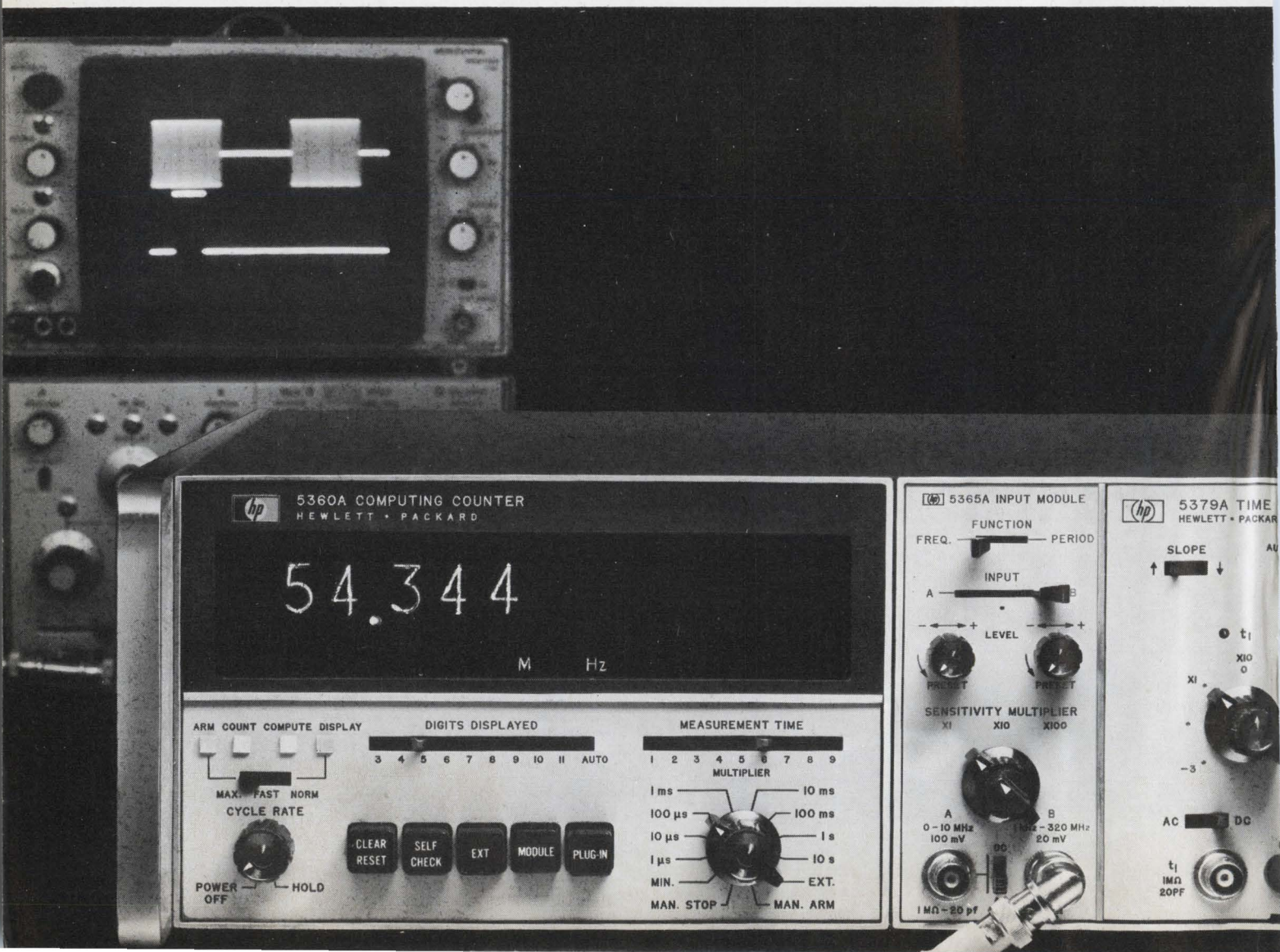



## Features

### Probing the News

- 121 **Solid state:** ECL finally begins to make dent in market  
131 **Space electronics:** NASA goes to unmanned flights to stretch dollars.

## U.S. Reports

- 43 **Microwave:** Paralleling may open solid state doors; lowly FET gains strength; phased-array amplifier  
45 **Communications:** Police seek transceivers tailored to their needs  
46 **Advanced technology:** Work on Ovshinsky effect  
48 **Manufacturing:** "3-D" picture of microcircuits  
50 **Commercial electronics:** Low-cost credit-card reader  
52 **Materials:** Parylene looks good—again; AF-4 version looks better  
54 **Meetings:** Submillimeter wave session could be vital  
54 **Government:** Lockheed pitch for more money makes waves

## Electronics International

- 63 **France:** Strains of music; radar role for Aida  
64 **Great Britain:** Holograms make semiconductor masks  
65 **International:** The right attitude in satellites  
66 **Japan:** Phone calls in color

## New Products

- 137 **In the spotlight**  
137 IC handler speeds testing  
141 **Components review**  
141 IC is converter building-block  
145 **Instruments review**  
145 Multimeter puts emphasis on multi  
148 Q-meter with output voltages  
150 **Subassemblies review**  
150 Vidicon shines at low light levels  
157 **Production equipment review**  
157 Vacuum holds circuit probe in place  
160 **Industrial electronics review**  
160 Photodiode aids machine alignment  
165 **Semiconductor review**  
165 Logic interface IC is multipurpose

## Articles

- Advanced technology** 78 **'Disciplining' photons boosts efficiency**  
New waveguiding structure enhances room-temperature operation; new uses are in offing  
Henry Kressel, Herbert Nelson, Harry Lockwood, RCA Corp.
- Circuit design** 88 **Designer's casebook**  
▪ Zener in bootstrap extends amplifier's range to d-c  
▪ Two MOS FET's form transient-free linear gate  
▪ DTL/TTL controls large signals in commutator
- Communications** 92 **Portable optical communicator rides laser for secure voice transmissions**  
Pulse-position modulation and a low-power GaAs diode are combined in a high-fidelity, single-channel portable system  
Gabor Schlisser and Jules Insler, Holobeam Inc.
- Displays** 98 **Brighter digital readout with dot-matrix tube**  
Recessed cathodes eliminate darkening effects of sputtering for brighter, longer-lived displays  
G.F. Weston and R.F. Hall, Mullard Research Laboratories
- Memories** 104 **Four-wire performance from three-wire memory**  
Pairing sense and inhibit functions on one wire is a logical approach, but designers must be ready for a whole new set of problems  
Tom Gilligan, Electronic Memories & Magnetics
- 112 **There's a read-only memory to fill your needs**  
ROM's are handy design tools; take your pick, you're bound to find just what you need  
John Marino and Jonathan Sirota, Memory Technology Inc.

## Departments

- |    |                          |     |                          |
|----|--------------------------|-----|--------------------------|
| 4  | Editorial Comment        | 33  | Electronics Newsletter   |
| 5  | Readers Comment          | 61  | International Newsletter |
| 9  | Who's Who in this issue  | 71  | Washington Newsletter    |
| 14 | Who's Who in electronics | 171 | New Books                |
| 22 | Meetings                 | 172 | Technical Abstracts      |
|    |                          | 174 | New Literature           |



# Electronics

Editor-in-Chief: Donald Christiansen

## Senior staff editors

Technical: Stephen E. Scrupski

News: Robert Henkel

International: Arthur Erikson

Art director: Gerald Ferguson

Assistant managing editors: H. Thomas

Maguire, Howard Wolff, William Bucci,

Richard Gundlach, Frederick Corey

Special projects editor: Roger Kenneth Field

Senior staff writer: John Johnsrud

Reader communications manager: John Drummond

## Department editors

Senior associate editor: Joseph Mittleman; Advanced technology: Laurence Altman; Communications: Leon M. Magill; Computers: Wallace B. Riley, George Weiss; Design theory: Joseph Mittleman; Instrumentation: Owen Doyle; Military/Aerospace: Alfred Rosenblatt; New Products: William P. O'Brien; Solid state: George Watson, Stephen Wm. Fields.

Copy editors: Edward Flinn, William S. Weiss

Assistant art director: Charles Ciatto

Production editors: Susan Hurlburt, Arthur C. Miller; Editorial research: Virginia Mundt; Editorial secretaries: Claire Goodlin, Bernice Pawlak, Barbara Razulis, Vickie Green, Terri O'Neill.

## Field bureaus

Boston: James Brinton, manager; Gail Farrell; Los Angeles: Lawrence Curran, manager; Ralph Selph; New York: Peter Schuyten; San Francisco: Stephen Wm. Fields, Marilyn Howey; Washington: Ray Connolly, manager; Robert Westgate, Lois Vermillion; Frankfurt: John Gosch; London: Michael Payne; Paris: Arthur Erikson; Tokyo: Charles Cohen

Reprints: Virginia Mundt; Circulation: Isaaca Siegel

Publisher: Gordon Jones

Associate publisher: Dan McMillan

Assistant to the publisher: Wallace C. Carmichael

March 16, 1970

## A silver lining—for those who want it

● The pall of bad budgetary news out of Washington this winter—particularly from the Pentagon and NASA—has tended to obscure the emergence of some bright spots in new business opportunities for the electronics industry. The Justice Department's infant Law Enforcement Assistance Administration, which admittedly hasn't got much money to spend now compared to the military, is a case in point.

But companies aren't exactly breaking down doors to size up this new source of business. It's a tough, fragmented market, and there's a feeling that the industry isn't really willing to commit itself to the growing needs of law-enforcement agencies. Hardware proposals thus far generally have been inadequate. This is what LEAA wants to change.

Money is rapidly becoming available, declares Walter Key, program manager for electronics communications at the National Institute of Law Enforcement and Criminal Justice, LEAA's research arm. "A very substantial part" of the institute's \$7.5 million fiscal 1970 budget will be spent on electronics. In addition, a rough breakdown of the \$50 million in grant-in-aid to local agencies during fiscal 1969 indicates that about 20% was spent on electronics.

And this is just the bottom of a steep growth curve. LEAA's total budget, at \$268 million this year, is quadruple the \$63 million total in 1969, and the Presi-

dent has asked for \$480 million for fiscal 1971. No problems are anticipated in Congress; in fact, members are proposing an \$800 million LEAA budget. And the general feeling is that it will rise to \$1 billion in the not-too-distant future.

Most of the money will be spent at the local level, and in some cases grants will be matched by the states. And, as some in industry see it, this might be the major stumbling block: instead of one customer with one set of requirements, there are hundreds of user-buyers. Police departments aren't used to dealing with industry on the development and procurement level for complex electronics equipment. There is much local divergence of opinion and a lack of understanding, admits LEAA.

Some companies, particularly those oriented toward single military customers, seem to have been spoiled by their familiar methods of dealing with Federal agencies. Few electronics companies presently are interested enough to go out and pound on the doors of police departments and city purchasing agents. And very few new companies are going in and peddling their wares intelligently, say LEAA officials.

Much of the electronic equipment offered to police, LEAA feels, was not designed for law enforcement, but for broader markets. For example, new portable transceivers put on the market recently have many features requested by police, such as higher power output and

Published every other Monday by McGraw-Hill, Inc. Founder: James H. McGraw 1860-1948. Publication office 99 North Broadway, Albany, N. Y. 12202; second class postage paid at Albany, N. Y. and additional mailing offices.

Executive, editorial, circulation and advertising addresses: Electronics, McGraw-Hill Building, 330 W. 42nd Street, New York, N. Y. 10036. Telephone (212) 971-3333. Teletype TWX N. Y. 710-581-4235. Cable address: MCGRAWHILLN.Y.

Subscriptions solicited only from those professionally engaged in electronics technology. Subscription rates: qualified subscribers in the United States and possessions and Canada, \$8.00 one year, \$12.00 two years, \$16.00 three years; all other countries \$25.00 one year. Non-qualified subscribers in the U.S. and possessions and Canada, \$25.00 one year; all other countries \$50.00. Air freight service to Japan \$50.00 one year. Single copies: United States and possessions and Canada, \$1.00; all other countries, \$1.75.

Officers of McGraw-Hill Publications Company: Joseph H. Allen, President; John R. Emery, J. Elton Tuohig, Senior Vice Presidents; Gordon L. Jones Jr., Group Vice President; Vice Presidents: John R. Callahan, Editorial; John M. Holden, Marketing; David G. Jensen, Manufacturing; Jerome D. Luntz, Planning & Development; Robert F. Marshall, Administration; Robert M. Wilhelmy, Finance; Director of Circulation: Ralph Blackburn.

Officers of the Corporation: Shelton Fisher, President and Chief Executive Officer; John J. Cooke, Senior Vice President and Secretary; Gordon W. McKinley, Vice President and Treasurer. Title © registered in U.S. Patent Office. © Copyright 1970 by McGraw-Hill, Inc. All rights reserved. The contents of this publication may not be reproduced either in whole or in part without the consent of copyright owner.

Subscribers: The publisher, upon written request to our New York office from any subscriber, agrees to refund that part of the subscription price applying to copies not yet mailed. Please send change of address notices or complaints to Fulfillment Manager; subscription orders to Circulation Manager. Electronics at address below. Change of address notices should provide old as well as new address, including postal zip code number, if possible, attach address label from recent issue. Allow one month for change to become effective.

Postmaster: Please send form 3579 to Fulfillment Manager, Electronics, P.O. Box 430, Hightstown, New Jersey 08520.



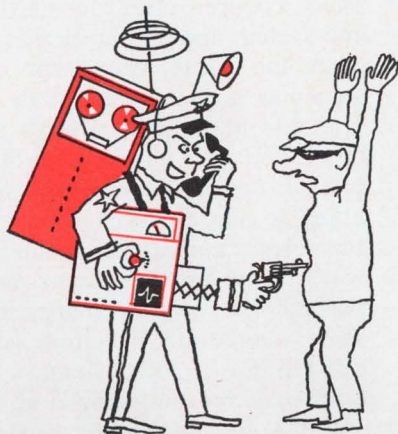

smaller size. But the specifications have been oriented at a much wider range of users in order to justify development, production, and marketing. Because of this, a new personal transceiver has LEAA's highest priority in communications gear. Here's where LEAA believes it can provide major assistance: Key maintains that a substantially improved police transceiver is possible, if designers would consider only the specific requirements of public safety. He believes a unit designed for police alone would provide cost tradeoffs and benefits that would make law enforcement a large enough market in itself.

To do this, LEAA recently sent out detailed questionnaires and received responses from over 400 police departments on what they wanted in a transceiver; the results of the survey were incorporated in the technical specifications of a new police transceiver [see p. 45]. The goal of the specifications that Key wrote for the transceiver was to combine law-enforcement requirements with the current state of the art. LEAA will fund design, development, and even production of the new portable unit. "If this isn't laying out the red carpet" for the electronics industry, Key maintains, "I give up." There's an opportunity here for every segment of the industry—from the one-man consultant to the aerospace giant. But the market isn't waiting on a silver platter; it will require a lot of hard work to tap.—R.H. ●

**McGraw-Hill News Service**

**Director:** Arthur L. Moore; **Atlanta:** Fran Ridgway; **Chicago:** Robert E. Lee; **Cleveland:** Arthur Zimmerman; **Dallas:** Marvin Reid; **Detroit:** James Wargo; **Houston:** Barbara LaRoux; **Los Angeles:** Michael Murphy; **San Francisco:** Margaret Drossel, Tyler Marshall; **Seattle:** Ray Bloomberg; **Washington:** Charles Gardner, James Canan, Herbert W. Cheshire, Seth Payne, Warren Burkett, William D. Hickman; **Bonn:** Robert F. Ingersoll; **Brussels:** James Smith; **Hong Kong:** Kate Mattock; **London:** John Shinn; **Mexico City:** Gerald Parkinson; **Milan:** Jack Star; **Moscow:** Jack Winkler; **Paris:** Robert E. Farrell, Stewart Toy; **Tokyo:** Marvin Petal

To the Editor:

I do not agree with your statement that radomes are on the way out [Feb. 16, p. 83]. The poor performance of the rubber air-inflatable type of radome at Andover, Maine has been known for many years. The basic problems stem from the air-inflated fabric, which after aging, tends to absorb moisture and allow a water film to form on its surface, both of which are detrimental to performance.

However, Tedlar surfaced rigid-metal space-frame radomes are available today which do not absorb moisture or allow the formation of water film on their surface. Dependable and continuous operation of enclosed antenna systems have been demonstrated with these latter-day radome designs. The military is aware of these radomes and is replacing the air-inflated types with the metal space-frame radome for its satellite-communications terminals.

If Comsat's goal is economical, reliable, and continuous operation, I would suggest it reconsider its decision not to use radomes. Even though the Andover radome has its deficiencies, it appears that AT&T was at least originally aware of the fact that a radome enclosed system is superior to an exposed antenna system, otherwise it would never have used a radome for its Andover site.

A. Smolski

Electronic Space Systems Corp.  
West Concord, Mass.

▪ The radome at Andover served to protect from the elements not only the horn antenna, which, unlike dishes, would otherwise tend to clog up, but also a great deal of sensitive equipment which Comsat now houses in separate buildings at new installations. Improvement of color-tv signal and economy are the reasons behind Comsat's move away from radomes. This trend is borne out by the fact that commercial satellite users in other countries have replaced radome sites with exposed antennas.

**Communications link**

To the Editor:

To round out your article on Central American communications [Jan. 19, p. 68], I would like to point out that the Tropical Radio Telegraph Co., has been an international common carrier since 1913, serving the Central American countries with telegraph service between those countries by Morse operation. As the state of the art progressed, we have updated our communications equipment between these countries with the addition of direct telegraph circuits and an interconnecting Telex network.

(continued on page 6)





# The Alameda County Sheriff's Department

uses Farinon microwave and multiplex for reliable long-distance communications.

So do the Michigan State Police, 16 US government agencies, 33 independent telephone companies, 12 Bell telephone companies and 11 public power and light utilities ... among 223 others.

These people serving the US public know all about Farinon performance, reliability and economy, and so can you.

Write for our catalog of microwave, radio and multiplex equipment, accessories and services.

## Farinon

Farinon Electric, 935 Washington St., San Carlos, Cal. 94070

## Readers Comment

Tropical Radio also provides direct telephone service between these countries. Messages filed with Tropical Radio are never transmitted to New York and then returned to the country of destination, except in an emergency where the direct circuit is not operating and we must use an alternate route for urgent messages.

George D. De Young  
Vice president of engineering,  
Tropical Radio Telegraph Co.  
Boston

- Tropical Radio now has direct telegraph circuits, using radio links, and has an interconnecting Telex service, using radio links to Miami, where the company has a soon-to-be-computerized switching center. The company, a wholly owned subsidiary of the United Fruit Co., serves Honduras, Nicaragua, Costa Rica, and Panama, which is linked by undersea cable. In addition, the company is planning to use the microwave link to be established by the five Central American governments.

### Premium 'brake'

To the Editor:

There are ramifications to your story on radar braking [Jan. 5, p. 155] that should be explored. In most states the fellow who plows into the rear end of another vehicle is held liable. This being so, perhaps insurance companies might grant favorable premium rates to owners of cars equipped with such a system. In any event, a rate-of-closure radar system connected to

the brakes should do more to insure the proper wearing of seat belts and safety harnesses than any promotional campaign to date—at least it would after the first time the system applies the brakes.

In the same vein, why can't someone invent a gadget to cope with the idiot who tailgates at 70 mph? The can't-kill-me attitude displayed by some drivers is exasperating, to say the least. In view of the current conditions on the highways, radar braking seems an important first step. Perhaps, if the same magnitude of effort is applied to it as to lesser items, a \$100 EOM cost could be arrived at.

Can you imagine the consternation that would ensue if a car broke down during the rush hour and stopped 20 miles of vehicles in a matter of seconds.

F.C. Hervey

Charlotte, N.C.

### 'Reorientateded capacitors'

To the Editor:

With reference to the phrase "the capacitive display screen" [Feb. 2, p. 46], I realize that sooner or later we shall all have to become "reorientateded." In the meantime, however, can those of us whose "capacitors" are overloaded hope for some editorial protection?

T.R. Jackson

Black Mountain Engineers  
Corinth, Vt.

- Occasionally a gremlin does creep in which accounted for the appearance of "capacitive" instead of capacitive.

### SUBSCRIPTION SERVICE

Please include an Electronics Magazine address label to insure prompt service whenever you write us about your subscription.

Mail to: Fulfillment Manager  
Electronics  
P.O. Box 430  
Hightstown, N.J. 08520

To subscribe mail this form with your payment and check  new subscription  renew my present subscription

Subscription rates: qualified subscribers in the U.S.: 1 year \$8; two years, \$12; three years, \$16. Non-qualified: 1 year \$25. Subscription rates for foreign countries available on request.

### CHANGE OF ADDRESS

ATTACH LABEL HERE

If you are moving, please let us know five weeks before changing your address. Place magazine address label here, print your new address below.

name \_\_\_\_\_

address \_\_\_\_\_

city \_\_\_\_\_

state \_\_\_\_\_

zip code \_\_\_\_\_



# PIRGO SOLVES YOUR POWER HYBRID CIRCUIT PROBLEMS...

## WITH SILICON PLANAR POWER TRANSISTOR CHIPS

Known for consistent high quality and field-proven dependability, all Pirgo chips (dice) are 100% D-C probe tested, and are guaranteed to an LPTD of 10%.

High current NPN and PNP types (up to 30 amps) are available for immediate off-the-shelf delivery. They can also be obtained with gold backing for convenient, easy mounting to ceramic substrates.

There are economic advantages, too. Because no one else has lower prices, Pirgo transistor chips will bring down the cost of your hybrid circuit. You'll get top service...and all the technical advice you ask for. Affiliated with Sprague Electric Company, Pirgo draws upon the full resources and sales staff of that company.

Send directly for a copy of our new catalog and price list. Or call your local Sprague Electric sales engineer.

SILICON PLANAR POWER TRANSISTOR CHIP SPECIFICATIONS

NPN TYPE NO.	I <sub>C</sub> Max. AMPS.	BV <sub>CEO</sub> VOLTS	BV <sub>CEO(sus)</sub> VOLTS	BV <sub>EBO</sub> VOLTS	h <sub>FE</sub> @ 0.5 AMPS	F <sub>T</sub> (TYP) MHz	PNP TYPE NO.
PG-3001	2	80	60	8	50 min	90	PG-4001
PG-3002	2	100	80	8	50 min	90	PG-4002
PG-3303	2	140	120	8	50 min	90	PG-4003
PG-3004	2	160	140	8	50 min	90	PG-4004
PG-3005	2	180	160	8	50 min	90	PG-4005
NPN TYPE NO.	I <sub>C</sub> Max. AMPS.	BV <sub>CEO</sub> VOLTS	BV <sub>CEO(sus)</sub> VOLTS	BV <sub>EBO</sub> VOLTS	h <sub>FE</sub> @ 1 AMP	F <sub>T</sub> (TYP) MHz	PNP TYPE NO.
PG-3101	5	60	40	8	40 min	70	PG-4101
PG-3102	5	80	60	8	40 min	70	PG-4102
PG-3103	5	100	80	8	40 min	70	PG-4103
PG-3104	5	120	100	8	40 min	70	PG-4104
PG-3105	5	140	120	8	40 min	70	PG-4105
NPN TYPE NO.	I <sub>C</sub> Max. AMPS.	BV <sub>CEO</sub> VOLTS	BV <sub>CEO(sus)</sub> VOLTS	BV <sub>EBO</sub> VOLTS	h <sub>FE</sub> @ 5 AMPS	F <sub>T</sub> (TYP) MHz	PNP TYPE NO.
PG-3201	10	60	40	8	40 min	60	PG-4201
PG-3202	10	80	60	8	40 min	60	PG-4202
PG-3203	10	100	80	8	40 min	60	PG-4203
PG-3204	10	150	120	8	40 min	60	PG-4204
PG-3205	10	160	140	8	40 min	60	PG-4205
NPN TYPE NO.	I <sub>C</sub> Max. AMPS.	BV <sub>CEO</sub> VOLTS	BV <sub>CEO(sus)</sub> VOLTS	BV <sub>EBO</sub> VOLTS	h <sub>FE</sub> @ 10 AMPS	F <sub>T</sub> (TYP) MHz	
PG-3301	30	60	40	8	40 min	40	
PG-3302	30	80	60	8	40 min	40	
PG-3303	30	100	80	8	40 min	40	
PG-3304	30	140	120	8	40 min	40	



130 CENTRAL AVENUE  
FARMINGDALE, NEW YORK 11735  
Tel: 516-694-9880 • TLX: 96-1498

See Pirgo at the Sprague Booths 3D11 thru 3D18 at the IEEE Show.



# more functions in less space

radiation hardened magnetic Flat Pak modulators, analog multipliers, demodulators mount directly on IC cards.

- Flat Pak design only 0.1" thick.
- Zero Hysteresis.

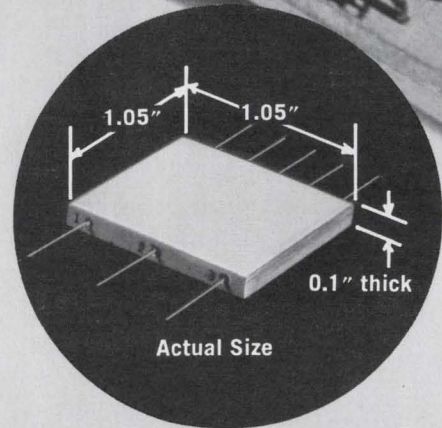

## Product accuracy 1% absolute or 2 MV whichever is greater

- Hybrid assemblies mount directly on IC cards.
- Space saver design . . . typical dimensions 0.1" thick x 1.0" x 0.75".
- Rugged design, extreme reliability. MTBF design goal 0.25 per million hours.
- Extremely low drift over  $-55^{\circ}$  to  $+125^{\circ}$ C range.
- Not affected by high intensity nuclear radiation.
- No external nulling or offset adjustments.
- No additional components or temperature compensation required.
- No external operational amplifiers required.
- Standard  $\pm 15$  V DC power supplier unless otherwise specified.
- Linearity: Better than 1% absolute or 2MV whichever is greater.

Analog Multiplying Functions:

$$\begin{aligned} \pm DC \times \pm AC &= AC \\ \pm DC \times \pm DC &= \pm DC \\ AC \times AC &= AC \\ \pm DC \times AC &= \pm DC \\ AC \times AC &= \pm DC \end{aligned}$$

### MAGNETIC MULTIPLIERS

Dynamic Product Range

**80 db**

### Magnetic Modulators

Dynamic Range:

**60 db**

As an Analog Multiplier of a Bipolar DC signal times an AC signal, the output **product accuracy** is 1% of point, or 2 MV, whichever is greater over a dynamic range of 10,000:1 in each quadrant.

Over the temperature range of  $-55^{\circ}$ C to  $+125^{\circ}$ C, the following parameters hold:

- 1) Zero Point Drift: ... Less than 2 MV of in phase component
- 2) Gain Slope Stability: ..... Less than 2% change
- 3) Dynamic range and output wave quality independent of temperature variations
- 4) Distortion: ..... Less than 1%

Typical input/output parameters:

X Signal: ..... 0 to  $\pm 5$ V

Y Signal: ..... 0 to  $\pm 5$ V

Output: ..... 0 to 5V RMS across 5K or greater load impedance

Magnetic DC x DC Multiplier

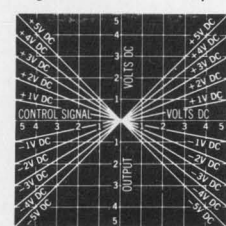

Squaring

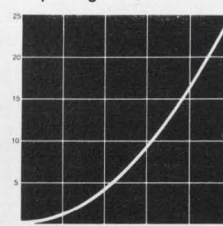

Square Root

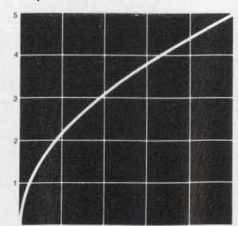

Division

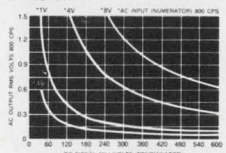

Amplitude Modulation

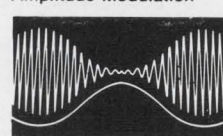

Balanced Modulator

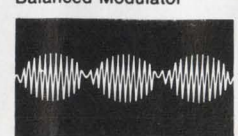

There is No Substitute for Reliability  
**GENERAL MAGNETICS, INC.**  
 135 Bloomfield Avenue,  
 Bloomfield, New Jersey 07003



# Who's Who in this issue

**A team** that attends the same school often goes on to score successes in industry together. That's been the story of George F. Weston and Raymond F. Hall, authors of the article on the dot-matrix display cell that starts on page 98. Both received degrees from London University—Weston in 1951 and Hall in 1957—and since 1955, both have worked together at the Mullard Research Laboratories as part of a team, lead by Weston, studying gas-discharge phenomena. Weston and Hall did much of the work in basic physics that made possible the close voltage tolerances on Mullard's present range of trigger and counting tubes. Weston is the author of a book called "Cold-Cathode Glow Discharge Tubes" and is a fellow of the Institute of Physics. Hall is an associate member.



Weston

Hall



Insler

**Familiarity** breeds a bright career, and Gabor Schlisser, author of the article beginning on page 92, is thoroughly familiar with modulation and synchronization techniques. Manager of the Electronics division at Holobeam Inc., Schlisser has four patents pending in his specialty. He holds BEE and MEE degrees from the City College of the City University of New York, has done advanced work at Columbia University, and has been taking business courses at Farleigh Dickenson University. Co-author Jules Insler has a background that's primarily military electronics-oriented. He's presently working toward completing a BSEE degree at the New York University.



Schlisser



Kressel

Nelson

Lockwood

**Three's not always** a crowd, especially when the trio teams up to produce a product like the semiconductor laser described in the article that begins on page 78. Vienna-born Henry Kressel, author of the article, has worked on avalanche and optical properties of p-n junctions at RCA. Last year, he was named chief of semiconductor optical devices research. He holds a Ph.D. from the University of Pennsylvania. Co-authors Herbert Nelson and Harry F. Lockwood pulled their share of the load, too. Nelson, who joined RCA in 1930, pioneered techniques for liquid-phase generation of epitaxial films that are employed in fabricating germanium tunnel diodes, injection lasers, and other semiconductors. Lockwood, who worked on semiconductors at General Telephone and Electronics Laboratories, joined RCA in 1969, where his specialty has been injection lasers.



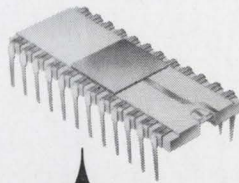

**one-package**

---

**MTOS  
counter  
display  
drivers**

**available in production quantities**



# General Instrument's new one-package MTOS counter display drivers replace conventional counter decoding and driving systems requiring at least 3 packages

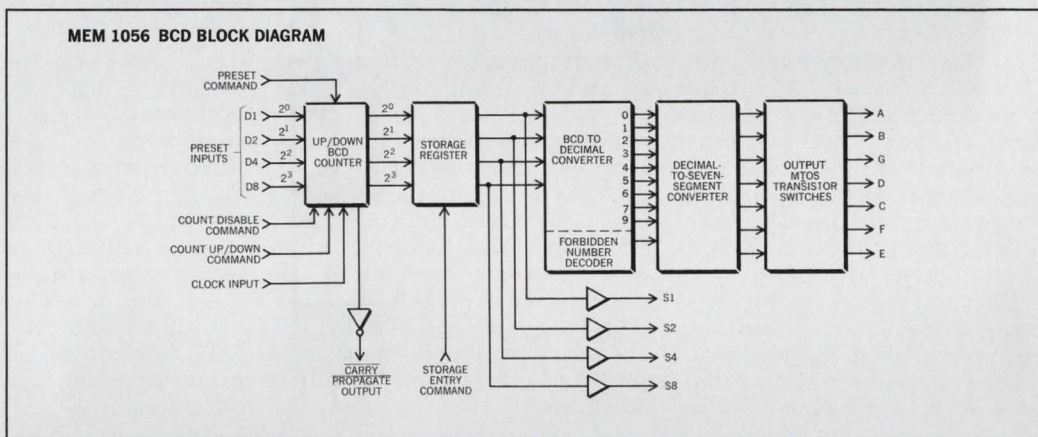
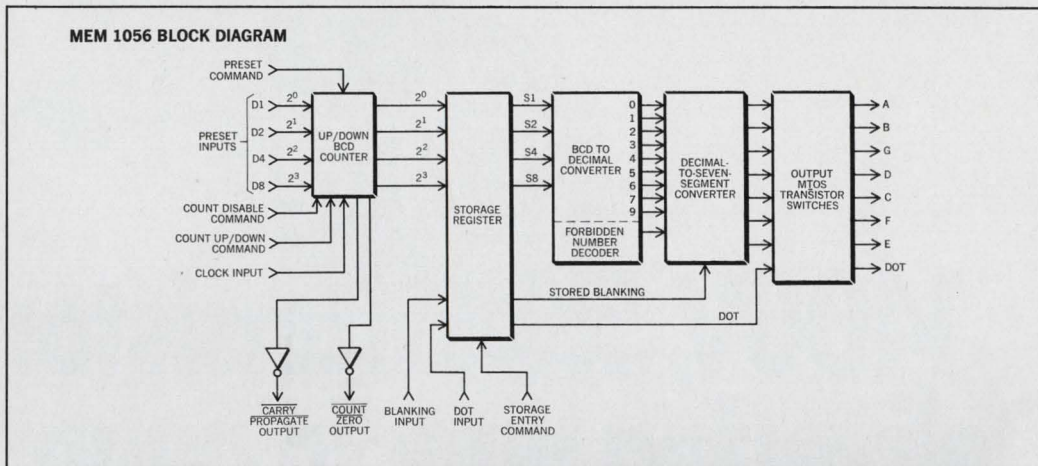

It takes only one MTOS MEM 1056 in one 24 lead dual in-line package to drive a seven segment fluorescent readout tube such as the DIGIVAC\* S/G.

Conventional IC counter decoder and driving systems require at least 3 packages to do the same job.

The elimination of the need for all but this single package means lower installation costs, lower PC board costs, less assembly and test time and, of course, higher reliability.

The MEM 1056 is an MTOS monolithic integrated circuit designed primarily to operate in conjunction with a seven segment fluorescent readout tube for displaying numeric information. It contains a one decade up-down BCD counter, a storage register, a BCD-to-seven segment decoding matrix and display drivers. The device features:

- Direct Display Drive Capability
- Low Power Consumption
- Count Zero Indication
- Decimal Point Indication
- False Code Indication
- Blanking Input

The up-down counter sections of the chips can be cascaded to form synchronous counting chains. Also, by utilizing external elements, asynchronous, one-megacycle, up-down counting can be achieved irrespective of the number of counter stages cascaded.

The description and features of the MEM 1056 BCD are basically the same as those of the MEM 1056 except that the BCD version has four BCD outputs.

Both the MEM 1056 and MEM 1056 BCDs are available from your authorized General Instrument Distributor. For full information write General Instrument Corporation, Dept. 56, 600 West John St., Hicksville, L. I., N. Y. 11802. (In Europe, write to General Instrument Europe S.P.A., Piazza Amendola 9, 20149 Milano, Italy; in the U.K., to General Instrument U.K., Ltd., Stonefield Way, Victoria Rd., South Ruislip, Middlesex, England.)

\*DIGIVAC is a registered trademark of Wagner Electric Corporation



GENERAL INSTRUMENT CORPORATION • 600 WEST JOHN STREET, HICKSVILLE, L. I., NEW YORK



# 1400V, 5.0A Transistors. Delivering now, in quantity.

The Kokomoans' new DTS 802 and 804 NPN triple diffused silicon high energy transistors are here. You can order them from your Delco Radio distributors now in sample or production quantities. They were specially designed for high voltage inductive switching from rectified 3 phase 220 line, and magnetic deflection circuits in large screen color TV receivers.

They've been application-tested from production lots by

prospective users with stringent reliability requirements. They do the job. And their energy handling capability is verified by Delco Pulse Energy Testing.

The high energy reliability of Delco silicon power transistors has earned them a reputation for survival in the toughest switching jobs. It's a built-in advantage, vitally important where circuits are subject to transients or fault conditions.

Now you can simplify the design of high energy circuits with reduced size, weight, and component cost. Convert HV tube circuits to solid state reliability without the complexity associated with high current, low voltage devices. And fewer components mean higher reliability.

For prices and delivery or additional data on Delco's new DTS 802 and 804 contact us or your nearest Delco Radio distributor.

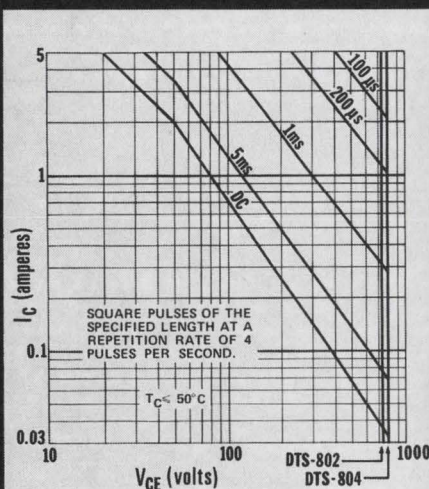

SAFE OPERATING CURVES

PARAMETER	DTS-802	DTS-804
Collector to emitter voltage ( $V_{CEX}$ )	1200V max.	1400V max.
Collector to emitter voltage ( $V_{CEO}$ )	1000V max.	1000V max.
Sustaining voltage ( $V_{CEO}$ sus)	750V min.	800V min.
Emitter to base voltage ( $V_{EBO}$ )	5V max.	5V max.
Collector current ( $I_C$ ) continuous	5A max.	5A max.
$h_{FE}$ , $I_C = 3.5A$ , $V_{CE} = 5V$	2.2 min.	2.2 min.
*P.E.T.; $I_C = 7A$ , $V_{CE} = 200V$ , $t_p = 300 \mu$ sec, duty cycle $< 4\%$		
	420 mJ min.	420 mJ min.

\*Pulse Energy Test

Available in solid copper JEDEC TO-3 package.



## From these Delco Semiconductor distributors.

ALA., BIRMINGHAM • Forbes Distributing Co., Inc. (205)-251-4104  
 ARIZ., PHOENIX • Sterling Electronics, Inc. (602)-258-4531  
 • Hyer/Cramer Electronics, Inc. (602)-263-1112  
 CAL., LOS ANGELES • Kierulff Electronics, Inc. (213)-685-5511  
 • Radio Products Sales, Inc. (213)-748-1271  
 CAL., PALO ALTO • Kierulff Electronics, Inc. (415)-968-6292  
 CAL., SAN DIEGO • Milo of California, Inc. (714)-232-8951  
 COLO., COLORADO SPRINGS • L. B. Walker Radio Co. (303)-636-1661  
 COLO., DENVER • L. B. Walker Radio Co. (303)-935-2406  
 • Hyer/Cramer Electronics Inc. (303)-758-2100  
 FLA., MIAMI • Mountain Electronics, Subsidiary of Avnet, Inc., (305)-634-4556  
 FLA., WEST PALM BEACH • Mountain Electronics, Subsidiary of Avnet, Inc., (305)-833-5701  
 ILL., ROSEMONT • F-J-R/Midwest, Inc. (312)-678-8560  
 ILL., SKOKIE • Merquip Electronics, Inc. (312)-282-5400  
 IND., INDIANAPOLIS • Graham Electronics Supply, Inc. (317)-634-8486  
 MD., BALTIMORE • Radio Electric Service Co. (301)-823-0070  
 MASS., NEWTON • The Greene Shaw Co., Inc. (617)-969-8900  
 MICH., KALAMAZOO • Electronic Supply Corp. (616)-381-4624  
 MICH., ROMULUS (Detroit) • Harvey Radio Co. (313)-729-5500  
 MINN., MINNEAPOLIS • Stark Electronics Supply Co. (612)-332-1325

MO., KANSAS CITY • Walters Radio Supply, Inc. (816)-531-7015  
 MO., NO. KANSAS CITY • ECI Semiconductors, Inc. (816)-221-2400  
 MO., ST. LOUIS • Electronic Components for Industry Co. (314)-647-5505  
 N.J., CLIFTON • Eastern Radio Corporation (201)-471-6600  
 N.M., ALBUQUERQUE • Hyer/Cramer Electronics Inc. (505)-265-5767  
 • Sterling Electronics Inc. (505)-247-2486  
 N.Y., BINGHAMTON • Federal Electronics, Inc. (607)-748-8211  
 N.Y., NEW YORK • Harvey Radio Co., Inc. (212)-582-2590  
 N.Y., WOODBURY, L.I. • Harvey Radio Company, Inc. (516)-921-8700  
 OHIO, CINCINNATI • United Radio, Inc. (513)-761-4030  
 OHIO, CLEVELAND • The W. M. Pattison Supply Co., Industrial Electronics Division (216)-441-3000  
 OHIO, DAYTON • F-J-R/Ohio, Inc. (513)-278-9411  
 OKLA., OKLAHOMA CITY • Radio, Inc. (405)-235-1551  
 OKLA., TULSA • Radio, Inc. (918)-587-9123

PENN., PHILADELPHIA • Almo Electronics, Division of Sterling Electronics (215)-676-6000  
 PENN., PITTSBURGH • RPC Electronics (412)-782-3770  
 S.C., COLUMBIA • Dixie Radio Supply Co., Inc. (803)-253-5333  
 TEXAS, DALLAS • Adleta Electronics Company (214)-742-8257  
 TEXAS, FORT WORTH • Adleta Electronics Co. (817)-336-7446  
 TEXAS, HOUSTON • Harrison Equipment Co., Inc. (713)-224-9131  
 UTAH, SALT LAKE CITY • Hyer/Cramer Electronics Inc. (801)-487-3681  
 VA., RICHMOND • Meridian Electronics, Inc., a Sterling Electronics Company (703)-353-6648  
 WASH., SEATTLE • Kierulff Electronics, Inc. (206)-763-1550  
 WASH., TACOMA • C & G Electronics Co. (206)-272-3181  
 CANADA, ONT., SCARBOROUGH • Lake Engineering Co., Ltd. (416)-751-5980

**Kokomoan's Regional Headquarters.** Union, New Jersey\* 07083, Box 1018 Chestnut Station, (201) 687-3770 ■ Santa Monica, Calif.\* 90401, 726 Santa Monica Blvd., (213) 870-8807 ■ Chicago, Illinois\* 60656, 5151 N. Harlem Avenue, (312) 775-5411 ■ Kokomo, Ind. 46901, 700 E. Firmin, (317) 459-2175 Home Office ■ \*Office includes field lab and resident engineer for application assistance.

**THE KOKOMOANS ARE IN POWER**  
**DELCO RADIO**  
 DIVISION OF GENERAL MOTORS  
 KOKOMO, INDIANA





# RCL SWITCH INFORMATION CENTER

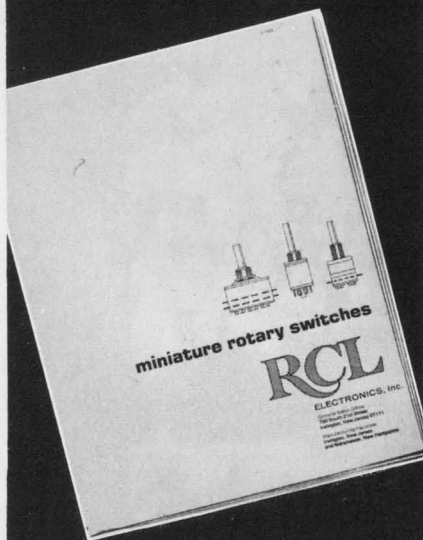

AN EASY-TO-READ  
NEWLY EXPANDED  
TECHNICAL CATALOG OF  
INDUSTRY'S MOST  
COMPLETE SELECTION  
OF  
**MINIATURE  
ROTARY  
SWITCHES**

WRITE FOR YOUR FREE COPY

# RCL

General Sales Office  
RCL ELECTRONICS, INC.  
700 South 21st Street  
Irvington, New Jersey 07111

## Who's Who in electronics



Allison and Baker

**The most direct** way to grab off a piece of the action in a particular area is simply to start your own company. But that route usually is strewn with entrepreneurial obstacles—among them financing and possible legal battles over rights to technology. A potentially smoother path is being taken by Orville Baker and David Allison, two Signetics Corp. originals: their newly formed Signetics Memory Systems will be under the same Corning Glass Works corporate umbrella as Signetics itself.

Baker, 37, will become president of Signetics Memory, while Allison, 34, will hold the vice president title. At Signetics, Baker was vice president in charge of corporate development and Allison was vice president heading up R&D.

**Family.** "We'll have a relationship with Signetics much the same as two sister divisions of the same company," Baker explained. The five-man board of directors is made up of Allison and Baker, with Signetics and Corning filling the remaining three seats.

With this type of working relationship Baker and Allison feel they have the best of both worlds: the independence, flexibility, and freedom to maneuver quickly in the exploding semiconductor memory market, while still maintaining the advantage of Signetics' R&D as well as memory chip design and production capabilities.

"The market for semiconductor memory bits is immense," says

Baker, "and a lot of the market is made up of people who want to buy memory systems instead of plug-ins. Signetics will do a great job designing and producing memory chips to meet the needs of plug-ins, but it doesn't have the systems type of talent necessary to compete successfully.

"Also," he adds, "when you have 50 people, it's difficult to get them moving fast enough to take advantage of the opportunities we see in the memory systems business."

Allison points to the ability of a young, small company like Signetics Memory to attract top talent from larger companies.

**Think small.** Baker and Allison want to keep the company small and agile, with about eight people making up the braintrust.

"We've got a lot of homework to do before all our goals are established," says Baker. He insists dollar figures in the memory system market aren't significant now because until at least 1975 the market will be "as large as pricing allows it to be."

**What's the Pentagon's** biggest problem? Some say it's the slings and arrows of Wisconsin Democrat William D. Proxmire, whose Senate assaults on the military-industrial complex have achieved near-legendary status. When Pentagon



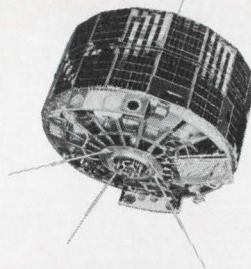

FROM

# Weather "Bird"

TO

# Tropo-scatter

**in one quick**

---

# frequency change

---

### MCL's 2-1/2-KW PLUG-IN CAVITY

Giving a big assist to the Department of Commerce's Satellite tracking command is MCL's 2.5KW plug-in amplifier, an integral part of the up-link command transmitter. This high-powered cavity unit supplies the signal power so vital to the telemetry communications of the ESSA Satellite (Environmental Survey Satellite) or the Weather Bird.

Adaptability to a wide range of frequencies gives the MCL amplifier system almost limitless applications in other command communication channels.

Tropo-Scatter, for example, is used by oil companies as a communications' link in the Sahara desert. Other applications include testing equipment for checking out antennae, laboratory and field testing.

A conference call to MCL engineers just might put you on the right wave length regarding your application needs.

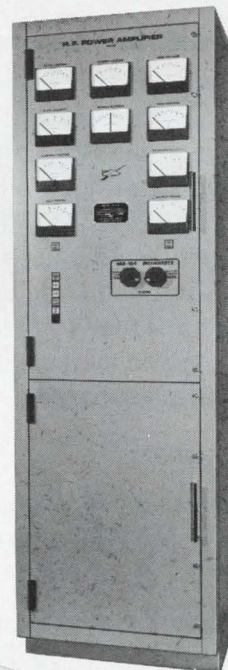

Call (312) 354-4350 or send for MICROWAVE MARKETPLACE CATALOG—Edition "A".



**MCL** MICROWAVE CAVITY LABORATORIES  
 DIVISION OF KMS INDUSTRIES, INC.  
 10 North Beach Avenue, LaGrange, Illinois 60525



# Sweep 5-2350 MHz with a single instrument



Price. \$2495.00

VS-90 sweep generator packs more range—more convenience—into one compact package. With no extra, plug-in heads needed. Three overlapping bands provide full sweep coverage from: 5-800 MHz; 750-1300 MHz; and 1250-2350 MHz. Each band can be swept to its full width and each has the stability required for narrow band circuit testing. Birdy-by-pass marker provides for up to seven single frequency or harmonic markers. External input takes CW source for variable marker.

## Basic Specifications:

**FREQUENCY RANGE:** 5.0 MHz to 2350 MHz in three overlapping bands.

**RF OUTPUT:** The RF output is at least 0.75v rms into a 50 ohm load.

**FLATNESS:** The flatness is  $\pm 0.5$  db at maximum sweep width (tested with a CD-51 detector).

**HARMONIC DISTORTION AND SPURIOUS AT RATED OUTPUT:**  
Band #1 from 10 MHz to 800 MHz-25 db below fundamental output.  
Band #2 40 db below fundamental output. Band #3 40 db below fundamental output.

*Texscan*



**Texscan Corporation**  
2446 N. Shadeland Ave.  
Indianapolis, Ind. 46219  
AC 317/357-8781

## Who's Who in electronics

program managers say they've been "Proxmired," there is no doubt in Washington as to their meaning.

But **Richard F. Kaufman** says that the Proxmire attacks are no more than an overdue reaction to a more fundamental Pentagon problem, one he defines as "a superabundance of money." At 35, the curly-haired, sideburned economist, a University of Texas law graduate, is close to the problem. As a senior staff man for the Joint Economic Committee, Kaufman dredges up the data that provides the Senator and the committee with the foundation for attacks on waste in the military establishment. "There is so much wrong at the Pentagon," contends Kaufman, "that one can almost close his eyes and point to come up with something."



**History.** In the past, Kaufman emphasizes, the military's simple solution to coping with program cost overruns was to get more money from Congress—something it could do without great difficulty. The services rarely took the harder course of searching out the problem and taking corrective action, he says. But the Congressional economist emphasizes that this is changing as more of Proxmire's colleagues start to share his view.

The actual purpose of the Joint Economic Committee, which was created as a counterpart to the President's Council of Economic Advisers under the Employment Act of 1946, is to advise Congress on the national economy. In the defense area, Kaufman's specialty since he joined the staff three years ago, the job is not to find problems in specific programs, but to take a broader view of the management of defense spending and its impact on the economy as a whole. But by exposing gross inefficiencies on particular programs, such as Proxmire's subcommittee on economy in government did on the C-5A and Mark 2 avionics programs, it is easier to prove waste.



- Four full digits plus "1" for 20% overranging
- Rechargeable battery operation optional
- Measures ac and dc volts in four ranges to 1200 volts
- Measures ohms in five ranges to twelve megohms
- Active 2 pole switchable filter
- Automatic polarity indicator
- All functions push-button selectable



## The digital multimeter you can believe

**Announcing the Fluke 8100A, a completely portable 0.02% digital multimeter for \$695.**

The only way to build a multimeter with no last digit uncertainty is to add an "extra digit." That's exactly what we've done with the new Fluke 8100A. Here is an instrument with nine times the accuracy of three digit units selling at only half the price of comparable four digit multimeters.

How?

We've used an A to D conversion technique new to the DVM field. The result is an instrument with low power drain, simplicity of circuitry, troublefree oper-

ation and the uncommon accuracy you expect from Fluke.

Standard features include ac measurement accuracy of 0.2% and resistance, 0.1%. For real portability, batteries will operate the multimeter continuously up to eight hours without recharging. Battery operation, the only option, is priced at \$100. Accessories available include high frequency and voltage probes, switched ac-dc current shunts and a ruggedized case.

# FLUKE

Fluke, Box 7428, Seattle, Washington 98133. Phone: (206) 774-2211. TWX: 910-449-2850. In Europe, address Fluke Nederland (N.V.), P.O. Box 5053, Tilburg, Holland. Phone: (04250) 70130. Telex: 884-50237. In the U. K., address Fluke International Corp., Garnett Close, Watford, WD2 4TT. Phone: Watford, 27769. Telex: 934583.

See us at IEEE 2C02-2C04



# TI's quiet revolution in TTL/MSI

**SN54/74180**  
8-Bit Parity Generator/Checker

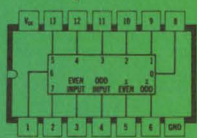

**SN54/74151**  
8-Bit Data Selector

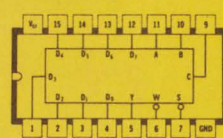

**SN54/74152**  
8-Bit Data Selector

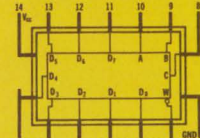

**SN54/74150**  
16-Bit Data Selector

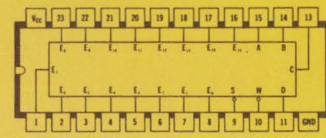

**SN54/74153**  
Dual 4-to-1-line Data Selector

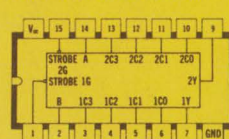

**SN54/7490**  
Decade Counter

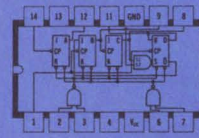

**SN54/7477**  
Quad Bistable Latch

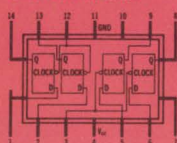

**SN54/7481**  
16-Bit Random-Access Memory

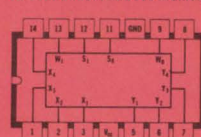

**SN54/7492**  
Divide-by-12 Counter

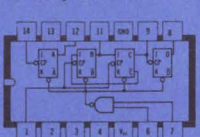

**SN54/7493**  
4-Bit Binary Counter

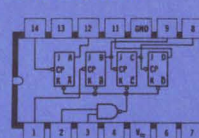

**SN54/74192** Synchronous  
Up/Down Decade Counter

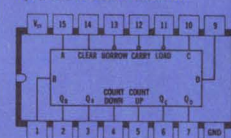

**SN54/7475**  
Quad Bistable Latch

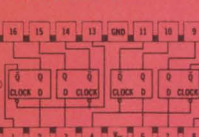

**SN54/7484**  
16-Bit Random-Access Memory

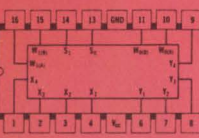

**SN7488**  
256-Bit Read-Only Memory

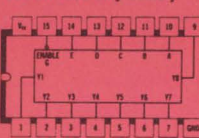

**SN54/74100**  
Dual Quad Bistable Latch

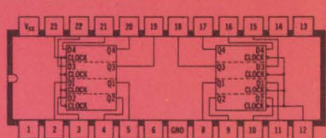

**SN54/74L93**  
4-Bit Binary Counter

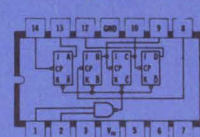

**SN54/74193** Synchronous  
Up/Down Binary Counter

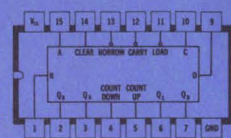

**SN54/74L95**  
4-Bit Universal Shift Register

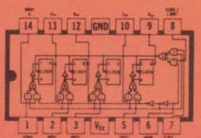

**SN54/7496** 5-Bit Shift  
Register (Dual Parallel-In, Out)

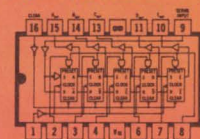

**SN54/7491A**  
8-Bit Shift Register

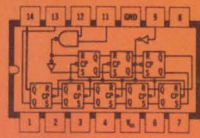

**SN74141**  
BCD-to-Decimal Decoder/Driver

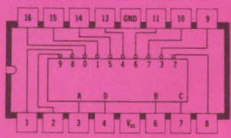

**SN54/7494** 4-Bit Shift  
Register (Parallel-In, Serial-Out)

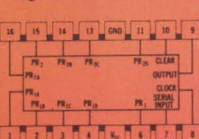

**SN54/7495**  
4-Bit Universal Shift Register

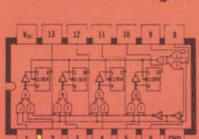

**SN54/74L91**  
8-Bit Shift Register

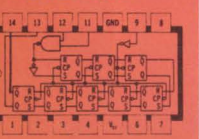

**SN54/74L98**  
4-Bit Data Selector/Storage Register

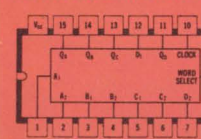

**SN54/74L99**  
4-Bit Universal Shift Register

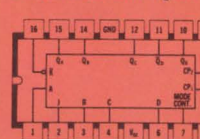

**SN54/7442**  
BCD-to-Decimal Decoder

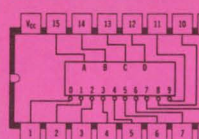

**SN54/7443**  
Excess-3-to-Decimal Decoder

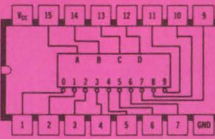

**SN54/7444**  
Excess-3-Ray-to-Decimal Decoder

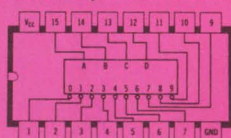

**SN54/7480**  
Gated Full Adder

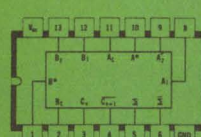

**SN54/7482**  
2-Bit Binary Full Adder

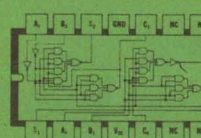

**SN54/7483**  
4-Bit Binary Full Adder

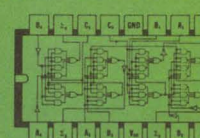

**SN54/7445/145**  
BCD-to-Decimal Decoders/Drivers

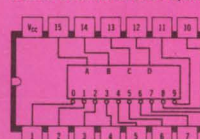

**SN54/74154**  
4-to-16-line Decoder/Demultiplexer



**SN54/7486** Quad  
2-Input Exclusive-OR Element

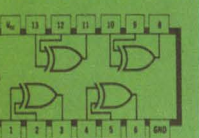

**SN54/74L86** Quad  
2-Input Exclusive-OR Element

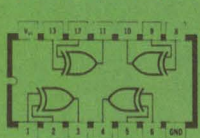

**SN54/74H87**  
4-Bit True/Complement Element

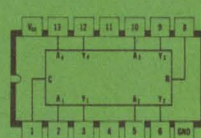

**SN54/7446/47**  
BCD-to-7-Segment Decoders/Drivers

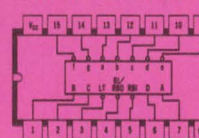

**SN54/7448**  
BCD-to-7-Segment Decoder/Driver

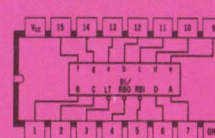

**SN54/7449**  
BCD-to-7-Segment Decoder/Driver

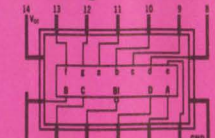

**SN54/74L85**  
4-Bit Magnitude Comparator

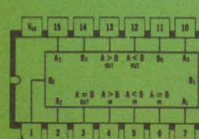

**SN54/74182** Look-Ahead  
for Arithmetic Logic Unit

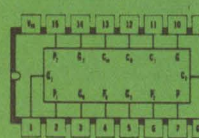

**SN54/74H183**  
Dual Carry-Save Full Adder

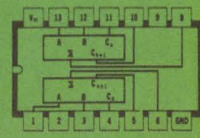

**SN54/74181** 4-Bit Arithmetic Logic Unit  
(ALU)/Function Generator

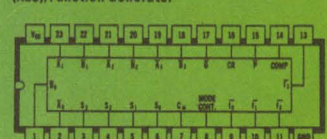

**SN54/74155/156** Dual  
2-to-4-line Decoders/Demultiplexers

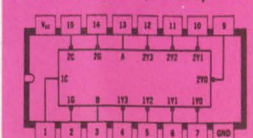



# Take a realistic look at MSI. Compare the choice of functions. Compare circuit complexity. Compare availability. Compare price.

(Then you'll know why more of TI's 54/74 MSI  
is second-sourced by second sourcers.)

Start your comparison with the left-hand page.

**FACT:** You see that TI lays 48 separate, distinct MSI functions on the line—your broadest choice by far. **4 data selectors/multiplexers, 13 decoders, 6 memories/latches, 8 shift registers, a parity generator, 6 counters and 10 arithmetic elements.**

No numbers game this. We're talking basics—not every variation made possible by a choice of two temperature ranges and three package styles.

**FACT:** More complexity—more performance—is packed into Series 54/74 MSI packages. The average com-

plexity of TI's MSI line is more than 30 gates—an order of magnitude higher than competitive TTL/SSI lines. So when you want **all** the benefits of MSI, come to where not only the choice is wider but also the overall complexity is greater.

**FACT:** Availability is unequalled. Huge in-house inventories (averaging more than 100,000 MSI parts) are maintained in all packages—plastic and ceramic DIP and flat pack—and in both temperature ranges.

**FACT:** Prices are low. TI has been committed to MSI price leadership since we introduced the first one in 1967. We've made more MSI than

anyone... and it's manufacturing know-how and high yields that keep TI costs, and prices, consistently low.

**Make yours a tough comparison** on us and our competition. For facts on our availability and prices, call your TI salesman or authorized TI Distributor. To compare choice and complexity, get the 184-page supplement to our TTL catalog. It'll bring you up-to-date on our 48 MSI functions. Circle 286 on the Reader Service Card or write Texas Instruments Incorporated, P.O. Box 5012, M. S. 308, Dallas, Texas 75222. That's where the quiet MSI revolution is going on.



**TEXAS INSTRUMENTS**  
INCORPORATED



# Introducing The Electronics Network.

## Channel 1: Sells the decision-making market.

Electronics is the worldwide electronics marketing channel. Use it to build a market position for your products. To create acceptance for your advanced technology. Or simply to sell ideas.

Many of Electronics 81,000 subscribers cannot be reached through any other publication. Sixty-seven per cent buy anywhere from \$10,000 to over \$1,000,000 worth of products each year. And many of them never see salesmen.

40 skilled editors located in the key market areas and an annual editorial budget in excess of \$1,000,000 provide Electronics readers with broadband technical information to help them do their jobs better.

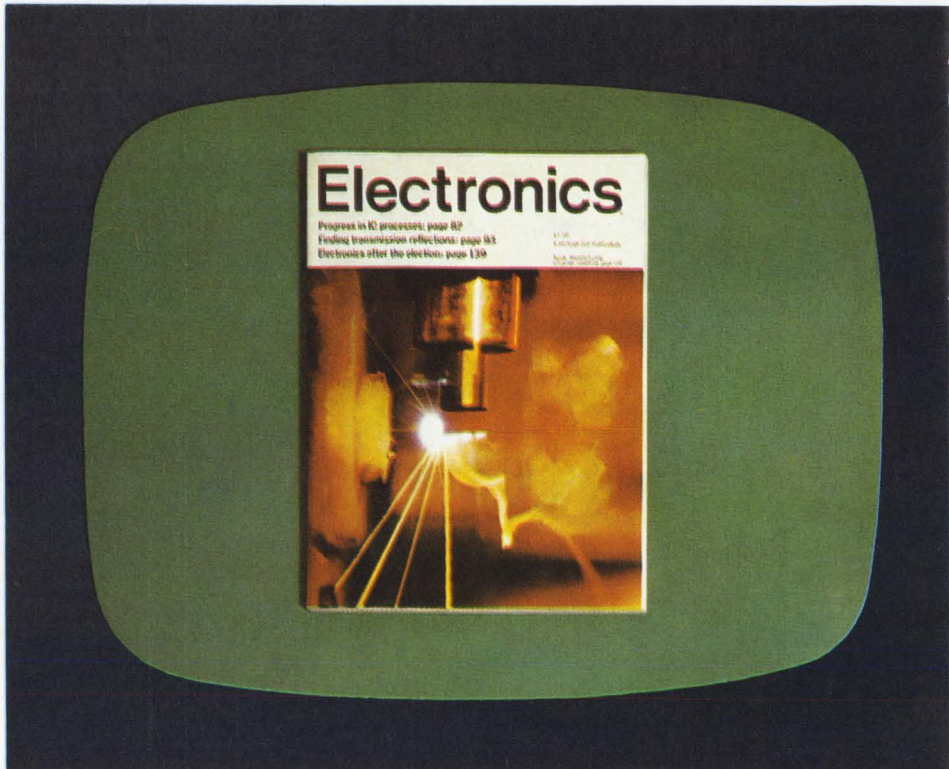

## Channel 2: Covers the mass market.

Electronics New Product Preview is the low-cost, mass-coverage channel to the U.S. market (where approximately 70% of the worldwide market is located). Use it as cooperative direct mail to merchandise off-the-shelf products, promote established low profit-margin items. Or use it to generate quick inquiries for your catalogs and specification sheets. (Our first issue produced over 50,000 inquiries.)

ENPP reaches 100,000 U.S. recipients (without duplicating the circulation of Electronics). It publishes more new-product information than any other electronics publication and presents it in ten product sections.





Four channels  
designed to work together  
to make your  
advertising budget  
go farther.

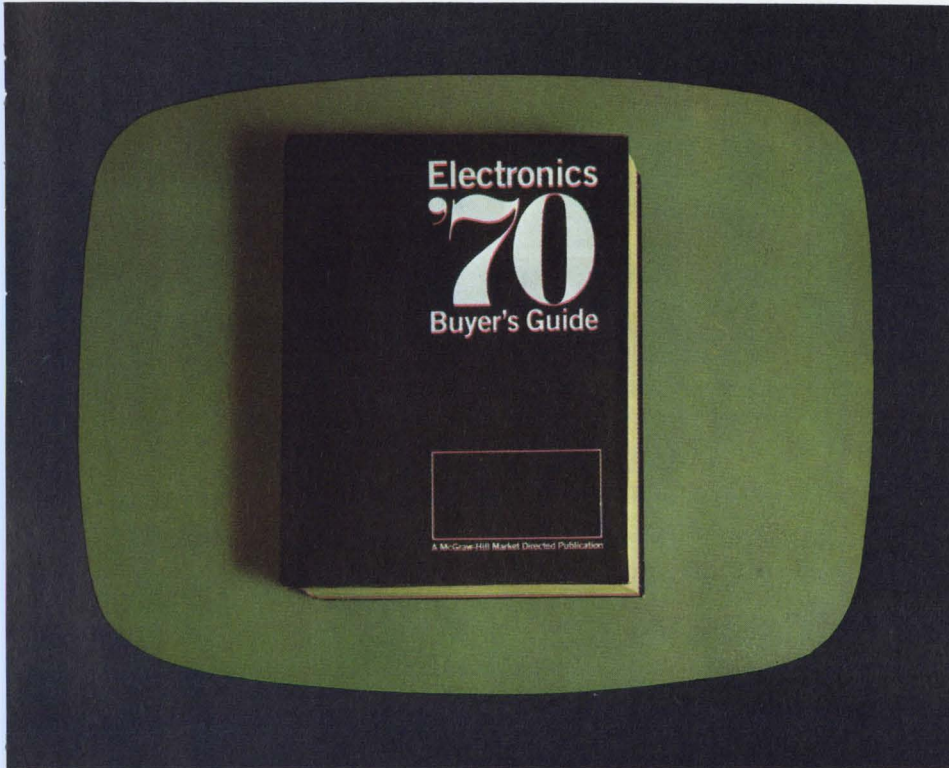

**Channel 3:**  
**Reaches the ready-to-buy market.**

Electronics Buyers' Guide is the channel to use for reaching customers who are actively seeking sources of supply. EBG goes to 85,000 engineers and purchasing men, but is used by more than 375,000 of them. (It's borrowed a lot.) The "yellow pages" gives the buyers all the information they need in one reference: sources, product and advertisements. Prime users tell us they prefer EBG two to one over all other directories, catalogs and registers because it is so complete and easy to use.



**Channel 4:**  
**Provides custom marketing services.**

Electronics/Management Center can develop a customized information program to help you reach your markets. It can probe market potentials, test new product ideas, improve old products, even design a complete marketing strategy.

Electronics/Management Center has the people and facilities to provide you with custom-information in the areas of management, marketing and engineering consultation.

Write for the E/MC brochure, "A full-circle information resource."

*The Electronics Network.*  
*A market-directed communications*  
*service from McGraw-Hill.*  
*Electronics. Electronics New Product Preview.*  
*Electronics Buyers' Guide.*  
*Electronics/Management Center.*  
330 West 42nd Street, New York, N.Y. 10036.



# BULOVA Crystal Oscillators with high stability over extended temperature ranges

Now Bulova has available Temperature Compensated and High Stability Crystal Oscillators that are uniquely designed for increased performance capability.

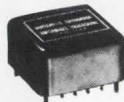

## TEMPERATURE COMPENSATED CRYSTAL OSCILLATOR

TCXO-30

Frequency Stability:

$\pm 5\text{pp} 10^7$  over temperature range of  $-55^\circ\text{C}$  to  $+85^\circ\text{C}$ .

Employs a computer-selected-and-optimized compensation network designed to maintain frequency stability over wide temperature ranges without the need for an oven ( $\pm 0.5\text{PPM}$  from  $-55^\circ\text{C}$  to  $+85^\circ\text{C}$ ). Operating over a frequency range of 3MHz to 5MHz, it consumes only 50MW and is just four-cubic-inches. Aging rate is 1.0pp  $10^8$  per week.



## HIGH STABILITY CRYSTAL OSCILLATOR

PCOXO-101

Frequency Stability:

$\pm 1.0\text{PP} 10^8$  over temperature range of  $-55^\circ\text{C}$  to  $+70^\circ\text{C}$

Within a plug-in package is a high precision crystal and an oscillator circuit with AGC to maintain low constant crystal drive in a stable DC proportional control oven. The result is a crystal oscillator of unusual high frequency stability ( $\pm 1.0\text{PP} 10^8$  from  $-55^\circ\text{C}$  to  $+70^\circ\text{C}$ ), a short term stability of  $1\text{PP} 10^{10}$  per second, an aging rate of  $1\text{PP} 10^9$  per day and with a frequency output of 1.0 or 5.0 MHz.

If you have a crystal oscillator problem that needs solving, call (212) 335-6000, see EEM section 2300, or write —



**BULOVA**  
FREQUENCY  
CONTROL PRODUCTS

Electronics Division of Bulova Watch Co., Inc.  
61-20 Woodside Ave., Woodside, N. Y. 11377

## Meetings

### Cops and robbers—and engineers

Getting the engineer, who may be expert in a military program, to relate to the needs of police departments during the design and product-planning phases of a law-enforcement system, is a prime objective of the Justice Department's third annual Symposium on Law Enforcement Science and Technology, to be held March 31 through April 2 at Chicago's Conrad Hilton Hotel. To this end, four workshop sessions have been added to the symposium's program this year, including one on information-systems planning and implementation in the case of criminal-justice systems.

The workshops are included in seven sessions, the first of which deals with the Law Enforcement Assistance Administration's (LEAA) National Institute of Law Enforcement and Criminal Justice, LEAA's research arm. The second session includes a discussion of communications technology, with industry and government experts speaking on spectrum requirements of police in metropolitan areas, new portable-radio systems, and "A Look into the Future Police Communications," by Walter Key of the National Institute.

Other sessions will treat crime-information systems, investigative-support technology, command and control technology, police-operations research, and criminalistics and support technology.

**Night sight.** A second-day panel on investigative-support technology

includes a speech by R.G. Stouder of RCA Electronics Components on the use of night-surveillance systems, and an evaluation of automatic license-plate-scanning systems by Brian Keenan and Kenneth Kerin of the Illinois Institute of Technology Research Institute (IITRI).

A command and control technology session on April 2 schedules Claud T. Smith of Univac for a talk on computerized national law-enforcement communications systems, and North American Rockwell's Robert J. Rieder on a systems-analysis view of police information-communications networks.

The last speech scheduled for the last day, by Robert Hand of IITRI on applications of aerospace technology to law-enforcement problems, should provide an incentive for aerospace engineers to stay through the final session on criminalistics and support technology.

IITRI—which is managing the symposium for the Justice Department—says that, while design engineers and product planners will benefit most from the workshops, engineers in specialty fields would do best in the technical sessions, where speakers will discuss everything from night-surveillance systems and extensive national communications networks to the system of matching grants used by LEAA.

For further information, contact S.I. Cohn, IITRI, 10 W. 35th St., Chicago 60616

## Calendar

**Symposium on Management and Economics in the Electronics Industry**, IEE; University of Edinburgh, Scotland, **March 17-20, 1970.**

**International Convention, IEEE**; New York Hilton Hotel and the New York Coliseum, **March 23-26, 1970.**

**Meeting of the Association for the Advancement of Medical**

**Instrumentation**, Statler Hilton Hotel, Boston, **Mar. 23-25, 1970.**

**Symposium on Submillimeter Waves**, IEEE, Polytechnic Institute, Brooklyn, New York, **March 31-April 2, 1970.**

**Communications Satellite Systems Conference**, American Institute of

(Continued on p. 25)





Heads: You win.

Tails: You win again.

Elco rack-and-panel connectors give you a better head start.

And a choice of tails.

The head start is the connecting end of an Elco connector: the patented Varicon™ contact that fully meets the requirements of MIL-E-5400. The four mating surfaces of this unique contact are coined to an exceptional hardness and wipe clean with each make. Once the contacts are joined, the inherent springiness of the gold/nickel-plated phosphor bronze and the fork-like design make a superior, gas-tight fit.

Because the contacts are free floating, they align perfectly. A few contacts or 100 or more, all fit precisely together every time, over a long service life. There's no contact chatter. Nobody else gives you a contact head quite like the Varicon.

And nobody else gives you the choice of tails you get with Varicon. You can wire-wrap, crimp, clip, stake, or solder them. Whatever terminating technique or combination of techniques your assembly lines are set up for, we'll furnish the appropriate tail. If staking or crimping is your style, we

can supply the equipment too. Manual or automatic. Purchase or lease.

Elco rack-and-panel connectors come in standard rectangular models, or as miniature connectors, or in modular units. You can have them with 2 Varicon contacts, or up to 140, or anything in between.

In short, our line of Varicon rack-and-panel connectors has a lot going for it. Except price. Though it's a precision component, the Varicon contact is easily produced in high speed progressive dies. There's no expensive machining, no waste. When you can turn out millions of Varicons a week, you don't have to charge a fortune for them.

There's a lot more to be told about Varicon connectors. It's all in our 28-page rack-and-panel connector guide, and we'll be happy to send you a copy. Just write, wire, call, or TWX us. Elco Corporation, Willow Grove, Pa. 19090. (215) 659-7000. TWX 510-665-5573.

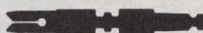

.078" Taper Tab



Solder/.098" Taper Tab



Wire Wrap Tail  
.024" x .050" x .567"



Wire Wrap Tail  
.024" x .050" x .760"



Crimp (Loose contact)

**ELCO** Rack-and-Panel  
Connectors

See us at NEPCON Central Booth 215



# INTRODUCING



## The instrument that obsoletes systems.

Simple idea. But someone had to think of it first. We did. We took all the elements of a digital data acquisition system and designed them as plug-in modules. Then we put them all in a box—*one box*. Result: the system became a single instrument.

So what? Cimron's new 8000 Series Digital Data Acquisition System is the first major departure in design concept since the advent of analog-to-digital converters. This new instrument optimizes the digital system. It offers the greatest

range of inputs, speed, and recording capability obtainable—*all at a price no system can match*. Cimron's measuring instruments will meet any accuracy and resolution requirement.

Modules in the single small 50-lb box include scanners, comparators, programmers, serializers, digital clock. No cables. No redundant components. Eliminates noisy ground loop problems. The housing contains a time shared readout, common power supply, and front panel con-

trols. The DAS 8000 is easily expandable and computer compatible.

Cimron *customer concern* again brings you a new instrument for solving the most stringent and complex measurement problems at the lowest cost per channel. For details on the DAS 8000, write: Cimron, Dept. D-132, 1152 Morena, San Diego, California 92110.

# CIMRON



CIMRON DIVISION

LEAR SIEGLER, INC.



## Meetings

(Continued from p. 22)

**Aeronautics and Astronautics;**  
International Hotel, Los Angeles,  
April 6-8, 1970.

**Joint Railroad Conference, IEEE;**  
Sheraton Hotel, Philadelphia,  
April 7-8.

**Reliability Physics Symposium, IEEE;**  
Stardust Hotel and Country Club,  
Las Vegas, Nevada, April 7-9, 1970.

**Meeting and Technical Conference,**  
Numerical Control Society; Statler  
Hilton, Boston, April 8-10, 1970.

**Computer Graphics International  
Symposium, IEE;** Uxbridge, Middlesex,  
England, April 13-16, 1970.

**International Geoscience Electronics  
Symposium, IEEE;** Marriott Twin Bridges  
Motor Hotel, Washington, April 14-17,  
1970.

**Semiconductor Packaging in the 1970's,**  
Polytechnic Institute of Brooklyn; Park  
Sheraton Hotel, New York, April 16-17.

**USNC/URSI-IEEE Spring Meeting;**  
Statler Hilton Hotel, Washington,  
April 16-19.

**American Power Conference, IEEE;**  
Sherman House, Chicago, April 21-23,  
1970.

**International Magnetics Conference  
(INTERMAG), IEEE;** Statler Hilton Hotel,  
Washington, April 21-24, 1970.

**Southwestern IEEE Conference &  
Exhibition;** Memorial Auditorium,  
Dallas, April 22-24.

**Annual Frequency Control Symposium,**  
U.S. Army Electronics Command;  
Shelburne Hotel, Atlantic City, N.J.,  
April 27-29, 1970.

**National Telemetry Conference,**  
IEEE; Statler Hilton Hotel, Los Angeles,  
April 27-30, 1970.

**National Relay Conference, Oklahoma  
State University and the National  
Association of Relay Manufacturers;**  
Oklahoma State University, Stillwater,  
April 28-29, 1970.

**Transducer Conference, IEEE;**  
National Bureau of Standards,  
Washington, May 4-6, 1970.

**Aerospace Power Conditioning Special-  
ists Conference, IEEE;** Royal Pines Mo-  
tel, NASA, Greenbelt, Md., April 20-21.  
**Industrial and Commercial Power Sys-  
tems and Electric Space Heating & Air  
Conditioning Joint Technical Confer-**

(Continued on p. 27)

# Soliton RF Power

*Covers the Spectrum!*

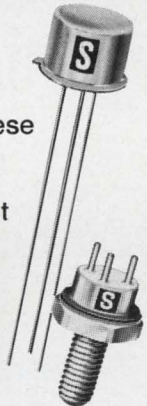
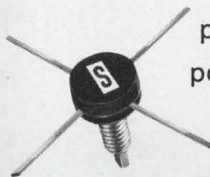

Soliton's wide range of RF power transistors can provide the right devices for your required applications. These transistors cover a useful frequency range from 30 to 1.2 GHz and output power levels of 1 to 60 Watts. All popular package types are available.

Take your pick from Soliton's power frequency spectrum and contact us today.

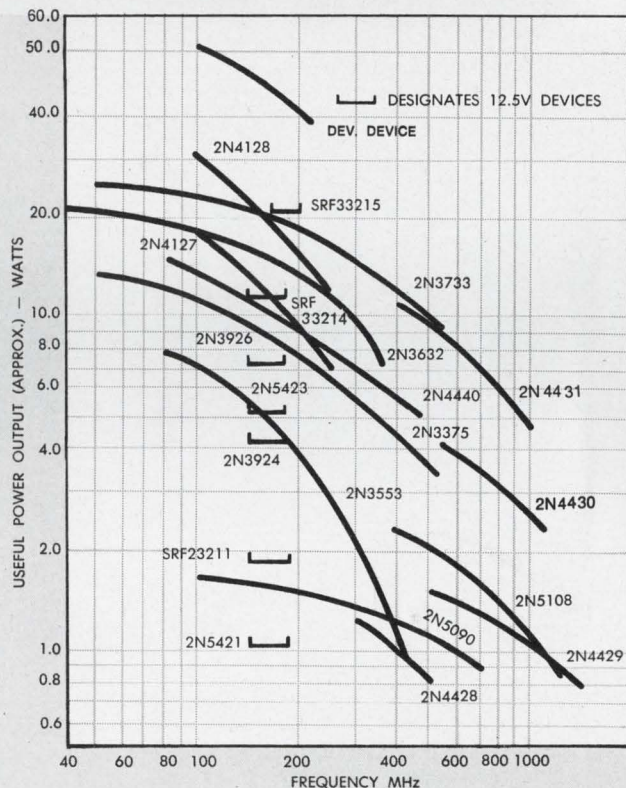

Dial 1-800-327-3243 for a "No Charge" telephone call and further information

# Soliton

## DEVICES, INC.

1177 BLUE HERON BLVD. / RIVIERA BEACH, FLA. / (305) 848-4311 / TWX: (510) 952-6676



# Only one man in a thousand needs the tracking speed of this synchro-to-digital conversion system...

(the other 999 sleep nights knowing it's there)

Continuously tracks 10 channels of resolver and synchro data to 20,000°/sec.

Ratiometric conversion and solid-state AC switching minimize harmonic and quadrature errors, yield 0.1° accuracy.

Control multiplexer selects one of 30 channels for real-time viewing. Formatting and timing logic adaptable to digital tape recorder or computer.

Modular building-block approach provides 60 Hz and 400 Hz conversion at 11.8V, 26V, and 90V line-line voltages.

High-speed tracking coupled with velocity constant of 20,000 seconds<sup>-1</sup> minimizes velocity errors.

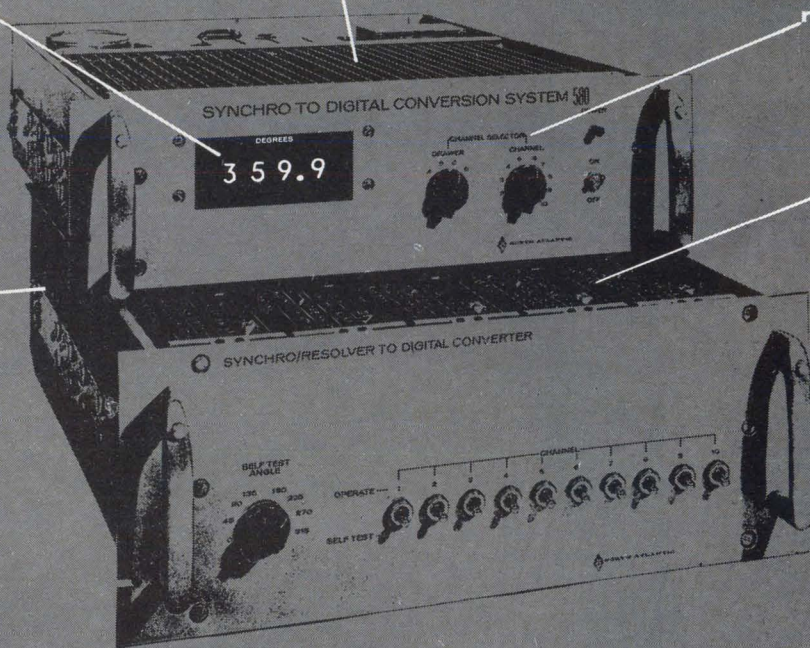

North Atlantic System 580 is available in a standard panel-mounting rack. Optional models offer higher accuracy and increased resolution or tracking speed. Each drawer accommodates up to 10 modules.

This low-cost data-acquisition system is another elegant example of North Atlantic's creativity in automatic test equipment, resolver/synchro instrumentation, and computer interface equipment.

For additional, rewarding details call our field-engineering representative (see EEM), use the reply card, or call or write North Atlantic Industries, Inc., Terminal Drive, Plainview, Long Island, N.Y. 11803. (516) 681-8600.

 **NORTH ATLANTIC**  
industries, inc.



## Meetings

(Continued from p. 25)

ence, IEEE; Jack Tar Hotel, San Francisco, May 4-7.

**Safety in Research and Development**, National Safety Council and the American Society of Safety Engineers; Cambridge, Mass., May 4-5.

**National Appliance Technical Conference**, IEEE; Leland Motor Hotel, Mansfield, Ohio, May 5-6, 1970.

**Spring Joint Computer Conference**, IEEE; Convention Hall, Atlantic City, N.J., May 5-7.

**Midwest Symposium on Circuit Theory**, IEEE and the University of Minnesota; University of Minnesota, Minneapolis, May 7-8.

## Short courses

**Computer-Aided Automation—The Evolution of**, Department of Engineering, University Extension; University of Wisconsin, May 5-6. \$70 fee.

**Eighth Annual Seminar on Solid State**, Department of Engineering, University Extension; University of Wisconsin, May 12-13. \$70 fee.

**Research and Development**, Department of Engineering, University Extension; University of Wisconsin, May 14-15. \$70 fee.

## Call for papers

**Symposium on switching and Automata Theory**, IEEE; Santa Monica Calif., Oct. 28-30. May 15 is deadline for submission of abstracts to Professor Peter Weiner, Department of Computer Science, Dunham Laboratory, Yale University, New Haven, Conn. 06520.

**Conference on Engineering in Medicine and Biology**, Alliance for Engineering in Medicine and Biology; Nov. 15-19. June 1 is deadline for submission of abstracts to William T. Maloney, Conference Coordinator, 1970 ACEMB, 6 Beacon St., Suite 620, Boston, Mass. 02108.

**International Symposium on Circuit Theory**, IEEE; Sheraton-Biltmore Hotel, Atlanta, Georgia, Dec. 14-16. June 1 is deadline for submission of abstracts to I.T. Frisch, Network Analysis Corp., Beechwood, Old Tappan Road, Glen Cove, N.Y. 11542

# THE New GENERATION SCR

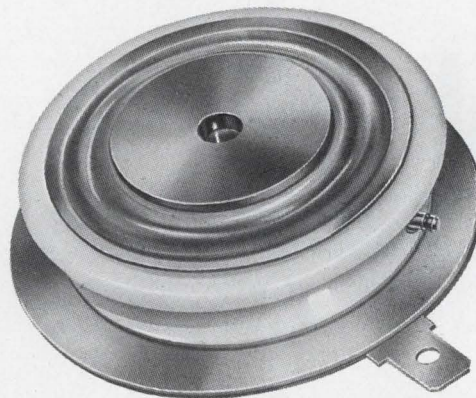

## DISC PACKAGED REGENERATIVE GATE SCR's

Operation to 20 KHz with low switching losses  
⊕ di/dt capability to 800 A/μsec. ⊕ low power gate drive ⊕ dv/dt capability to 500 V/μsec.  
⊕ 175 and 370 amperes RMS ⊕ turn-off time capability to 10 μsec. ⊕ also available in stud type package to 470 amperes RMS.

For additional information and application assistance, write or call National Electronics, Inc., a varian subsidiary, Geneva, Ill. 60134, phone (312) 232-4300.

## NATIONAL ELECTRONICS, INC.

a varian subsidiary

1969 COMPETITION WINNER  
Cited by Industrial Research Inc.  
as one of the 100 most  
significant technical products of the year.



A NATIONAL® exclusive.  
Patent #3,486,088



Nobody-  
but  
nobody...

*- where the priceless ingredient is care!*





- assures T<sup>2</sup>L deliveries
- offers as many T<sup>2</sup>L functions
- is a source for more T<sup>2</sup>L types

nobody but **Motorola.**

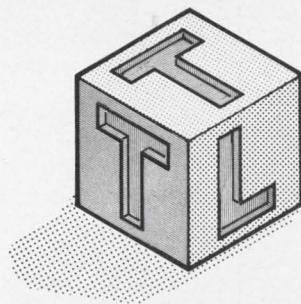

Building Block  
of Digital Circuitry

**MOTOROLA** Integrated Circuits



ELECTRONIC MATERIALS

DOW CORNING®  
**3140** RTV  
coating

clear, flowable silicone rubber coating;  
non-corrosive to copper and other metals  
TWO OUNCES

DOW CORNING

ELECTRONIC MATERIALS

DOW CORNING®  
**3140** RTV  
coating

clear, flowable silicone rubber coating;  
non-corrosive to copper and other metals  
TWO OUNCES

DOW CORNING®  
**3141** RTV  
coating

WHITE, FLOWABLE SILICONE RUBBER COATING;  
NON-CORROSIVE TO COPPER AND OTHER METALS

DOW CORNING

DOW CORNING®  
**3141** RTV  
coating

WHITE, FLOWABLE SILICONE RUBBER COATING;  
NON-CORROSIVE TO COPPER AND OTHER METALS  
NET WT. 2 oz/57 g

DOW CORNING®  
**3144** RTV  
adhesive/sealant

TRANSLUCENT, ROOM-TEMPERATURE-CURING  
SILICONE RUBBER ADHESIVE SEALANT;  
NON-CORROSIVE TO COPPER AND OTHER METALS  
NET WT. 2 oz/57 g

DOW CORNING

DOW CORNING®  
**3144** RTV  
adhesive/sealant

TRANSLUCENT, ROOM-TEMPERATURE-CURING  
SILICONE RUBBER ADHESIVE SEALANT;  
NON-CORROSIVE TO COPPER AND OTHER METALS  
NET WT. 2 oz/57 g

ELECTRONIC MATERIALS

DOW CORNING®  
**3145** RTV  
adhesive/sealant

grey, non-slump silicone rubber sealant;  
non-corrosive to copper and other metals  
TWO OUNCES

DOW CORNING®  
**3145** RTV  
adhesive/sealant

grey, non-slump silicone rubber sealant;  
non-corrosive to copper and other metals  
TWO OUNCES





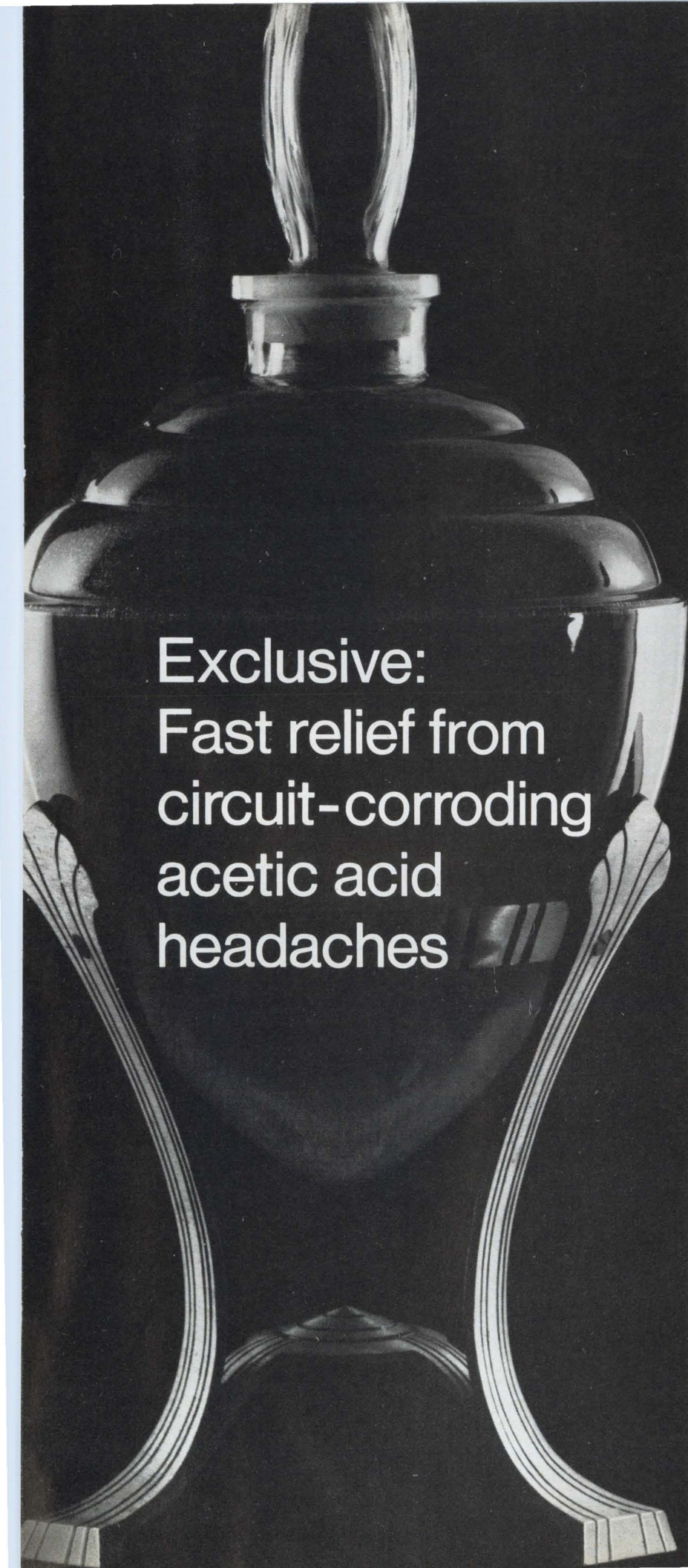

**Exclusive:  
Fast relief from  
circuit-corroding  
acetic acid  
headaches**

Dow Corning® silicone sealants and protective coatings are the only ones that do *not* release acetic acid or other corrosive by-products during cure. They were specifically developed to protect delicate circuit boards and other electronic components from corrosion, dust, dirt, abrasive particles, solvents and chemicals. They are strong, have excellent bond strength, electrical strength; are easy to apply, and cure quickly. There's no "vinegar" smell, either. Dow Corning 3140 (clear) and 3141 (opaque) RTV coatings are ready-to-use silicone rubbers that cure at room temperature. They are ideal for conformal coatings on printed circuit assemblies or for encapsulating small circuits or connectors. Dow Corning 3144 (clear) and 3145 (opaque) RTV adhesive/sealants are high-strength, non-corrosive, nonflowing silicone rubbers used to bond components and seal housings and connectors.

Stop component corrosion with these Dow Corning coatings and sealants. For more information, write Dow Corning Corporation, Dept. D-9342, Midland, Michigan 48640.

*Electrical / Electronic  
materials from*

**DOW CORNING**

DOW CORNING

Circle 31 on reader service card



# Mallory designed this DURACELL<sup>®</sup> for Bell & Howell

We met their battery needs. What can we do for you?

When Bell & Howell needed a "smaller but better" power source to operate their famous home movie cameras, they naturally turned to Mallory, makers of DURACELL, the amazing long distance power cell that far outlasts ordinary batteries. The result is our exclusive new HRA-2401, an improved High Rate Alkaline battery designed to withstand high drains for longer periods and to perform better at temperature extremes. The HRA-2401 is ideal also for powering the electric film drive on Bell & Howell's instant loading still cameras, another high drain use. Shown here is a typical performance curve of the HRA type.

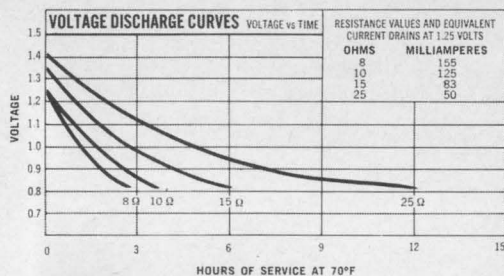

As a completely reliable and versatile battery, it very likely could be adaptable to your special needs.

In fact, we have many batteries that might be adaptable for you.

Either among our 1000-plus existing types of alkaline and mercury power cells. Or among our new, rechargeable alkaline series in D, C and AA, designed for selected applications.

If we don't have a battery for you, we'll design one. As we did for Bell & Howell.

For more information, write Technical Sales Department, Mallory Battery Company, a division of P. R. Mallory & Co. Inc., South Broadway, Tarrytown, New York 10591. Telephone: 914-591-7000.

(In Canada: Mallory Battery Company of Canada Limited, Sheridan Park, Ontario.)

It's good business to do business with Mallory

**MALLORY**





---

# Electronics Newsletter

---

March 16, 1970

**MOS needs may  
exceed supply ...**

There's a growing feeling that industry won't be able to meet the demand this year for MOS circuits. MOS sales in 1969, including custom work, ran between \$30 million and \$35 million; in 1970, the demand will be "in excess of \$100 million," predicts Charles Phipps, Texas Instruments' logic and memory functions manager.

But despite the multitude of new companies entering the field and major commitments from industry leaders like TI, Phipps doubts that industry can satisfy the demand. He estimates 1970 shipments will be "more like in the \$70 million to \$80 million range."

How well the industry does in shipping MOS this year will have an impact on sales in future years. "If we can't meet the demand, it will have negative impact on 1971-1972 sales," Phipps says. "But if we can come close to the 1970 demand, in three or four years MOS sales will be well in excess of \$200 million," he predicts.

Optimistic forecast for the MOS market aren't new, but now there's one new ingredient: the big three, Fairchild, Motorola, and TI. Many observers have long felt that the MOS market wouldn't really start moving until the big three really commit themselves. And now it's happening. National Semiconductor, which is the largest MOS supplier now, figures the big three, which are not among the front-running suppliers presently, will have major positions in MOS in two years.

**... as TI goes ahead  
on all processes ...**

Though Texas Instruments made its MOS decision back in 1967, the firm has been in the marketplace in force only over the past two months or so. Now that TI has made its major investment in capital equipment and is set up in Houston, it has firmed up an ambitious set of 1970 plans.

TI's invasion of the MOS market is not only a major commitment, but a broad, across-the-board onslaught. The firm now is scaling up three MOS processes for manufacturing: the standard process, 111-orientation crystal and thick oxide; 100-crystal orientation; and 111-orientation with silicon-nitride passivation for low-threshold voltage devices.

With low-threshold devices expected to take the dominant position in MOS, TI feels one approach will dominate. But it is too soon to determine which one at this point—nitride passivation, crystal orientation, silicon gate, or another.

**... and gives okay  
to silicon gate**

TI has changed its mind about silicon-gate MOS, and is now going full speed ahead. It expects to come out with its initial silicon-gate MOS circuit by the end of 1970.

When the first silicon-gate devices started appearing in mid-1969, TI would say only that it was monitoring the development and studying other techniques that appeared even more promising. This self-aligning gate technology, pioneered by Fairchild Semiconductor and Intel (both have products on the market now), not only offers lower threshold voltage, but reduces gate capacitance to a point where the speed of the MOS circuit can be doubled.

Another MOS technology that TI has decided to enter, again following the lead of other companies—RCA in this case—is complementary MOS. It's likely that the Texas firm will have its first C/MOS device in production by the end of the year.



---

# Electronics Newsletter

---

## Beam-leaded TTL due from Motorola

Many potential users of beam-leaded semiconductor devices have been unable to get them. Now it finally looks as though they'll be able to buy the devices from somebody besides Raytheon Semiconductor in the next quarter: Motorola will have series 5400 transistor-transistor-logic (MC 5400), available in both packaged and chip form, in quantity production then—several months later than promised. The TTL family could be followed by other logic types and possibly some linear circuits.

## Signetics makes LIC that needs no tuning

Signetics is ready to market a linear integrated circuit that requires no tuned circuit. One company spokesman believes the new circuit will become a universal building block—like the 709 op amp. The new monolithic device uses a phase-locked loop [*Electronics*, April 28, 1969, p. 94]. It's called a phase-locked signal conditioner and demodulator and has applications in communications and data equipment.

The circuit can perform frequency-shift keying, f-m demodulation, signal locking, reconstituting and conditioning, a-m synchronous detection, frequency multiplication and division, and signal searching and tracking. It operates throughout the frequency range from 1 hertz to 30 megahertz.

## Sperry realigns MIC thrust

Sperry Rand's Microwave Electronics division, which never really got rolling in microwave IC sales, now is working mainly on flight-line radar test equipment. Sperry intends to use its existing MIC facility and the almost completed semiconductor plant at Clearwater, Fla., originally slated to provide active devices for MIC component sales, for test systems.

The Clearwater plant will be used as a lab and for light production. Says a spokesman, "We'll make varactors, Schottky-barrier mixer diodes, avalanche and Gunn diodes—everything we'll need, except the transistors. All the products will find a place; R&D, for the sake of R&D alone, has no place at Sperry Microwave."

## Addenda

GE has introduced a data-communications processing system, Datanet-500, that's faster and has more capacity than the five-year-old Datanet-30. The 500's storage cycle time is 1.2  $\mu$ sec; the 30's is 7  $\mu$ sec. The new system offers three accumulators to one for the older unit; storage capacity and transfer rate are quadrupled, and there are twice as many input/output channels. . . . The FAA has decided to stick with Raytheon's planned-view-display equipment for the National Airspace System's enroute stage. Earlier, the agency had said it would switch to Sanders [*Electronics*, March 2, p. 78]. Raytheon will launch a parallel effort on a new design, to be delivered by December. Delivery of the first acceptable Raytheon display is two years late, and development cost has risen to \$62.9 million from \$44.8 million. . . . Despite the reports concerning General Instrument's pioneering semiconductor memory work to supply National Cash Register with 256-bit MOS random-access memories for upcoming versions of NCR's Century computer, GI says it still has an "open order" from NCR and that it shipped more of the MOS memories in February than ever before, but it wouldn't specify quantities. GI started having delivery problems last year [*Electronics*, Nov. 24, 1969, p. 33], and Signetics is said to be shipping modest quantities as a second source.





TRIG FUNCTION GENERATORS

Accuracy is the major design variable of trigonometric lookup tables built with MOS read-only memories. Only a few ROMs are needed for most practical applications, but accuracy can be made to increase very rapidly with memory capacity if interpolation techniques are used.

For instance, without interpolation a single 1024-bit ROM can store 128 angular increments and generate an 8-bit output that will be better than 99.9% of the handbook value (Table 1).

ADDRESS	DEGREES	BINARY OUTPUT	DECIMAL SINE
0	0	.00000000	0.000
1	0.7	.00000011	0.012
2	1.4	.00000110	0.023
3	2.1	.00001001	0.035
.	.	.	.
.	.	.	.
127	89.3	.11111111	0.996

TABLE 1. MM422BM/MM522BM Sine Function Generator

If one simply cascaded ROMs to improve input resolution and output accuracy for a high-accuracy trig solution ( $X=\sin \theta$ ) as in Figure 1, large numbers of ROMs might be needed. This 24-ROM system stores 2048 12-bit values of  $\sin x$  (or other trig functions), giving angular resolution of 1 part in  $2^{11}$  (0.05%) and output accuracy of 1 part in  $2^{12}$  (0.024%). The system in Figure 2 has the same resolution and is accurate to the limit of its 12 output bits (0.024%), which makes it just as good. But it only requires four 1024-bit ROMs and three 4-bit TTL full adders, so it only costs about one-fifth as much as the more obvious solution of Figure 1.

Instead of producing  $x = \sin \theta$ , the Figure 2 system divides the angle into two parts and implements the equation

$$x = \sin \theta = \sin (M + L) \\ = \sin M \cos L + \cos M \sin L$$

It can be programmed for any angular range. Assume the range is 0 to 90 degrees and let M be the 8 most significant bits of  $\theta$  and L be the 3 least significant bits of  $\theta$  ( $\theta$  being the 11-bit input angular increments, equal to  $90^\circ/2048$ , or 0.044 deg.) as in Table 2.

With an 8-bit address, the three 256x4 ROMs will give the 12-bit value of  $\sin M$  at increments of  $M = 90^\circ/2^8$ , or 0.352 deg. The  $\cos L$  can only vary between 1 and 0.99998. So we assume  $\cos L=1$  and store values of  $\sin M$  at 0.352 deg. resolution

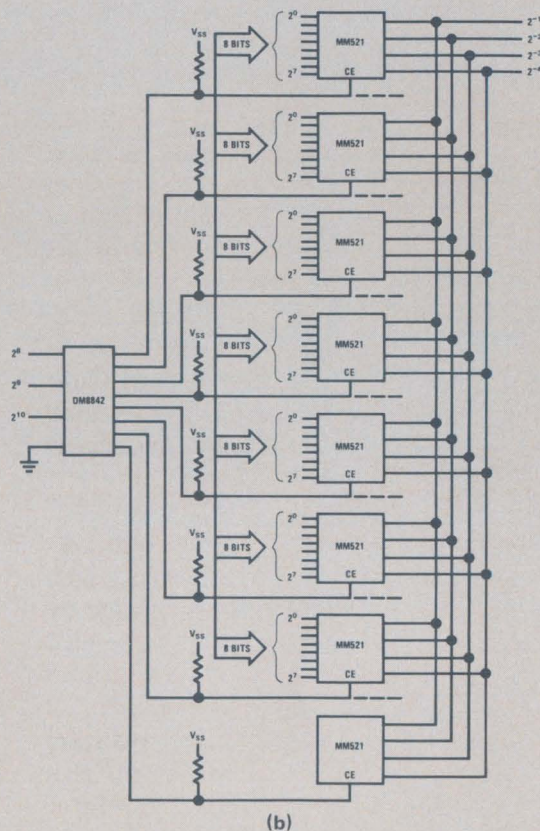
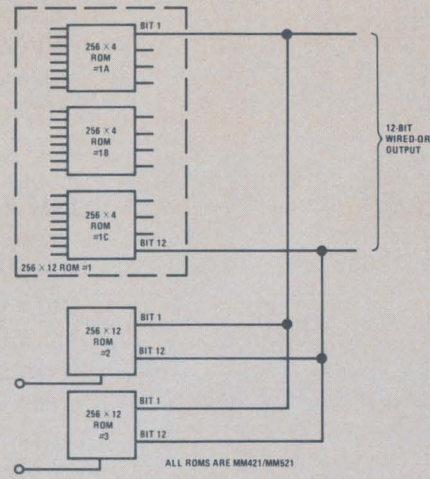

FIGURE 1. Conventional 2048-Increment Sine Table Uses 24 ROMs

in the top three ROMs, reducing the equation to  $\sin \theta = \sin M + \cos M \sin L$

Values of the second term are stored in the fourth ROM. The maximum value of the second term in the above equation can only be  $\cos M \sin L = 0.00539$  where  $\cos M_{max} = 1$ ,  $\sin L_{max} = 0.00539$ . This is the maximum value to be added to  $\sin M$  above. Only the five least significant bits



of a 12-bit output are needed to form the maximum output, so an MM522 is used in its 128x8 configuration.

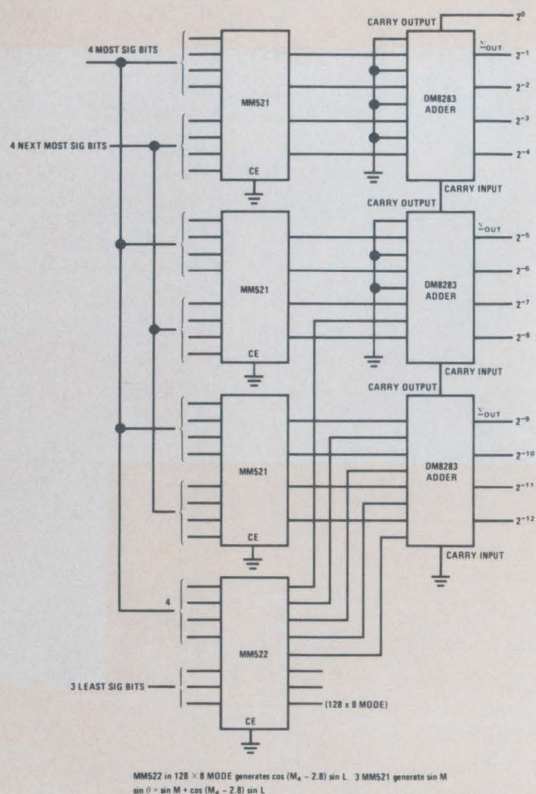

FIGURE 2. Four-ROM Look-up Table Generates 2048 Values of Sin x by Interpolation Technique.

Let the 4 most significant bits of M be called  $M_4$  and the angle at these increments be  $X_m = 90^\circ/2^4 = 5.63$  deg. Sin L (the 3 least significant bits of  $\theta$ ) has the same maximum as before and cos  $M_4$  has a maximum of cos 5.63 deg. = 0.99517, and continuing as follows:

$$\cos(11.26) = 0.98076$$

$$\cos(16.89) = 0.95686$$

$$\cos(84.37) = 0.09810$$

through the 16 increments of  $M_4$ . Now

$$\sin \theta = \sin M + \cos M_4 \sin L$$

and the appropriate cos M sin L values are stored in the fourth ROM. In effect, we have divided the  $0^\circ$  to  $90^\circ$  sine curve into 16 slope sectors with  $M_4$ , each sector into 16 subsections with M, and each subsection into 8 interpolation segments with L.

Since we are using an approximation, accuracy is not quite as good as the Figure 1 system. The additional error term is cos L, assumed 1 but actually is a variable between 1 and 0.99998. At every eighth increment, L is zero, making cos M

ADDRESS	M			L
	M <sub>4</sub>			
0				0
1				1
2				1 0
3				1 1
4				1 0 0
5				1 0 1
6				1 1 0
7				1 1 1
8				1 0 0 0
9				1 0 0 1
16			1 0	0 0 0 0
32			1 0 0	0 0 0 0
64			1 0 0 0	0 0 0 0
128		1	0 0 0 0	0 0 0 0
256		1 0	0 0 0 0	0 0 0 0
512		1 0 0	0 0 0 0	0 0 0 0
1024	1	0 0 0	0 0 0 0	0 0 0 0
2048-1	1 1 1 1	1 1 1 1	1 1 1 1	1 1 1 1

TABLE 2. Programming of 2048-Increment Sine Table

sin L=0, and sin x=sin M to 12-bit accuracy. Then the error rises to a limit of near 0.002% at every eighth increment where L is 0.352–0.044. This error can be halved by adjusting the fourth ROM's output so that

$$\sin \theta = \sin M + \cos(M - 2.81^\circ) \sin L$$

If five ROMs are used—four MM521's and all eight outputs of the MM522—15-bit accuracy can be achieved, and thus improving the accuracy by a factor of eight. The resolution could also be smaller as in an application involving a sensor with a limited field of view. Variations of the system could be used to space the increments irregularly to compensate for sensor nonlinearities, to improve accuracy in specific angular ranges.

This example has a binary fraction output, like the sine function generator in Table 1. For instance, the 8-bit output at the 64th increment representing sin x = sin 45° is 10110101. This equals  $1 \times 2^{-1} + 0 \times 2^{-2} + 1 \times 2^{-3} + 1 \times 2^{-4} + 0 \times 2^{-5} + 1 \times 2^{-6} + 0 \times 2^{-7} + 1 \times 2^{-8}$ , which reduces to 181/256 or 0.7070. Handbooks give the four-place sine of 45° as 0.7071, so at this increment the output is accurate to approximately 0.01%. This table, the MM422BM/MM522BM, is used in fast Fourier transform, radar, and other signal-processing applications.

Other standard tables that are available off the shelf include an arctan generator, several code generators (EBCDIC to ASCII, BCD to Selectric, and Selectric to BCD) and ASCII-addressed character generators for electronic, electrical and electromechanical display and printout systems. All interface with TTL logic and operate off 12-volt power supplies. Write for data sheets, or use one of our programming tables to jot down any special input-output logic functions you need.

**National Semiconductor Corporation**

2900 Semiconductor Drive, Santa Clara, California 95051  
(408) 732-5000 / TWX (910) 339-9240





# TEST MSI/LSI ARRAYS with . . . . .

## Rapid Protracted Volubility

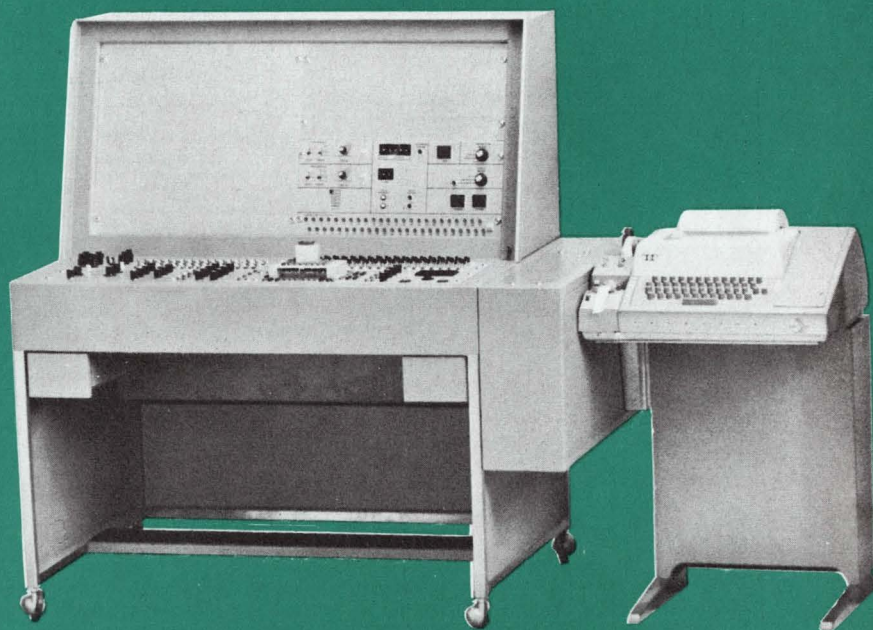

Who ever heard of rapid protracted volubility (RPV)? We suspect that up till now, no-one has—and no-one but NAES has it. But who needs it? If you manufacture or use MSI/LSI arrays, you need it—if not immediately, surely soon.

RPV aptly describes our new TC 4800 LSI test system which has rapid (1.5 MHz) protracted (4096 bits) volubility (48 words). That's plenty of speed, length and depth to exercise large read-only memories and the most complex of logic functions. By comparison, the others are easy.

TC 4800's heart is a core memory (196,608 bits) which repeats the program with unflinching accuracy. TC 4800's other functional units have been reliability-proven by over two years use at America's largest manufacturers and users of arrays in our TC 4100 and TC 9200 systems.

Check the abbreviated specs below. Call (or write) Jack Straub for further details.

### ABBREVIATED SPECIFICATIONS

- Number of Outputs (Words) — 48
- Depth of Pattern (Bits) — 4096  
(But adjustable from 10 to 4096 in single bit increments)
- Bit repetition rate — DC to 1.5 MHz
- Software or Hardware programmable by cards, teletype or paper tape
- Software or Hardware correctable
- "Lead Phase Select" with adjustable ratio
- TTL output levels

*Meet us at the IEEE Show—location 2G43, 2G45.*

For complete information, write or phone:



**North American Electronic Systems**

Sicklerville, N.J. 08081 Tel. 609-629-4141

A Division of Educational Computer Corporation

An EDP Technology Company

← Circle 36 on reader service card

Circle 37 on reader service card



# Litton specializes in surface waves.



## We are delivering surface wave delay lines.

Litton is out of the research phase and is delivering devices. We're ready to accept large quantity orders, now.

Our delay lines, as represented by the two configurations shown here, are typically  $\frac{1}{4}$ -inch in cubage. They feature insertion loss as low as 8db, 120 nanosecond to 10 microsecond delay and up to 500 milliwatt CW power handling capability. Delay lines are available in the frequency range of 60-1100 MHz. Present instantaneous bandwidth is typically 20 per cent at the higher end of the range. Our devices can be tailored to your individual requirements, and

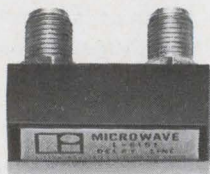

engineering service is available to match Litton delay lines to your system.

If your applications are in areas such as fuzes, transponders, or high accuracy DME; or if your problem can be solved using analog techniques such as high resolution frequency discrimination or time domain correlation, now you can look to the leader, Litton, to deliver. Contact Electron Tube Division, 960 Industrial Road, San Carlos, California 94070. (415) 591-8411.

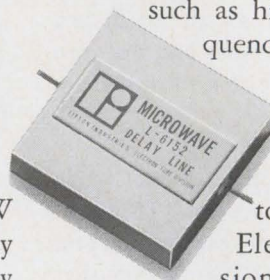

 **LITTON INDUSTRIES**  
**ELECTRON TUBE DIVISION**



# Test drive the new Honeywell 2206 Visicorder

That's right. Go ahead and test drive it . . . mounted, for example, in an automobile. Or a tractor. Or on a piece of heavy machinery. Or even in a pleasure boat. This is the oscillograph that's built so rugged and so light-tight (with integral take-up), it goes where other recorders fear to tread. And that consumes only 150 watts . . . from a standard vehicle electrical system or from separate batteries . . . for complete portability.

What's more, when you choose our new 2206 Visicorder, you don't sacrifice performance for portability. In fact, this oscillograph does everything you'd expect a Honeywell Visicorder to do, recording up to 12 channels of data simultaneously, plus two event channels, at frequencies ranging from 0 to 13kHz.

Because this Visicorder uses a mercury lamp with true ultraviolet recording, it also gives you some other interesting bonuses, like high writing speeds (over 40,000 in/sec.). Plus

more stable records. Plus better trace density. And even offers you, as an option, an amplifier package that groups all signal conditioning into a single unit, and that fastens right to the Visicorder itself.

To arrange a test drive of our new Honeywell 2206 Visicorder or to just get more information, call your nearest regional sales manager (listed below), or write: Honeywell Test Instruments Division, P.O. Box 5227, Denver, Colo. 80217.

**Regional sales offices:** Albuquerque, NM (505) 345-1656, Dave Dimick; Chicago, IL (312) 674-9770, Frank Doherty; Long Island City, NY (212) 392-4300, John Paull; Los Angeles, CA (213) 724-3500, Durke Johnson; McLean, VA (703) 893-4660, Milt Womack.

## Honeywell

Honeywell engineers sell solutions

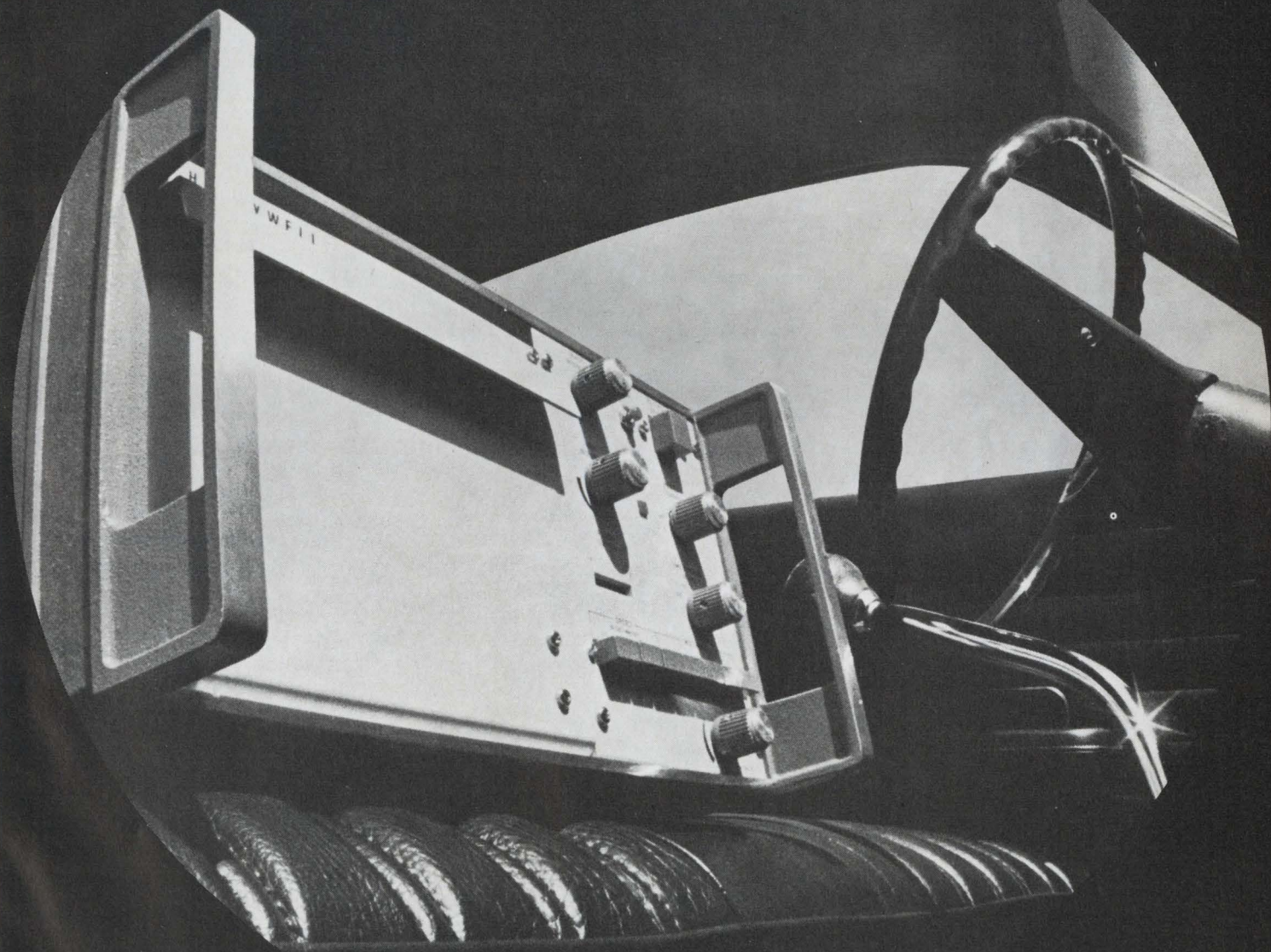



# A quick guide to magnetic drives: torque transmitters that work when other methods won't.

Magnetic drives offer you some relatively inexpensive solutions to difficult torque transmission problems. For instance, a magnetic drive can transmit torque through a non-magnetic barrier without using any mechanical connection. And because the system completely eliminates seals, it eliminates problems of leakage, maintenance and contamination.

## 3 basic types of magnetic drives.

1) *Synchronous drives* are equivalent to a shaft connection. Two basic arrangements are axial and radial. Axial drives consist of two Indox magnets or two Alnico side pole rotor magnets. Axial thrust is a maximum at zero load and diminishes as more torque is applied.

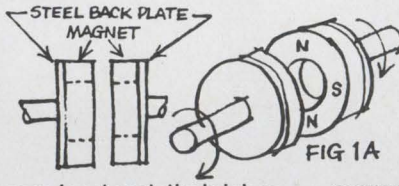

FIG 1A

Radial drives consist of two ring magnets and have no axial thrust. Because of starting in-

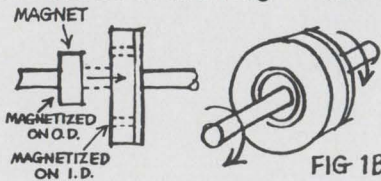

FIG 1B

ertia, the outer magnet normally drives the inner one. When the maximum torque of a synchronous drive is exceeded, the driven member stops. This can offer important protection in event of overloading. And you never have to replace shear pins or worn frictional surfaces.

2) *Eddy current drives* use the field of a rotating permanent magnet to induce eddy currents in a conducting material.

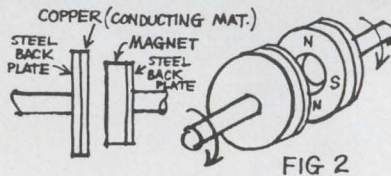

FIG 2

Interaction between these currents and the magnetic field gives rise to the torque of the coupling. Torque varies with the relative speed of the members. Eddy current drives use driven members of aluminum or copper in the form of cups, tubes or discs depending upon the configuration needed.

3) *Hysteresis drives* use the magnetic field of a rotating permanent magnet to drive the material of the hysteresis member through its hysteresis loop. The unit is syn-

chronous provided the maximum torque isn't exceeded. Beyond this point the torque is independent of the slip speed and remains constant.

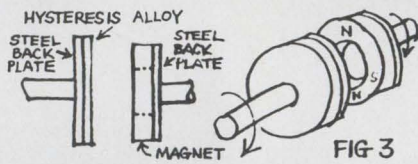

FIG 3

Hysteresis drives operate at close gaps. But unlike eddy current drives, hysteresis drives transmit constant torque.

## Design aids available free.

The basic factors to consider in magnetic drive design include:

- radial or axial gap configuration
- relationship of torque to slip speed
- ambient operating temperature
- non-magnetic material through which torque must be transmitted
- maximum torque to be transmitted
- critical nature of the alignment.

We're anxious to help answer your questions. And we would like to send you some useful aids that include graphic presentations of important factors in magnetic drive design. Just write Indiana General, Magnet Products, Valparaiso, Ind. 46383.



a division of Electronic Memories & Magnetics Corporation



# TRW Semiconductors *controls motion*

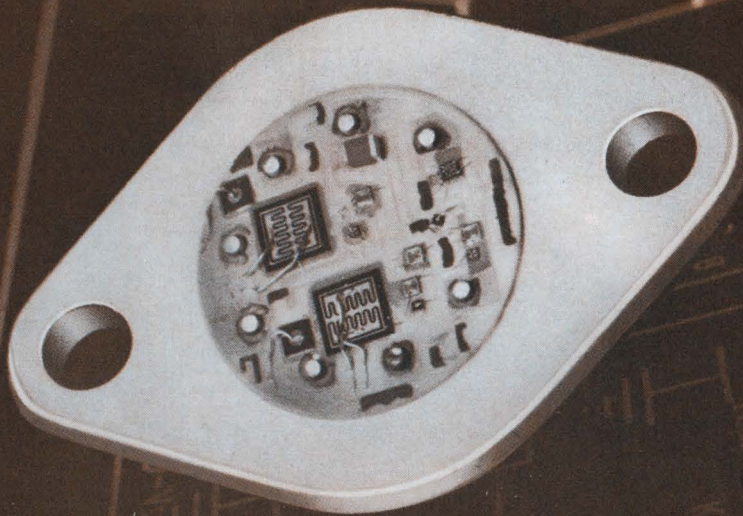

## 200 Watts Output...90% Efficiency...0.1% Linearity

TRW announces a hybrid switching mode amplifier that delivers 200 watts output power from an 8-pin TO-3 package. It represents an 8:1 size reduction over equivalent discrete component class B amplifiers.

Intended primarily for use in motor drive applications, these amplifiers provide a highly linear

current drive control system even when operated from an unregulated power supply. They utilize high speed switching techniques (10 amps output current in 500 ns) to implement the pulse width modulation operation.

For further information, including theory of operation and appli-

cations assistance, contact TRW Semiconductors Division, 14520 Aviation Blvd., Lawndale, Calif. 90260. Phone: (213) 679-4561. TWX: 910-325-6206.

# TRW<sup>®</sup>





## This is any digital logic system you can think of.

Gentlemen: I have a design for a digital logic system and I understand you have everything I need to put it together. Please send me complete information on the compatible system elements I checked below:

- J Series logic modules.** A high quality line at moderate prices, using commercially available DTL and TTL circuits with noise-immune packaging.
- T Series logic modules.** Proprietary IC's designed into noise-immune circuits. Highest fan-in and fan-out available.
- Automated wiring services.** Computer generated list-

ing; error-free verified wire-wrapping. Complete documentation provided.

- Mini-computer.** A 16-bit processor with powerful instructions that conserve memory and an I/O structure with four different operating modes.
- Analog instruments.** Low-level and high-level multiplexers, digitizers, D-to-A converters. 10, 12, or 15-bit resolution, choice of high or medium speeds, free-standing or coupled to the mini-computer.
- All of above.**

NAME \_\_\_\_\_ TITLE \_\_\_\_\_  
 COMPANY \_\_\_\_\_ PHONE \_\_\_\_\_  
 ADDRESS \_\_\_\_\_ CITY \_\_\_\_\_ STATE & ZIP \_\_\_\_\_

Send to: Xerox Data Systems, Dept. A, 701 South Aviation Blvd., El Segundo, Calif. 90245  
 If you can't wait, call (213) 679-4511 ext. 3668 or 3391

**XDS**  
 Xerox Data Systems  
 El Segundo, California



# How to kill energy-sapping parasites

Bell Labs combines low-power transistors into high-gain microwave structure that eliminates emitter inductance losses and triples gain-bandwidth

Even though circuits presented in the microwave sessions of the International Solid State Circuits Conference in Philadelphia were complex and often unique, one thing seems clear: microwave solid state technology still has a way to go before reproducible, high-performance, low-cost devices and circuits can be routinely produced. This is not a new story; long plagued by unreliable microwave materials, worn-out circuit designs that often couldn't cope with high microwave losses, and lack of understanding of semiconductor physics at high frequencies, microwave workers seem unable to move off the development plateau.

Many feel that what's needed is a period of retrenchment in order to use well what's already been developed in the lab. Unglamorous as it may sound, the prevailing feeling outside the conference doors was that proper packaging—efficiently getting microwave components into a real-world, high-performing configuration—may be the vital missing link to practical solid state microwave devices.

One of the most exciting developments reported at the conference that helps to provide this link is a new microwave power-transistor structure developed by R.V. Goordman and his associates at Bell Labs. Called Eidap (emitter-isolated difference-amplifier paralleling) by its inventors, the new structure is a broadband high-power uhf and microwave device. Its high power is from uniquely paralleled pairs of transistor chips; as a result, it could have great significance in many communications systems. In fact, one immediate application could be in Bell's microwave repeater links which cur-

rently use vacuum traveling-wave tubes and triodes. Other applications include driving the deflecting plates and coils of high-speed cathode-ray tubes, and in balanced-transmission lines and high-speed

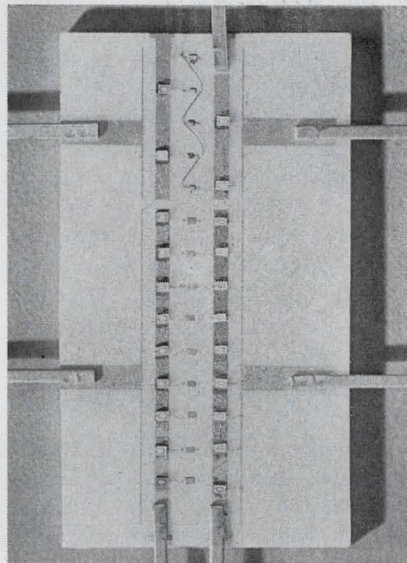

**Big gain.** Bell Labs' Eidap is broadband two-stage amplifier yielding insertion gain of 33 db over 500-Mhz bandwidth. It has nine p-n-p/n-p-n transistor pairs.

memories. Pulse-code modulation systems using multilevel coding are also strong application candidates.

**Parallel.** Basically, the Eidap structure parallels its transistors to obtain its high power but at the same time attacks the lead inductance in the transistor emitter, so limiting in other parallel-transistor configurations at high frequencies. Stated simply, to get gain you have to have transadmittance. And since transadmittance is important to gain, it is clearly desirable to have

a flat or constant transadmittance with frequency—the larger the better.

But the emitter-lead inductance places a frequency-dependent series impedance in the emitter path which reduces the magnitude of the transadmittance, making it fall off faster with increasing frequency. This kills the gain.

The problem is solved with Bell's Eidap structure. Using a different amplifier design as one feature of its construction, it gets rid of the ground-plane inductance; in fact, the node where the emitters are joined constitutes a virtual ground of zero inductance. Equally important, the paralleling arrangement significantly minimizes the emitter-to-emitter inductance which is so troublesome at high frequencies.

In this model, nine-pair transistor chips have been paralleled so that the emitter inductance is reduced by a factor of nine; if  $n$  parallel chips are used, an  $n$  reduction would be achieved, an important implication for higher-order paralleling.

The inductance reduction occurs essentially because now the emitter wires are mutually isolated—although they are still virtually in parallel—so that mutual inductance between them is reduced. In addition, a greater number of smaller chips permits smaller emitter-to-emitter spacing, further reducing the effective inductance. And the thermal heat transfer is improved by the chip's being physically separated by a distance of at least one chip diameter.

On the other hand, if complementary circuitry is required, the chips can be physically located a negligible distance from each other. Using many small chips instead of



two large ones eliminates the local defects and hot spots that are common to large-area chips.

Both a one-stage and a two-stage Eidap amplifier have been constructed using nine p-n-p and nine n-p-n chips. These devices, operating at 500 megahertz, show an insertion gain (between 50-ohm terminations) of 15 decibels for one stage and 33 db for two stages, and unsaturated peak power into a 112-ohm load of 11 watts. More important, the gain-bandwidth product is 2,500 Mhz with a bandwidth of d-c to 500 Mhz for a voltage gain of about 5—a bandwidth of many octaves compared to 5% to 10% for conventional parallel-transistor amplifiers.

### Microwave

#### Transistors live

Developments in solid state microwave have been scarce. Getting up above a couple of gigahertz at usable power levels is no picnic, due largely to the menace of inefficient sources, high lead losses, and low-power gains.

Enter the transistor. There was a time not long ago when this little device was considered to be practically worthless at frequencies above 5 Ghz, and nothing to write home about at 1 Ghz. Yet the transistor, which ushered in modern electronics, may yet become the dominant component in microwave devices. This is certainly true for bipolar transistors; it may well hold for field-effect versions as well, especially in low-noise amplifiers.

Fairchild Semiconductor has developed a new gallium-arsenide FET that has a maximum frequency of oscillation of greater than 12 Ghz. GaAs was chosen over silicon because of its higher mobility, and although it requires more stringent fabricating techniques at present, improvements in the handling of material should ease this problem.

**Refined.** Fairchild's FET employs an epitaxial n-type channel deposited on a semi-insulating GaAs substrate with a Schottky-barrier gate, which is nothing special. But

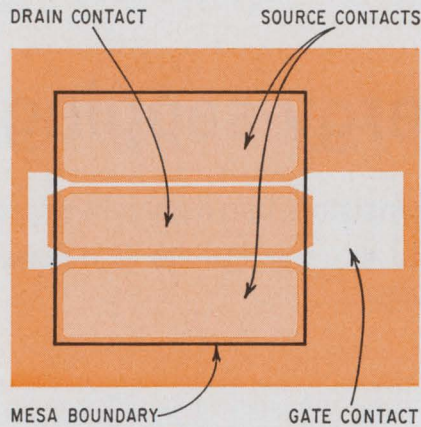

**Competitive.** Fairchild's new gallium-arsenide FET has a maximum frequency of oscillation over 12 Ghz.

the company, in a project directed by George Bechtel, has managed to refine the contact technology and device geometry so that significant improvement in FET performance has been achieved. And equally important, since device fabrication is relatively simple compared to bipolar transistor technology—no critical diffusion step is needed—high-volume, low-cost production may be in the offing. That's a particularly attractive possibility when you consider the present production grief of microwave devices.

The key to the high-frequency operation has been the ability of Fairchild to keep the extrinsic source resistance small at operating frequency by using low-resistance source-drain contact material and by placing contacts as close as possible to the gate. What's more, parasitic output conductance is avoided by fabricating the FET's on high-resistivity substrates— $10^7$  ohms-centimeter.

Fairchild FET's have been routinely made with gate-to-source and gate-to-drain spacing of .2 microns and 4 microns respectively, with a film thickness of approximately 0.5 micron. Over a 1 Ghz to 6 Ghz range they show gains of approximately 20 decibels to 5 db, with the expected decrease of 6 db per octave, extrapolating to unity at 13 Ghz ( $f_{max}$ ). Further, these FET's gave minimum noise figures of 3.5 db at 2 Ghz, making them excellent contenders to low-noise amplifiers.

### A new phase

When phased-array designs for radar antennas began appearing in the literature many people thought they'd quickly replace the conventional mechanically-steerable systems. Clearly it hasn't turned out that way. The number of components necessary in the array and the high-power continuous-wave requirements have limited phased arrays largely to discussions at technical meetings and breadboard designs in laboratories.

But interest persists, due primarily to the attractiveness of phased array's electrically steerable properties and adaptability to planar fabrication. E.F. Belahoubeq and his team at RCA's Princeton labs, working under an Air Force contract, have developed an S-band c-w power module especially designed for phased-array radar. It delivers 15 watts of source power in the 3-gigahertz range, well within the requirements of today's systems.

**Small and tight.** Using commercially available transistors (RCA TA7205) as its building block, the amplifier module has an unusual strip-transmission-line transistor carrier that permits the use of several transistors in parallel in a minimum space—80 by 190 mils—and does it without the instability and high losses usually encountered when paralleling transistors at those frequencies. Further, the carrier includes an internal impedance transformation that raises the very low and complex input impedance of the transistor to a purely resistive value of approximately 20 ohms, an important design feature for low-loss transistor matching. What's more, this carrier design provides excellent isolation between input and output. Moreover, because the bonding wires are connected directly to the transmission lines, the carrier does away with the conventional bonding pads.

The module consists of three sections—a preamp driver, which requires an input of 100 milliwatts at a frequency of 1.5 Ghz, a divider-amplifier stage which delivers a minimum of 15 watts, and a final doubler-combiner stage which up-



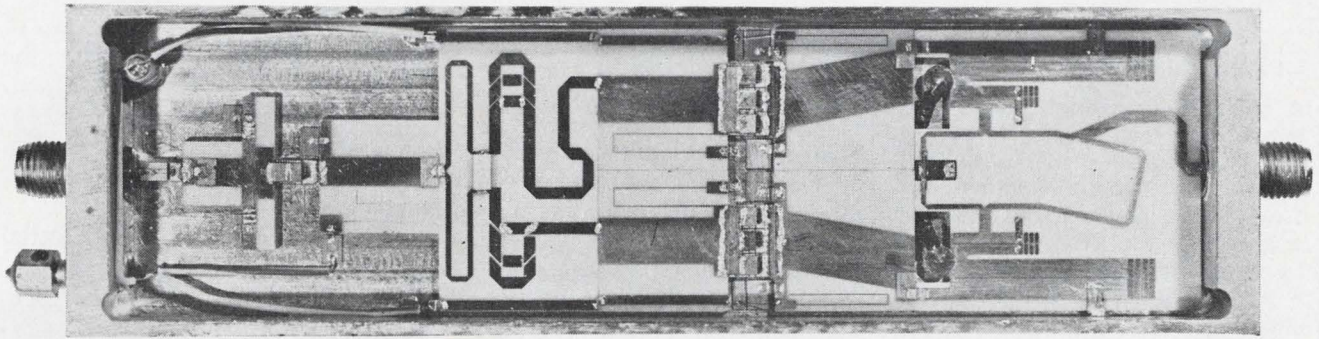

**Integration now.** Using both planar and hybrid IC fabrication, RCA's S-band power module is 1.2 inches wide, 6 inches long, and 0.75 inch high. It consists of a preamp-driver combination, a power splitter and phase adjuster, a pair of triple transistor amplifiers, a hybrid combiner, and a doubler. A 1.5-Ghz, 100-mw signal input results in 3-Ghz, 15-w output.

converts the signal into the 3-Ghz range. The key to the amplifier is a triple-chip-transistor pair that's put in parallel to get the big c-w power—actually 17.5 to 21.5 watts at 1.4 to 1.6 Ghz. The package has an inside width of only 1.2 inches, considerably smaller than conventional coaxial packages. Furthermore, the design allows easy connections to microstrip transmission lines, offering the possibility of circuit integration.

The amplifier stages are matched by an optimizing technique that consists of taking power-load contour measurements. The technique involves taking the input impedance of the individual stages as a function of driving frequency and, with this data, designing the proper interstage matching network.

Overall performance of the module makes it ideally suited to phased array applications. Peak efficiency is 53% with a 1-decibel bandwidth of 13%. Moreover, peak efficiencies up to 58% have been obtained with lower drive levels and 1-db bandwidths of 20%.

## Communications

### 'Can you hear me?'

The police aren't particularly happy about the personal transceivers currently offered by industry. They say the radios—the kind patrolmen carry—are not designed with law enforcement in mind; rather, they're developed for a broad range

of users. Industry sources reply that they not only must deal with a highly fragmented police market that has widely differing ideas on what is needed, but must trade off specifications to come up with a product that will have broad market appeal beyond law enforcement.

Because of these problems and because officials at the Law Enforcement Assistance Administration feel there are too few companies involved in developing and marketing hardware for law enforcement use [see p. 4], LEAA's research arm, the National Institute of Law Enforcement and Criminal Justice, is going to try to do something about it.

**Help asked.** Due this month is a unique request for quotes, and if this procurement works, it could be the ground-breaker for other types of procurement for hardware aimed at the law-enforcement market.

The basic intent of the request is to design, develop, and produce a family of new personal transceivers. LEAA, which administers the Omnibus Crime Control and Safe Streets Act of 1968 in the Justice Department, even will pay for hard tooling to produce the transceiver.

Walter Key, program manager for electronics and communications at the institute, wrote the design specifications. With a basic understanding of police needs, he's taken their requirements and translated them into something "that an electrical engineer can respond to."

More than one development contract may be awarded to provide

the competitive selling environment required by city purchasing agents, Key says. Phase one—development and testing of prototype units—will be due a year after the date of award. Phase two—production design and initial production—is scheduled for six months later. This kind of timing, Key notes, will require an intensive effort by contractors.

LEAA hopes that the way the rfq is written and released will increase the number of bidders. The procurements will be written "in true militarese" according to Key. Normal Armed Services Procurement Regulations (ASPR) will apply. Moreover, the rfq will be released by the Air Force's Aeronautical Systems Division, Wright-Patterson AFB, Ohio. This is partly because the LEAA institute doesn't have its own procurement agency.

**By the numbers.** LEAA is taking this tack because "we want to get companies that have the capacity to bid." Large numbers of military companies have such a capacity, he says, but they're not actively in this area now. "So we felt we had to deal with them in ways they're accustomed to," he notes.

Key is convinced that they can come up with a portable transceiver tailored specifically to law-enforcement needs. High priorities in his design are light weight, small size, tailoring to the requirements of law enforcement users (particularly through human-factors engineering), minimum cost (both initial and operational), high reliability, and maintainability.

Performance requirements are tight because of the life-and-death



## Clothes quarters

A major—and neglected—area in designing personal police transceivers is human factors. Walter Key of the National Institute of Law Enforcement and Criminal Justice says the primary need is to design the radio around police requirements, which also plays an important role in achieving performance requirements. For example, it is easier to obtain good frequency stability if the designer knows that the radio would be worn next to the body of the user and thus avoid the full variations of ambient conditions. The designer wouldn't have to worry about the radio operating in the temperature range of a closed automobile—measured at  $-22^{\circ}\text{F}$  to  $+185^{\circ}\text{F}$ .

situations that patrolmen encounter; as a result, police will pay more. For example, the police are paying around \$1,000 for a typically-equipped portable. In contrast, the military's personal transceiver, the PRC-25, is going in quantity now for around \$900. Some of the specifications are beyond the military's, according to Key—frequency stability, for example.

Police officers often are required to use their portable radios when apprehending or detaining a suspect, so ease of operation and resistance to deliberate damage is necessary. Key wants industry to minimize the physical manipulations needed to use the radio. Also, manufacturers will have to assume the radio will be worn in such configurations as an under-the-arm shoulder holster and epaulet speaker-microphone-antenna units.

**Keep it working.** Maintainability and reliability for the family of radios will be critical. Most police agree that equipment that cannot be maintained at field level—by locally available radio technicians—is no good. So specs will emphasize high-reliability packaging techniques without the need for factory-level repair. It wants integrated circuits and hybrid modules used wherever possible. But Key warns that companies can't just deliver these units and forget about them.

## Advanced technology

### Cause for effect

A bit more evidence that Stanford R. Ovshinsky's amorphous semiconductors really work has turned up: several research labs have given them what amounts to an almost clean bill of health. Some confirmation of Ovshinsky's claims had been offered about a year ago [*Electronics*, March 3, 1969, p. 58].

What may be the most prestigious comment comes from MIT, where associate professor David Adler and assistant professors D.J. Sellmyer and S.D. Senturia of the Center for Materials Science and Engineering put a tellurium glass through its paces. Adler says that the MIT group not only used glass supplied by Ovshinsky, but also made its own—whose performance differed only slightly from Ovshinsky's.

**Arsenic factor.** "We received a five-inch chunk of the glass," says Adler; it operated as a so-called memory switch, and its composition was about 81% tellurium, 15% germanium, and 4% arsenic. A controlling factor in whether a tellurium glass acts as a memory device or a switch appears to be the ratio of tellurium to arsenic used, he says. "Larger percentages—say 30% arsenic—would produce a threshold device," he adds. Graduate students are working on such devices now, and may have data on them by midyear.

In the MIT experiments, the memory switch performed as advertised with a pulse sending it into the conductive state, and it stayed conductive after the voltage was withdrawn. Also, it was possible to turn it back into an insulator later with a short current pulse. Adler says that the pulse parameters aren't critical—if the device doesn't work, a little more voltage or current can be applied. This brings up what may be one of the more important, if less flattering, details unearthed about the amorphous devices—their characteristics change with operation.

**Changes.** Work at other labs seems to indicate that repeated operation of a switch—say as an os-

cillator—increases the amount of voltage needed to trigger the change from the conductive to non-conductive state. Too much current in a single applied pulse also can change the device's threshold voltage.

This data may give a clue to the device's method of operation; perhaps the effect is thermal. Electricity pulsed through an amorphous semiconductor may cause momentary filaments of conductive liquid or perhaps some form of near solid state plasma. If this were the case, the germanium dopant would tend to migrate away from these filaments, which in turn would increase the voltage needed to switch the semiconductor.

Iowa State University is said to have noticed this phenomenon while examining the Ovshinsky switch. It is reported that the material used at Iowa State was almost 40% arsenic and 60% tellurium, with only a minor amount of germanium used to prevent crystallization of the mix into  $\text{As}_2\text{Te}$ . And the change in threshold voltage may have been due to crystallization in what had been conductive filament paths.

More damaging were findings of the Xerox Corp., which noticed electrode material migrating into the thin-film semiconductor, causing crystallization. Xerox is said to have used both gold and moly electrodes.

**But . . .** But if your application can live with changing parameters, Ovshinsky's devices may be its sip of tea. An Army electronics laboratory is said to have constructed an amplifier for use in a high-radiation environment. Although it had a gain of only 2.5 the amplifier was able to stand neutron levels that nothing else could—"Ovshinsky devices are so hard," says an authority, "that the test cables fall apart from radiation before the semiconductors stop operating."

So, even though the triggering voltages changed with time, a feedback network was built into the amplifier to compensate, and the tradeoff still was a favorable one. According to one source, the Ovshinsky devices should hold out against nearly any radiation dam-







Go ahead . . .  
**72 Unitrode salesmen are waiting to quote you savings from 63¢ to \$12 each on thousands of *power transistors* . . . ready to ship right now!**

- Comparable savings on all part numbers
- Shipped from distributor stock
- Your order processed in 24 hours
- All orders shipped fastest way
- Every part Unitrode quality

**ALL THE MOST WANTED PACKAGES IN MEDIUM FREQUENCY RATINGS**

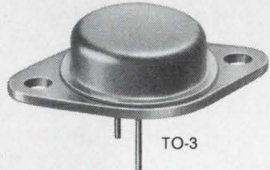
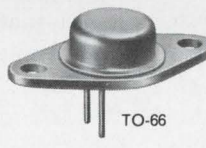
	5-100 mHz	0.5-30A	80-300V	
TO-5		TO-3		TO-59
	PLUS TO-61 TO-63 TO-111 (TO-59 isolated case)			
2N1714-17 2N2150-51 2N2657-58 2N2811-14	2N2877-80 2N3418-21 2N3744-52	2N3878-79 2N3996-97 2N3996-99	2N4000-01 2N4075-76 2N4150	2N4300 2N4301 2N4863 2N5038-39

SSPI PRODUCT GROUP

**GO AHEAD... MAKE THE CALL RIGHT NOW!**

**ALBANY**  
 Compar Albany  
 (518) 489-7408

**ALBUQUERQUE**  
 Compar Rocky Mtn.  
 (505) 265-1020

**BALTIMORE**  
 Daniel & Co.  
 (301) 825-3330

**BINGHAMPTON**  
 Compar Albany  
 (602) 723-8743

**BOSTON**  
 Compar N.E.  
 (617) 969-7140

**BOSTON**  
 Kitchen & Kutchin  
 (617) 862-8230

**CHICAGO**  
 Carlson Electronics  
 (312) 774-0277

**CLEVELAND**  
 Gibson Electronics  
 (216) 731-8330

**DALLAS**  
 Compar Southwest  
 (214) 363-1526

**DAYTON**  
 Gibson Electronics  
 (513) 434-7860

**DENVER**  
 Simpson Associates  
 (303) 798-8439

**HOUSTON**  
 Compar Southwest  
 (713) 667-3420

**LOS ANGELES**  
 Compar Los Ang.  
 (213) 843-1772

**MELBOURNE**  
 Conley & Assoc.  
 (305) 262-2054

**MINNEAPOLIS**  
 Compar Twin Cities  
 (612) 922-7011

**MINNEAPOLIS**  
 Stan Clothier Co.  
 (612) 869-3231

**MONTREAL**  
 Kaytronics Eng.  
 (514) 487-3434

**NEW HAVEN**  
 Compar N.E.  
 (203) 288-9276

**NEW HAVEN**  
 Kitchen & Kutchin  
 (203) 239-0212

**NEW YORK CITY**  
 Compar New York  
 (201) 473-2660

**NEW YORK CITY**  
 Milgray Electronics  
 (212) 989-1600

**ORLANDO**  
 Conley & Assoc.  
 (305) 365-3283

**PHILADELPHIA**  
 Daniel & Co.  
 (215) 887-0550

**PHOENIX**  
 Compar Rocky Mtn.  
 (602) 947-4336

**POMPANO BEACH**  
 Conley & Assoc.  
 (305) 943-8284

**ROCHESTER**  
 Compar Albany  
 (716) 271-2230

**SALT LAKE CITY**  
 Compar Rocky Mtn.  
 (801) 364-1163

**SAN FRANCISCO**  
 Compar S.F.  
 (415) 347-5411

**SEATTLE**  
 Compar Northwest  
 (206) 822-4191

**ST. LOUIS**  
 Carlson Electronics  
 (314) 991-0262

**SYRACUSE**  
 Compar Albany  
 (315) 471-3356

**TAMPA**  
 Conley & Assoc.  
 (813) 822-0161

**TORONTO**  
 Kaytronics Eng.  
 (416) 638-5511

**UNITRODE**



580 Pleasant St., Watertown, Massachusetts 02172 • (617) 926-0404



## U.S. Reports

age except transmutation of their component elements—something no other common semiconductor can claim.

### Manufacturing

#### Adding a dimension

Manufacturers of microcircuits, both hybrid and monolithic, want to know how deep their etch processes are cutting, and—for the hybrid maker—the thickness of deposited resistors and conductors. To date, the electromechanical profiling equipment available to them has been limited to two-dimensional, one-line profiles that show the height of hills and valleys at one point across the circuit.

Process control engineers want to know more. Engineers at the Gaging and Control division of Gould Inc., El Monte, Calif., say customers for their surface analyzers often want to know what the topography looks like at points on either side of the line. So Gould has come up with an instrument that will scan the entire surface of a specimen, giving a hard-copy "three-dimensional" picture in which the z axis is greatly exaggerated to show deposition thicknesses and surface defects in sharp contrast.

**Market? You bet.** Gardner Wilson, division manager, says he knows of no other electromechanical machine like Gould's Micro-Topographer, and frankly admits he's not sure just how widely the machine will be used. But he's certain there's a viable market for the new machine.

Potential customers, including some who use the division's single-line-producing surface analyzers, have asked Gould to look at memory disks, and the recording heads used with them, to determine how flat the disk surface is or to pinpoint the microgeometry of the recording head.

If the flatness of a recording disk varies too much, the head may not pick up a signal as it passes across a problem area, and data losses occur. Or if unusual deposits exist

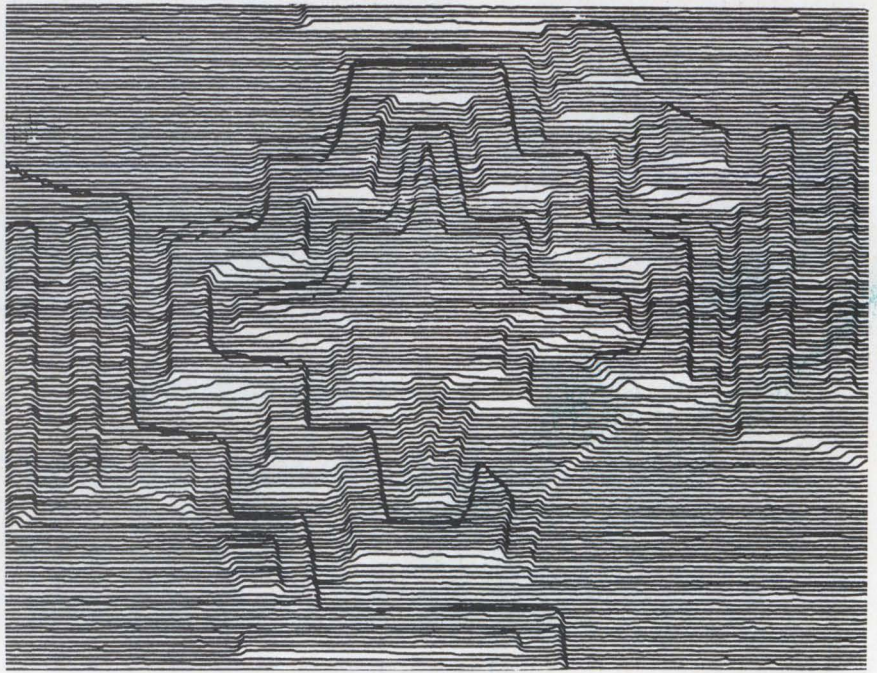

**On a clear day.** This image from Gould Micro-Topographer, before it was photographically reduced, was magnified 200 times in x and y axis and 2,000 times in the z axis. The actual height differences between troughs and ridges is about 30 microinches.

on the recording head, such as epoxy buildups, the head could scratch the disk. The Gould division has been able to detect such deposits ranging in thickness from 10 to 80 microinches with the Micro-Topographer.

**Flat world.** The machine works as follows. A sharp diamond stylus with a tip radius of 0.1 mil rides across the specimen using a reference table that is extremely flat—to within "a couple of microinches over a 2-inch-by-2-inch area," says K.E. Sihvonen, senior project engineer. The stylus moves in the x axis, with the reference table determining any deviation from the reference level. That level is printed out on the x-y recorder associated with the machine as movement in the vertical direction, or z axis. Thus, as the stylus scans across the flat areas of a test specimen, the pen on the recorder draws essentially a straight line, but when the test surface deviates in flatness, the stylus moves up and across a deposited resistor, for example, then drops again, and the recorder pen draws a greatly magnified representation of the same surface that's on the specimen.

**Table talk.** Company officials say of the critical stylus reference table only that it uses a low-friction bearing surface. A linear variable differential transformer senses stylus movement in the z axis, using a coupling that operates at 20 kilohertz. One microinch of movement can be amplified over a range of 10 times to 100,000 times before being recorded, which makes the deviations from the stylus reference point easy to discern on the recorded image. Wilson believes the instrument may be able to provide measurable data impossible to obtain with electron-beam microscopes. The machine provides x and y axis magnifications of 5, 10, 20, 50, 100, and 200 times.

These could be as great as the maximum 100,000 times z axis magnification, but Wilson says "we wouldn't have paper big enough to show it." The stylus force is 200 milligrams, and a typical 2-inch-by-2-inch specimen can be profiled in about 30 minutes, limited by the recorder speed. The Micro-Topographer will work with any recorder, Wilson says; Gould is using a Hewlett-Packard model,



# Catch the blip among the garbage.

The new IDR-200 instrumentation disc recorder is designed to isolate information for detailed analysis. It's great for catching and evaluating that one significant little blip among all the garbage. It's ideal for replacing endless loop instrumentation recorders, and its applications extend far beyond. In fact IDR-200 applications are only limited by the imagination.

## Unpredictable Transients

The IDR-200 is ideal for recording unpredictable events like powerline transients or radar signals. They can be replayed and analyzed for power, peak voltage, duration and other characteristics. The IDR-200 can be programmed to turn-off after the event is recorded and can operate unattended as long as necessary.

## Predictable Momentary Events

A rocket launch. The regular tape units begin. The shot's delayed, then fired. But, the tape ran out. Can't happen with the IDR-200. The recorder disc keeps recording 20-second blocks, continuously, until stopped.

## Event Comparison

On both single- and dual-channel recorders, a multi-track option allows recording of multiple 30 millisecond events. They can easily be replayed and compared because all are "synced." This capability is unequalled in applications where similarities and differences in test results are critical.

## Tape Analysis and Data Conversion

Volumes of telemetry or other data recorded on tape can be analyzed in detail by transferring portions to the disc for continuous replay. This data can then be repeatedly stepped through an A-to-D converter or a signal analyzer for noise reduction, signal enhancement and extensive manipulation.

## Delay Line

Imagine a 20-second, 2 MHz delay line. Or, a multi-channel, 30 millisecond, 2 MHz delay line. The IDR-200 can even be made into a programmed delay line.

## 1000 Hour Warranty

The DMI 1000-hour warranty on heads and discs is possible through outstanding manufacturing capability and advanced engineering achievements. All heads and discs are manufactured by DMI using proprietary techniques and outstanding quality control.

## Operation

The IDR-200 features DMI in-contact recording. Through perfecting this technical innovation DMI achieved high band-pass, short wave-length response and outstanding signal to noise ratios. Frequency response is from 400 Hz to 2 MHz,  $\pm 1.5$  dB midband.



The recorder is available in single or dual channel models. The dual channel model, stores 10 seconds of data on each channel. For more information, or assistance in applying the IDR-200 to solving your particular problems, contact DMI today.

The Disc People



1400 Terra Bella Avenue, Mountain View,  
CA 94040 (415) 961-9440 TWX (910) 379-6474



## U.S. Reports

the only component purchased outside.

**Control.** Because of the time required to make an image, Wilson foresees the instrument being used more as a process-control tool than a production-line inspection instrument, although it can pinpoint surface defects that might be missed.

### Commercial electronics

#### Where credit's due

Existing roller-type credit card im printers sometimes create as many headaches as they cure. Among them: sloppy imprinting jobs, carbonless forms that don't print at low temperatures, and the cost of optical character readers or key-punching needed to read data from the imprinted form back at headquarters. And, most proposed readers that would alleviate those pains require special credit cards.

A Massachusetts firm, Athena Systems in Bedford, says it has a solution that's not only inexpensive, but also uses existing plastic credit cards. Athena's system, labeled AS22, also promises real-time credit evaluation and transaction recording, or, in off-line applications, cassette recording of transactions to sidestep optical reading or keypunching.

The key word is "inexpensive."

In quantity, Athena Systems would sell a card reader for on-line applications, or reader-recorder for off-line use, for only \$99. And that's low—most of the imprinters found on clerks' stands and gas-station pump islands sell for \$80 to \$100.

The AS22 uses existing credit cards by reading the account number already embossed on the card. The firm has developed a seven-pin basic sensor, capable of reading the numbers embossed on more than 200 million of the 300 million-odd credit cards in daily use in the U.S. Almost all other card readers proposed need some kind to help on the card—say, a magnetic strip, or a set of embossed ferrite-filled lines—to operate. If these systems were put into operation, most existing credit cards would have to be withdrawn and replaced or modified.

**Mirror image.** To the user, an Athena Systems card reader would look much like any other; but beneath the account number position would be a set of sensors to read the numbers from the back—a seven-pin sensor for each number position.

While the card is depressed, and the transaction details are printed normally, the pins in the sensor array slide upward into the spaces behind the embossed numbers.

Figuring that most fonts use numbers based on a figure 8 shape,

Athena's sensor has a pin to fit into each bar in the 8. Where there's no bar, as in the middle of a zero, the pin is forced downward. This pivots a magnetized-metal strip—called a data mark—into contact with a magnetic tape or with a moving magnetic-pickup head.

Since there is a space on either side of each data mark, and a timing mark (which never moves and whose presence is always recorded) the recorded or detected output is bit serial, with a sync mark between every bit location, and can be read and transmitted asynchronously.

The cost of goods purchased also would be encoded digitally, with a keyboard or sliding switch controlling the data marks.

Athena has developed a special cassette for the off-line model. It has a 4-inch-long slit in one side enabling simultaneous recording of transactional data and account number. There's a shorter slit on one end providing room enough for a capstan pinch roller and playback head. Each cassette would hold up to a week's transactions for, say, a gas station.

### Materials

#### Well-made coat . . .

When Union Carbide's group of plastic films, called parylenes, was called to the attention of the semiconductor industry [*Electronics*, Sept. 15, 1969, p. 68], it was hailed as the missing link to plastic-packaged devices that would be acceptable for high-reliability applications. The point was that parylene could be used to keep moisture away from the chips that the material was passivating.

Then controversy about parylene erupted, with some saying it wasn't living up to its notices, particularly in the area of moisture protection.

But for now, the latest—and maybe last—laugh may be with the pro-parylene group. In mid-January, NASA's Electronics Research Center got the latest quarterly progress report on its parylene

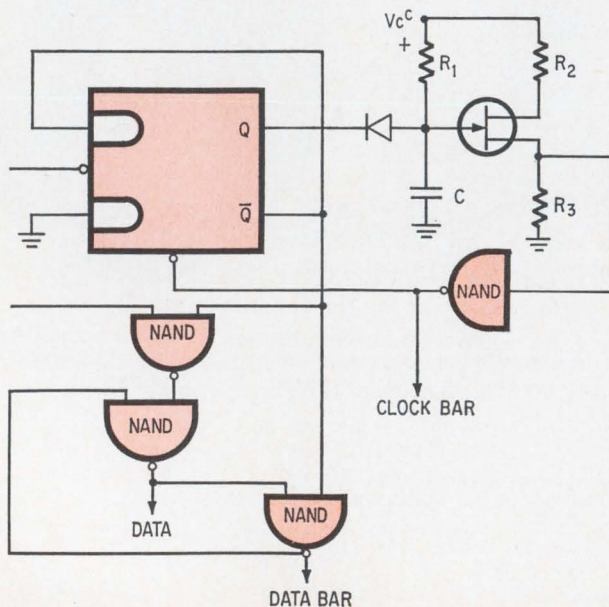

On time. Discriminator circuit for Athena's credit card reader. It separates clock from data pulses and uses Fairchild 930 diode-transistor logic.



# The Only UHF Planar Triodes That Guarantee 20 dB Gain Up to 1000 MHz with Intermodulation Better Than -52 dB\*



The outstanding linearity of our triodes allows the engineer to design TV transmitters and translators with the visual and sound carriers amplified through the same tube—exceeding FCC and CCIR specifications. 20 dB gain also permits driving these tubes with an all solid state exciter. All ceramic and metal construction assures long-life and reliability under severe environmental conditions. Thousands are in field use today at very low operational cost. These triodes are part of the most comprehensive line of UHF tubes available, ranging in output power up to 25 kW at 1000 MHz. A range of coaxial cavities is also available for UHF operation and assures the optimum performance of our tubes. For specific information please write or call your nearest Cain & Company representative, or contact us directly.

RATINGS	TH306	TH328
Heater Voltage (V)	5	5
Heater Current (A)	1.9	5
Anode Voltage (KV)	1.6	2
Anode Current (MA)	130	250
Power Output (W)	35	100
Intermodulation Level (3 tone test) (dB)	< 52	< 52

\*Three Tone Test

Discuss these tubes with us at NAB, Booth 229, West Hall, Chicago Hilton, April 5-8.



**THOMSON-CSF**

Thomson-CSF Electron Tubes, Inc./50 Rockefeller Plaza/New York, N.Y./10020

(212) 245-3900

See us at IEEE Show Booth 4G-22-24 New York Coliseum



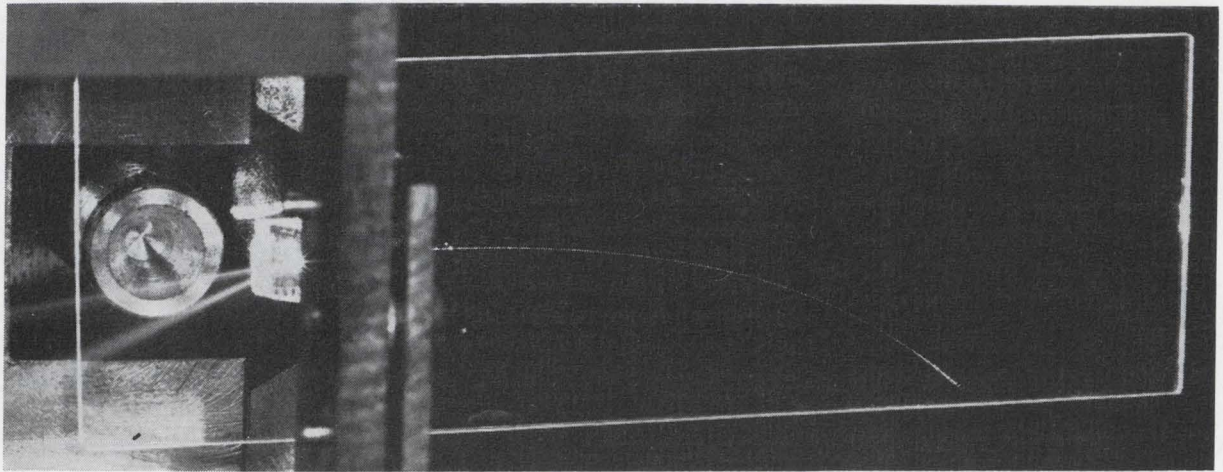

**Guiding light.** Everyone's heard of waveguides. Now Bell Telephone Laboratories has come up with a variation on the waveguide idea—a lightguide, a hairlike thin film strip that can direct, or manipulate, laser light in the same way a conventional electronic circuit manipulates an electrical current. Formed into complex optical circuits, lightguides behave like tiny tunnels with mirrors for walls. Glass or crystal films are used because conventional silvered mirrors would dissipate too much laser light. Although Bell is talking about signal-processing applications for everything from high-capacity communications systems to computers, the most obvious and immediate use for lightguides appears to be as filters in proposed underground laser-communication systems. Since one laser "pipeline" would carry many data channels, these optical circuits could be used to divide the beam into its component parts, feeding each channel of information into laser repeater elements.

tests at North American Rockwell's Autonetics division in Anaheim, Calif. And the results make parylene C (chloro-p-xylylene) look good. Using chips on headers, but coated with only 1.2 to 2.0 mils of parylene, Autonetics researchers James Licari and Stuart Lee appear to have put parylene C through its paces.

**Sweating it out.** Twenty-two chips, metal oxide semiconductor inverters, were placed in an 85°C, 85% relative-humidity atmosphere for 10 days with only parylene to protect them; the packages weren't capped. At the end of the tenth day the devices were checked for leakage current, voltage breakdown, and threshold—and none had changed parameters, except for one chip scratched in handling. After 16 hours at 175°C, there was some cracking of the parylene.

While NASA and Autonetics were testing the material, the Rome, N.Y., Air Development Center was putting devices of its own in a pressure cooker atmosphere. Joseph Brauer is said to have subjected parylene-coated packaged IC's to high pressure, high temperature, moist saline conditions and to have

achieved two to five times longer life just with this external coating. In one instance a failure mode which usually occurred in two to four days didn't appear for 40 to 50 days.

Irving Litant, a NASA center chief scientist, can't be an apologist for parylene because he's a Government employee. But he points out that its performance as a passivator could probably be improved further by applying normal hermetic or plastic packaging. At very high temperatures, and over extended periods, parylene will oxidize because the CH<sub>2</sub> bond at either end of the parylene monomer (the stage before polymerization) can be broken and link instead with free oxygen. This is probably the cause of the cracks mentioned in the Autonetics report.

### ... back at the lab

Union Carbide, the maker of parylene, doesn't seem to be making it easy for semiconductor makers to use the promising plastic. One potential user is thinking twice—he

found that he would have to pay a \$7,500 disclosure fee, an undefined royalty on each pound of parylene he used, plus a whopping \$250 per pound for the material itself.

The problem probably is understandable from Union Carbide's point of view. Large chemical firms can't make much money on small lots, and parylene sales for the whole electronics industry probably don't amount to much more than pilot-line production by Union Carbide's tank-car standards. A pound of parylene can coat a lot of IC's.

**Still better.** But now there are rumbles about a less defensible piece of inaction on Union Carbide's part. The firm appears to have suppressed word of a perfected form of parylene: parylene AF-4. So far its only mention has been in an obscure (to the electronics field) technical paper published last year. But the word is leaking out.

Parylene AF-4 has characteristics that make parylene C pale by comparison. It is safe over very long durations at 300°C or more; it can withstand temperatures up to and perhaps beyond 500°C;



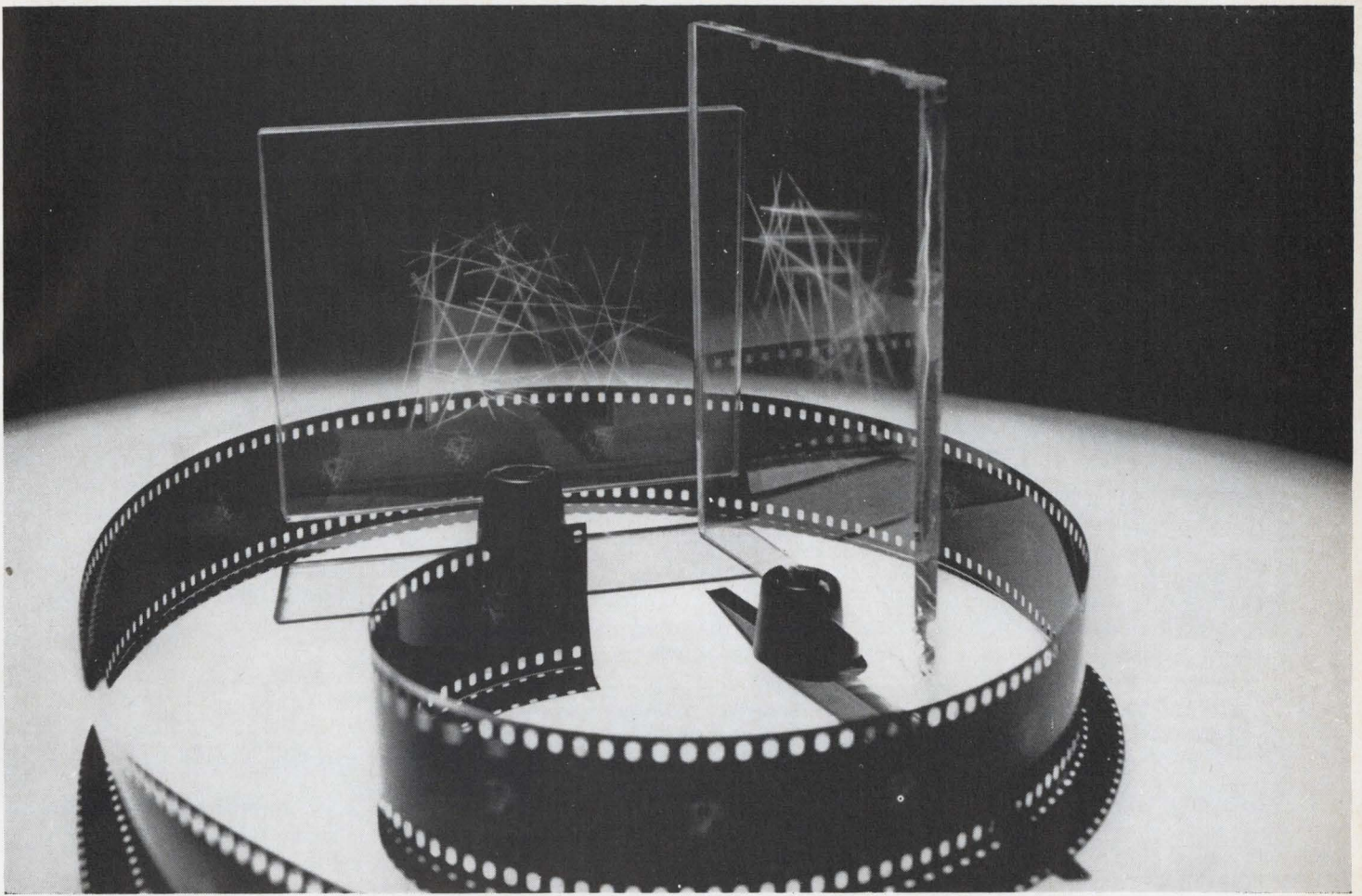

### Holography—quickly—by computer

One of the most startling things about a hologram is that it produces images with parallax... that the appearance of the image varies according to the angle of view, just as in the real world. That's why we see the subject in 3-D, even though each eye, looking along its axis through a separate small area of the hologram, sees only two dimensions. Bell Labs scientists M. C. King, A. M. Noll, and D. H. Berry took advantage of this to generate holograms of nonexistent objects (such as 3-D mathematical graphs) with a few seconds of computer time.

Normally, a hologram is made by photographically recording wavefronts of laser light reflected from a real object. (Holograms have also been generated by calculating such wavefronts and recording their pattern on a photographic plate, but this takes many hours of computer

time, even for simple subjects.)

A King-Noll-Berry hologram, however, is actually a series of holograms, each about 1mm wide and 100mm high, on a single holographic plate. These individual holograms are made, one by one, from a series of two-dimensional computer-generated pictures (film strip above), showing the hypothetical object from a range of viewing angles, in  $0.3^\circ$  steps. (Because of a hologram's high information capacity, each 1-mm vertical strip can contain—and project—a full-width picture.) And since each of the viewer's eyes looks through a different vertical strip, the viewer sees the object binocularly, in 3-D.

Like most holograms, these should be viewed with a laser; this limits their usefulness for many scientists, engineers, and students. But, because the "strip"-hologram images

are two dimensional, placing a holographic plate with a special emulsion in the plane of the projected real image yields a copy hologram (glass plates above). Viewable under an ordinary incandescent bulb, this hologram can be studied wherever and whenever the user wishes.

This technique is the first way to make "hard copy" holograms of imaginary solid objects with little computer time... a fast and inexpensive way of converting abstract data into three-dimensional pictures and graphs. It opens another avenue of fluent communication between man and machine, for possible use in communications technology, science, finance, architecture, statistics, and other fields in which the computer has become necessary.

**From the Research  
and Development Unit  
of the Bell System—**



**Bell Labs**



## U.S. Reports

(nearly 1,100°F); it won't oxidize like highly stressed parylene C even at temperatures like these—thus its stability and coating integrity is far greater than that of parylene C.

So far, Union Carbide has said as little as possible about parylene AF-4, and has denied its existence to some inquirers. To others it expressed horror that the secret was out. Whether the firm will sell the new material is a question right now; but if it does, the electronics industry would probably take to it more quickly than to parylene C since AF-4 promises a plastic passivation more stable than the silicon it protects.

### Meetings

#### Wave of the future

Least understood in terms of theory and devices, the submillimeter-wave portion of the spectrum—about 50 gigahertz to infrared—stands as the last untapped lode in the communications landscape. It may yet turn out to be the richest.

Operations with submillimeter waves should yield all the small-size advantages of optical wavelengths—and do it without the inherent instability and low efficiency of lasers. No pumping systems or mirrors are required. Modulating techniques, so difficult with optical signals, are essentially identical with lower-frequency electrical signals. In fact, all the well-established r-f technologies developed over the years—generating, mixing, amplifying, signal processing, detecting—can be applied directly to this area of the spectrum.

**Work ahead.** However, before submillimeter waves can take their place in communication systems, many uncertainties must be eliminated. Progress has been stymied by slow interchange of ideas and techniques between the laser people, who approach the technology from an optical viewpoint, and the microwave people, who see it in terms of microstrip and planar components. The result: submillimeter wave technology,

largely unexplored and unused, is limited by the lack of suitable components—efficient sources and sensitive receivers—and circuit techniques.

In an attempt to change this picture, the Polytechnic Institute of Brooklyn, through its Microwave Research Institute, in conjunction with the IEEE, is sponsoring a submillimeter-wave symposium to be held at the Hotel Commodore, New York City, March 31 through April 2. Both sources and detectors will be discussed, as well as such new-world technology as nonlinear and nonreciprocal interactions—nonlinear optics, magneto-plasma effects, and harmonic generations at very long optical wavelengths.

Because of its interest in millimeter-wave communication systems, Bell Labs has been working to develop sources operating at about 100 Ghz and above. Bell is working with both Impatt and limited space-charge accumulation devices, with the Impatts offering greater stability and reproducibility. Toshiro Misawa and L.P. Marinaccio will offer a paper on a 100-Ghz silicon Impatt diode intended for c-w operation at 0.1 watt levels.

**Look at lasers.** Taking another approach, long-wavelength laser sources are being developed, and both submillimeter sodium dioxide lasers and other lower-frequency gas lasers could make good communication sources as well. T. Y. Chang and T. J. Bridges of Bell have accomplished lasing action at 496 micrometers in optically pumped CH<sub>3</sub>F gas.

In still another approach, a group working at Tohoku University in Japan has generated both millimeter and submillimeter waves with a new electron tube design and a Fabry-Perot Resonator. This can mean a significant improvement in stability and simplicity over old electron tubes.

Among the detector papers, those on pyroelectric (heat-electrical converter) units may prove most significant because heat may be the most efficient way of detecting radiation at these suboptical levels. Again, Bell Labs is active, and recent improvements in the h-f performance of pyroelectric de-

tectors will be discussed by A. M. Glass and R. L. Abrams. Also in this area, E. H. Putley of the Royal Radar Establishment at Malvern, England, will give an overview of the progress made with pyroelectric detection.

A Josephson junction (the device that does everything) has been developed at the University of Rochester to serve as a 100-Ghz oscillator-mixer, and the details of its development will be presented. Because of their tremendous detection versatility, Josephson-effect devices may prove to be highly effective in the submillimeter range, especially for low-signal systems.

### Government

#### Pentagon vs. Lockheed

There's an interesting side effect to Lockheed Aircraft's notice to the Secretary of Defense that it cannot continue operations beyond the end of the year on such costly and controversial programs as the Air Force C-5A transport, the short-range attack missile (SRAM) propulsion system, and the Army's canceled AH-56A attack helicopter unless it gets more money. The request has frozen a Pentagon plan to order the Navy to cancel the remaining four of Lockheed's six scheduled deep-submergence rescue vehicles [*Electronics*, June 23, 1969, p. 70].

The latest recommendation to cut the DSRV from six craft to two came from Congress' economic watchdog, the General Accounting Office, whose new analysis of the rescue craft says program costs have escalated to \$463 million for six boats from an original estimate of \$36.5 million for 12. The new DSRV unit production cost is now forecast at \$27.5 million plus \$4.1 million in annual operating costs—increases of nearly 2,000% and 3,000%, respectively. Add on R&D and the unit cost averages \$77 million.

**Enough.** The two DSRV's now ready for test are viewed by most Congressional and some DOD sources as sufficient for Navy use



# The oil can for live wires.

It's the AC oil capacitor step-ahead electrical engineers are hooking up with.

We wrap it in terneplate steel then wrap the steel with a solid coat of paint to fight environmental corrosion. Double-roll the seams for a sure seal. And equip it with dual universal quick-connect terminals.

It's the best you can buy for room and central air conditioning. Great, too, as a starter that keeps working while the motor runs, continually correcting the power factor for maximum efficiency. Also filters power supplies for computers, business machines, industrial controls, phase shifting and fan motors.

Get the Mallory Oil Capacitor. Your best hook up for performance, reliability, and delivery. AC Capacitors are available direct, or from your Mallory distributor. Write for Bulletin 4-14.



**MALLORY**

**MALLORY CAPACITOR COMPANY**

a division of P. R. MALLORY & CO. INC.  
3029 E. Washington St., Indianapolis, Indiana 46206; Telephone: 317-636-5353

Electrical and electronic components • sequence timers • metallurgical products • batteries



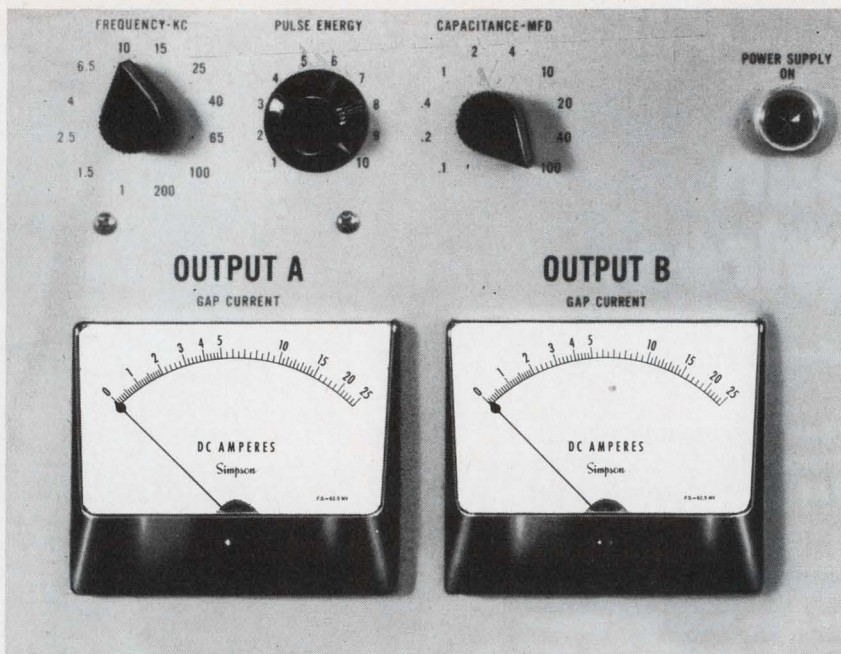

**the sure way to let  
customers know you  
care about quality...**

## **Simpson panel instruments on your equipment**

Simpson's advanced self-shielding annular and core magnet construction provides optimum torque-to-mass ratio. Rugged Taut Band and Pivot & Jewel movements can withstand punishing shock and vibration. Your assurance of an instrument that will *stay* accurate. No wonder so many manufacturers with reputations to protect (or build!) specify Simpson.

Over 1,400 stock ranges, sizes, and types. Get "off the shelf" delivery from your local electronic distributor.

For special needs contact your local Simpson Representative. He's ready to help.

**Simpson** ELECTRIC COMPANY



5200 W. Kinzie Street, Chicago, Illinois 60644 • Phone (312) 379-1121

EXPORT DEPT.: 400 W. Madison Street, Chicago, Illinois 60606. Cable Simelco  
IN CANADA: Bach-Simpson Ltd., London, Ontario • IN INDIA: Ruttonsha-Simpson Private  
Ltd., International House, Bombay-Agra Road, Vikhroli, Bombay

**INSTRUMENTS THAT STAY ACCURATE**

## U.S. Reports

—one operational and one backup unit—rather than the three two-boat systems proposed. The GAO notes that "since 1928, when the development of the McCann rescue chamber [diving bell] was initiated, there has been only one U.S. submarine disaster from which rescue was possible." That was the USS Squalus, which sank in 240 feet of water in 1939 and from which 33 were saved.

Present estimates are that \$200 million of the \$307 million now forecast as Navy costs between fiscal 1971 and 1974 could be saved by halting plans to produce the last four vessels.

The larger fiscal dilemma of Lockheed, the Defense Department's largest contractor last year, is getting limited sympathy in the capital. Secretary Laird notes the claim, in a letter from Lockheed chairman Daniel J. Haughton to Deputy Defense Secretary David Packard, is "extremely serious." But Laird also notes that there is about a \$1 billion difference between what the Pentagon says it owes the company and Lockheed's contention. Laird's initial reaction that the problem would not be resolved before thorough Pentagon and Congressional reviews suggest he is not about to be pushed.

## Companies

### Too small share

System Development Corp., the large software company (\$61 million annual sales) that made the switch from nonprofit to profit organization last year [*Electronics*, Sept. 15, 1969, p. 151], is toning down plans to move into the commercial end of the business. The prime vehicle for enlarging its miniscule nongovernment business (less than 3%) was its Time-Shared Data Management System, an IBM 360/67 in Santa Monica, Calif., and a 360/75 in Falls Church, Va. But, though 70 to 75 companies are using it, growth and profits weren't up to expectations. Like other time-sharing outfits, SDC faced tight money, tight defense dollars, and



# Honeywell is out to clear the air in a lot of dirty businesses.



Stale smoke, dust, grease particles, pollen and other airborne filth are the enemies of all businessmen, from restaurant managers to machine shop operators. So, Honeywell has developed a new business machine that fits into your heating or cooling system and removes up to 95% of the impurities from the circulating air.

We call our self-washing electronic air cleaner a business machine because we sell it on a very business-like basis. **IT CAN SAVE YOU MONEY.**

In a retail business, the relationship between cleaner air, less maintenance, cleaner merchandise (or food) and more customers is pretty obvious. But it's hard to measure. So, here's a more measurable saving that applies to *any* type of business.

**Business machine cuts heating, cooling, ventilating costs.** Any ventilation system uses outside air—often polluted. A regular ventilating system must run almost continuously to replace stale inside air with only partially filtered outside air—a substantial operating expense. The Honeywell Electronic Air Cleaner cleans and reuses more inside air . . . the air you've already heated or cooled. That's a saving anyone can measure.

**No maintenance on the machine, either.** After it cleans the air, it cleans itself . . . automatically. Businessmen don't need more maintenance problems.

If you'd like to know more about Honeywell's new business machine, the self-washing electronic air cleaner, just mail the coupon. If we can't make a businessman's case for saving you money, we'll just leave quietly.

Mail to:  
**Honeywell, Dept. 118**  
**Minneapolis, Minnesota 55408**

I'm interested in more information about your Automatic Wash Electronic Air Cleaner.

- Please send new brochure.  
 Please have a representative call.

Name \_\_\_\_\_

Business \_\_\_\_\_

Address \_\_\_\_\_

City \_\_\_\_\_

State \_\_\_\_\_ Zip \_\_\_\_\_

**Honeywell**  
A U T O M A T I O N



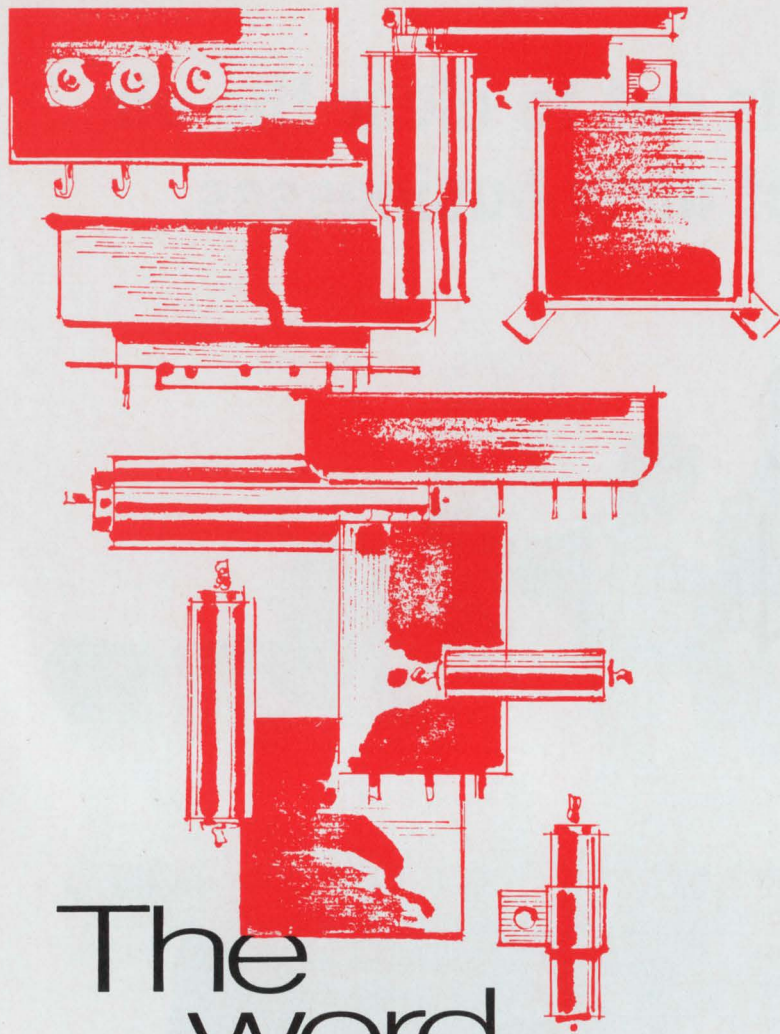

The  
word  
is filtering  
down...

## Captor is capable

Captor is the bright new face in electronic components, particularly filters. Deeply experienced. Imaginative. Capable of producing miniature EMC filters, communications and security filters, custom design filters/assemblies, and other electronic components. Capable too of fast delivery, competitive prices, testing, research. Capable of handling any size RFI/EMC filter order. Has the good word about Captor reached you yet? Write for our capabilities brochure today!

 **CAPTOR**  
CORPORATION

Electronics Division

5040 Dixie Highway, Tipp City, Ohio 45371, Phone: (513) 667-8484

## U.S. Reports

industry capacity rising faster than could be absorbed by users. So SDC has decided to get out.

What does this mean to SDC's commercial data-management system, a leading management information system? SDC replies that its decision is no reflection on that setup, and that it's trying to convert time-sharing customers from hourly use (service center) to outright lease or purchase of the program. "We originally thought of selling it both ways," says a spokesman.

As far as the computer centers are concerned, the one in Santa Monica will be used for outside batch processing and in-house software research. The one in Falls Church may be closed.

### For the record

**Fini.** The Cogar Corp. has settled its lawsuit with IBM over the alleged use of IBM trade secrets. Terms of the settlement were not revealed beyond the fact that the two companies had entered into a cross-license agreement. IBM initiated the suit last fall.

**Footsteps.** A second source for users of Digital Equipment Corp.'s popular PDP-8 series of minicomputers has become available in the shape of the DCC-112, by Digital Computer Controls of Fairfield, N.J. It is said to be the first minicomputer on the market that is completely compatible with another, both in hardware and software. Selling for \$5,900 for a stripped-down model, or about \$14,000 for an average system, it's claimed to be 25% faster, smaller, cooler, more reliable, and easier to maintain.

**Waste.** Viatron, which signed what could have been a multimillion-dollar contract with Collins Radio Co. of Newport Beach, Calif., for use of Collins' "C-System" computer-aided MOS design scheme, has pulled back from much of the deal. The stated reason is that the Collins CAD approach wastes real estate.



# NEW AUTO-POLARITY FET V-O-M SPEEDS TESTING

You've probably imagined the convenience and time-saving you'd enjoy if you could just clip one of the V-O-M leads to ground or to the chassis, and have your meter always read upscale regardless of the polarity of any other terminal you touched.

No need to imagine it any more . . . you can see it and try it right now at your Triplet distributor. Called the Triplet Model 602, it's probably the most convenient V-O-M ever built. Its convenience goes well beyond the auto-polarity feature, though . . . to AC and DC measurements from 10 mV to 1000 V in 8 ranges at 11 megohms DC and 10 megohms AC input resistance . . . AC and DC from 0.02 to 1000 mA in 4 ranges . . . resistances from 0.2 ohms to 1000 megohms in 6 ranges. And with an accuracy of 3% on voltage measurements, and a rugged suspension-type meter movement, the Model 602 has what it takes to make your job easier.

This great new V-O-M is available at your Triplet distributor for **\$100** suggested USA user net. For more information, or for a free, no-obligation demonstration, call him or your Triplet sales representative. Triplet Corporation, Bluffton, Ohio 45817



*The World's most complete line of V-O-M's . . . choose the one that's just right for you.*

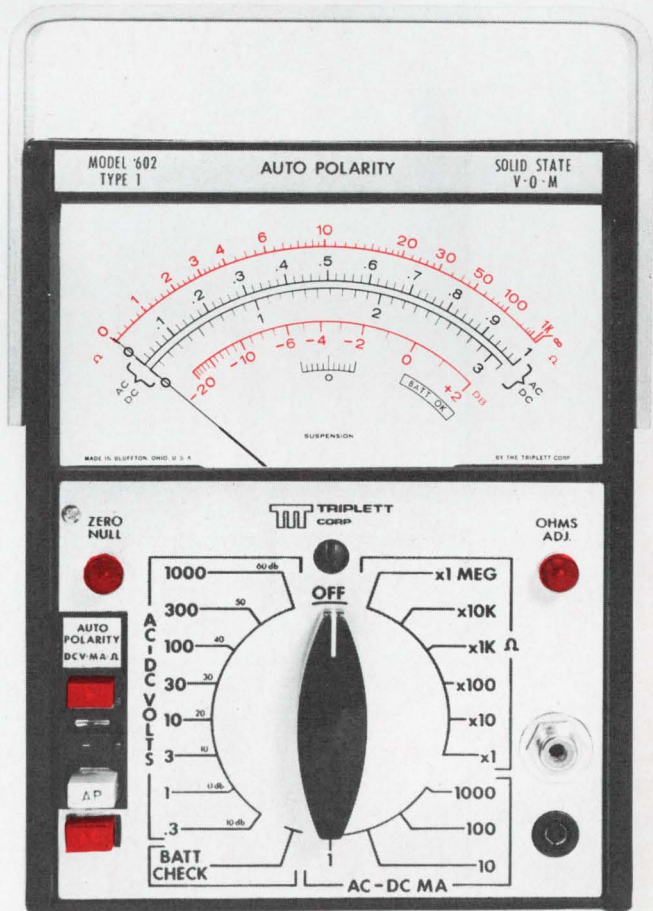

1. Auto Polarity . . . convenient and time-saving; creates memory and suppressed scale.
2. High sensitivity (.3V AC and DC) at constant 11 megohms input resistance.
3. Simplified scale with only 2 arcs for 24 AC/DC ranges.



# HELIAX COAXIAL CABLE...

the ultimate  
in high power  
performance

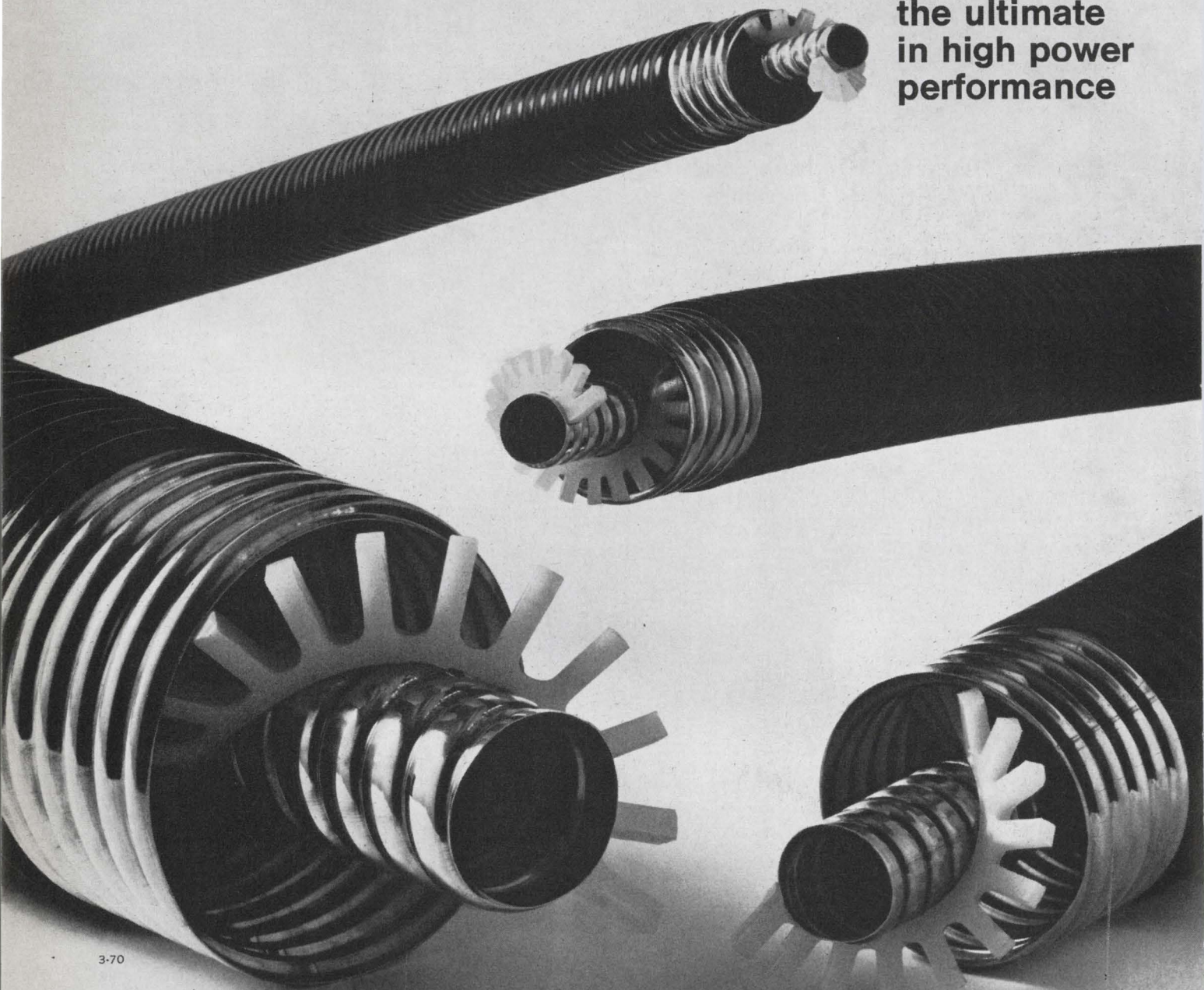

3-70

The one cable that has all the advantages for transmission of high power RF. One piece connects transmitter to antenna. Eliminates the numerous flanges and bullets of rigid systems. HELIAX is easiest to plan. Easiest to install. Most reliable.

Corrugated conductors eliminate the differential expansion problems. Cable can be clamped directly to tower, buried directly in earth.

Standard types and sizes up to 8".

Communicate with Andrew.

 **ANDREW**

ANDREW CORPORATION, 10500 W. 153RD STREET, ORLAND PARK, ILLINOIS 60462, PHONE (312) 349-3300



---

# International Newsletter

---

March 16, 1970

## Europeans gain edge in air-traffic control satellite project

Backers of a transoceanic air-traffic control satellite system based on France's L-band Dioscures project are cheered by results of a recent Paris meeting of the International Civil Aviation Organization's Astra panel, charged with defining the system. "L-band has won," proclaimed a jubilant European delegate following the conference. American aviation officials, who generally favor the vhf or hybrid vhf-uhf systems developed by RCA and TRW, agree that "the French now have room for optimism," in the words of an FAA official.

Though the mission of an experimental ATC satellite, a pair of which would be launched in 1974 to squeeze more planes into the crowded North Atlantic air lanes, is fairly well defined, operational frequency has been a basic stumbling block up to now. But, technical reports accepted by all sides at the Paris meeting showed that the 1,550-megahertz uhf band offers better performance in virtually all parameters.

An official of ESRO, the European space agency which has been discussing the ATC system with NASA since last June, called the Paris findings "the first real breakthrough for L-band." Though the Astra panel made no hard recommendations, its report is expected to carry great weight at the May meeting of an ICAO commission in Montreal that is to plot the project's future.

But the U.S. side is simply not convinced that uhf is the best bet. One American delegate, while admitting the hybrid system was "not received with open arms," said "we'll continue to press for one," preferably over the Pacific. He added, "the Europeans don't have any money to get things done, it'll be our money."

## Ion-implantation subsidies pay off for Japanese

Hitachi has developed a prototype ion-implantation machine for large-scale production of semiconductors. In 1968 Hitachi received a subsidy from the government-sponsored Research and Development Corp. of Japan to develop implantation production techniques. At the same time, rival Toshiba received a subsidy for developing state-of-the-art transistors using ion-implantation techniques [*Electronics*, Nov. 25, 1968, p. 143]. Toshiba revealed its success last year [*Electronics*, Sept. 15, 1969, p. 226]—and now it is Hitachi's turn.

The ion-implantation unit can be loaded rapidly with a cassette that holds up to nine 2-inch diameter wafers in a horizontal position. Beam sweep makes it possible to fabricate devices on all nine wafers simultaneously. Throughput is about 40 wafers an hour.

## TI to push new linear IC's in West Germany

Texas Instruments is set for a big push into the lush German market for linear integrated circuits. Its German subsidiary is starting to deliver sample circuits to prospective German customers right now and expects mass production to begin in only a couple of months.

The company's move in Germany is the first step into a brand-new market sector. However, some industry insiders say it may not find the going in Germany all that easy. Formidable competition will come from Valvo, a Philips subsidiary, which already has a firm grip on the linear IC market there. They point out, though, that the market is only just beginning and is almost insatiable as more and more consumer electronic equipment makers and car manufacturers turn to integrated circuits.



---

# International Newsletter

---

## Red-light diode from Japan shows negative resistance

The Sharp Corp. claims to be the first in the world to produce a visible-light-emitting diode with negative resistance. The diode is a follow-up to the company's infrared-light-emitting diode with negative resistance [*Electronics*, Aug. 4, 1969, p. 229]. Radiated output from the new diode is centered about 6,800 angstrom units—an intensely bright red.

The new diode is fabricated by a liquid-phase epitaxy process from gallium aluminum arsenide—a material used by others for visible-light-emitting diodes, but not previously used by Sharp. The device now is in final phase of research, but the company has not yet completed plans for bringing the diode to market. However, it may add an extension onto its soon-to-be-completed semiconductor plant—which will produce MOS arrays under license from Autonetics—for production of the new diodes.

Applications for the new diode will be largely in alphanumeric and graphic displays. Switching, amplification, and memory capabilities inherent in the diode will simplify and reduce circuit costs by eliminating need for these capabilities in the driving circuits. What's more, the diode will directly interface with most circuits that might be used to drive it—it has a relatively fast response time on the order of 100 nanoseconds.

## East Germans falter in integrated circuits

While other East Bloc countries—notably the Soviet Union and Czechoslovakia, which displayed transistor-transistor logic circuits—are well along in integrated circuits, IC's were conspicuously missing from East Germany's stands at this month's Leipzig Spring Fair. This surprised many electronics experts, since the East Germans made a promising start some time ago. For example, they switched over from germanium to silicon technology long before many West European firms did.

The East German lag in IC's stems from some serious production problems. With a lack of advanced types of manufacturing equipment and a shortage of good base materials, only a small percentage of circuits can be considered good enough for equipment application. There's still another factor: contrary to expectations, East European countries that are already well along in IC production are far from willing to share their know-how with Comecon partners, one West German expert says.

Despite these difficulties, IC's are expected to be seen at East German stands at next spring's Leipzig Fair. Most likely, they'll show up with digital types of the TTL variety—circuits suitable for industrial electronics equipment which the East Germans are emphasizing so strongly.

## Intelsat compromise nears negotiation

The first break in the deadlock over permanent agreement for operation of the International Telecommunications Satellite Consortium has come in Washington. With British acceptance of a Japanese-Australian compromise proposal, the U.S. appeared willing to negotiate the plan. Basically the compromise calls for the establishment of a director general, who will conduct a six-year operations study while the Communications Satellite Corp. continues as Intelsat manager.

The major sticking point for the U.S. is that the plan would mean a reduction of its voting power, now based on system usage, to about 40%. U.S. votes started out at 53%, but are now down to about 48% as new ground stations of member nations come on line. Recognizing that its voting share would continue to decline, the U.S. is reportedly willing to negotiate, provided that agreement also comes from France, Switzerland and West Germany, nations still opposed to Comsat management.



# Strain-gage cartridge tracks with a brace of MOS FET's

French cartridge, a prototype design, poses a strong competitive threat to standard magnetic units; transistors on needle shaft act as built-in preamplifier yielding total output power of 55 millivolts

**Attractive mass** and sensitivity characteristics make strain-gage phono cartridges an interesting alternative to standard magnetic cartridges. Those developed up to now, though, haven't carried these advantages far enough to jar magnetic-cartridge makers out of their groove.

A new prototype strain-gage unit designed by France's Sescosem and announced at last week's Paris hi-fi show could give the necessary shove. While other such cartridges use semiconductor resistors to translate a needle's mechanical vibrations into electrical impulses [*Electronics*, Sept 15, 1969, p. 255], the French cartridge puts the strain where it can do the most good: across a brace of field effect transistors, neatly deposited on two tiny silicon bars connected to the needle shaft.

This system gives the cartridge a built-in preamplifier, letting it be hooked directly to a power amplifier and thus eliminating several amplification stages—an important cost advantage. Sescosem's cartridge puts out 200 millivolts of power, which is upped to 500 mv by another MOS transistor placed behind each channel to cut output impedance from 50,000 to 10,000 ohms. In contrast, magnetic cartridges typically put out only 6 mv. Strain-gage designs generally manage around 10 mv.

**Faithful.** The French cartridge manages this power performance while reproducing music as faithfully as all but the highest-quality magnetic cartridges. Sescosem engineers are working on a more advanced version that would equal

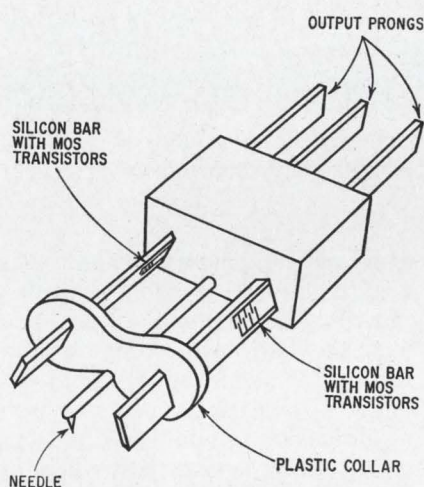

**Musical strains.** Silicon bars have two MOS FET's (shown stylized) each.

and possibly surpass top magnetic-cartridge performance, says Christian Jund, the engineer in charge of the project.

When Sescosem launched its strain-gage cartridge project six months ago, its engineers were not dreaming of elbowing out magnetic cartridges, but of finding a cheap, medium-quality cartridge for the \$400 package hi-fi sets that are winning a growing share of European markets. Since 1962 the company has been studying the influence of mechanical strains that limit carrier speed in semiconductors. Tying the amplifying abilities of MOS transistors to the current-varying prowess of a silicon strain gage turned out to be an ideal marriage.

Design of the Sescosem cartridge is surprisingly simple. Two silicon bars measuring 12 by 1 by 0.2 millimeters—one for each stereo channel—are anchored at the rear

of the cartridge. At the front, they're free to move whenever the tracking needle transmits vibrations by means of a plastic collar that connects the needle to the silicon bars.

**Duo.** Two MOS transistors are deposited on each bar. One transistor serves as a transducer to produce an electrical signal, while the other acts as a load resistor controlling the first. Sescosem has patented this arrangement and says its cartridge is the only one to combine transistors with a strain-gage effect.

Dynamic mass is 0.7 milligrams, with pressure on a record only 0.75 grams. Frequency response is zero to 30,000 hertz. Compliance is  $10^{-5}$  centimeter/dyne, a figure Sescosem engineers hope to improve.

One problem is the cartridge's signal-to-noise ratio, which now stands at 40 decibels. Jund says it will easily rise to 45 db with improvements in the present design; but he hopes to apply research on the origins of MOS noise to the cartridge and achieve a much better ratio ultimately.

## New role for Aida

France's aggressiveness in selling fighter planes to the Third World opens some enticing sales opportunities to French electronics firms.

One company anxious to cash in on them is Electronique Marcel Dassault. The firm has tailored a new fire-control radar especially for underdeveloped countries: it offers big-league performance in a simple,





**Leitmotiv.** The light weight and small size of the Aida-2 fire-control radar allow easy fit in nose cone of Mirage or other light interceptors.

reliable package that can be easily maintained by even ill-trained technicians of recently formed air forces.

EMD officials feel the new radar is just the thing to equip, for example, some of the 110 Mirage fighters that French President Georges Pompidou has promised Libya. Moreover, the pint-sized unit is compact enough to fit existing planes that weren't designed to accept radar. The French firm thus plans to seek out Afro-Asian nations that possess Northrop F-5 or other light interceptor planes and are anxious to beef up their air defenses without having to order new aircraft.

The company's new entry into the Third World arms race is an X-band radar called Aida-2 that weighs a mere 66 pounds. It follows Aida-1, a bulkier unit that EMD came out with a decade ago. The new cylinder-shaped radar is only 2 feet long and 10 inches in diameter. Company officials call it the world's most compact fire-control radar.

**Product design.** It is also one of the most potentially reliable and easiest to service of the radars. EMD designers tried to eliminate most of the possible headache sources. Use of a fixed antenna—while limiting scope—means the radar has no motor to fail. Instead

of a failure-prone crt, the unit uses a gyro-gunsight with head-up display. Aida-2 contains a solid state local oscillator instead of a klystron tube. This substitution greatly reduces power requirements as well as increasing reliability. Aida-2 operates on less than 600 watts at 200 volts a-c and less than 30 watts at 28 volts d-c. It puts out 100 kilowatts of peak power.

The new radar's electronics are entirely solid state, except for the magnetron in its modulator-transmitter. Some 100 hybrid IC's using EMD-developed thick-film ceramic components and an equal number of discrete transistors are contained in Aida's modular, plug-in subassemblies. These assemblies include tracking circuitry, strips, low-voltage power supply, and four other functions.

**Trouble-shooting.** A seven-test indicator isolates the problem to one of these seven subassemblies. The offending assembly can then be removed in a few minutes and a new one substituted. No new adjustments are necessary after such a switch.

The entire radar, in fact, can be removed from its mounting in the nose of an aircraft and be reinstalled without adjustment. Once the all-important boresight adjustments are made, the radar's retaining collar is set for good. Mainte-

nance crews need only attach two electrical connections.

Splitting up Aida's electronics into subassemblies enables EMD to offer several options without production difficulties. The unit is available as a range-only radar that simply displays the distance to a target. In more complex versions, the target is shown as a blip on the gyro-gunsight display and the pilot can follow the target by superimposing the blip on an azimuth-elevation cross.

In sophisticated versions, a firing-prediction unit gives the pilot information on gravity drop and azimuth correction needed to hit the target. A light goes on when the radar finds a target, followed by another light when the pursuing plane is within firing range. The display blip then corrects automatically for gravity and changing target azimuth.

## Great Britain

### Masking by hologram

Every time a microcircuit mask touches a wafer, the mask wears a little, limiting its life. Noncontact optical projection helps, but that technique only works well on small slices, because it's hard to achieve high resolution away from the center of the image.

Images made by holographic projection, however, can be completely free of aberrations, and for two years scientists at the Services Electronics Research Laboratory (SERL) have been investigating methods of using a hologram for putting mask patterns on a slice.

So far, they've proved that it can be done—but not under conditions that are likely to be acceptable to commercial microcircuit makers. The basic problem is that present photoresists don't respond quickly at the peak wavelength of present lasers, nor do lasers put out high enough power at the peak response wavelength of present photoresists. Mike Beesley, in charge of the work, doesn't see the two technologies meshing soon.

In his experimental equipment,



Beesley uses the output at 4,579 angstroms of an argon-ion laser to make and reconstruct the hologram. This is not the peak power wavelength, but it's the most powerful wavelength that also lies in the response spectrum of the resists that are most widely used in microcircuit making. The present argon-ion setup produces about 140 milliwatts at that wavelength, and it takes several minutes to expose a pattern on a slice.

The apparatus, which was on show at the Physics Exhibition in London earlier this month, has two parts. One makes the hologram from a master mask and one reconstructs the hologram as a real image. The same wavelength and accurately plane wavefronts are used in construction and reconstruction, so the image is the same size as the original. For reconstruction, the hologram plate can be easily reversed in its holder, but its faces have to be perfectly parallel.

The hologram is recorded in photoresist, not emulsion. Beesley has found photoresist gives him good efficiencies—around 20%. Similar efficiencies could be ob-

tained with bleached emulsions, but Beesley says they have practical disadvantages—they can't be used for reconstruction by reflection. Beesley intends to develop his system into reflection mode, which will restrict the tight tolerances to only one face of the hologram plate.

The construction equipment uses six separate, non-diffusing beams to make six same-size hologram images of the mask, evenly distributed around the periphery of the plate. Dust in the atmosphere and other environmental aberrations will make any one image imperfect. However, each will have imperfections in different positions. During reconstruction the six images are superimposed on the photoresist one after the other, cancelling the imperfections.

To obtain six images, a laser beam is widened to 8 inches. The beam passes through 12 holes in a disk: six around the periphery for object beams, six around the center for reference beams. Plane mirrors then deflect each object beam through the master mask and on to the hologram plate at the point illuminated by one of the refer-

ence beams. Hence, six holograms are formed simultaneously.

In reconstruction, the laser beam is expanded to a 2-inch diameter, and the central 1-inch-diameter uniform portion is passed through a rotating rhomboid prism to scan the six holograms in sequence. The beams converge to produce real images at the same point.

International

What's your attitude?

To succeed in space, everyone agrees, you have to have the right attitude. If your satellite's solar cell panels don't find their place in the sun, you'll soon be short on power. And if its antennas aren't pointed toward the earth, your satellite's muted.

Small wonder, then, that developing the right attitude, and keeping it, emerged as a key topic as some 300 experts in space control systems huddled in Toulouse early this month for the third symposium of the International Federation of Automatic Control.

One way to keep a satellite fixed in space is simply to spin the whole airframe; at the same time, the antennas are despun mechanically or electronically to keep them on target. This is the scheme used in U.S. communications satellites put into synchronous orbit. But it does not appeal to the Russians, whose Molniya-1 communications birds circle at medium altitude.

**Spinning wheels.** In a paper prepared for the symposium, B.V. Raushenbakh of the Russian Academy of Sciences explained how Molniya satellites are kept in position using a single hardworking gyroscope. It serves as a stabilizer, an angular rate sensor, and a rotation-damping device. Paired with thrust jets, the system keeps the solar cells pointed toward the sun with an accuracy of 10°.

But a higher order of precision—between 0.5° and 1°—is needed to keep the antennas pointed at the ground stations. This is effected through a trio of photo sensors, which sight in on the illuminated

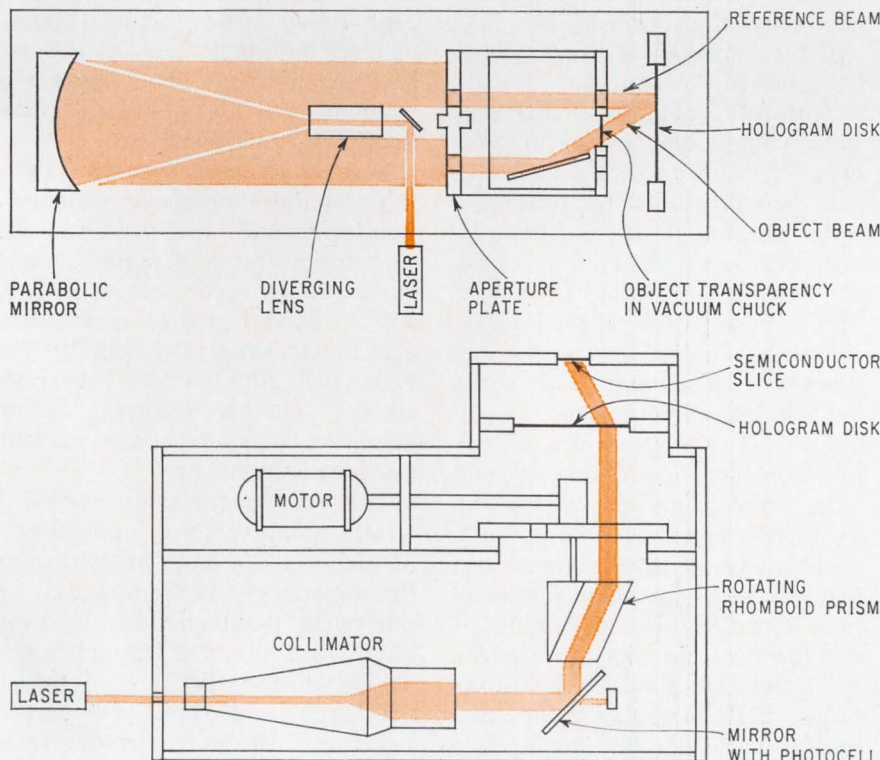

Coding and decoding. SERL's microcircuit mask-making equipment has two parts. Unit at top produces six holograms and unit below reconstructs image.



crescent of the earth. Their outputs control the antenna drive motors.

Spin stabilization also isn't used in the Franco-German communications satellite *Symphonie*. *Symphonie* will be kept pointed toward Europe by a motor-powered flywheel with an occasional assist from thrust jets. The system, Armin Brauch and Klaus Wekesser of Messerschmitt-Boelkow-Blohm GmbH told the Toulous meeting, is designed to keep the antenna within  $0.5^\circ$  of its nominal position.

The flywheel loop alone works continuously in the Boelkow system and it controls pitch. Roll and yaw corrections are handled by jets controlled from the ground, but they'll be made once a day.

Position inputs for attitude corrections originate in infrared sensors that scan the earth's horizon with an accuracy of  $0.5^\circ$ . A high-gain motor amplifier powers the flywheel, speeding it up or slowing it down according to the sensor signal. If a speed change of more than 10% is necessary, a gas-jet loop takes over.

**Makes sense.** Building earth horizon i-r sensors accurate to  $0.15^\circ$  probably won't turn out to be a hitch for Boelkow's satellite people. But if they do run into unexpected difficulties, they will know where to turn. Sensors that pinpoint the horizon with an accuracy of  $0.06^\circ$  have been developed by Barnes Engineering Co. Robert W. Astheimer, a Barnes vice president, told the meeting that the sensor was slated to go into the shuttle vehicle that will one day tend U.S. space stations.

It's only sensible to stay in the stabilizing whirl, in the opinion of some space control designers, among them Harry Kowalik of Canada's Communication Research Center. The ionospheric research satellite *Isis B* that is slated for a late 1970 launch will have the same control system as *Isis A*, even though the orbit this time will be circular instead of polar and the changes of the spin axis will be frequent. The system—based on current in two 108-turn aluminum coils interacting with the earth's magnetic field—worked so well it will go up again unchanged.



**Seeing double.** Standard 12-inch color tube is used in Toshiba's colorphone for seeing caller; a 3-inch black and white tube monitors outgoing image.

## Japan

### Smile, you're on colorphone

Using a new color tube, Tokyo Shibaura Electric Co. has developed what it claims to be the first color television telephone in the world—just in time to go on display at Expo 70. One pair, connected by a local transmission line, will be displayed at the Toshiba-IHI pavilion.

Toshiba's colorphone also uses some components found in ordinary television receivers, including a 12-inch shadow-mask tube as a color monitor. There is also a 3-inch black-and-white picture tube for viewing the transmitted image. The camera lens is located alongside this monitor, just above the color tube. The unit is 21 inches high and 23 inches wide.

The key to a successful color tv telephone, however, is development of a simple, inexpensive camera. Toshiba's camera is built around a descendant of the vidicon and features excellent color reproduction—especially in red response—and low cost, through an improved semiconductor film on the tube's target. Toshiba engineers note that the film differs from those used in vidicons and Plumbicons, but won't say more until they officially unveil the new camera tubes themselves

in Japan in a couple of months.

The new camera tubes also have very good sensitivity—they're designed for operation with an ambient illumination of 1200 lux, about 110 foot candles. This is about half the illumination used in color studios and less than that found in many offices. The camera could be adjusted for the fluorescent lights used in most commercial buildings, but at present, two incandescent flood lights are used to provide standard color temperature illumination.

The color telephone uses a two-tube separate-luminance configuration functionally similar to that developed by the government broadcasting system [*Electronics*, Feb. 6, 1967, p. 103]. Toshiba's camera has simplified optics and circuits for lower cost. Highly stable color processing circuits maintain color balance over long periods without need for adjustment.

The color signals are standard NTSC signals with a 4-megahertz bandwidth. Although in the future the signal may be compressed or otherwise modified for narrower bandwidth, the NTSC signal is desirable during the early developmental phase of color tv telephones because it can be transmitted over existing long-distance facilities as well as over local non-repeated coaxial cables.



# LINEAR

Linear Integrated Circuit technology is happening so fast, it's difficult to determine which development to advertise first. So, we've decided to advertise everything at once. As it happens.

Every month, you'll see this weird-shaped ad in the trade press. It will include new product announcements, applications, marketing decisions, assorted breakthroughs, a design contest, what-have-you. Sort of a something-for-everybody compendium of LIC information. If you see something you like, write us and we'll tell you more about it.



# New Product Digest

In addition to the  $\mu$ A715 and  $\mu$ A725, Fairchild is introducing the following new Linears:

- $\mu$ A731 **Dual Channel Sense Amplifier**  
2mV Threshold Accuracy  
5nSec Strobe Time Variation  
Internal Memory Data Register  
Reader Service Number 330
- $\mu$ A735 **Micro Power Amplifier**  
100 $\mu$ W Power Consumption  
2nA Offset Current  
 $\pm$ 3V to  $\pm$ 18V Supply Voltage  
10M $\Omega$  Input Resistance  
Reader Service Number 331
- $\mu$ A739 **Dual Low Noise Op Amp**  
1 $\mu$ V<sub>rms</sub> Noise (20Hz to 150KHz)  
50 $\mu$ A Offset Current  
20,000 V/V Voltage Gain  
Reader Service Number 332
- $\mu$ A742 **Zero Crossing AC Trigger**  
Operates from AC or DC Supply  
2 Amps Peak Output Current  
Time Proportioning Operation  
Adjustable Hysteresis  
Reader Service Number 333
- $\mu$ A747 **Dual Internally Compensated Op Amp**  
Short Circuit Protected  
Latch-up Proof  
Offset Voltage Null Capability  
 $\pm$  30V Differential Input Voltage  
200,000 V/V Voltage Gain  
Reader Service Number 334
- $\mu$ A748 **High Performance Op Amp**  
Short Circuit Protected  
Latch-up Proof  
 $\pm$ 30V Differential Input Voltage  
200,000 V/V Voltage Gain  
Reader Service Number 335
- $\mu$ A749 **Dual Op Amp**  
92dB Voltage Gain  
20MHz Bandwidth  
Latch-up Proof  
Short Circuit Protected  
Reader Service Number 336

## EDITORIAL

# If We Can't Sell You Ours, We'll Sell You Theirs.

For a long time, Fairchild built only linears designed by Fairchild engineers. We didn't think anything else was worth the effort. People said we had an NIH (Not Invented Here) complex. And, they were right.

However, it's been brought forcefully to our attention that a couple other guys in this business know what they're doing. The competition is coming out with some pretty worthwhile linears. Our customers have noticed too, because they're talking to other manufacturers about linears we don't make. They're even talking to sole sourcers!

To keep things even, we've decided to give our wandering customers something they're going to need if they start dealing with a sole source linear maker: A second source. Us. (Just in case the original supplier's factory blows up or they lose the formula or whatever it is that happens when you can't get delivery.)

Starting now, Fairchild is introducing a new line of linears. We call them IT circuits (Invented There). The first two are available today: The LM101 and the MC1495. Soon we'll add the LM101A, MC1496 and the SN7524. Of course, we've given them Fairchild part numbers. Here's a conversion chart:

$\mu$ A795	Analog Multiplier	MC1495
$\mu$ A796	Modulator	MC1496
$\mu$ A748	Operational Amplifier	LM101
$\mu$ A777	Operational Amplifier	LM101A
$\mu$ A761	Sense Amplifier	SN7524

There will be other additions to the IT line soon. So be sure you contact your local Fairchild Sales Engineer before you drop a design for lack of a reliable alternate source. Just give him the part number you want and ask him to check the IT line. Farewell NIH.

Reader Service Number 337

## Contest

Last year, Fairchild gave a series of seminars on Linear Integrated Circuits in which we introduced 12 new products. One device, the  $\mu$ A742 TRIGAC Zero-Crossing A.C. Trigger, was so significant we offered a free sample to anyone who came up with an original application for it. We got hundreds of replies. The most ingenious was sent in by Richard M. Burkhart, a graduate student at the University of Illinois. We liked Richard's application so much, we decided to give him \$100. Then, we liked the \$100 idea so much, we decided to make it a contest.

Here's how it works:

- 1) Get all the facts on a Fairchild Linear IC.
- 2) Design the world's greatest application for it.
- 3) Send the application to us.

All entries will be judged by the editors of EEE Magazine. Every

month, they will select the most fantastic application and give us the designer's name. We'll publish the winning design here and give the winner \$100 upon publication.

To give you an idea of what we're looking for, here's Richard Burkhart's design:

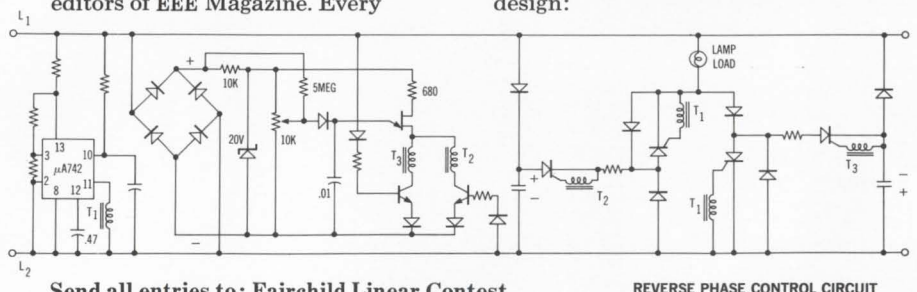

Send all entries to: Fairchild Linear Contest  
P.O. Box 880A, Mountain View, California 94040



# New Op Amp has Gain of 3,000,000.

Fairchild's new  $\mu A725$  Instrumentation Operational Amplifier can do the same jobs that used to require expensive chopper-stabilized or complex discrete component amplifiers. The  $\mu A725$  is ideally suited for use in Low Level Signal Conditioners, Instrumentation Amplifiers, Precision Measuring Equipment, Process Control Systems and Data Acquisition Equipment.

**Electrical Performance/Features**  
 Low Input Noise Current . . . . . 0.6pA/ Hz  
 High Open Loop Gain . . . . . 3,000,000  
 Low Input Offset Current . . . . . 3nA  
 Low Input Offset

Voltage Drift . . . . . 0.5 $\mu$ V/ $^{\circ}$ C  
 High Common Mode Rejection . 120dB

One of the many applications for the  $\mu A725$  is in Linear photo-detection systems. Use of a PIN Photodiode with the  $\mu A725$  provides the user with a low noise linear detection system which operates from low voltage supplies and has none of the inherent disadvantages of photo-multiplier tubes (high voltage supplies, aging effects, large physical size, high power dissipation).

Reader Service Number 328

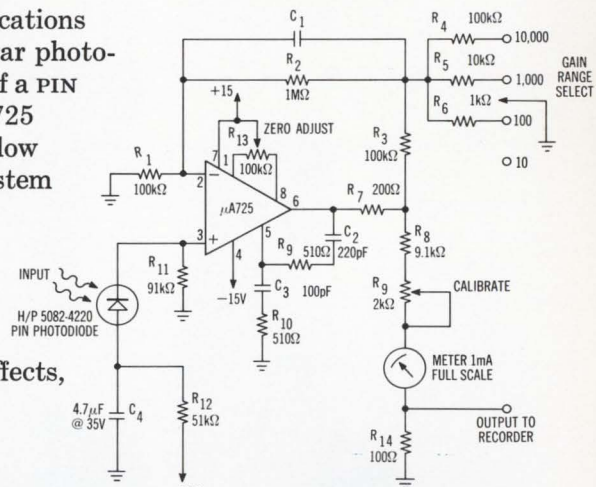

DC GAINS = 10,000, 1,000, 100, AND 10  
 BANDWIDTH = DETERMINED BY VALUE OF  $C_1$   
 GAIN ACCURACY  $\times$  1000 0.03%

$\mu A725$  PIN PHOTODIODE AMPLIFIER

# $\mu A715$ Basis of Fast Sample/Hold Circuit.

Many data acquisition systems require a sample and hold circuit to improve analog-to-digital conversion accuracy. The requirements of a good S/H circuit are:

1. minimum droop during the hold period
2. high open loop gain for good closed loop gain accuracy
3. high speed
4. minimum temperature drift

A basic sample and hold circuit configuration looks like this:

In the sample mode, the sampling switch  $Q_1$  is turned on and

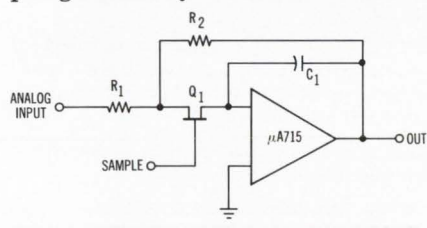

BASIC OPERATIONAL SAMPLE AND HOLD CIRCUIT

the circuit functions as an inverting operational amplifier.

When  $Q_1$  is switched off, the circuit functions as an integrator, holding the output voltage constant at the sampled value.

The acquisition time when going from the hold mode to the sample mode is a function of the time constant  $R_2C_1$  and the required accuracy, and is given by:

$$t_a = R_2C_1 \ln \left( \frac{100}{\% \text{ accuracy}} \right)$$

A complete sample and hold circuit is shown below. It includes the components necessary to compensate for the DC and AC errors inherent to the basic configuration. The DC offset is adjusted to zero by a 50k potentiometer ( $R_4$ ).  $C_3$ ,  $C_4$ , and  $C_5$  provide unity gain frequency compensation.

A junction field effect transistor is used as the sampling switch  $Q_1$ . Because there is some capacity from the gate to the source of  $Q_1$ , a portion of the gate signal to the switch is coupled through the device onto the holding capacitor  $C_1$  causing an offset error which is bucked out by an opposing signal, coupled by  $C_2$ , from the sample pulse input onto the holding capacitor.

**Holding Accuracy.** During the hold time the output voltage will tend to drift as the holding capacitor integrates the input bias current of the amplifier. This drift is compensated by supplying temperature compensated bias current from a separate source,  $R_5$ ,  $R_6$ ,  $R_7$  and  $D_1$ .

With a 10 volt step input ( $\pm 5$  volts to  $\mp 5$  volts) the settling time to  $\pm 0.05\%$  is 10 $\mu$ sec. This is slightly longer than that given by equation 1 due to the finite "on-resistance" of the sampling switch  $Q_1$ . If  $C_1$  is decreased to 100pF the settling time is about 1 $\mu$ sec. Temperature drift of the output in the hold mode is approximately 0.001% per degree Centigrade for a hold time of 100 $\mu$ sec.

Reader Service Number 329

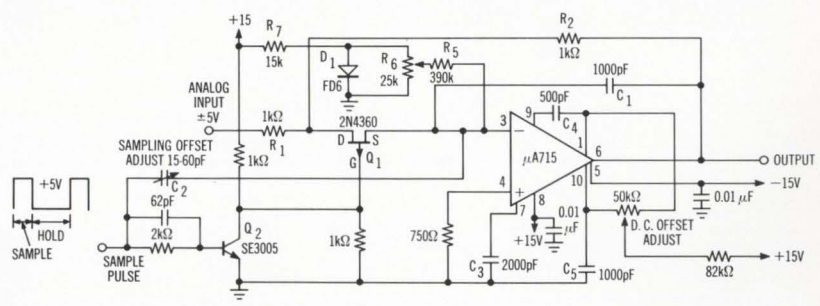

$\mu A715$  SAMPLE AND HOLD CIRCUIT





**Pat Paulsen takes time out from his expert advice on politics, philosophy, and physical fitness to say something important about connector manufacturing:**

“Some people say that Cinch has limited design capabilities just because they don’t announce a new connector every few weeks.

Picky, picky, picky!

What hamburger decided that a company noted for quality production innovations *doesn’t have capable design engineering?* Stop to think about it. You can’t have one without the other!

When Cinch designs a connector, they know they can build it—and deliver it.

Call Cinch when you need expert connector design assistance. They’ll produce a connector that will knock your eye out. What’s more, the price will surprise you.

You don’t like surprises?

Call anyway. You’ll be a better man for it.”

Cinch Manufacturing Company, 1501 Morse Avenue, Elk Grove Village, Illinois 60007, (312) 921-6151



CINCH MANUFACTURING, CINCH-GRAPHIK, CINCH-MONADNOCK, CINCH-NULINE AND PLAXIAL DIVISIONS OF UNITED-CARR INC., A SUBSIDIARY OF TRW INC.

C-6918



# Washington Newsletter

March 16, 1970

## Nixon approves 'Grand Tour' ...

Although the favorable Presidential decision on a 1977-79 "Grand Tour" of the outer planets won't affect NASA until the fiscal 1972 budget is developed, an initial forecast sets the cost between \$500 million and \$1 billion or more, depending on complexity. That's the estimate of NASA's Robert S. Kraemer, who's in charge of preliminary technology efforts in this area. About \$15 million has been spent each of the last two years at the Jet Propulsion Laboratory and the Goddard and Marshall Space Flight Centers. The Thermoelectric Outer Planet Spacecraft task force at JPL, which has been studying requirements for an outer-space mission like the Grand Tour, will continue to coordinate the centers' studies. But no single center will be selected to oversee the upcoming Grand Tour and no headquarters task group director will be named until 1972. That gives industry a year to push for prime contract management outside of the agency, although that prospect seems dim now as NASA tries to keep its own forces together. Meanwhile Paul Tarver, a program engineer in NASA's planetary programs office, will continue to oversee Grand Tour technology at headquarters.

President Nixon's move cheered space scientists, who have been pushing for a Presidential blessing on the Grand Tour—a probe which could not be duplicated for 180 years because the planets would not be favorably lined up. First launch is planned in 1977, for one or two spacecraft to swing by Jupiter and Saturn, reaching Pluto in 1986. A second launch in 1979, past Jupiter and Uranus, won't get to Neptune until 1988.

## ... but where will money come from?

There's still a gap between what the President approved for NASA and what it appears he's willing to pay for. Nixon suggests space spending will stabilize at about \$3.5 billion annually over the next few years. In view of NASA's commitment to ongoing programs close to that level already, there is no indication yet as to where Grand Tour money will come from—not to mention other space programs now moving toward higher spending levels. Some of these were indicated when the President expressed his preference for the middle ground of the second of three options recommended by his space task group last year [*Electronics*, Sept. 29, 1969, p. 48]. These programs include an unmanned Mars landing in 1976 after two orbital flights next year; unmanned orbital exploration of Jupiter in 1972 and Venus and Mercury in 1973 preceding the Grand Tour; a manned earth orbiting workshop, Project Skylab, in late 1972 or early 1973, plus the space shuttle which moves into design definition this year.

All of these plus Grand Tour should push space spending toward the \$5 billion mark by mid-decade, in apparent contradiction of the President's estimate, and outlays could go as high as \$7.3 billion by fiscal 1978. Nevertheless, Nixon urged further economies in the space program and called for increased practical applications of space technology.

## New budget cuts ahead for NASA?

Despite its smallest budget submission since 1962, NASA is facing unexpected difficulty in both Houses of Congress in its quest for quick approval of \$3.3 billion. Continuing criticism of emphasis on manned programs rather than unmanned applications satellites such as Earth Resources is heard from Rep. Joseph E. Karth (D., Minn.), chairman of



---

# Washington Newsletter

---

the subcommittee on space sciences and applications, and that has tended to overshadow significant disclosures of rising program costs elicited by Sen. Stephen M. Young (D., Ohio).

Young's questioning of NASA reveals that Viking Mars lander costs are pegged at \$750 million to \$900 million because of the slippage from 1973 to 1975. The estimate is up sharply from last fall's \$650 million figure. The Mariner Mars orbiter price tag is up from \$98.5 million to \$120-\$125 million. And Applications Technology Satellites F and G, which may slip as much as 12 months to 1973 and 1975, respectively, will cost an extra \$65 million.

Overall, Karth characterizes NASA's projected cost estimates as "asinine" and "unrealistically low." He says: "By virtue of these erroneous estimates, NASA must consider everyone outside the agency a stupid idiot. Worse yet, they may believe their estimates, and if they do we are in really bad shape."

## Kraemer to head planetary effort

Robert S. Kraemer will be named director of planetary programs for NASA (see related story on p. 131) replacing Donald P. Hearth, who was promoted to deputy director of the Goddard Space Flight Center. Kraemer now is an advanced programs and technology manager in NASA's Office of Space Science and Applications. His deputy, Donald G. Rea, has been advanced to the newly created post of assistant laboratory director for science at NASA's Jet Propulsion Laboratory.

## Foot-dragging cited in education, ocean study, procurement

A National Institute of Education to conduct research and experimentation is the only new idea in President Nixon's education-improvement program. And it offers little in the way of potential markets for electronics firms, says John Sodolski, vice president of the Electronic Industries Association's Industrial Electronics division. Sodolski, whose division had an education section that died due to lack of a market, says he is "kind of discouraged" about the field.

An "insidious" White House "conspiracy" exists to block legislation creating a national oceanic and atmospheric agency, says Sen. Ernest Hollings (D., S.C.), chairman of a Senate subcommittee on oceanography.

Instead of a new agency to act as a tent over the many programs in oceanic research, the Administration wants an assistant secretary for oceanography and meteorology in the Interior Department.

A third program suffering White House delay is the 12-man government procurement commission, to which Nixon has named only four members. Backers of the commission—among them many government contractors—fear that the President is stalling the study's start until he gets recommendations in July from Defense Secretary Melvin Laird's blue ribbon defense panel [*Electronics*, Dec. 22, 1969, p. 14].

## Sneak tests urged for emergency net

Communications equipment makers see the need for more backup capability if the FCC requires that tests of the nation's emergency broadcast system be switched to a random, unplanned format. That's what FCC's defense commissioner Robert Wells wants; he's against giving test participants prior notice. To achieve the capability of putting the President on the air in a matter of minutes without warning in a time of national emergency, Wells wants private industry not only to tell the FCC how to do it "but also to implement any plans conceived."



# In a world that offers a million different connectors, who needs 7 more?

We don't want to complicate your life.

We want to make it easier for you.

And we think these 7 printed circuit connectors are just the ones that can do it.

Each one started as a special order for a customer like Univac, Automatic Electric, or Mohawk. Each had so many possibilities that we got permission to make them for everybody.

So here's the biggest little line of connectors in the business. Utterly unique, not available as standard items anywhere else.

216-pin, 8-position

196-pin, 2-position

44-pin, 1-position

27-pin, 1-position

220-pin, 5-position

All connectors are made with our famous welded gold-dot contact design that puts gold only where it's needed, yet holds contact resistance below 5mV drop at 5A.

Until recently, you couldn't buy off-the-shelf connectors like these for love or money.

You still can't buy them for love. Sylvania Metals & Chemicals, Parts Division, Warren, Pennsylvania 16365.

98-pin, 1-position

40-pin, male-connecting module

**SYLVANIA**  
GENERAL TELEPHONE & ELECTRONICS



# Another new trio of VHF power transistors from United Aircraft

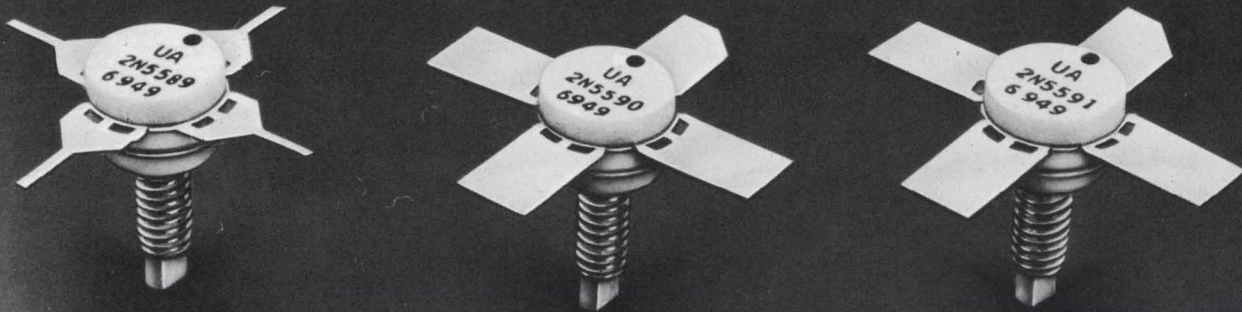

APPLICATION	DEVICE	FREQUENCY (MHz)	MODULATION	POWER OUT (WATTS)	POWER GAIN (MIN. dB)	EFFICIENCY MIN. (%)	T <sub>j</sub>	V <sub>cc</sub>	CASE
Class AB, B, & C VHF Amplifiers	2N5589	175	FM	3.0	8.2	50	200	13.6	TO-71
	2N5590	175	FM	10.0	5.2	50	200	13.6	TO-72
	2N5591	175	FM	25.0	4.4	50	200	13.6	TO-72
	2N5641	175	FM	7.0	8	60	200	28	TO-71
			AM	5.0 Typ.			13.6		
	2N5642	175	FM	20.0	8	60	200	28	TO-72
			AM	10.0 Typ.			13.6		
	2N5643	175	FM	40.0	7.5	60	200	28	TO-72
AM			20.0 Typ.			13.6			

- Large signal specifications
- Low inductance stripline packages
- Tantalum nitride emitter ballasting resistors

These latest members of the growing family of United Aircraft RF power transistors have been optimized for peak performance at 13.6 volts. Like the three models we introduced in November (see chart), these new devices—the 2N5589, 2N5590, and 2N5591—are designed for FM/VHF mobile communications equipment.

Also available: 2N4429, 2N4430 and 2N4431 RF power transistors in stripline and hermetic packages. **Our latest RF catalog** lists data on these and other devices in our line including: 2N3553, 2N3632, 2N3866, 2N5090, 2N3375, 2N3733, 2N4440, 2N5016, 2N4428, and 2N4012.

For RF power transistors for all VHF, UHF and microwave applications, write or call:

**Electronic Components** DIVISION OF **United Aircraft**

TREVOSE, PENNSYLVANIA Tel. 215-355-5000 TWX: 510-667-1717  
West Coast Office: 128 E. Katella Ave., Orange, Calif. (714) 639-4030

DESIGNERS AND PRODUCERS OF • RF AND MICROWAVE TRANSISTORS • CUSTOM HYBRID CIRCUITS • MONOLITHIC INTEGRATED CIRCUITS • SEMICONDUCTOR DICE





# It Won't Work!

There's a lot more to making modules than buying a few IC's and slapping them on a board. For one thing, the modules almost never work – the first time. Almost never the second time. Occasionally the third time. And that's only the prototype.

Chances are, Digital already has the optimum design, computer tested, fully debugged, manufactured, and sitting there on the shelf. Frustrating, isn't it?

Digital's M Series is the most complete, fully compatible, high speed, integrated circuit, inexpensive line of modules anywhere. We manufacture several million a year – many for our own computers – and know how.

Send for our new Logic Handbook. It tells you what, why, and how to build logic systems from modules. But, alas, not how to build the modules themselves.

DIGITAL EQUIPMENT CORPORATION, Maynard, Massachusetts 01754. Telephone: (617) 897-5111 / Cambridge, Mass. / New Haven / Washington, D.C. / Parsippany, Palisades Park, N.J. / Princeton, N.J. / Rochester, N.Y. / Long Island, N.Y. / Philadelphia / Pittsburgh / Cleveland / Dayton / Huntsville / Cocoa, Fla. / Chicago / Denver / Ann Arbor / Salt Lake City / Houston / Albuquerque / Los Angeles / Palo Alto / Seattle. INTERNATIONAL, Carleton Place and Toronto, Ont. / Montreal, Quebec / Edmonton, Alberta, Canada / Reading and Manchester, England / Paris, France / Munich and Cologne, Germany / Oslo, Norway / Stockholm, Sweden / Sydney and West Perth, Australia.

**digital**  
MODULES • COMPUTERS



# There isn't another like it. A 1/4-inch, single-pole, six position, 28-vdc. Helipot switch for PC boards.

**Beckman** INSTRUMENTS, INC.

**HELIPOT DIVISION**

Fullerton, California 92634

INTERNATIONAL SUBSIDIARIES: AMSTERDAM; CAPE TOWN;  
GENEVA; GLENROTHES, SCOTLAND; LONDON; MEXICO CITY;  
MUNICH; PARIS; STOCKHOLM; TOKYO; VIENNA

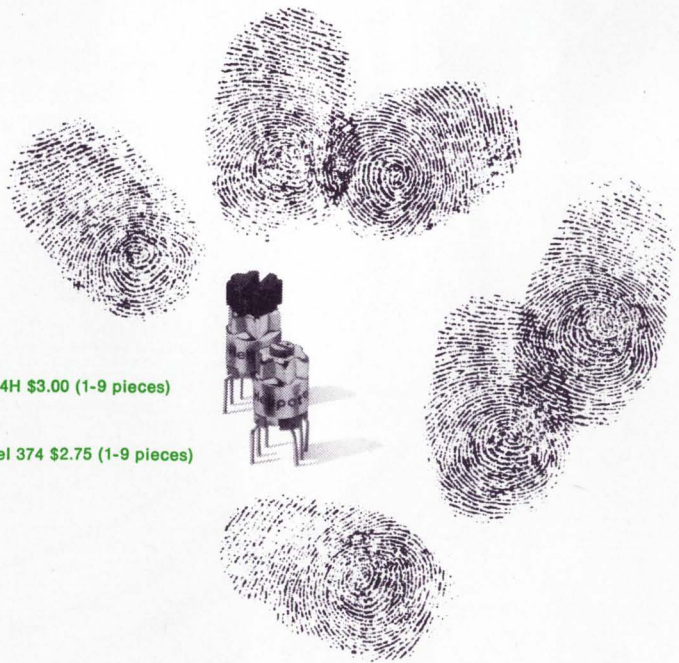

Model 374H \$3.00 (1-9 pieces)

Model 374 \$2.75 (1-9 pieces)



# Technical Articles

---

**Semiconductor lasers:  
'Disciplining' photons  
boosts efficiency  
page 78**

Long restricted by its low efficiency at room temperature, the GaAs laser may find a host of new applications through a new construction technique. Using a heterojunction next to the lasing cavity better confines light to the active regions, thereby greatly improving efficiency and drastically reducing power requirements.

**Portable laser system  
offers security for  
voice communications  
page 98**



As a communications device, the laser usually is used for its very large bandwidth capabilities. Now a system has been built that handles just a single, two-way voice channel. Using a low-power gallium arsenide diode and pulse-position modulation, it's compact enough to be carried on a helmet and a belt, and provides, secure, high-fidelity voice transmissions for such applications as ship-to-ship communications during refueling.

**New dot-matrix tube  
for brighter readout  
page 98**

The familiar stacked-cathode readout tube soon may be challenged by a new dot-matrix tube, which offers full alpha-numeric capability and sharper character resolution. The new design features recessed cathodes that eliminate the darkening effects of sputtering, thereby brightening readouts and increasing the display's life.

**4-wire performance  
from a 3-wire memory  
page 104**

Since a memory's sense and inhibit signals never occur together, it seems obvious that significant savings could be realized by combining both functions on one wire. But it's not quite that simple: new design problems crop up that must be analyzed and overcome before four-wire performance can be obtained from a three-wire, 3-D memory.

**A read-only memory  
to meet your needs  
page 112**

Inclusion of a read-only memory is a characteristic of third-generation computers and much of the peripheral equipment that goes with them. As such, they've proliferated rapidly, both in quantity and types. This article describes the principal types of read-only memories available now, and compares them with one another.

---

**TOPS for space tours**

## Coming

Lengthy, unmanned missions to the outer planets continue to occupy a prominent spot in NASA thinking; in fact, some could be launched by the end of the decade. Studies on TOPS (Thermoelectric Outer Planet Spacecraft) already are under way; these could heavily influence the missions.



# Semiconductor lasers: 'Disciplining' photons boosts the efficiency

New waveguiding structure enhances room temperature operation, says RCA's *Henry Kressel, Herbert Nelson and Harry Lockwood*; new uses are in the offing

● Many systems people who would like to go to optical devices to do their job find the scarcity of practical energy sources stands in their way. The gallium arsenide (GaAs) diode laser, smaller and simpler than gas and crystal lasers, requiring no pumping lamps and mirrors, should be a natural. But at room temperature, its low average power, low efficiency, and erratic behavior have made it unsuitable for most purposes.

A new laser-junction construction may change the entire picture. Called the "close confinement" structure, it incorporates a heterojunction—regions with different bandgap energies—to trap the light and the plasma in the narrow recombination region, thus reducing optical losses and increasing optical gain. As a result, room-temperature threshold current densities can be lowered by a factor of four or five, and lasing efficiency can be increased by a factor of two or three. These improvements lower the electrical power requirements for a given output and greatly improve power efficiency and life. Because of the improved laser operation, now possible are systems such as laser-voice communications, optical intrusion alarms, wavelength-matched pumping lamps for crystal lasers, and small portable range finders, altimeters and infrared illuminators. Further in the future are laser read-only memories with enormous ( $10^{10}$ ) bit capacities, and high frequency communication networks using c-w laser sources.

Yet only two years ago it was agreed that the GaAs laser, after an initial surge of interest, was useful only in a few specialized applications where refrigeration was acceptable, or at room temperature with a very low duty cycle. The reason was that at room temperature the diode laser was an exceedingly inefficient source of energy. Threshold current densities required for lasing were on the order of 60,000 amperes per square centimeter. And when made to lase, the power conversion efficiency—approximately 1%—and erratic life—up to a few hundred hours—discouraged users looking for low cost and stable energy sources.

Since it was suspected that the laser inefficiency was due to loss of light in the material surrounding the active lasing region, a method was needed to reduce these losses by improving the optical confinement. In the new laser close-confinement (CC) construction, this is accomplished by building a waveguide, of which one wall consists of an aluminum gallium arsenide-gallium arsenide heterojunction. The lower index of refraction of (AlGa)As at the GaAs lasing wavelength, compared to that of the GaAs in the active region, confines the light to the active region, thus reducing the optical losses in the surrounding nonlasing regions. The other wall of the waveguide consists of the p-n interface, in which a refractive index difference exists by virtue of differences in the doping level. Thus a greater fraction

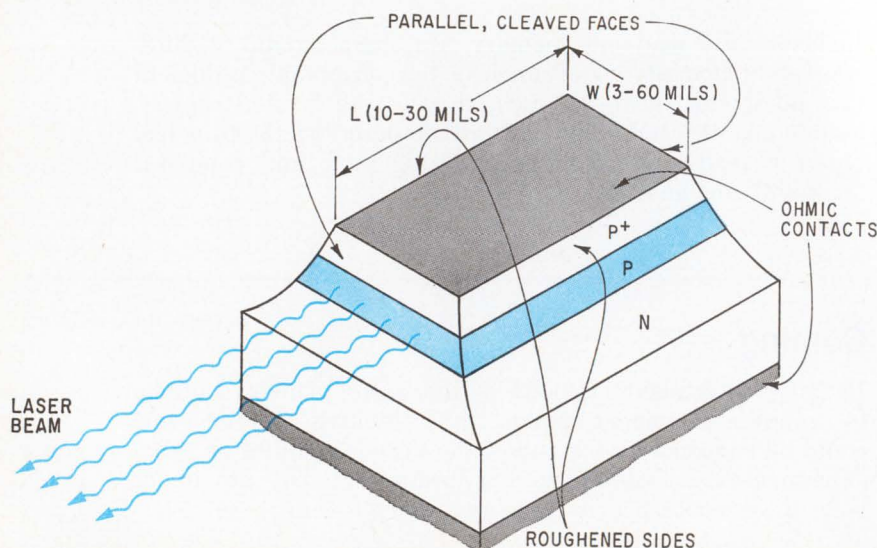

**Basic model.** Semiconductor diode lasers are made by cleaving two sides to form the reflectors of the Fabry-Perot cavity. The other two sides of the laser are sawed rough to prevent lasing in a crosswise direction.



of the emitted light is delivered to the output facet of the device.

A further benefit of the new construction is that electrons ejected from the n-region to the active p-region cannot enter the (AlGa)As  $-p^+$  region because of the potential barrier. Thus all the electrons injected contribute to the laser output.

As a result of the improved confinement, the CC device can begin to lase at room temperature at 8,000 amperes per square centimeter, a current density value at least three times lower than previously possible with conventional GaAs lasers. Also the external differential quantum efficiency—the measure of electron to photon conversion above threshold—can be as high as 50% at room temperature, a two to four times improvement over conventional GaAs lasers. Equally important, since heat losses in the CC laser are lower, substantially higher duty cycles are possible. In fact, depending on the quality of the heat sink, values up to about 20 khz have been obtained. Thus the average power possible from a single laser is substantially higher than before.

However, c-w operation at room temperature has not yet been achieved. Researchers, aiming toward room temperature c-w operation, are exploring the use of diamond heat sinks and narrow line geometry to obtain maximum heat transfer into the cool nonlasing regions.

The crucial factor in the new laser technology—

supported by the U.S. Army Electronics Command—is the ability to grow, with reproducible results, epitaxial layers of the mixed alloys of GaAs and AlAs from Ga solutions. This is done by the relatively simple epitaxial growth technique called liquid-phase epitaxy (LPE), which offers extremely close control over dopant levels. This control is vital to building reproducible heterojunctions, as well as making LPE growths on GaAs substrates adaptable to mass production. And the marked improvement in the quality of GaAs crystals, together with the availability of large defect-free substrates, could make possible mass-produced CC lasers.

Another benefit accrues from LPE growths of (AlGa)As lasers. Since the aluminum content can be controlled, and it determines the wavelength of the emission, it is now possible to make CC lasers with emission wavelengths ranging from the infrared into the visible. The shorter wavelength lasers are better suited for certain applications, such as high-speed film recording, because of the improved film sensitivity. Furthermore, by adjusting the laser wavelength, system designers can match the injection laser's emission to the absorption bands in neodymium doped glass lasers. Thus, the inefficient and short-lived filament lamps presently used to pump these lasers could be replaced.

The (AlGa)As laser can also improve the efficiency of laser illumination and communications systems. Since the sensitivity of optical detectors, such as the S-25 photocathode, improves with decreasing wavelength, greater detection sensitivity is available for a given source output, thus extending the range of the system. For example, optical rangefinders would be improved by replacing the 9,000 angstrom emission of the conventional GaAs laser with the 8,000-8200 Å emission obtainable from an (AlGa)As CC laser.

The CC laser obtains its improved performance through a modification of the conventional diode laser construction. In principle, the diode laser is simply a p-n junction device in which minute changes in the doping profile, thickness of the active region, or type of impurity used, make the difference between high efficiency operation and reasonable life or poor lasing properties and quick laser death. Its configuration consists of a cavity made by cleaving the GaAs crystal to form two parallel facets separated by from 10-30 mills. Called the Fabry-Perot cavity, it is the region

**Good guide.** Improved waveguiding in the close confinement structure is obtained by increasing the refractive index difference at the  $p^+-p$  interface. This is done by adding a heterojunction next to the active p-n junction which increases the bandgap energy of the  $p^+$  region. This increases the refractive index difference at the  $p^+-p$  interface which in turn helps to confine the light to the narrow active region of width  $d$ .

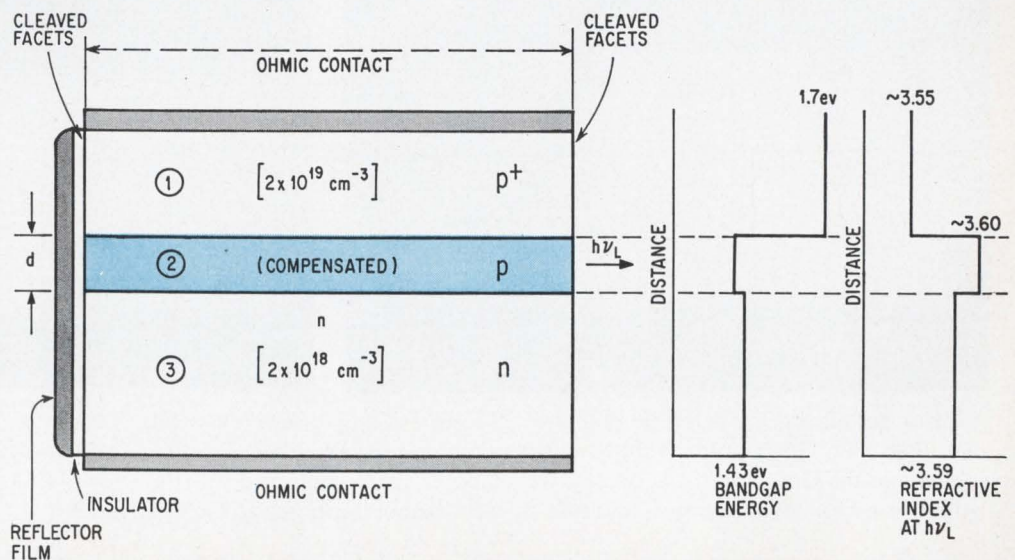



## Developmental key

Liquid-phase epitaxy (LPE) has been the key to the new developments in semiconductor lasers. But it is not restricted to just lasers. It also has played an important role in the significant advances in many devices in which III-V compounds are used, such as red and green light-emitting GaP diodes, silicon-compensated infrared GaAs, and (AlGa)As diodes. The LPE process differs from vapor-phase epitaxy in the methods used to grow semiconductor materials.

In LPE, laser growth, gallium is used as a solvent for the materials. A melt, consisting of Ga, GaAs, and Zn, is employed for the growth of a p-type epitaxial GaAs layer on the n-type GaAs substrate. This substrate is of the (1-0-0) orientation and is positioned at one end of a graphite boat, the melt being placed at the other end. The graphite boat is heated to an appropriate temperature in a pure hydrogen atmosphere in the quartz furnace tube. This furnace tube is tipped at an angle such that the melt and the substrate are kept apart as the graphite boat is brought to temperature. At a temperature of, say, 900°C, after the melt is nearly saturated with dissolved GaAs, the furnace tube is tipped to cause the melt to flow and contact the substrate surface. The furnace is then allowed to cool and epitaxial growth on the substrate occurs as GaAs precipitates from the melt. Depending upon the degree of saturation of the melt, more or less material is dissolved from the substrate immediately upon contact with the melt. Thus, epitaxial growth is

commonly initiated not on the original substrate surface but at a depth of about 15 microns below this surface.

By varying the semiconductor materials and their alloys, a great number of variations of this procedure can be employed in special applications. In fact, devices such as tunnel and avalanche diodes, Gunn effect devices, and a great variety of superior luminescent diodes and injection lasers were grown with excellent results.

The photomicrographs show examples of material generated by LPE. The left figure shows a cross section of material used in the cc GaAs laser diodes. The upper of the two closely spaced lines shows the deposited interface between a p-type (AlGa)As

layer grown onto an n-type GaAs substrate. The lower line delineates the p-n junction formed by the diffusion of zinc from the epitaxial p-type layer into the n-type substrate. The space between the two lines forms the laser cavity. The right photomicrograph is a cross section of material employed for the fabrication of cc (AlGa)As alloy lasers. The lower single line shows the interface between an n-type (AlGa)As layer grown onto an n-type GaAs substrate. The upper of the closely spaced lines delineates the interface between a p-type (AlGa)As layer grown onto the epitaxial n-type layer, and the lower of these lines represents a p-n junction in this layer due to zinc diffusion.

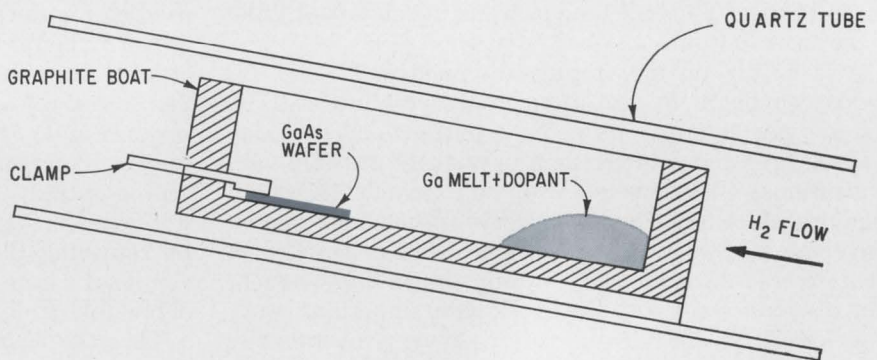

**Liquid phase.** To grow semiconductor diodes by LPE the furnace is tipped at about 900°C to allow the GaAs-saturated melt to flow over the substrate, the amount of material dissolved from the substrate depending upon the degree of saturation. With a suitable combination of solvents, dopants, and growth conditions it is possible to fabricate a variety of devices with this method.

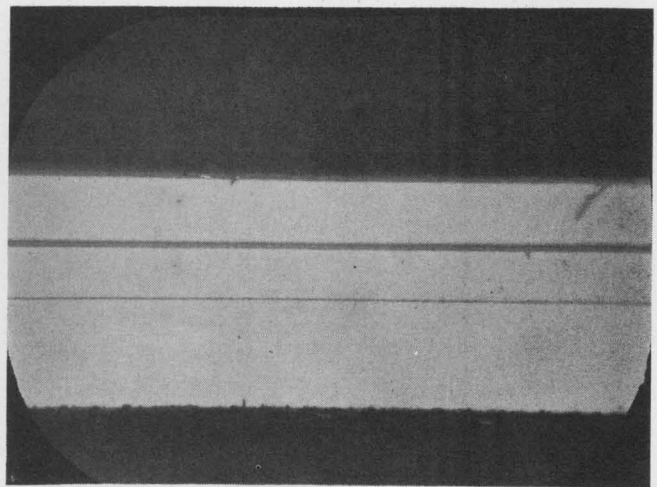
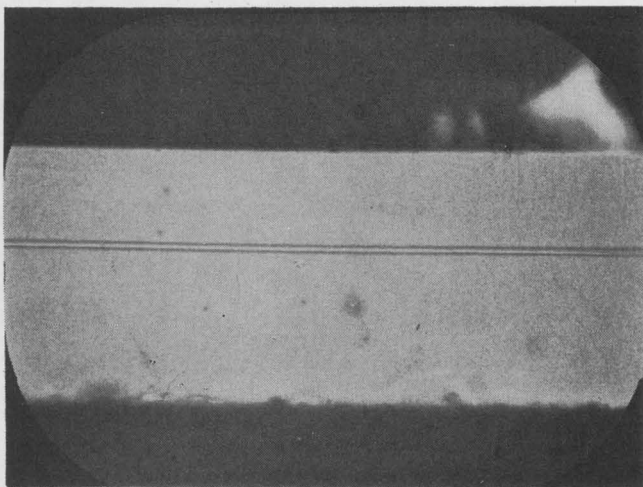

**Alloy or not alloy.** On the left, to obtain a CC laser emitting at approximately 9000 Å, an (AlGa)As, p<sup>+</sup> region is deposited on a GaAs n-type wafer. The active region between the parallel lines is formed by zinc diffusion from the p<sup>+</sup> region into the GaAs substrate. Shorter wavelengths can be obtained with the alloyed structure of the right. First an (AlGa)As n-type layer is grown, followed by a p<sup>+</sup> higher band gap (AlGa)As layer.



is a function of the doping level in the active region. Thus, the threshold current density can be expressed in a simple form, ( $b \cong 1$ )

$$J_{th} = \frac{1}{\beta} \left( \bar{\alpha} + \frac{1}{L} \ln \frac{1}{R} \right)$$

It is clear that for low  $J_{th}$  at a given cavity length  $L$ , the value of the gain coefficient,  $\beta$ , should be high and the average laser loss,  $\bar{\alpha}$ , should be low.

Total laser loss,  $\bar{\alpha}$ , is made up of three major contributions:

$$\bar{\alpha} = \alpha_{fc} + f_1\alpha_1 + f_2\alpha_2$$

The term  $\alpha_{fc}$ , which represents the absorption by free carriers (holes) in the active region, has a value at room temperature of about  $10\text{-}30 \text{ cm}^{-1}$ , depending upon the hole density. The term  $f_1\alpha_1$  represents optical loss due to light absorbed in the non-inverted p-type material. The absorption coefficient  $\alpha_1$  is high—about  $300\text{-}400 \text{ cm}^{-1}$  at room temperature. The value of  $f_1$  depends upon the degree of leakage of light into  $p^+$  region, the more the light is confined the lower the value of the term  $f_1\alpha_1$ . Finally, absorption of light in the n-type region is represented by the term  $f_2\alpha_2$ . Although the value of  $\alpha_2$  is only about  $10 \text{ cm}^{-1}$ , the better the confinement the lower is the value of  $f_2$ , and therefore the less the optical loss in the n-type region.

Because of the high  $\alpha$  in the non-inverted p-type material adjoining the active region, it is necessary to partially confine the light to the active region. Without confinement, impossibly high current densities would be required to reach threshold. Thus, an "optical waveguide" is needed, which can be achieved if there is a higher refractive index in the lasing region than in the surrounding non-inverted material, thus reflecting light back into the active region.

To obtain waveguiding it is necessary to adjust the doping so that the refractive index value at the lasing wavelength,  $h\nu_L$ , is higher in the active region than in the adjacent non-inverted regions. And one way of increasing the refractive index is to have a slightly smaller effective bandgap in the active region.

Some optical waveguiding does occur in a simple zinc diffused laser structure, but room temperature operation is inefficient. A more advanced design, the homojunction device made by liquid phase epitaxy (LPE), did improve the confinement by the addition of the  $p^+$  region within a few microns of the p-n junction.

In a homojunction structure the refractive index values are approximately 3.59 in the  $p^+$  and n-type regions, and approximately 3.60 in the active region, a difference of 0.01. While a substantial amount of optical confinement is obtained even with this small difference, there is still enough light leakage into the lossy  $p^+$  region to make the value of  $\bar{\alpha}$  equal to about  $100 \text{ cm}^{-1}$ .

It is desirable to increase both the index of refraction between the  $p^+$  and the p region and the absorption coefficient in the  $p^+$  region. This is done in the close-confinement structure where the  $p^+$  region has a higher bandgap energy than the active region. The bandgap energy difference is about 0.1-0.3 eV, resulting in a refractive index difference of 0.05, compared to 0.01 for the homojunction LPE laser. Now the calculated laser loss,  $\bar{\alpha}$ , at room temperature is reduced to between 15 and  $30 \text{ cm}^{-1}$  for typical doping levels, much lower than

where the electromagnetic waves are reflected back and forth, a large fraction of the energy being emitted at each pass. To ensure that the light is emitted from one facet only, a reflector consisting of a thin insulating film covered with a metal is frequently applied to one of the facets.

Laser operation results from the injection of electrons from the n-type side of the junction into the p-type side. In the region close to the p-n junction, the injected electron population is sufficiently high that a condition of "population inversion" exists, where the probability of photon emission is higher than that of absorption, a requisite for the formation of a laser beam.

Lasing occurs when the optical gain of the Fabry-Perot cavity exceeds the optical losses. The lasing threshold is reached when the optical gain,  $g$  (a function of the diode current  $J$ ) and loss,  $\bar{\alpha}$ , in a cavity of length,  $L$ , and reflectivity of the ends,  $R$ , satisfy the condition:

$$R \exp (g - \bar{\alpha})L = 1$$

or,

$$g = \bar{\alpha} + \frac{1}{L} \ln 1/R$$

where  $\beta$ , the gain coefficient, increases with decreasing temperature and decreasing active region width, and



## Applications

The improved cc laser source now enables system's people to consider their use in applications where diode lasers were either marginal or impractical. In communications, short range (a few kilometers) systems have been built using a GaAs light beam modulated at a frequency of a few khz. However, for links carrying multichannel information, nearly continuous operation will be required, which is not yet possible at room temperature. Space communications with refrigerated diodes is, however, of potential interest.

In ranging and altimetry applications, the use of injection lasers in portable rangefinder systems is attractive. Peak power requirements of several hundred watts at low duty cycle are well within the capability of present devices. Coupling a GaAs or (AlGa)As laser with a high sensitivity photomultiplier or silicon avalanche diode detector results in a rugged lightweight rangefinder ideal for civilian and military field use.

Illumination is another immediate application. Besides the obvious scheme of pulsed illumination and continuous detection for simple night vision, a "gated" detector triggered by the laser source is possible which reduces background noise levels. With gated sources, illumination systems which increase visibility through smoke and fire, are being field tested for use in forest fires. Relatively high peak and average power are required for this type of application. Thus, multidiode arrays with refrigeration to increase the allowable duty cycle are employed.

An important potential application

is to phase information detection using holograms. Here the coherence and line width of the laser are critical for resolution—at this time not as good as that obtained using a gas laser. To detect the infrared hologram-image read-out by the laser, the imaging tube can be a vidicon utilizing a silicon target rather than the conventional target designed for the detection of visible images.

The cc lasers can be used in reading holograms for Si information storage systems. Holographic systems are desirable because the holograms can be made scratch-resistant and are easily and inexpensively replicated. However, to make full use of this optical storage and display technique, the light source used to retrieve the information must meet requirements too stringent for incoherent light sources; hence, a laser must be used. But this laser must form a well-collimated, highly monochromatic beam, well suited to semiconductor p-n junction lasers which are not complicated by pumping and cooling systems and do not require complicated optics.

Using only a single lens and an cc (AlGa)As alloy laser, A. Firester and M. Heller at RCA Laboratories have reconstructed an image of moderate resolution from a phase hologram. The apparatus consists of the (AlGa)-As laser, a lens, an embossed-vinyl phase hologram, and a camera. Because the radiating facet of the laser is quite small, the light can be collimated into a beam by a simple lens with the laser at its focal point. To achieve a beam divergence smaller than several milliradians, the lens need only have a focal length of

a few inches. This collimated beam then impinges upon the phase hologram. The light diffracted by the hologram is imaged onto a photographic or television camera or a detector array.

A photographic image made with this system contains approximately 40,000 resolution elements; it has about the resolution of a typical tv picture. Indeed, with the same laser operating conditions, the holographic image could also be detected by a silicon vidicon and displayed on a tv monitor. The cc alloy laser operated at 8,300 Å with an average power in the collimated beam of 0.2 milliwatts. The wavelength 8,300 Å was chosen because it is easily detected by Polaroid infrared film. Similar information storage capacities have been demonstrated with increased photographic exposures using GaAs lasers radiating at 9,000 Å.

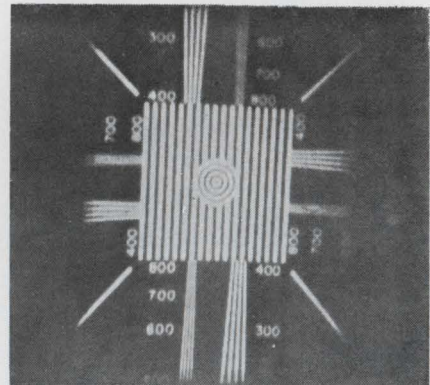

**Good grade.** The resolution of this laser-read hologram test pattern is about 40,000 elements, about the quality of a typical TV picture.

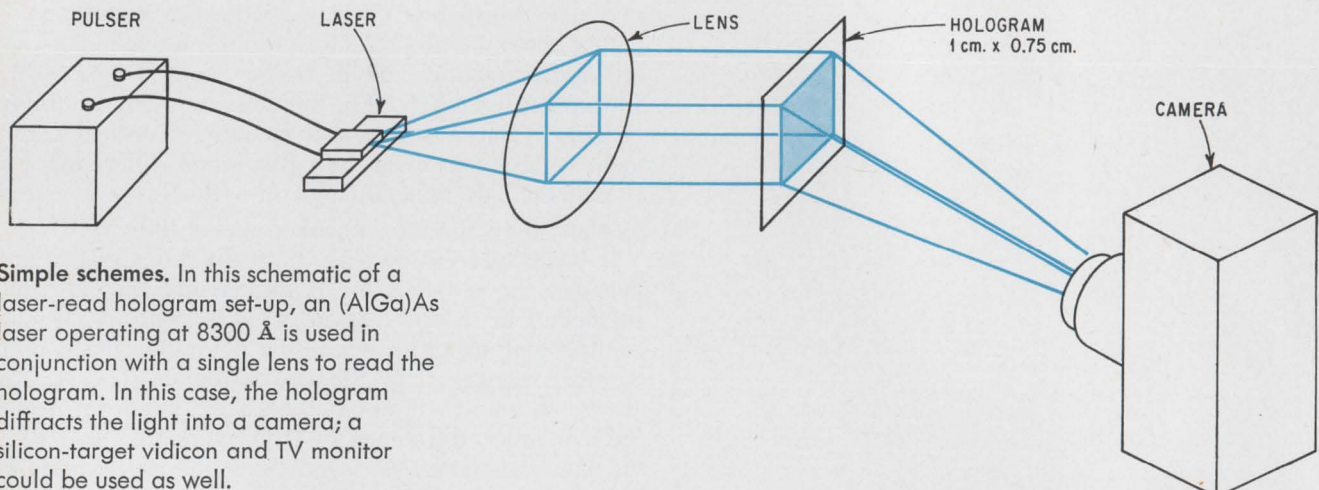

**Simple schemes.** In this schematic of a laser-read hologram set-up, an (AlGa)As laser operating at 8300 Å is used in conjunction with a single lens to read the hologram. In this case, the hologram diffracts the light into a camera; a silicon-target vidicon and TV monitor could be used as well.



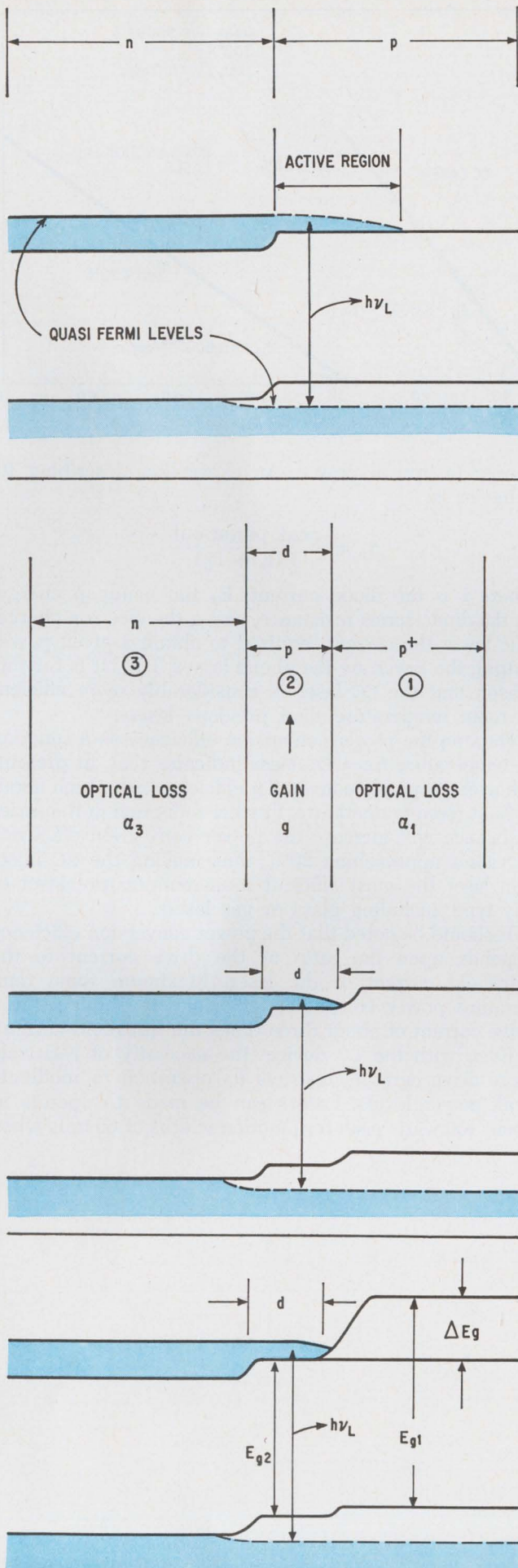

the value of  $\alpha = 100 \text{ cm}^{-1}$  in the homojunction laser. Not all wide bandgap compounds are suitable for the p<sup>+</sup> region. A compound must be chosen with a lattice constant as close to GaAs as possible, otherwise many dislocations are introduced at the interface which will ruin the laser. The (AlGa)As alloy is ideal because the bandgap energy varies from 1.43 eV to 2.13 eV, with a nearly constant lattice spacing. Ga(AsP) compounds, on the other hand, are not suitable because of lattice constant mismatching.

Aside from the decreased internal losses, the CC laser structure can also increase the gain coefficient,  $g$ —the second key laser quantity. High gain values at room temperature, achieved by using high doping levels in the active region, can be further increased by better electron confinement to a narrow active region.

In the simple diffused structure of the early GaAs lasers, the active region was not artificially controlled, so that it spread a distance comparable to the electron diffusion length. However, if a p<sup>+</sup>-p heterojunction is added next to the active region, the active region width,  $d$ , is made smaller than the electron diffusion length. The electrons must, therefore, overcome a potential barrier to escape the active region and diffuse into the p<sup>+</sup>-p region. Thus, the gain coefficient is higher than in the simple laser and contributes to a reduced threshold current density. Therefore, CC lasers, in addition to the lower optical losses, provide an additional bonus in higher gain for a given current density.

Performance data of the CC laser bears this out. With the CC laser, the same outputs can be obtained at room temperature with approximately one-third the diode current required for the conventional GaAs laser. For example, 8 watts of peak power is achieved with only 22 amperes as compared to 57 amps. This reduced operating current density contributes to longer laser life.

Aside from threshold parameters, the external quantum efficiency above threshold is substantially higher for the CC device than for conventional lasers. In fact, at room temperature, the quantum efficiency has increased from 20% for the conventional "best" laser to 50% for the "best" CC structure, with the difference narrowing as the temperature is lowered.

Equally impressive is the power conversion efficiency—a measure of how well the laser converts electrical

**Evolution.** With simple p-n junction diodes (top) no attempts are made to improve the electrical or optical confinement. The active region width is roughly equal to the electron diffusion length. In the conventional homojunction liquid-phase epitaxial laser (middle), there is a p<sup>+</sup> region adjoining the p-n junction. The active region width,  $d$ , is approximately equal to the separation between the p<sup>+</sup>-p and p-n interfaces. Some optical and electrical confinement results from this construction because of the p<sup>+</sup>-p barrier and abrupt discontinuity in doping levels. In the close-confinement structure (bottom) optical losses are minimized because of the increased refractive index different at the p<sup>+</sup>-p interface. Furthermore, the potential barrier at this interface is increased, thus making possible further improvements of electrical confinement for small  $d$ .



**Power to burn.** The CC laser has a threshold current density much lower than the typical homojunction laser. Its differential quantum efficiency is a factor of two or more higher than conventional lasers, yielding the same power output at a much lower drive current.

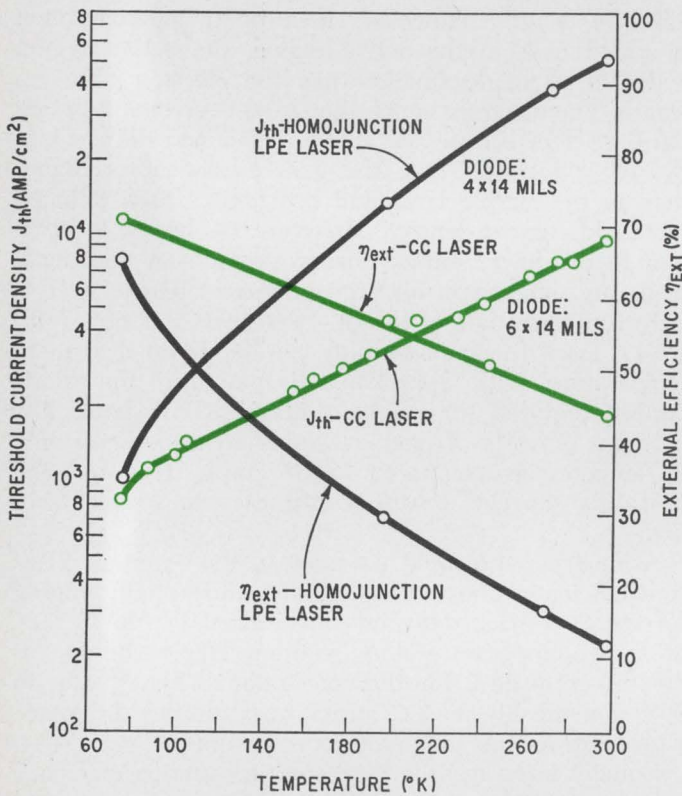
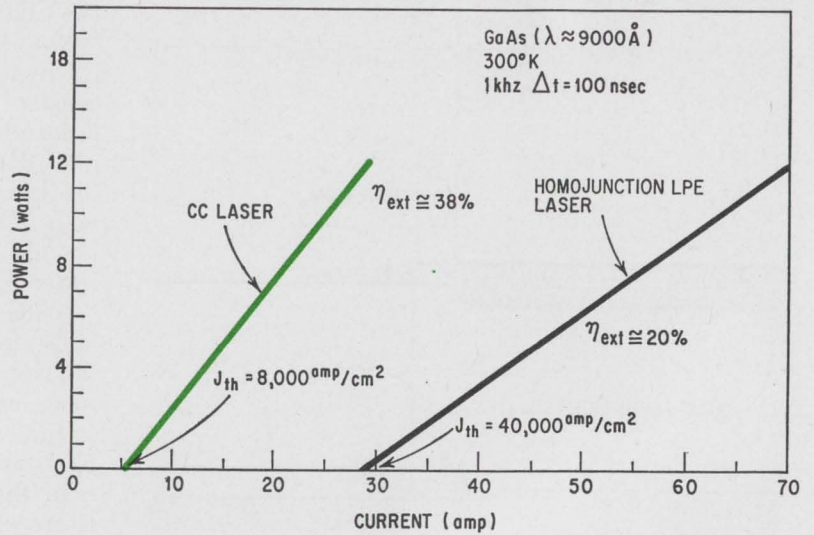

**Cool operation.** Although the CC laser has a threshold current density of about one fifth that of conventional lasers at 300°K, the difference is much smaller at lower temperature. And because of the CC laser's high room temperature differential quantum efficiency, further improvements with cooling are small. This is not the case with the conventional homojunction lasers.

energy to optical power. An expression describing its behavior is:

$$\eta_p = \frac{\text{peak power out}}{I^2 R_s + E_g I}$$

where  $I$  is the diode current,  $E_g$  the bandgap energy,  $R_s$  the diode series resistance, and  $q$  the electron charge. The lower the current required to obtain a given power output, the lower are the ohmic losses,  $I^2 R_s$ . It is for this reason that the CC laser is considerably more efficient at room temperature than previous lasers.

Data on the power conversion efficiency as a function of temperature for a CC laser indicates that, at present, the average power conversion efficiency can reach about 10% at room temperature. Further reduction in the series resistance will increase the power conversion efficiency to values approaching 20%, thus making the CC injection laser the most efficient room temperature laser of any type, including glass or gas lasers.

It should be noted that the power conversion efficiency depends upon the ratio of the drive current to the threshold current of the laser. Maximum room temperature power conversion efficiency is obtained at a drive current of about three times the threshold current.

Even with the CC device, the necessity of relatively large drive currents restricts its operation to moderate peak power levels. Lasers can be made to operate at about 100 watts peak for junction widths of 60 mils when



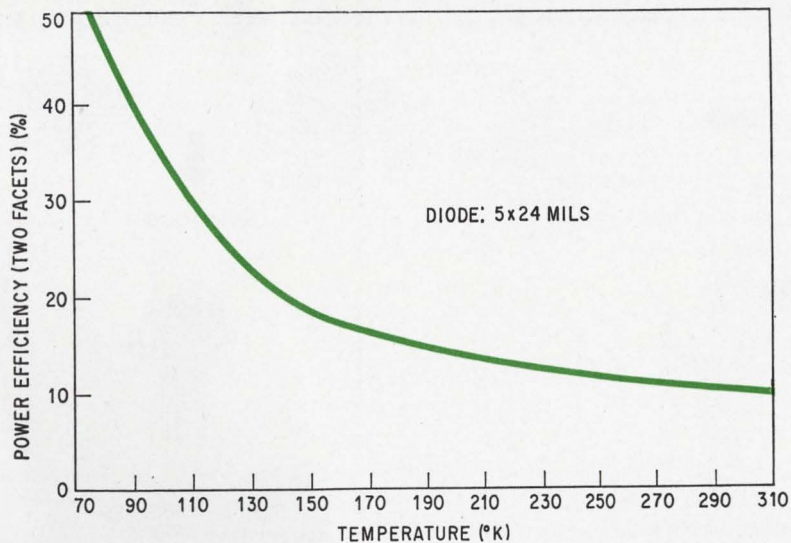

**Highly efficient.** The substantial decrease in the threshold current density means that the power conversion efficiency improves significantly. The reason is that the losses go as  $I^2R_s$  and as  $I$  is decreased by cooling, the power conversion efficiency goes up. At room temperature the conventional laser has a power conversion efficiency of 1-3%, compared to an efficiency of 5-10% for the CC lasers operating at the optimum drive current.

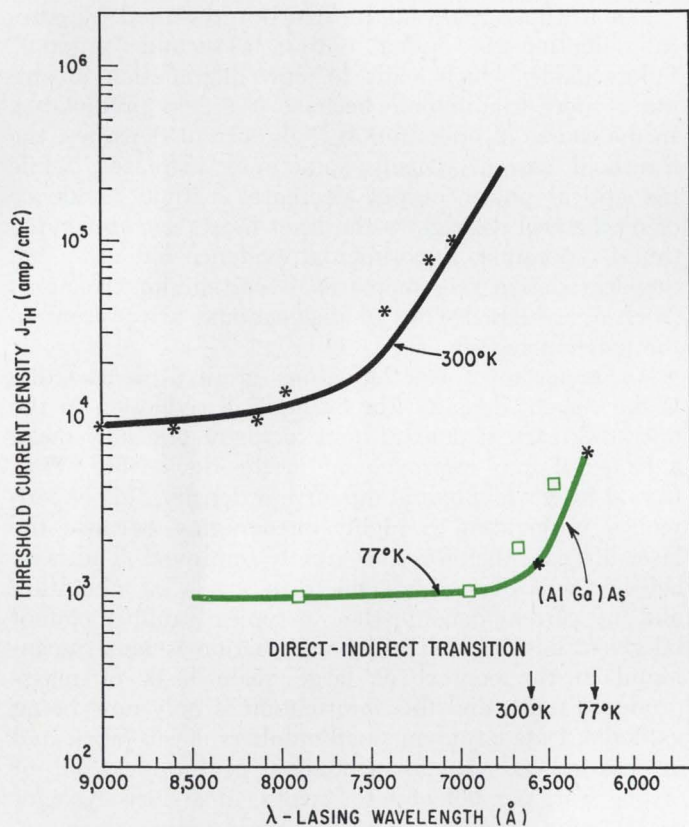

**Direct improvement.** The threshold current density increases sharply in the vicinity of the direct to indirect bandgap energy transition. For a given lasing wavelength at room temperature, the state-of-the-art CC (AlGa)As laser has a threshold current density nearly an order of magnitude lower than previous Ga(AsP) laser

operated with short pulses—about 25 nsec. However, such wide lasers are difficult to fabricate with present fabricating techniques.

Higher power levels in a single laser of this width cause catastrophic damage and sudden laser death. To obtain higher power outputs, lasers can be used in series combinations. Fabricated in stacks on a single substrate, this arrangement offers the possibility of obtaining kilowatts of peak power.

Besides offering better laser performance at room temperature, the CC laser, through the use of controlled alloy doping levels, can emit energy closer to the visible spectrum. Using (AlGa)As alloys, the CC laser can operate at room temperature in the near infrared through to the near visible portion of the spectrum. This flexibility will improve some injection laser systems that are now limited by the mismatch between their infrared wavelength (9,000Å) and that of their companion imaging detectors, whose performance improves as the wavelength shifts toward the visible range. In fact, from an overall systems point of view, emitters in the range of 8,000 to 8,200 Å are more desirable because of the higher sensitivity of the S-25 photocathodes when operating in this range.

CC alloy lasers have operated between 7,100 and 8,800 Å at room temperature, and down to 6,300 Å in liquid nitrogen. Data taken during CC laser operation shows that the laser threshold current can be made essentially constant between 9,000 and 8,000 Å. In essence, the CC laser can be tailor-designed to optimize the detector response without suffering a decrease in laser performance. This introduces valuable degrees of freedom for systems people; for example, by adjusting the output frequency of the light emitter to match the response of the detector, the system can operate at lower emitter powers or with the same power at increased ranges.

Reliability, another subject often misunderstood by users, has plagued numerous semiconductor devices in their early developmental stages. GaAs tunnel diodes are a case in point; their reliability problem was never solved and, therefore, limits their use. With lasers, many of the problems encountered in their use are due to the improper recognition of the factors responsible for failure. Users of diode lasers tended to greatly overestimate the optical power which can safely be obtained



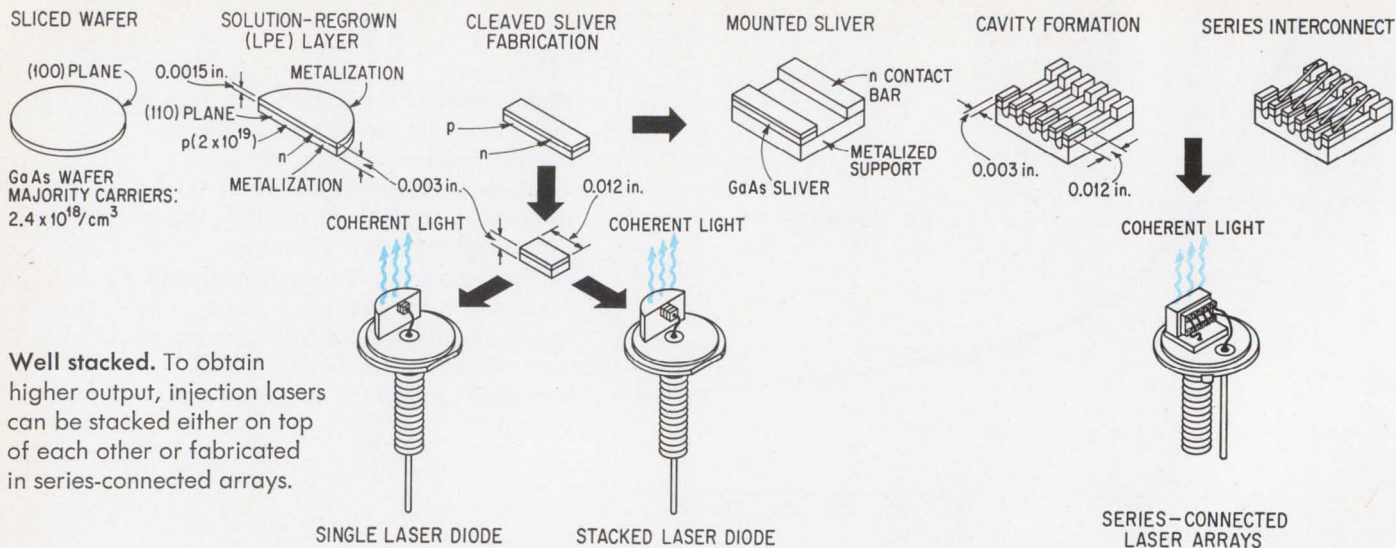

**Well stacked.** To obtain higher output, injection lasers can be stacked either on top of each other or fabricated in series-connected arrays.

from a chip of a given size, the result being rapid failure.

Two basic failure modes were recently isolated in research sponsored by the Avionics Laboratory of the Wright Patterson Air Force Base and the U.S. Army Electronics Command. The first, called "catastrophic", results from mechanical damage of the facets caused by excessive optical flux density in the active region and is independent of the current density in the device. The optical power which can be safely emitted, therefore, depends on such factors as the details of the laser fabrication, laser length, the temperature of operation, and the pulse width.

The close-confinement structure with its inherently higher optical flux density, does not overcome the problem of catastrophic failure as it is also subject to such failures. While the cause of the failure is still being studied, it is suspected that a fraction of the optical power in the laser is converted to acoustic energy—and ultimately to heat—at the laser facet. The conversion is apparently an outgrowth of the enormous optical flux densities in the narrow laser-waveguide region. With one watt/mil being emitted (400 watts/cm) in a waveguide region 2 microns wide, the optical flux density is  $2 \times 10^6$  watts/cm<sup>2</sup>. As a matter of reference, this is the flux density at which glass laser rods approach the failure level.

While catastrophic failure can be prevented by carefully limiting the optical output, a second "gradual" failure mode, which leads to slow degradation in output is more troublesome because it is less predictable. In the course of operation at high current densities, the threshold current density sometimes increases, while the optical power output decreases without evidence of mechanical damage to the laser facets accompanying this deterioration. Experimental evidence indicates that the degradation rate increases if certain imperfections (such as a high density of dislocations) are present in the junction region.

An important factor affecting gradual degradation is the current density. For example, a reduction in the operating current density by a factor of two may mean a factor of four improvement in the device life. With the CC laser's low operating current density, this experimental observation is highly encouraging because the laser life can, therefore, be greatly improved. The laser half-life will depend on the duty cycle of operation and the current density; thus, a typical number cannot be given. Besides, reliability information is most meaningful in the context of large scale tests of mass-produced units, and this information is only now being gathered. Data based on small numbers of lab-fabricated devices indicate that for a nominal peak optical output of one watt per mil of laser width, at a duty cycle of 0.04%—high enough for many applications—some experimental CC lasers have shown little degradation over a period of 2,000 hours of operation at a current density of 50,000 amps/cm<sup>2</sup>, with a laser half-life of 2,000 to 3,000 hours being a more average laboratory result. On the other hand, prior GaAs lasers, which must operate with current densities in excess of 100,000 amps/cm<sup>2</sup>, have typical half-lives of 200 hours, a life span that the CC laser's operation improves on by a factor of approximately 10. ●

### Bibliography

- J. C. Dymont and L. A. D'Asaro, *Applied Physics Letter*, Vol. 11, November 1967, p. 292.
- 1967 Semiconductor Laser Conference Proceedings, *Journal of Quantum Electronics*, Vol. 4, April 1968. Proceedings of the 1969 conference to be published in the June 1970 issue.
- H. Kressel and H. Nelson, *RCA Review*, Vol. 30, p. 106. March 1969.
- I. Hayashi, M. B. Panish, and P. Foy, *IEEE Journal of Quantum Electronics*, Vol. 5, April 1969, p. 211.
- H. Kressel and H. Nelson, *Applied Physics Letter*, Vol. 15, July 1969, p. 7.





**It's not just our  
MOS memory tester.  
It's our commitment to  
the MOS industry.**

**It's not the computers  
we build.  
It's the problems  
we solve.**

REDCOR has delivered, or has on order, more computer-controlled MOS test systems than all other manufacturers combined. In fact, nearly 80% of all MOS LSI/MSI devices produced in the upcoming years will be REDCOR-tested. Surprising, perhaps, but true. Why this vote of confidence from so many industrial giants? One reason is that we design and build, using state-of-the-art techniques, all the system components, including the computers. And we provide the systems engineering, the software, and the field service . . . a "one source, one responsibility" commitment. MOS testing may not be your application, but whatever your systems requirement, let a REDCOR Systems Pro solve it for you.

**R** REDCOR CORPORATION  
**C** Telephone: (213) 348-5892

See our MOS testers in action at IEEE — Booth 2H 13



# Designer's casebook

*Designer's casebook is a regular feature in Electronics. Readers are invited to submit novel circuit ideas and unusual solutions to design problems. Descriptions should be clear. We'll pay \$50 for each item published.*

## Zener in bootstrap extends amplifier's range to d-c

By Roland J. Turner

General Atronics, Philadelphia, Pa.

The input impedance of a conventional Darlington amplifier, limited to 2 megohms by the collector-to-base shunt loading of the input transistor, can be increased through a bootstrap arrangement. By placing a zener diode in the feedback circuit between the output transistor's emitter and the input transistor's collector, the input impedance is boosted to 30 megohms while input capacity is reduced from 4.5 picofarads for a non-bootstrapped stage to 0.5 pf for this circuit. And whereas other bootstrap arrangements are effective only for a-c signals, the zener diode bootstrap assures operation down to d-c signals as well.

The circuit's good low-frequency response makes it especially useful as an isolation amplifier in applications such as medical sensors and hydrophone transducers.

The Darlington circuit consists of complementary transistors which enable the output voltage to track the input over temperature variations with negligible d-c offset. As the input signal changes by some amount,  $V$ , the output,  $E_o$ , changes by  $KV$  where  $K$  is gain of the amplifier, and the input transistor's collector changes by the same amount. Thus the input resistance  $r_{c1}$  is effectively increased by  $1/r_{c1}(1-K)$ , with  $K$  usually being close to 1. Since the feedback capacitor represents a high reactance at low frequencies, blocking d-c, the zener diode extends the amplifier's operating range to d-c.

With super beta transistors such as the MC1556 used for the input transistor, an input resistance exceeding 100 megohms can be attained readily. These super beta transistors have a low breakdown voltage in the range of 5 to 7 volts, but by using a 1N750A zener diode in the bootstrap connection, the maximum voltage that can develop across the terminals of  $Q_1$  always is less than 5 volts (the zener breakdown voltage) even when the input signal swings are in the 10- to 100-volt region. The upper limit of dynamic range is limited only by the supply voltage and the breakdown rating of transistor  $Q_2$ .

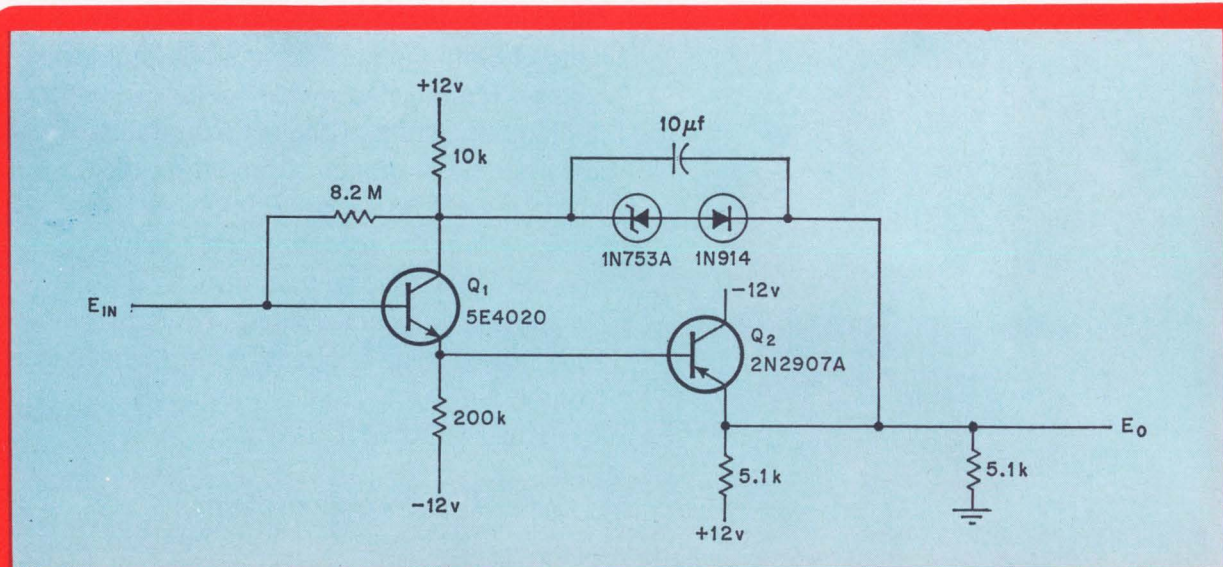

**Low frequency.** The zener diode bootstrap extends the operating range of the Darlington amplifier to d-c. Input capacity is reduced to 0.5 pf from the common 5 pf. With super beta transistors, input impedances in the 100-megohm range can be achieved, while the zener diode protects the transistors from breakdown.



# Two MOS FET's form transient-free linear gate

By John M. Firth

National Research Council of Canada, Ottawa

A linear gate will have better coupling characteristics if two, rather than one, metal oxide semiconductor field effect transistors are used. With two complementary MOS FET's in parallel, spikes that occur from the turn-on pulse being fed through the gate-drain capacitance are cancelled, and the input signal can be cleanly transferred to the input. The circuit is useful in multiplexing or sample-and-hold applications.

Transistors  $Q_1$  and  $Q_2$  form the complementary series linear gate. They are normally held off by a reverse bias applied to their gates. In addition, the substrates are reverse-biased via the 100-kilohm

resistors and are decoupled to ground. This helps minimize parasitic feedthrough.

A positive pulse is applied to transistor  $Q_7$ , turning it on; in turn,  $Q_6$  and  $Q_5$  are switched on.  $Q_5$  generates equal and opposite drive currents to turn on  $Q_3$  and  $Q_4$ , thus driving  $Q_1$  and  $Q_2$  at the same rates and assuring that transients generated by each MOS FET will cancel each other.

The capacitor  $C$  is a trimmer which can be adjusted to null any remaining transients that might occur from circuit asymmetry.

The gate's switching speed depends on the value of resistors  $R_1$  and  $R_2$ ; for higher speeds  $R_1$  and  $R_2$  should be decreased. The circuit is useful for sampling times down to 100 nanoseconds. The input voltage range is  $\pm 10$  volts and can be increased by increasing the supply voltages. The capacitor at the output is selected according to the holding time desired and the sampling time available.

The on-resistance of the linear gate is less than 200 ohms and the off-resistance is greater than 10 megohms.

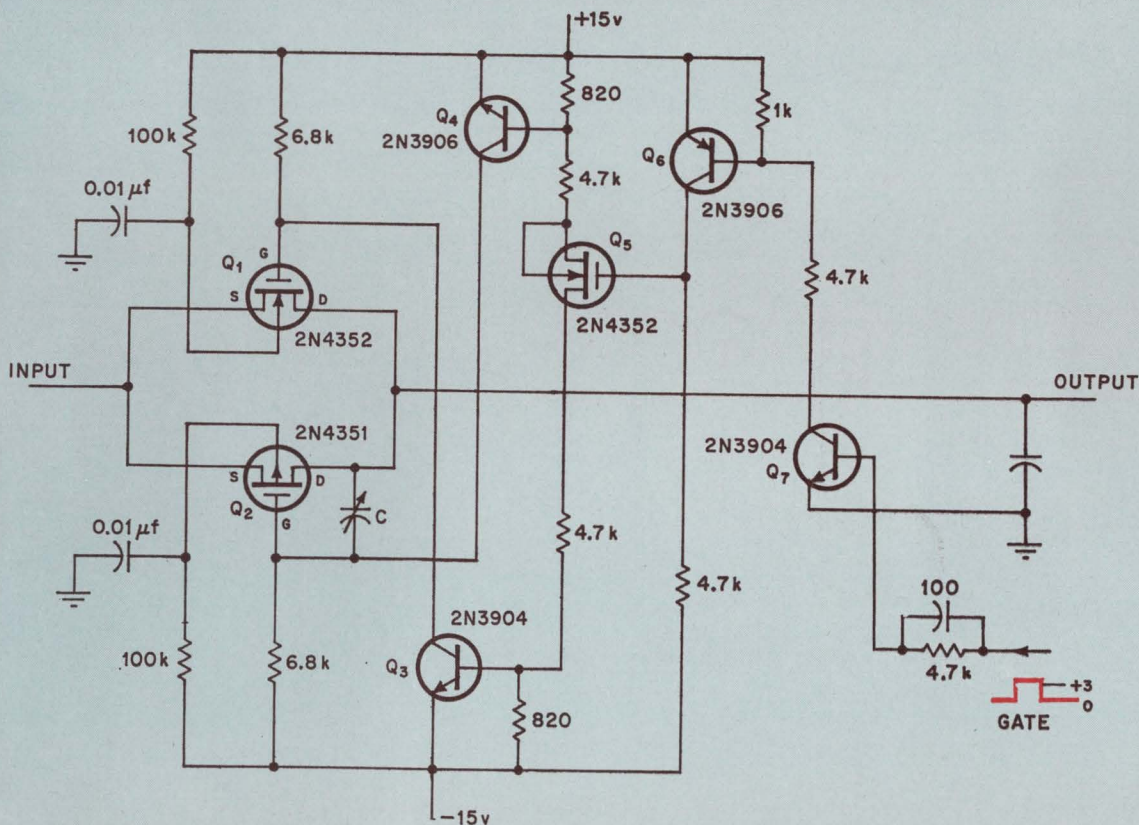

**Throughput.** The signal to be transmitted is fed to MOS FET's  $Q_1$  and  $Q_2$  simultaneously and transferred out when the two transistors are switched on. A positive pulse at  $Q_7$ 's input turns it on; in turn,  $Q_6$  and  $Q_5$  are switched on.  $Q_6$  turns on  $Q_4$  and  $Q_3$ , which, in turn, bias the two MOS FET's into conduction.



# DTL/TTL controls large signals in commutator

By Francis J. Honey

Denver Research Institute, Denver, Colo.

Two field effect transistors inserted at the virtual ground input of an operational amplifier allow high-voltage inputs to be switched by standard diode-transistor logic or transistor-transistor logic gates. Up to 10 pairs of FET switches can be connected together for commutating many input signals.

For the gating signal to switch the FET, the gate's voltage must exceed the sum of the applied signal voltage and the FET's pinchoff voltage. To accomplish this, two FET's are used. FET  $Q_2$  is inserted at the virtual ground of the op amp, assuring a minimum switched signal voltage when the FET is turned on. The second FET,  $Q_1$ , provides

the proper action in the off condition to insure that the input signal isn't transmitted during this interval.

When  $Q_2$  is gated on, the input signal is fed to the amplifier, but the virtual ground from  $Q_1$  makes the input signal very small and therefore allows  $Q_2$  to be held off by a gating signal only slightly larger than its pinchoff voltage. The maximum signal voltage that can be switched is limited only by the maximum signal swing of the op amp and its slew rate. Ten pairs of FET switches may be stacked to produce a 10-input commutator. The switches can be driven by DTL or TTL logic if the FET is chosen to have a pinchoff voltage less than 5 volts.

The maximum commutation rate is limited by the slew rate of the amplifier, 10 volts/second for the 4009. Thus signals can be switched at a rate of 100 kilohertz.

The RC low-pass filter has been inserted at the output of the amplifier to reduce switching transients that can arise from the gate-drain capacity of the FET's.

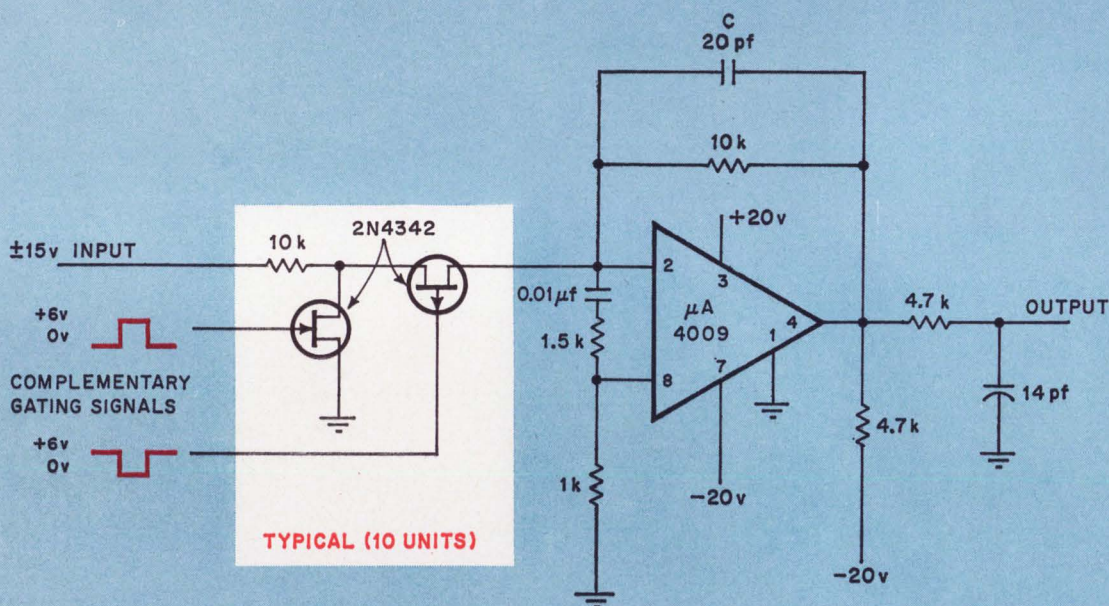

**Times ten.** Complementary inputs from either diode-transistor logic or transistor-transistor logic can be used to switch field effect transistors  $Q_1$  and  $Q_2$  on or off and allow high-input signals to be passed by the op amp. A stack of ten FET switches can be used to commutate input signals at up to 100-kilohertz rate.



# 50 MHz/2mV. No drift. No DC balance.

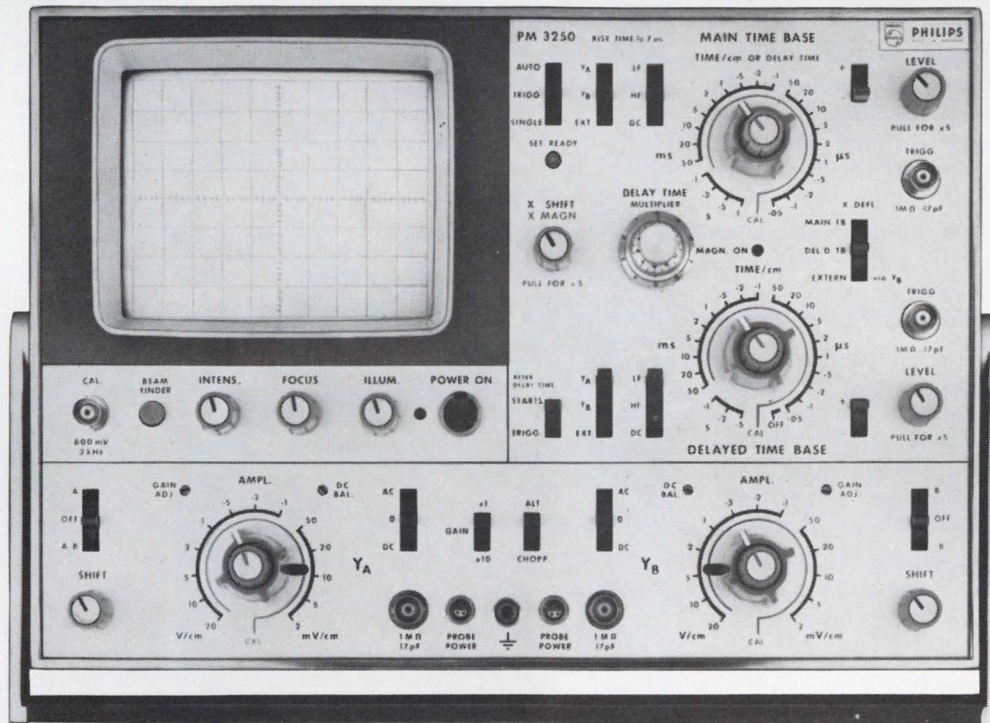

PM 3250  
50 MHz: 2mV  
Dual Trace  
\$1995

More of the Unbeatable  
Philips Scopes

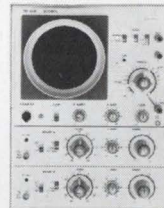

PM 3231  
15 MHz: 10mV  
Dual Beam  
Delay Lines  
\$975

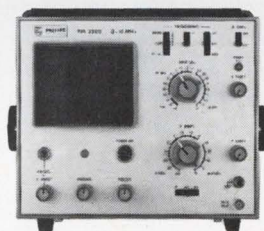

PM 3200  
10MHz  
2mV/div  
\$480

Where wide bandwidth and/or high sensitivity are required, PM 3250 fits the bill. 50 MHz at 2mV/cm or 5 MHz at 200 $\mu$  V/cm.

No drift—We've eliminated it by a solid state chopper compensation network.

No dc balance—We've eliminated that too. As well as a number of formerly significant knobs.

Unique? How about PM 3250's ability to display a differential signal (A-B) and the original signal simultaneously. Or, how about a simple rearrangement of the conventional switching circuit so that

the dc positioning range is 160 divisions for x10 sensitivity gain.

Versatile? Other features include a delay line in the vertical channel which lets you see leading edges properly with high speed sweep circuitry. Only 35 ns is lost from a total delay of 65 ns which minimizes signal distortion.

Also, there's a specially designed front panel which simplifies complex operation.

So, if your requirement is for a wide bandwidth/high sensitivity scope, fill it with our PM 3250.

**PHILIPS  
ELECTRONIC  
INSTRUMENTS**

750 S. FULTON AVE., MT. VERNON, N.Y. 10550  
A DIVISION OF PEPI, INC



# Portable optical communicator rides laser for secure voice transmissions

*Gabor Schlisser and Jules Inslar* of Holobeam Inc. have combined ppm and a low-power gallium arsenide diode in a high-fidelity, single-channel system that's sufficiently compact to be carried on a helmet and a belt

● Optical carrier communications usually take advantage of the very large bandwidth capabilities inherent in laser systems. However, narrow-bandwidth systems using only a single voice channel offer advantages too—high-fidelity audio transmission, freedom from interception due to the narrow laser beam, and portability and compactness. Holobeam has designed such a system for the Navy for use in ship-to-ship communications during refueling. But its portability—optics mounted on a helmet and electronics and power pack fitted to a belt—could be put to good use in the construction industry, where radio transmission could set off blasting charges and steel girders interfere with radio waves.

Since the room-temperature gallium arsenide laser diode cannot be operated c-w and its pulse width can vary as much as 10% due to temperature variations, the modulation technique had to be chosen carefully. Pulse-position modulation was selected over f-m, a-m, and pulse-width modulation for several reasons: f-m required higher-frequency diodes for sideband elimination to attain the same level of fidelity; lower power requirements for ppm at the laser's operating frequency; fewer atmospheric interference problems than most other forms of modulation; and inherently lower harmonic distortion—less than 2% out to 3 kilohertz—which could allow multiplex operation in the future. Pulse-code modulation was ruled out—it would require more complex and

**Hello, hello.** The laser and its optics are mounted in the upper portion of the helmet while the silicon photodiode is directly below. Photodiodes on each earpiece and one at the rear of the helmet insure omnidirectional reception.

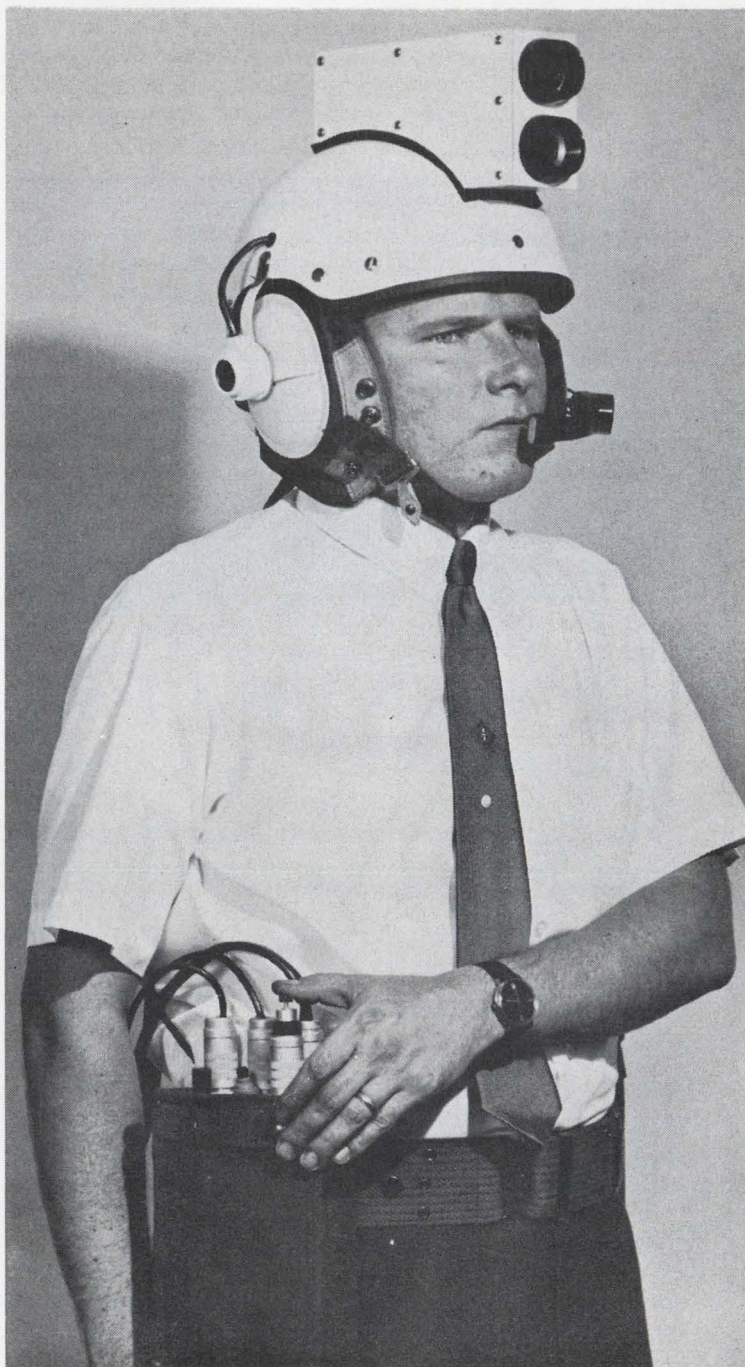



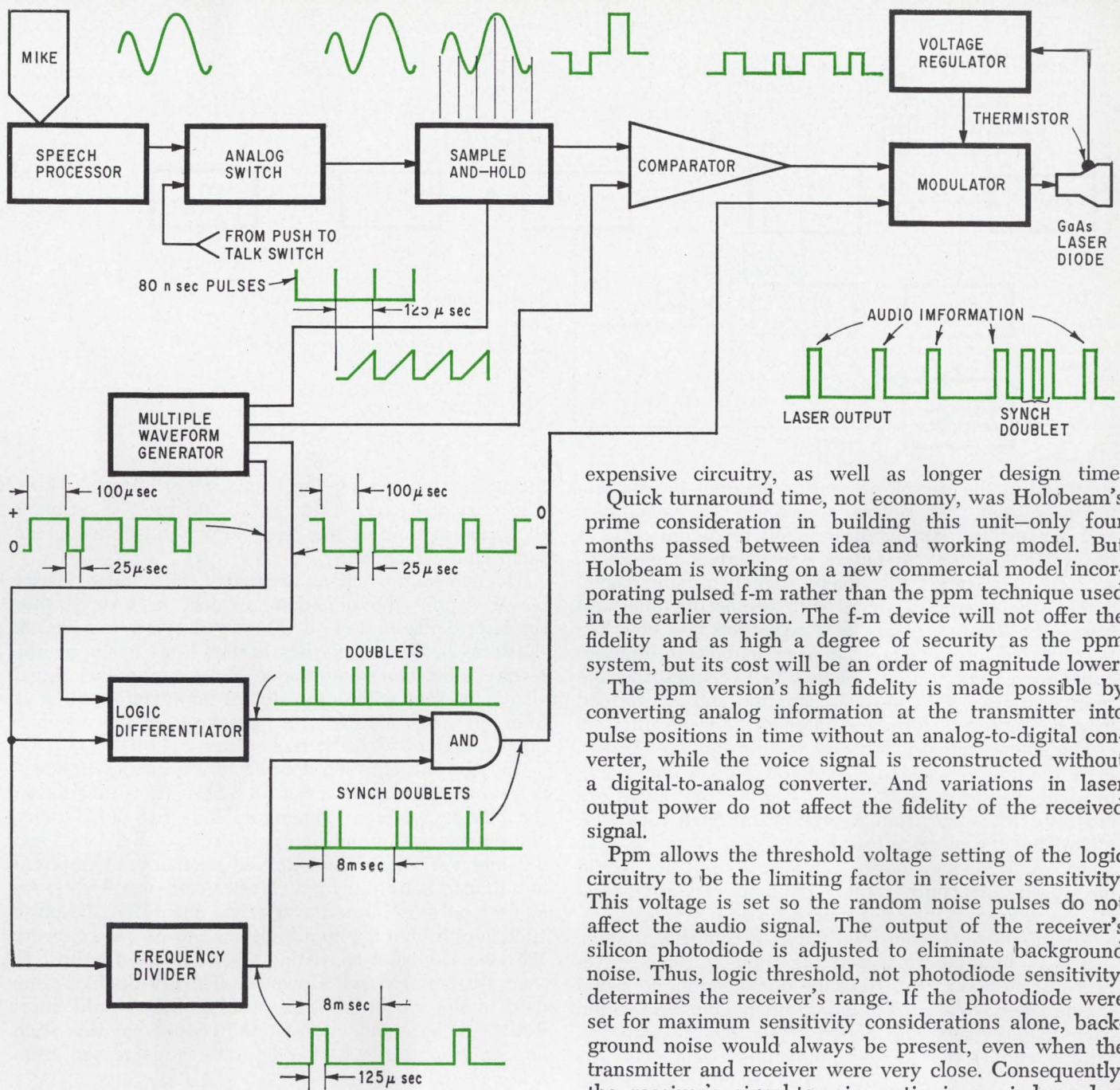

**Light the light.** Both the audio pulses out of the comparator and the synch doublets modulate the gallium arsenide laser diode on and off, corresponding to the input voice signal.

expensive circuitry, as well as longer design time.

Quick turnaround time, not economy, was Holobeam's prime consideration in building this unit—only four months passed between idea and working model. But Holobeam is working on a new commercial model incorporating pulsed f-m rather than the ppm technique used in the earlier version. The f-m device will not offer the fidelity and as high a degree of security as the ppm system, but its cost will be an order of magnitude lower.

The ppm version's high fidelity is made possible by converting analog information at the transmitter into pulse positions in time without an analog-to-digital converter, while the voice signal is reconstructed without a digital-to-analog converter. And variations in laser output power do not affect the fidelity of the received signal.

Ppm allows the threshold voltage setting of the logic circuitry to be the limiting factor in receiver sensitivity. This voltage is set so the random noise pulses do not affect the audio signal. The output of the receiver's silicon photodiode is adjusted to eliminate background noise. Thus, logic threshold, not photodiode sensitivity, determines the receiver's range. If the photodiode were set for maximum sensitivity considerations alone, background noise would always be present, even when the transmitter and receiver were very close. Consequently, the receiver's signal-to-noise ratio is an independent quantity.

The laser communicator was designed to have a maximum range of 10 miles with beam collimation set at 1 milliradian. However, to meet the Navy's specifications the beam was defocused to 300 milliradians, shortening the range to 250 feet while maintaining the 75-foot beam diameter at the 250-foot range.

Of primary concern was prevention of damage to the eyes of anyone viewing the laser beam. Thus, the output of the gallium arsenide laser transmitter was limited to a peak energy density level of  $0.7 \times 10^{-7}$  joules/cm<sup>2</sup>. The emitted light is in the infrared region—9,050 angstroms at room temperature—and is not visible. Its invisibility, as well as its directivity, contribute to the security already offered by the use of ppm.

Under the pulse-position modulation technique used in Holobeam's Naval device, the voice signal is converted into an analog electrical signal by a low-impedance microphone; the signal then is filtered and



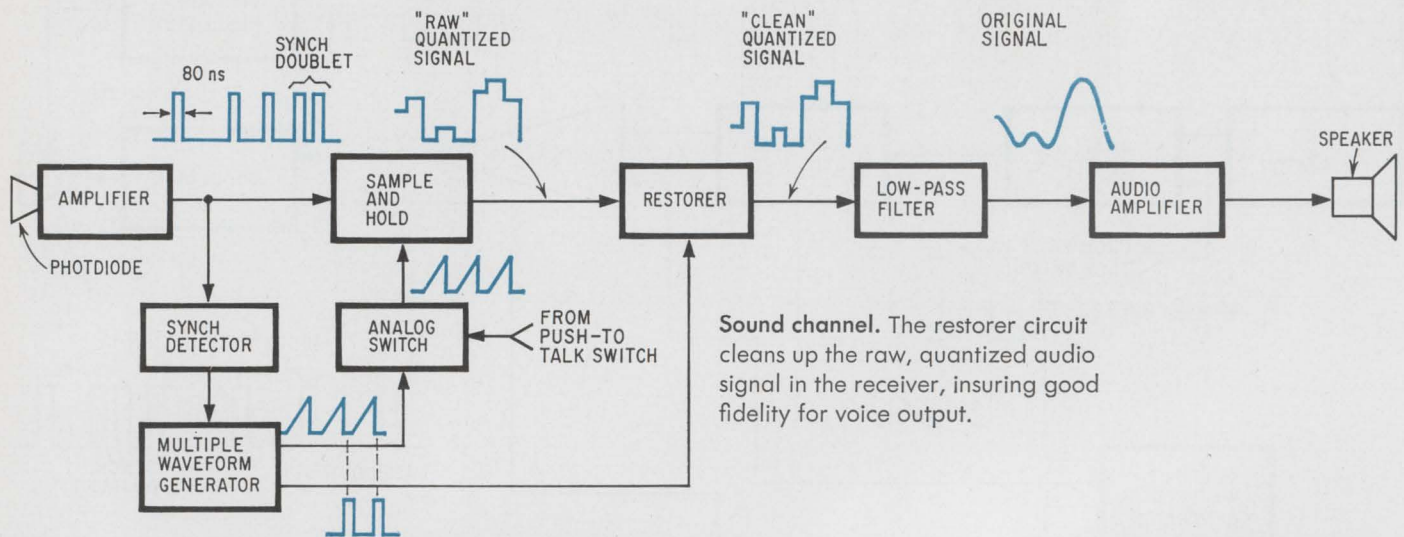

**Sound channel.** The restorer circuit cleans up the raw, quantized audio signal in the receiver, insuring good fidelity for voice output.

amplified in the speech-processing stage of the system.

The system uses several waveforms to synchronize and convert the analog information to digital data. A train of 80-nanosecond pulses, 125 microseconds apart, is used to quantize the analog signal; a ramp signal defines the quantized signal with respect to time; and a train of 100- $\mu$ sec pulses at a repetition rate of 8 kHz is converted into a train of 25- $\mu$ sec doublets, 8 milliseconds apart. They are employed in synchronizing the received pulses with those transmitted and are formed by a multiple waveform generator in the transmitter.

The analog signal is fed to a sample-and-hold circuit. Here the audio envelope is sampled and the conversion to a digital format is initiated. The 80-nsec pulses are fed into this stage from a crystal-controlled oscillator, quantizing the audio into voltage steps, each 125  $\mu$ sec apart. A frequency-locked stabilized oscillator could have been designed to replace the more expensive crystal-controlled unit had not time been so pressing.

The quantized signal then enters a comparator stage which is simultaneously fed the train of ramp waveforms at an 8-khz rate. Here the quantized audio signal is compared to the corresponding ramp amplitude within each 125- $\mu$ sec sampling period. Every time a ramp amplitude equals the corresponding quantized level, the comparator stage puts out a pulse, equal to the period from the time of equality to the end of the ramp. Hence,

the pulses put out by the comparator differ in width. The start of each of these pulses uniquely determines the point in time of the laser output pulses using the ramp as a reference.

The comparator pulses are fed to the regulated laser power supply—the modulator—which, in turn, flashes the laser diode on and off. These pulses are received in the form of 80-nsec flashes of the laser beam by the receiver's detector photodiodes. However, another signal also is present within the digital audio information—a train of synch doublets—to synchronize the receiver ramp generator with the transmitter.

The transmitter synch doublets are formed as follows: A train of 100- $\mu$ sec pulses at an 8-khz rate is inverted in the multiple waveform generator. Thus, two pulse trains, one positive-going and one negative, are fed to a logic differentiator stage. The logic differentiator is composed of a differentiator circuit, a rectifier, and an OR gate. An 80-nsec pulse is formed every time each 100- $\mu$ sec pulse train goes from a low to a high logic level. Hence, every 125  $\mu$ sec a doublet consisting of two 80-nsec pulses, 25  $\mu$ sec apart, is formed. However, if every doublet were used in the synchronization process, they would interfere with the audio information. To prevent this from happening, the synch doublet rate is decreased from 8 kHz to 125 hertz.

The output doublet rate of 125 hz is achieved by utilizing the positive-going 100- $\mu$ sec pulses used to form the doublets. The 100- $\mu$ sec pulses are passed through a frequency divider network whose output is a slow train of 125- $\mu$ sec pulses at a rate of 125 hz. Then the synch doublets and the 125-hz pulse train are applied to a two-input AND gate whose output is a train of doublets at a 125-hz rate.

Since the loss of synchronization is far more detrimental to good audio reception at the receiver than the loss of an audio pulse, special steps must be taken to insure that the doublets predominate when the two signals coincide. An exclusive OR circuit in the modulator switches out any audio pulses in the presence of a synch doublet. Because of its random nature, speech fidelity is not affected by the loss of a single audio pulse, so the modulator's output is a train of audio pulses interlaced with synchronizing doublets.

Since the laser is a current-switched device, the modulator must be a pulsed current supply. And the port-



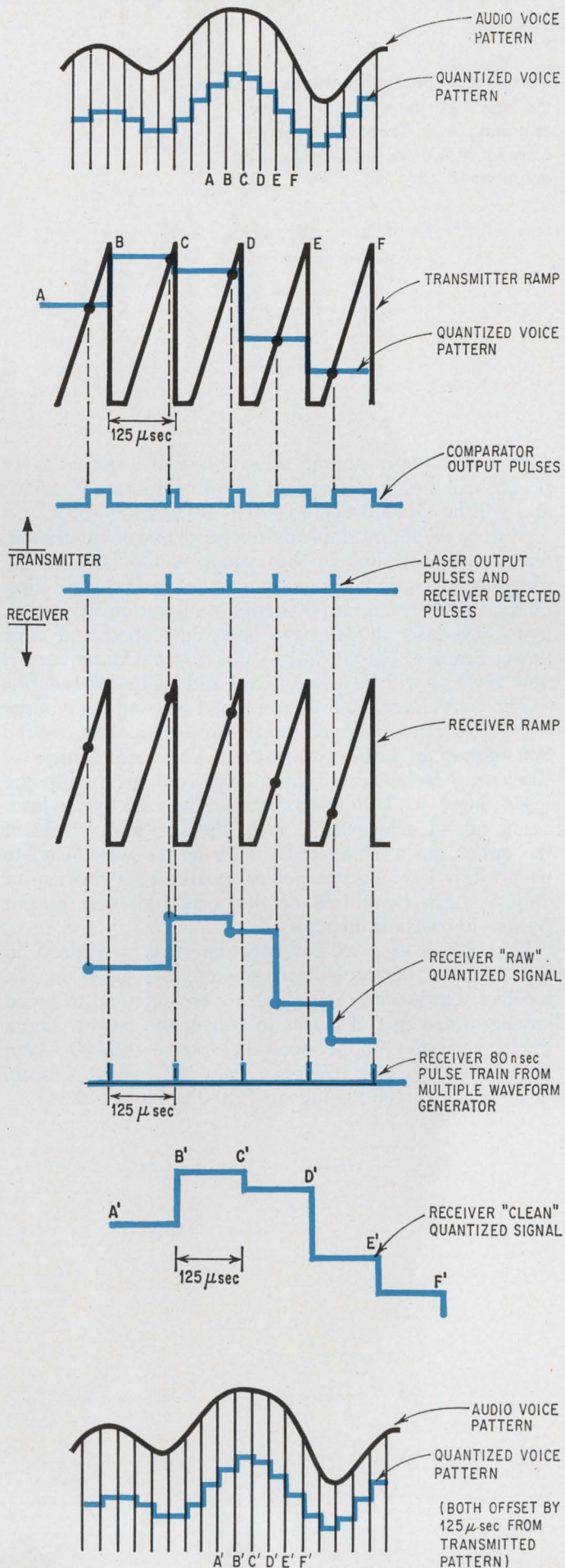

**Analog-digital-analog.** The analog voice signal becomes a quantized voice pattern at the sample-and-hold circuit. When the ramp voltage equals that of a voice step, the output of the comparator is a pulse whose width can be as large as 100  $\mu\text{sec}$ . The leading edge of each of these pulses triggers the laser pulse. At the receiver, the ramp amplitude and the detected pulses form a raw quantized signal of varying width. The 80-nsec pulse train combines with the signal in the restorer circuit, and cleans it. The result: the same audio signal as was transmitted, delayed 125  $\mu\text{sec}$ .

ability requirement of the system limits its maximum voltage. Thus, a current switch was designed using three high-speed transistors, thereby permitting a 40-volt power supply to charge the capacitor that provides the input current pulses—80-nsec duration and 40 amperes in amplitude—to the laser diode.

The receiver operates similarly, but in reverse. The photodiodes receive the train of voice pulses and synch doublets in the form of flashes of laser light. They are detected and amplified and sent to a sample-and-hold circuit and a synch detector circuit. The doublets are filtered out at the sample-and-hold circuit while the audio pulses are eliminated at the synch detector. The unwanted audio signals are removed by logic circuitry—a one-shot multivibrator and an AND gate—in the synch detector, while similar circuits are used in the sample-and-hold to remove the doublets.

The doublets act as a trigger for the receiver multiple waveform generator whose output is a ramp waveform and a train of 80-nsec pulses, both at an 8-kHz rate. The ramps are applied to the sample-and-hold circuit simultaneously with the audio information pulses; its output is a quantized audio waveform. However, the quantized signal is "raw"—the levels of the reconstructed signal are the same as the levels of the transmitted signal, but the duration of each level is random, rather than the 125- $\mu\text{sec}$  quantized levels used in the transmitter at the com-



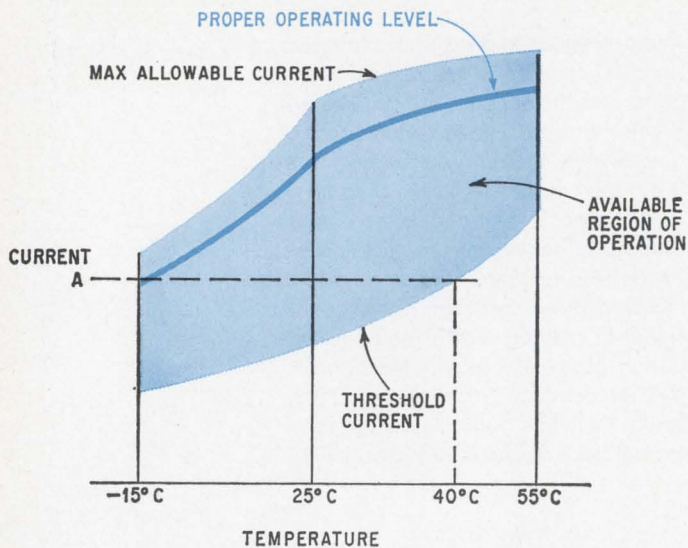

**Current monitor.** The thermistor maintains the laser input current at the proper operating level. Keeping the current constant at A amps produces zero light output at 40°C.

parator input. The 80-nsec pulses locate the start of each raw quantized step in the restorer stage.

A computer was used to design a circuit to restore the raw, quantized signal. A computer aided in designing the receiver; its analysis of the signal processing indicated that the quantized signal from the sample-and-hold circuit was not a faithful reproduction—the pulse widths were not equal—of the quantized audio signal generated in the transmitter. To restore the pulses to their proper widths, an additional sample-and-hold circuit, called a restorer, was employed. The synchronized 80-nsec pulses were used to sample the raw, quantized signal in a manner analogous to the transmitter encoding. The output of the restorer circuit is a clean, quantized signal with the desired 125- $\mu$ sec pulse duration. It's then filtered, amplified, and emerges as an audio signal from an external speaker.

This modulation technique is easily adaptable to multiplexing several voice channels without any significant design changes. It also allows the use of more complex coding techniques for additional transmission security.

The system expends just 5.5 watts transmitting and 3.0 watts receiving. However, this could be reduced to 1.5 and 0.2 watts, respectively, by better selection of components, switching off unused circuitry, and use of more efficient optics. Had more time been available, these lower power requirements could have been achieved, and the entire laser communications system could have been packed into the helmet alone. This type of system would use linear IC's in the analog circuits, rather than the discrete components presently used. In fact, Holobeam plans to build such a compact system.

Laser operation near its maximum output requires good thermal control—the laser diode will fail if the temperature falls more than 10° without laser current reduction. Therefore, Holobeam's design included a thermistor, a voltage regulator, and a pulsed current supply whose output is proportional to the regulator voltage.

The subminiature thermistor has a very small time constant, 2 seconds, and is mounted directly on the laser diode, which in turn is mounted on a 3-by-3-inch heat sink. The thermistor signal adjusts the output voltage of the voltage regulator to control the amount of current applied to the laser diode during each pulse. While the thermal control network maintains the laser input

current near its maximum allowable value, output laser power will be maximized at room temperature, 25°C, and will be down 3 decibels at -15°C and +55°C.

System reliability depends on good power regulation, but the weakest link in the system is the laser diode. The output power of the gallium arsenide diode will drop by a factor of two after 500 hours of operation. However, new GaAs laser diodes have been developed that offer power drops of only 25% in 1,000 hours. Consequently, new systems will be longer-lived and more dependable.

The GaAs laser diode is combined with a lens doublet—a system of two bonded lenses—to produce the desired 300-milliradian beam collimation. The focal length of the lens, 2 inches, was determined from the size of the laser source, while the lens diameter was set by the laser beam spread. However, to keep the size and weight of the optics down, smaller diameter lenses were used to collect less laser output power, resulting in the use of only 8 watts—two-thirds of the available laser output power—to transmit the signal.

Cost, however, was not considered as a tradeoff in the selection of the silicon photodiodes used in the receiver. Large-area photodiodes were selected to avoid having to use special lenses to collect the power. These diodes have an optimal spectral response at 9,000 Å and an effective area of 1.25 cm<sup>2</sup>; they can accept a beam at an angle of 100° using no focusing lenses. ●



Solitron's microelectronic amplifier.

## The little box with the big sound.

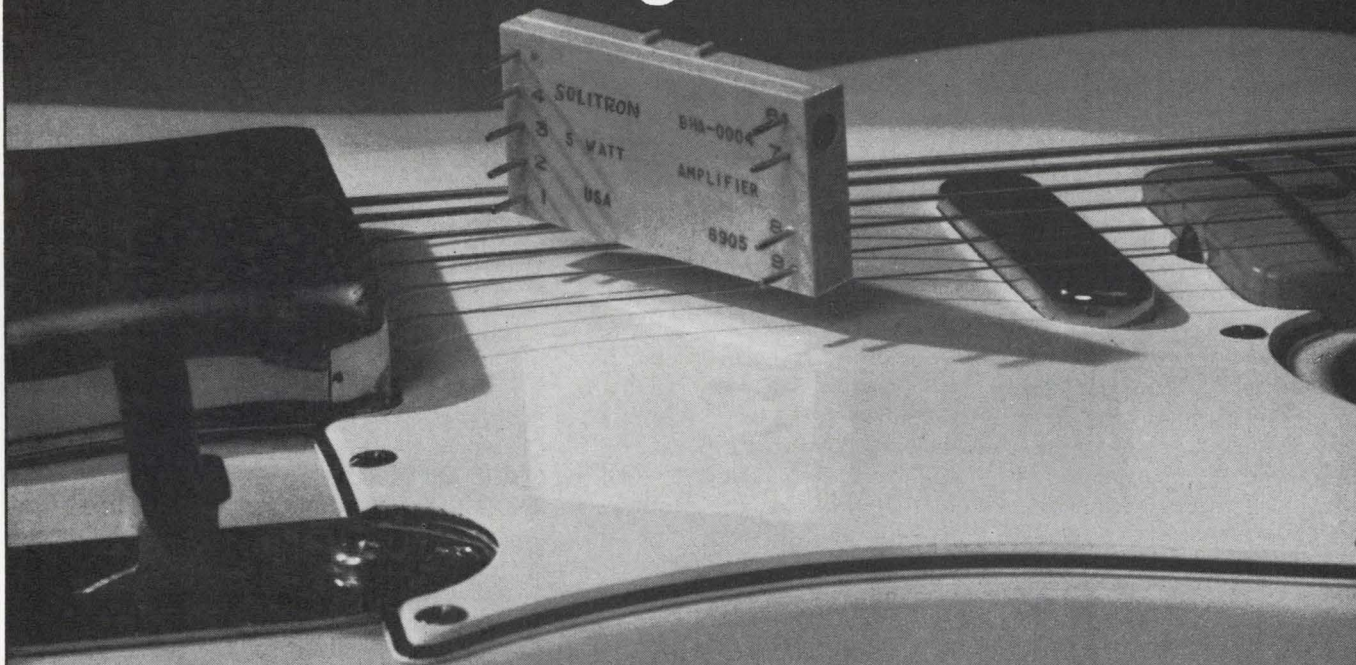

Recently, we introduced our microelectronic amplifier in consumer publications.

We called it the little box with the big sound.

It went over big. Thousands of guitarists and audiophiles began picking up on it.

Maybe you should, too.

Our little box with the big sound comes in two top quality packages of 5 or 15 watts.

Either one weighs less than  $\frac{1}{2}$  an ounce. And occupies less than  $\frac{1}{2}$  a cubic inch.

Yet both make a big sound.

For hi fi stereo, record players, tape decks, cassettes, PA systems, intercoms or whatever.

And it will save you and your customers a nice piece of change.

Reliable? Our little box is made via the latest thick film hybrid microcircuit construction: cermet chips on ceramic substrates.

For more information, write Solitron at 256 Oak Tree Road, Tappan, New York 10983.

Our solid state devices have been to the moon and back.

We might be able to give your sales a boost, too.



256 OAK TREE ROAD, TAPPAN, N. Y. 10983 / PHONE (914) 359-5050 / TWX: 710-576-2654 / TELEX: 13-7346



# Brighter digital readout with new dot-matrix tube

Recessed cathodes eliminate darkening effects of sputtering for brighter displays with longer life expectancy, say Mullard Research Lab's *G. F. Weston* and *R. F. Hall*

● The old stacked-cathode tubes, long the leader in electronic displays, soon may be overshadowed. Coming on strong are dot-matrix tubes. And now, thanks largely to an improved design for cathode placement and construction, a new gas-discharge 35-dot matrix display offers greater brightness, reliability, and operating life than the stacked-cathode and other matrix units.

Key to the new dot-matrix tube is the recessed cathode, which overcomes the problems of sputtering—material leaving the cathode and blackening the face of the tube. This could be especially severe for 35 cathodes located in a closely spaced array. But with recessed cathodes, the cathode pin is housed at the base of an insulating cavity whose walls collect the sputtered material, preventing it from reaching the glass face. With its improved operation, the dot-matrix tube can advantageously be used in electronic instruments, business machines, and industrial remote control where digital in-line readouts are required and high display speed is not essential.

The 35-dot matrix design developed by Mullard Research Laboratory is several times brighter than the stacked-cathode tubes, which are adequate for normal indoor applications but not bright enough to be read in direct sunlight or in a brightly lit room. More important, since the devices' cathodes are stacked one behind the other with insulating spacers in between, this results in

a cluttered appearance, with the numerals positioned in different planes. View angle is restricted—the cathodes at the back of the tube cannot be seen except from directly in front of the display. Worse yet is the "dancing" effect when the tube is counting, as the numbers flash from plane to plane. And the limited number of cathodes which can be stacked precludes an alphabetic readout.

The dot-matrix tube includes full alphanumeric capabilities in its 5 x 7 array. And because 35 dots can be used to form characters, definition far exceeds that of stacked-cathode tubes. Also, the dot-matrix device displays characters in one plane, allowing viewing angles of almost 90°, yet is small and flat, taking up a minimum of panel space.

Because a character is displayed by selecting the appropriate cathodes, the driving circuit in the dot matrix display is slightly more complex, requiring a pattern decoder to select the appropriate cathode out of the 35 possibilities. However, the decoder isn't complicated, and its cost can be offset by the expected lower price that an inherently simple matrix tube should attain.

In the dot-matrix tube, the effects of sputtering—common to every gas-discharge tube—had to be overcome. In conventional tubes, sputtering occurs when gas ions formed during discharge bombard the cathode and dislodge cathode material, which then diffuses through

**Bars and Dots.** Both bar and dot matrices are commonly used in matrix display devices. The bar matrix, which generally can display only numerals, has been used in electroluminescent and incandescent lamp devices. The 35 dot matrix array, in addition to offering greater character resolution, has full alphanumeric capabilities.

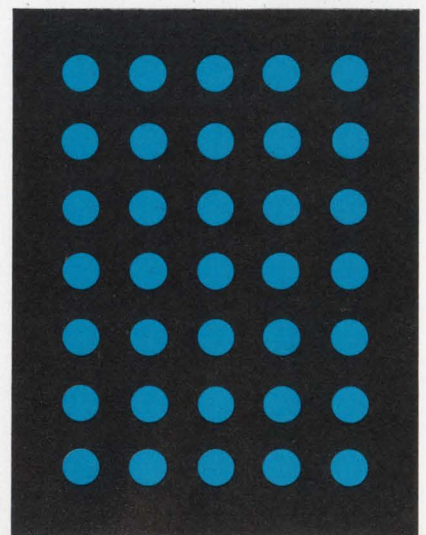
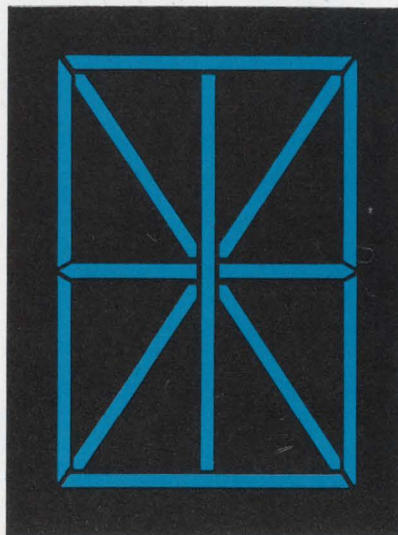



the gas. Conducting material is deposited on other parts of the tube. Sputtering decreases the light output by blackening the bulb, and in multicathode tubes material may be deposited on the insulation between the cathodes, causing electrical leakage and spreading of the discharge. Or it can build up on other cathodes when they are unlit, changing their voltage characteristics. Then tubes break down, resulting in display flicker and false readings. With 35 cathodes mounted in fairly close proximity, this breakdown problem could be particularly severe.

**The recessed cathode** construction solves the sputtering problem by placing the cathode pin below the surface of the surrounding glass to form the base of a cavity. It is in this cavity, whose walls are made of insulating material, that the negative glow of the discharge is contained.

This cavity arrangement eliminates the effects of sputtered material by drastically limiting its escape from the cavity, thus preventing its coating other parts of the tube. The sputtered material travels by diffusion in a zig-zag path through the cavity; this path results in a high statistical probability that the material will collide with the cavity wall and not emerge.

The walls of the cavity affect the tube operation in another way. As the sputtered film builds up on the cavity walls, the breakdown voltage tends to be lowered,

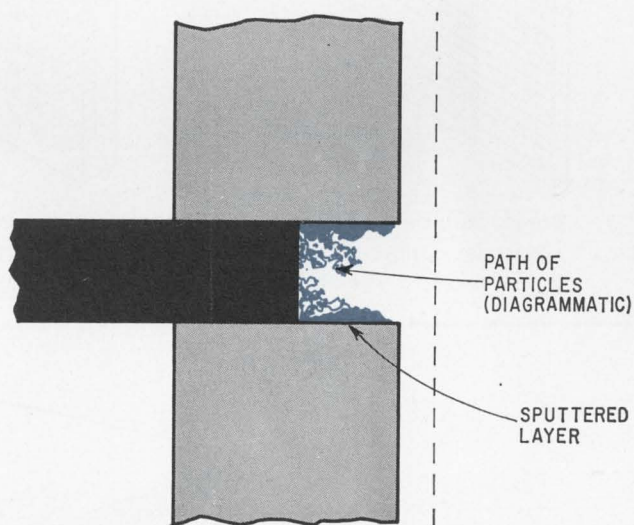
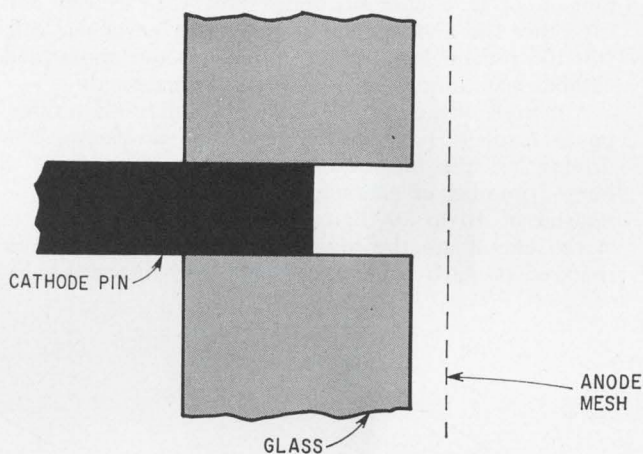

**Recess.** In the recessed cathode construction, a pin sealed into a glass foot is etched in place. During the glow discharge, the bombarding ions in the discharge eject cathode material (sputtering), which follow a random path in the gas. At sufficiently high gas atmospheres, these particles, trapped on the cavity walls, will be prevented from blackening the face of the tube.



## Guiding Light

To a large extent interest in the dot-matrix glow-discharge display was heightened by the recent work done on gas discharge display panels. These panels consist of a large, flat array of gas-discharge cells forming a dot matrix on which several rows of characters can be written, or on which graphical information can be displayed.

Usually the individual cells are formed by a two-dimensional matrix of small apertures in an insulating sheet placed between two electrode systems of parallel wires or strips mounted orthogonally in a crossbar arrangement. One set of electrodes forms the cathodes, and the other the anodes, and to address a particular cell, suitable potentials must be applied to the anode and cathode bars forming the cross point concerned.

Although attractive in display flexibility they offer, panel displays have certain inherent problems. The driving circuits are expensive, particularly where a limited number of characters is required—say, a single register of 10 to 20 digits. The most expensive parts of the circuit are the high-voltage (100 volts) drivers required on each column and row, and the read-only-

memory and buffer store required to convert the input information into suitable coded signals for the point or line address system.

A recent tube design reduces the number of drivers required for a row of 16 characters by 90%, but does not eliminate the buffer-store. To eliminate this, the memory can be incorporated within the panel. The most successful approach, announced in 1964 by Illinois University, uses an RC discharge activated by electrodes mounted outside the discharge chamber. But all of these approaches for the display of relatively few characters, using a 7 x 5 matrix, involves an expensive panel, addressing circuitry, or both.

However, if individual tubes are used for such characters, complete flexibility in choice of the length of a register is possible. Moreover, considerable circuit economy can be achieved if the electrodes constituting the cathodes of the 35 discharge cells of the 7 x 5 array are individually connected. Under these circumstances, a circuit similar to that used with stacked-cathode tubes can be employed, in conjunction with a passive decoder.

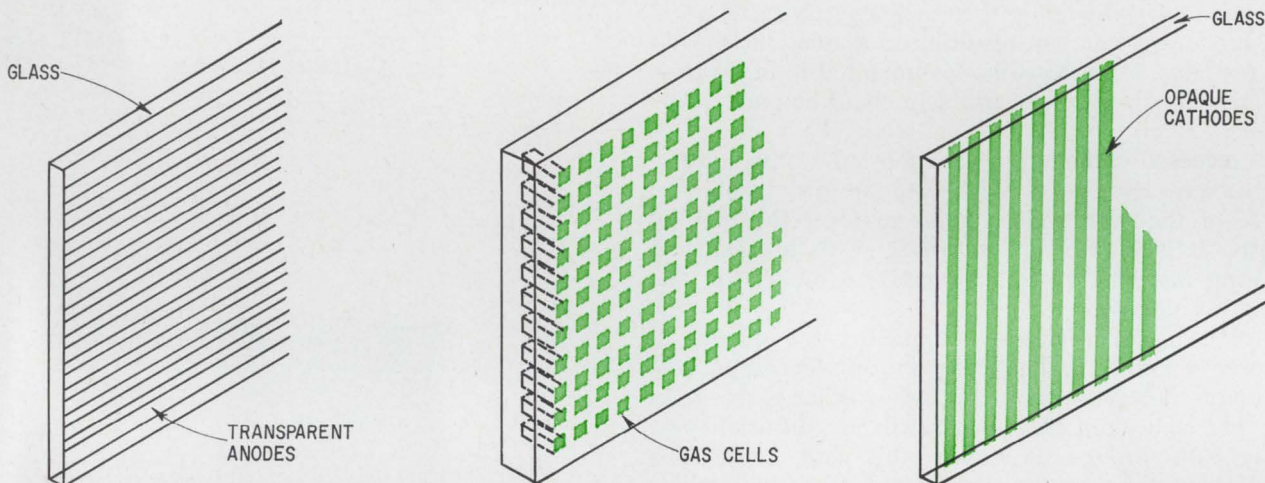

**Panel.** Consisting of three glass plates, the DC panel display's two outer plates have parallel strip electrodes deposited on them. A center plate with an array of holes corresponds to the cross-points formed by the two sets of electrodes, which constitute the gas cell.

**Simple.** The Mullard tube consists basically of only three parts. The flat pack with the glass moulded around the lead frame has a recess above the cathode pads. A photo-etched plate anode and flat viewing window complete the package.

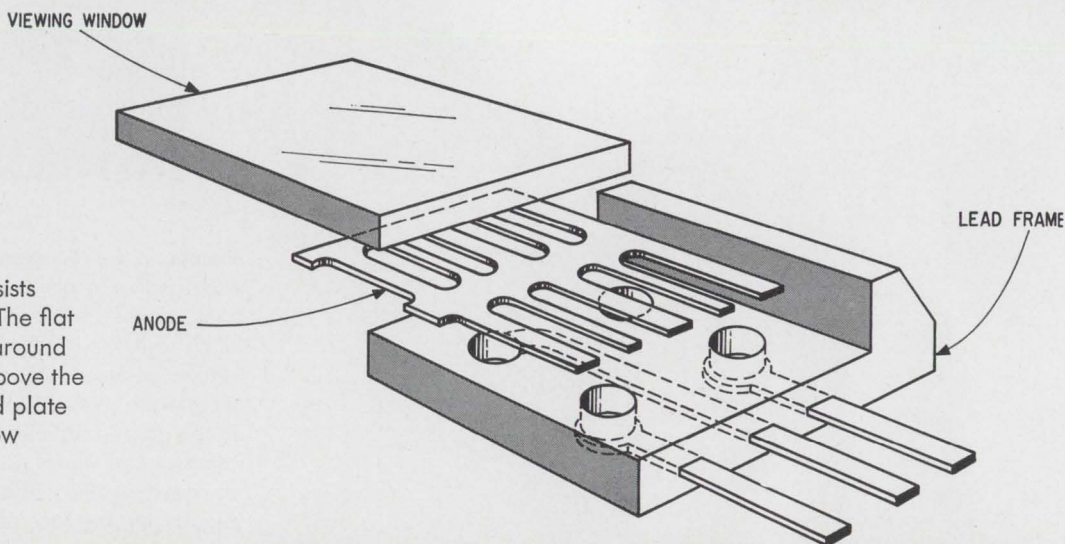



**Flat.** Tube construction is based on flat-pack encapsulating IC techniques. The photo-etched lead frame is moulded into glass to form the flat-pack foot with recessed cathodes and pump stem. The photo-etched anode is then located in the flat pack with its lead passing through the enamel used to seal the window, completing the tube.

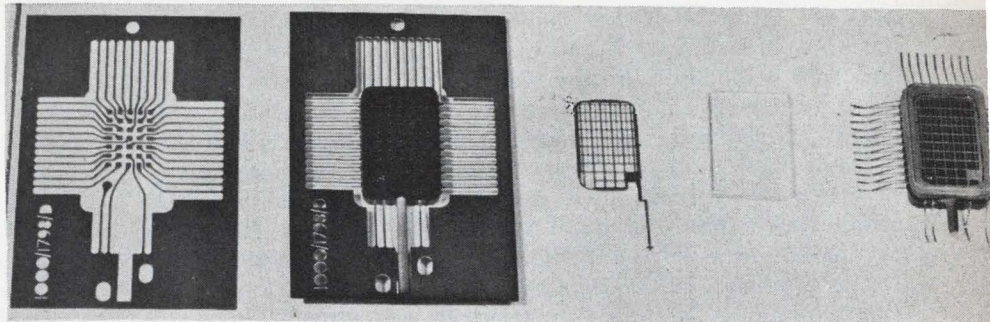

and if controlled, this condition could improve operational efficiency. But even as buildup proceeds, since the cavity wall has a relatively high resistance, the main discharge current still will pass to the base of the cavity, so that discharge conditions are not markedly affected by cavity wall conditions. In this respect the recessed cathode differs from the hollow cathode construction—say a hole drilled in a metal rod—where sputtering from the side walls occurs.

**Laboratory operation** bears out the improved performance. A glow discharge in an experimental tube, using a 1.25 millimeter-diameter cathode pin suitably recessed, has been working for over 20,000 hours to this writing at a current density of 40 milliamps per square centimeter—approximately five times that of normal stacked-cathode tube operation—with no observable sputtering deposit on a glass window placed 3 mm in front of the recess. With neon gas, brightness is approximately 2,700 foot-lamberts, well above brightness. And because the sputtered material does not escape from the cavity, it is possible to remove contamination layers such as oxides from the cathode by the sputtering process. This ensures reproducible values of breakdown and maintaining potentials, which can be held to reasonable tolerance during life. Further, because the glow is recessed within the cavity, its edges are precisely defined, overcoming the severe blurring problem that is often encountered

in other matrix tubes.

In the Mullard design, the 35-dot cathodes are formed by the lead-in connecting wires sealed through the glass foot of the tube. The entire tube consists of just three main parts—the foot, the anode, and the window—which are sealed together in one operation, eliminating the high electrode assembly cost of conventional dot-matrix gas-discharge tubes with their multiple cathodes individually assembled.

To provide this simplicity, a new construction design was used. A matrix tube capable of displaying alpha-numerical characters could be constructed by press-molding the 35 cathode pins into the glass using standard base-making vacuum-tube techniques. However, connections to such a base are difficult, and forming the cavities this way presents serious fabrication problems since it would be difficult to etch back the wires to equal depths.

Instead, Mullard's fabricating technique is based on the flat-pack encapsulating methods used with integrated circuits. This procedure yields simpler base construction and a more compact package. Essentially a "lead frame" is etched out of a sheet of glass-sealing metal to form the recessed cathode pads and connections. This lead frame is then moulded into glass, forming the base and side walls of the tube. In the construction, each cathode pad is positioned at the base of a cavity, the 36 cavities (a decimal point is included) being part of the moulding.

Also incorporated in the moulding is a metal pumping stem. The components, lead frame, pump stem and glass, are loaded into the mould and the process is carried out in one operation. Now all that is required to complete the tube is an anode, which is common to the 36 cathodes, and a viewing window. The anode is in the form of a mesh, etched in a glass-sealing metal, and is mounted 0.5-cm above the top of the cavities. The window is a flat glass plate which, mounted close to the base, will present no distortion, even if not of optical quality.

The window is sealed to the base with an enamel material through which the anode lead can be taken. The whole tube is approximately 19 mm high by 12 mm wide, excluding the pump stem and leads, and only 5 mm deep. Character size is 9.75 x 6.75 mm. The



tube is filled with a neon-argon gas mixture at sub-atmospheric pressure, and is sealed by a cold-weld pinch-off technique.

**This tube design** also offers electrical operation bonuses. Even with the close proximity of the cathodes and the common anode, because the discharge remains in the cavity, the breakdown potential under d-c conditions of any cathode is unaffected by whether or not its neighbors are on or off. Other matrix cathode designs have unstable breakdowns because of the proximity of lit and unlit cathodes. With the recessed cathode construction, the tube can be considered as 35 separate gas discharge diodes with their anodes connected in parallel.

However, a glow on a neighboring cathode, although it won't affect breakdown potential, will reduce the strike delay time—the time that elapses between the application of a pulse and the start of glow. Therefore, for short pulses, 10 - 50 microseconds, a glow will affect the minimum pulse height required for breakdown, the delay time increasing with decreasing pulse height.

Breakdown potential for this matrix is approximately 200 volts, with a spread over the 35 cathodes of less than  $\pm 15$  volts. Also, the maintaining potential at say 150 microamps per cathodes is approximately 130 volts with a somewhat smaller spread, less than  $\pm 5$  volts. However, the driving circuit must also cover spreads from tube to tube and variations during the lives of the tubes, and these will be larger than the spreads within a single tube.

In commercial operational the tube will be pulsed at a difference between maximum breakdown and minimum maintaining potential—a voltage less than 100 volts. Since the cathode area is approximately  $0.4\text{mm}^2$ , the cathode current of 150 microamps gives a current density of  $36\text{ ma/cm}^2$ . The brightness at this current density for neon-argon, which is less efficient but gives lower and more stable voltages, is around 700 foot lamberts, and is clearly visible in a brightly lit room.

**Life test measurements** have shown that the tube can be pulsed at much higher current densities without sputtering the glass, thus offering the chance for considerably brighter tubes. Several tubes have been running for over three thousand hours with a peak current density of  $10^3\text{ ma/cm}^2$ , and a mean current density of  $10^2\text{ ma/cm}^2$ , yielding a mean brightness of nearly 2,000 foot-lamberts. The expected life at a more moderate

**Bright light.** This register of tubes, mounted on a double-sided circuit board, gives a character size  $9.5 \times 6.75$  mm, and its 700-ft-lambert brightness intensity is sufficient for viewing in direct sunlight.

current density is likely to be several tens of thousand of hours.

To operate a 35-dot matrix with full alphanumeric capability requires a drive circuit with a moderately-complex logic capability. To display a character, 9 to 19 of the 35 cathodes must be selected, depending on the character. Thus a pattern decoder is required having 35 outputs and as many inputs as the number of required characters to be displayed.

**To turn on** the selected cathodes, the potential difference between the anode and the selected cathodes must be raised from the normal value below the maintaining potential—approximately 150 volts—to a value above the breakdown potential. This means the switch must withstand about 100 volts. And when the cathodes are ignited, the current must be shared equally between the selected cathodes. This requires a series resistor connected to each cathode, unless it can be incorporated into the coding circuit.

This could be achieved, for example, by using MOS transistors as the drive and decoding circuit in an input-output arrangement. These transistors—144 required for numerals only—would act as cathode current controllers in place of resistors. Unfortunately, with present technology, they cannot be suitably integrated.

Another approach, at least initially, is to use one resistor per cathode, coupled with a diode decoding

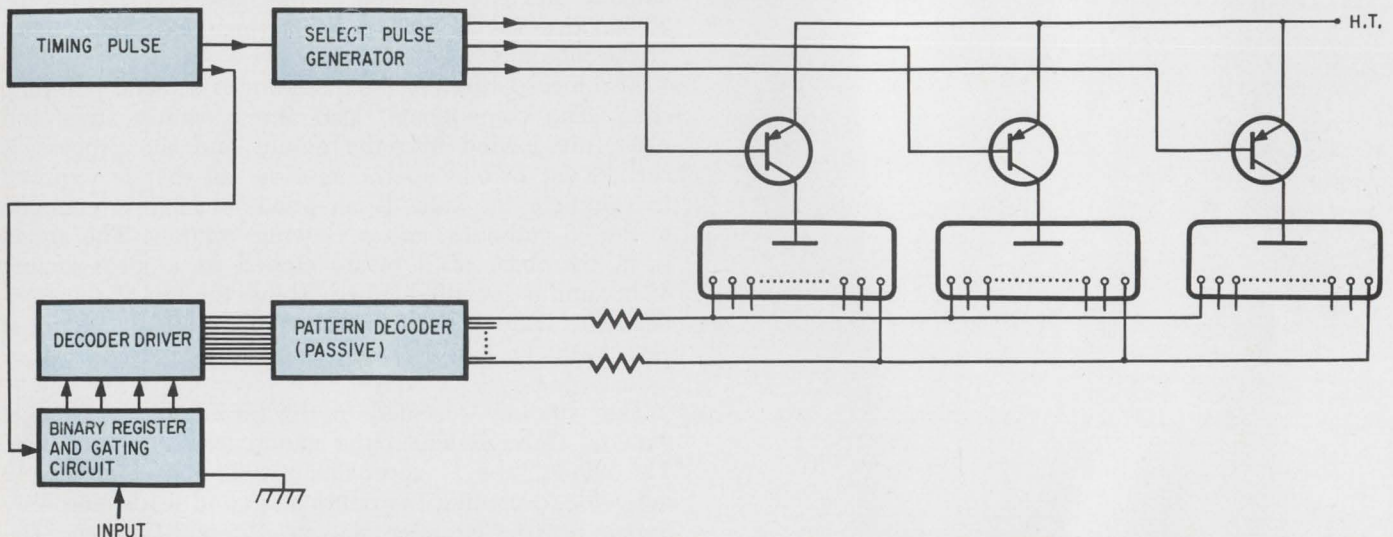



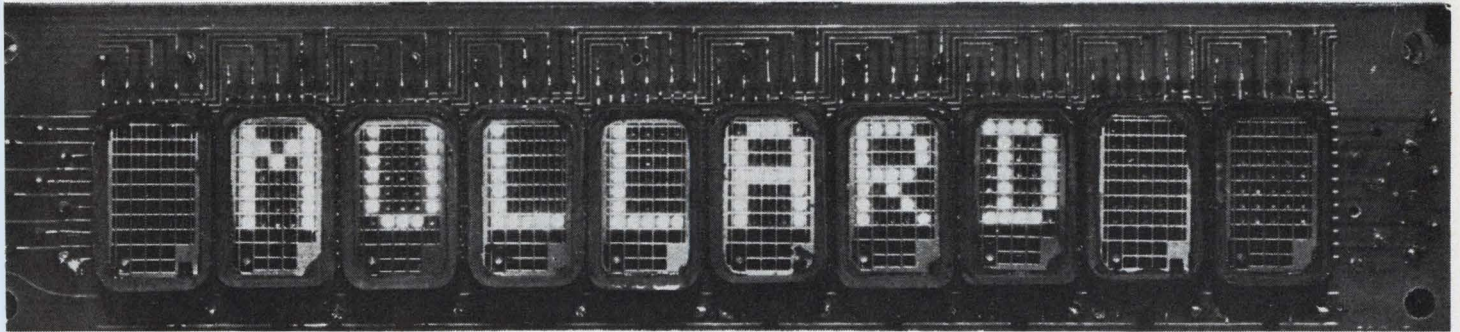

matrix. In this case, considerable economy can be achieved by employing the several combinations of dots in the matrix which are common to a number of characters: for example "E" can be obtained by switching on "F" and "L" together. In this way the number of diodes can be reduced—for example, from 144 to 42 for numerals.

Although such a passive decoder is considerably cheaper than the buffer-store and read-only-memory associated with crossbar matrix display, these circuit requirements, and the problem of connecting to the 35 cathodes, would be formidable, especially if a decoder and a set of cathode resistors are required for each character in the register. However, for digital output, it is not necessary to display a row of characters simultaneously; all that is required is to address each tube sequentially, by switching the anodes at a sufficient rate to present a static display to the eye—a field rate greater than 50 Hz. Known as the dynamic drive system, this sequential addressing allows the cathode drive circuit to be time-shared between the tubes, thus reducing the number of drivers for a register of  $n$  tubes from  $10n$  to  $10+n$ .

The primary function of a dynamic drive circuit is to connect in parallel the corresponding cathodes in a register of tubes that must glow to produce the desired character. For the present tube, just one pattern decoder

and one set of 35 resistors can be used for an entire tube register. For digital readout, the input from a binary counter is fed into a register and gating circuit. The register, or store, is common to all counting circuits. The gating function, required only for dynamic drive, feeds the information from the binary store sequentially to the readout system, in synchronization with the anode switches. This is achieved with a timing pulse circuit, a clock pulse generator which triggers the gating circuit, and an anode pulse selector. The circuits are low voltage and can be built from commercially available integrated logic circuits.

The sequence of binary numbers from the register then is fed into the decoder-driver which provides the necessary switch for driving the display tubes. The cathode driving switch, designed to withstand 100 volts, is obtained by using a binary-to-decimal decoder with discrete n-p-n transistors as drivers. Similarly, the anode switches are discrete 100-volt p-n-p transistors. The decimal numbers are fed via the pattern decoder and current limiting resistors to the 35 cathodes of the tubes, which are connected in parallel.

This parallel connection also aids tube mounting and wiring. Using a doublesided printed-circuit board, the tubes can be mounted less than 2 mm apart by reflow soldering half the leads on the upper side, and wave soldering the rest on the lower side. ●

**Dynamically static.** This dynamic drive circuit for the matrix-display readout switches the anode at a sufficient rate to present a static display to the eye. The cathodes, in a sequential line of tubes, are connected in parallel, and only one pattern decoder and a set of 35 series resistors are required for all the tubes. For numerical display only 42 diodes are used.





# Four-wire performance from a three-wire memory is a valuable, attainable, but demanding goal for designers of 3-D arrays

Pairing sense and inhibit functions on one wire is a logical approach, Electronics Memories & Magnetics' Tom Gilligan says; but designers must be ready to come to grips with a whole new set of problems

● Three, rather than four, wires are being used in some ferrite-core memories to circumvent the problems associated with threading the smaller cores required in faster units. One approach—the so-called 2½-dimensional organization—though popular, requires lots of peripheral electronic circuits and is expensive. An alternative method employs the redundancy of one of the four wires in the standard three-dimensional array. Since the sense wire is used only during the cycle's read portion, and the inhibit wire only during the write portion, both functions can be combined on a single wire.

This approach doesn't require substantially more expensive peripheral circuitry than the standard four-wire array, and it permits smaller cores with faster switching speeds to be used. But this three-wire 3-D design poses constraints, as well as advantages, not shaped by the four-wire format. Understanding these differences and coping with them can yield a valuable design technique for small, fast, low-cost memories.

Among the factors that require attention in the design of a three-wire array are reflections in the line during a sense operation. There are also noise problems that must be compensated for differently than in a four-wire array. But once these factors are understood, a three-wire design with a given core size—that is, with a given speed—can yield a faster and a cleaner design than the corresponding four-wire design.

This is the 17th installment, and the 38th and 39th articles, in *Electronics'* continuing series on memory technology, which began Oct. 28, 1968.



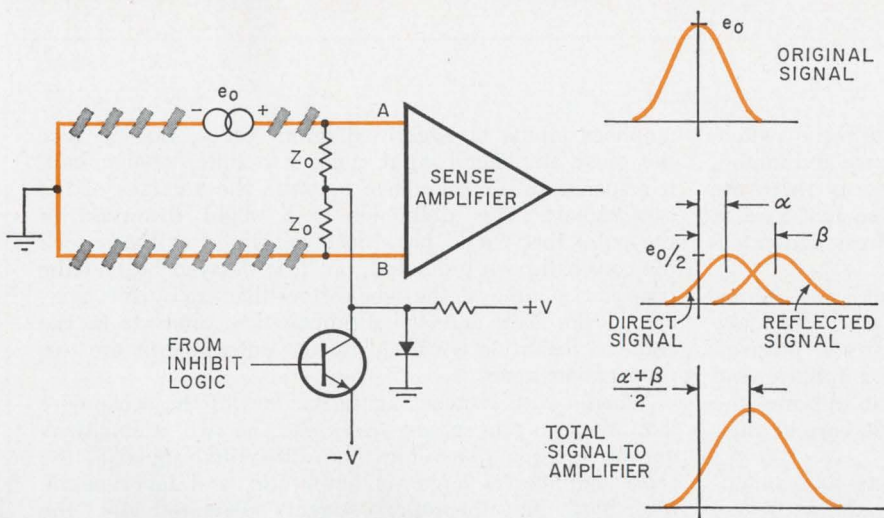

**Driver added.** A current driver can be connected to a sense wire to make it double as an inhibit wire, but the circuit requires a ground return for the inhibit driver. This reflects the sense pulse and provides two overlapping inputs to the amplifier.

A sense line can be made to double as an inhibit line by adding a current driver. There are two places to connect the driver—at the end nearest the sense amplifier, or at the far end where the line doubles back on itself.

If the driver is connected at the near end, as shown above, a ground connection is required at the far end to complete the circuit. In the inhibit driver, the ground clamp on the transistor's collector serves as an equivalent ground during sensing, while permitting current pulses to be driven through the two sides of the sense-inhibit loop. But during a sense operation, the negative side of the generated pulse can't go all the way around the loop to the other side of the sense amplifier, because it is totally reflected at the far-end ground connection. This reflection changes its polarity as well as its direction, and it propagates back toward the sense amplifier, slightly behind the original positive pulse.

When a core switches at the far end of the loop near the ground connection, the direct pulse and the reflected pulse are almost simultaneous, and their sum more nearly resembles the total generated pulse than when a near-end core switches. In the latter example, one pulse arrives almost immediately at the sense amplifier, whereas the other pulse has to propagate all the way down to the ground connection and all the way back; the sum of the two pulses is considerably wider and

flatter than the original total pulse.

Only one side of the sense amplifier sees the sense signal; the other side ostensibly is at ground level. But the ground is established by the connection at the far end of the sense loop, and between the connection and the amplifier are many cores. Current pulses that switch the one core generating the signal also disturb some of these other cores, thus generating delta noise. This noise is caused by the departure of the so-called square hysteresis loop of the ferrite material from perfect squareness; its top and bottom taper off slightly, as shown below. In other words, the ferrite's remanent magnetic field strength is slightly less than its saturated strength, whereas if its hysteresis loop were perfectly square the strengths would be equal.

**To overcome delta noise,** the sense wire in a four-wire array is routed so that it sees half the cores tending to switch from left to right, and the other half from right to left, during a given half-cycle. This routing, shown on page 109, permits the delta noise from half the cores to cancel that from the other half. The exact routing depends on the particular core patterns; different patterns often are used for advantageous peripheral circuit packaging, but all the patterns are equally subject to delta noise.

But no routing cancels the noise perfectly, because no two cores are identical. The difference between non-

**Almost square.** Typical hysteresis loop of ferrite material is close, but not identical, to ideal square shape; departure from ideal is source of delta noise problem.

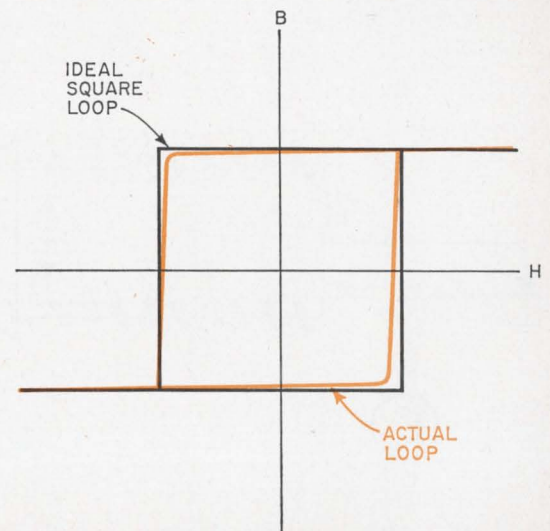



## Four-wire fundamentals

In a four-wire array, the x and y wires perform the switching functions, while the other two are for sense and inhibit. In each plane there are as many y wires as there are columns; but the array is usually square, so that  $x = y$ . These wires are selected in pairs to address individual cores where they intersect.

Each plane also contains one sense and one inhibit wire passing through all cores in the plane. When any core in the plane changes state, it generates a pulse in the sense line that is detected by a sense amplifier. And when the inhibit line carries a current, it opposes the currents in the x and y lines to prevent the core at their intersection from switching.

In the sense wire, a switching core acts like an ungrounded generator whose output is  $e_0$ , as shown below. Because the generator is electrically floating, half of its output,  $e_0/2$ , travels to one input of the sense amplifier; the other half, with opposite polarity,  $-e_0/2$ , travels around the loop to the amplifier's other input. Both pulses are somewhat attenuated by line losses. At the sense amplifier the line is terminated in its characteristic impedance, so that the pulses are not reflected. Because the two branches of the line are of different lengths, the two pulses arrive at the sense

amplifier inputs at slightly different times; but because the sense amplifier's input stage is a differential circuit, it responds to the difference between the voltages of the two signals. This difference is a slight distortion of the pulse that would have been generated at the core if the core had been grounded, but it is delayed by half the propagation time of the whole line—that is, by the average of the long and short propagation times from the core. Its distortion is caused by the difference in the two propagation times.

When a core switches at the far end of the sense-wire loop, the two propagation times and the two attenuations are nearly equal. Therefore, the differential signal at the sense amplifier is larger in amplitude, and more nearly resembles the theoretical signal generated by the grounded core. This difference between near-end signals and far-end signals is quite small for a matrix of 4,096 cores, but increases rapidly for larger arrays.

These variations in pulse shape, timing, and amplitude must be taken into account in the sense amplifier design, which usually includes a strobe to guarantee clean output. This strobe must be timed to occur as nearly as possible at the peak of all the different kinds of pulses that appear at the input.

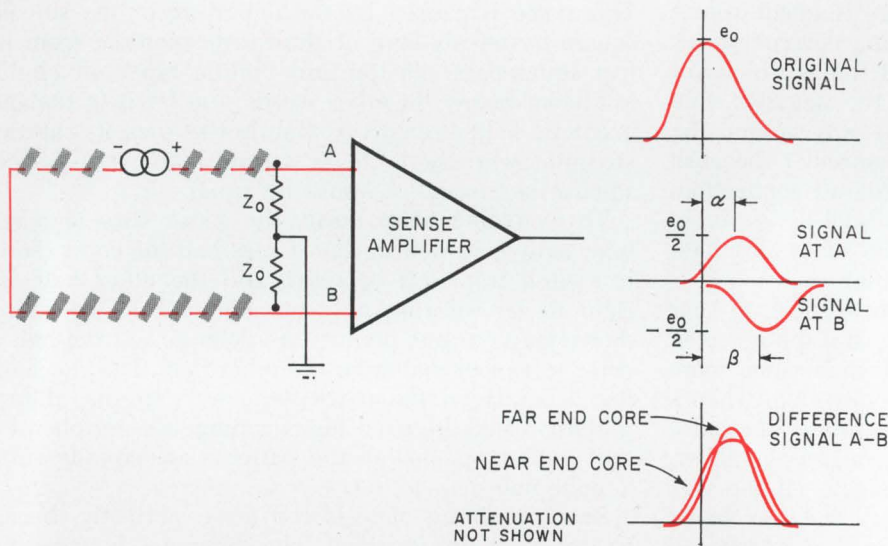

**Isolated sense.** When a core switches in a four-wire array, it generates two pulses of opposite polarity that travel toward the two ends of the sense loop, arriving at the amplifier at slightly different times. The position of a core along the sense wire affects shape of signal received by sense amplifier.

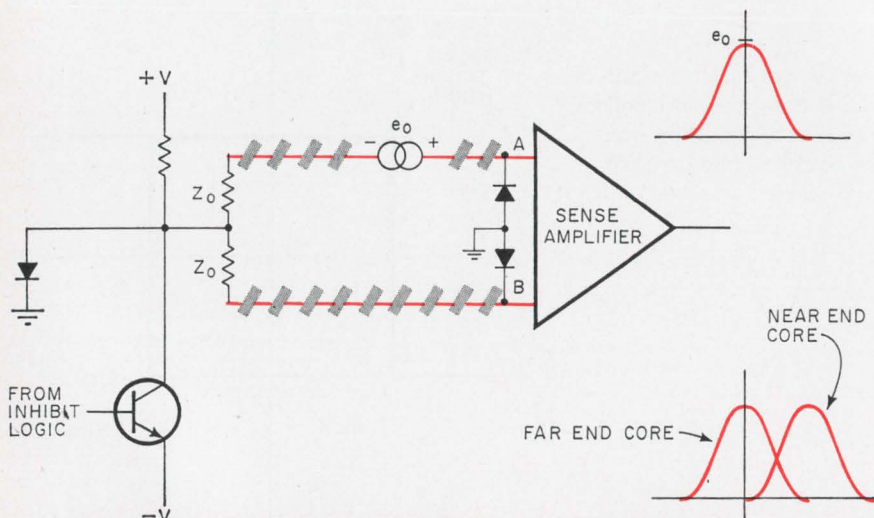

**Far-end driver.** With both current source and impedance-matching resistors at far end of sense-inhibit line, diodes at amplifier pass inhibit current, but present high impedance to sense signals; coupled-in ringing dies out quickly. This configuration permits sense signals to arrive at amplifier at significantly different times, depending on their position on the line.



**Additive.** When one core is selected at intersection of two wires, every other core on those wires generates delta noise, interfering with signal from selected core.

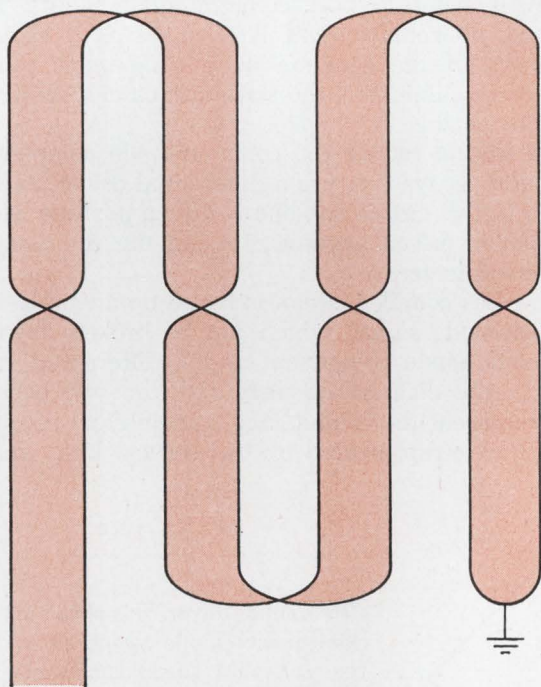
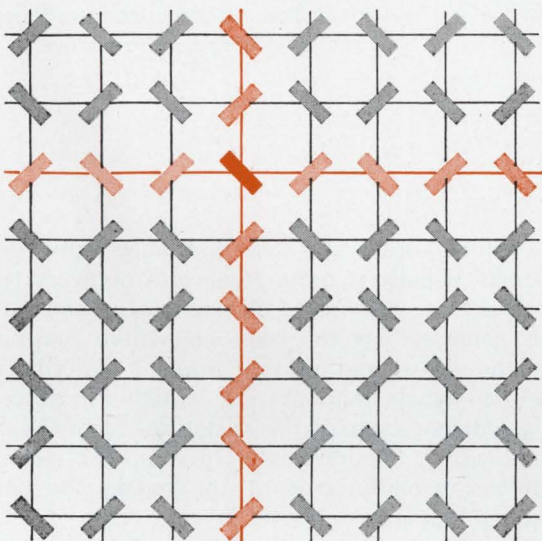

**Bow-tie.** This arrangement of sense-inhibit line cancels delta noise during sense operation while properly directing inhibit current to oppose the write current.

identical cores in a pair creates a residue of noise that wire routing can't overcome—hence the designation “delta”; because the x and y wires thread many cores, the cumulative effect of this residue can be quite significant. For example, in a 4,096-core array, laid out as a 64-by-64 square matrix, each addressing wire threads 63 unselected cores on its way to a single selected core, as shown at left. These 126 cores—62 pairs and two unpaired cores—generate noise that tends to mask the distinction between a 1 and a 0, either of which may be stored in the selected core. The noise exists on both sides of the sense loop.

Routing a combined sense-inhibit wire is subject to an additional constraint. Just as in the four-wire array, the wire must pass through equal number of half-selected cores in opposite directions; but it must also pass through every core in the reverse direction from that of the write current. Since either the write currents or the core orientations alternate from row to row, this constraint is realized with a “bow-tie” winding, shown at left below, that interchanges adjacent rows halfway through the array.

The inhibit driver also may be connected at the far end, as shown on page 106, together with terminating resistors; the near end goes straight to the amplifier, with terminating diodes as shown. In this configuration the sense pulse's negative side is absorbed in the terminating resistor without reflection, while the positive side, arriving at the amplifier's high input impedance, is approximately doubled in amplitude. The amplifier sees only the one pulse; the amount of its phase shift is determined solely by the position of the generating cores. This pulse, in addition to being detected by the amplifier, also is promptly reflected toward the far end of the line, where it also disappears into the terminating resistors.

In the configuration shown, the collector of the inhibit driver is clamped at a level just above ground; this clamp and the two diodes at the amplifier input prevent current from flowing except during an inhibit operation. But when the inhibit logic calls for a pulse, the transistor turns on; its collector drops to a level slightly above the emitter voltage, and a current pulse flows from the diodes at the amplifier to the transistor, through both sides of the loop.

This configuration is most useful in memories made from cores whose switching time is short relative to the sense line's propagation time. It's valuable because such a core generates a high, narrow pulse whose overlap with its reflection in the grounded-center configuration is likely to be small. This would cause the combined pulse to be exceptionally wide and flat, and thus to have a poor signal-to-noise ratio; in an extreme case—such as selecting the core closest to the amplifier—the two pulses conceivably wouldn't overlap at all, and the amplifier would produce a double output.

A third configuration [page 108, top], develops large voltages for fast rise times in high-speed memories. To prevent these voltages from harming the sense amplifier, this design incorporates diodes at the near end. The balun—a transformer connected between the lines, with the polarity of the windings as shown by the dots—assures that currents in the two lines are balanced. Any tendency for the current on one side to increase creates a reduced back voltage on the other side through



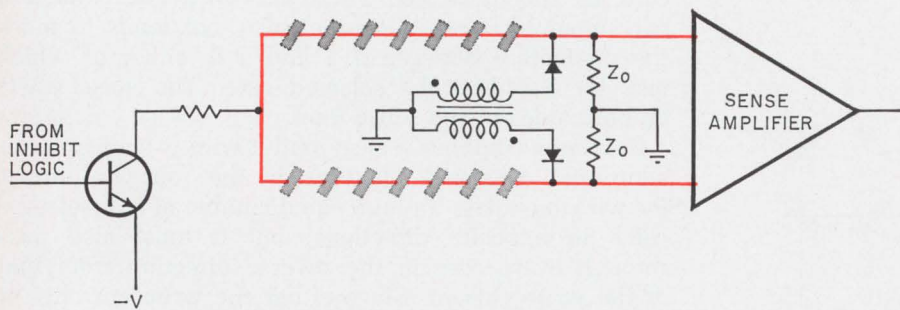

**High speed.** Large voltages with fast rise times can be developed with this connection; diodes prevent voltage spikes from damaging sense amplifier.

the transformer, pulling more current on that other side. Likewise, a decreased current on one side sets up an increased back voltage on the other side.

This connection also has terminating resistors at the near end; the inhibit driver draws current through the diodes and balun. During a sense operation the inhibit driver connection effectively is a short circuit between the two sides of the sense-inhibit line and an open circuit through the driver, so that the operation proceeds as in the four-wire array.

In all these sense-inhibit circuits, both the signal and the delta noise have a common-mode component—one that appears at both terminals of the sense amplifier equally—because one side of the sense loop is effectively at ground level and the entire signal appears on the other side. Another common-mode component is coupled from one of the selection wires which is parallel to the sense-inhibit line in the bow-tie configuration. And still another component is present in the inhibit current when the drivers divide the current equally between two paths; these components, although not generated during a sense operation, may continue to circulate because of ringing, and thus interfere with subsequent sensing.

In the four-wire array, the only common-mode component arising directly from the sense signal is caused by attenuation differences between the two routes from

the switching core to the sense amplifier terminals. This component usually is quite small and not very troublesome. But four-wire arrays do encounter common-mode signals generated by the large capacitive coupling between the sense and inhibit lines. Furthermore, the coupled-in signals tend to ring, which interferes with subsequent sense signals. Most designs have a balun on the inhibit line; this eliminates the common-mode component of the inhibit current and breaks the path for circulating coupled-in current.

Because the sense amplifier is a differential circuit, it can, in theory, ignore common-mode inputs. But in practice, no actual circuit is as good as it should be in theory. If the common-mode component could be reduced or eliminated, the sense amplifier circuit would be more reliable.

**One way to reduce** the common-mode component in three-wire arrays is to use a differential driver, as shown below. In this circuit one line is driven positive while its neighbor is driven negative, forcing the common-mode component to zero.

But a less complex circuit is based on an analysis of a common-mode signal, which can be broken down into a common-mode component and a differential component. In the diagram on page 110, the two horizontal lines represent the inhibit loop, capacitively coupled to another wire represented by the vertical line, which in

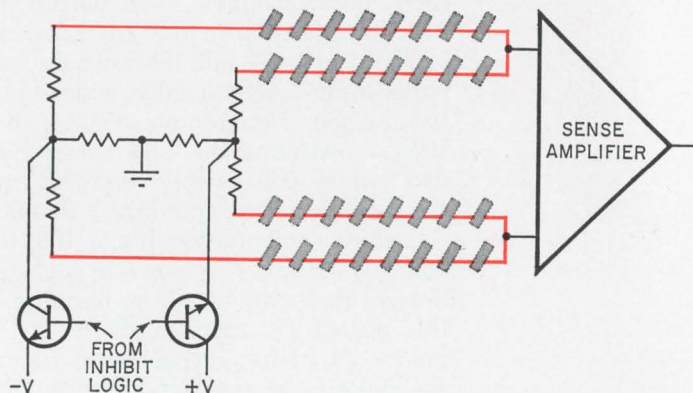

**Differential driver.** This circuit minimizes the common-mode component of inhibit current, which sometimes persists with a ringing effect and interferes with sense operation that follows.







**Coupling circuit.** Common-mode and difference components present in any signal are represented by the three voltage sources shown here. Common-mode component can couple to external circuit, whereas differential component can't—it cancels itself.

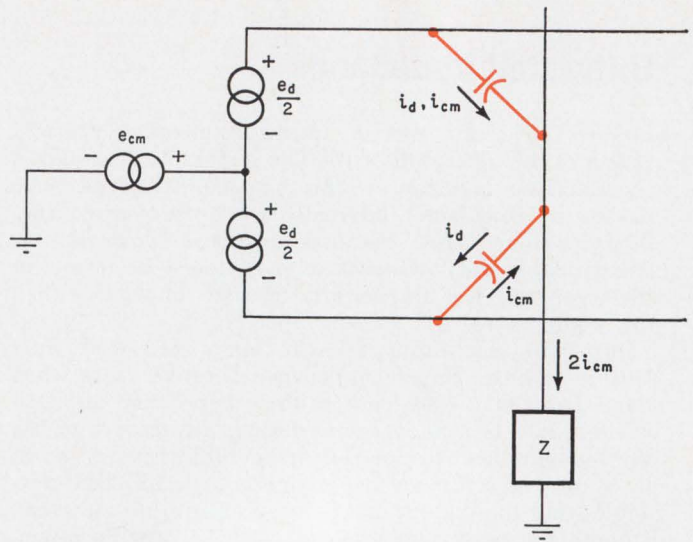

turn is connected to ground through an impedance.

In this arrangement, the hypothetical generator  $e_{cm}$  produces a common-mode signal on both sides of the loop; the two differential generators  $e_d$  add differential signals of opposite polarity to the common-mode signal on the circuit's two sides. The diagram shows that the differential generators supply as much displacement current to the receiving line as they remove from it; thus the net current in the external circuit caused by the differential generators is zero. But the common-mode generator supplies a net current that is not zero. This current varies according to the common-mode potential and the total resistance, capacitance, and inductance in the external receiving circuit. When the common-mode input is large—as it is in a three-wire core array—the design of the external circuit can be critical.

**Basically**, there are two kinds of external circuits, shown in the diagrams opposite. These diagrams illustrate only the passive components, and they show only the connections that affect common-mode current, rather than all the array circuits.

In the grounded circuit, the drive lines are tied down at both ends. The equivalent circuit consists of a capacitance that equals the total coupling between the selection lines and the sense-inhibit lines; an inductance that is the sum of the stack inductance from nonswitching cores and the external inductance of attached circuits and parasitic effects; and a damping resistance. This resistance equals  $Z_0/2N$ , where  $N$  is the number of drive lines. The characteristic impedance,  $Z_0$ , typically is 150 ohms. Thus in a square array of 4,096 cores, 64 on a side, there are 128 drive lines, and the damping resistance is  $150/(2 \times 128) = 0.58$  ohm.

In the open circuit, however, the drive line is open at one end with respect to coupled-in common-mode signals, and it has a high impedance at the other end. The equivalent circuit consists of the same capacitance and inductance as the grounded circuit, but the damping resistance typically is equal to  $4Z_0/(2N)^{1/2}$ . In the 4,096-core array, this is  $4 \times 150/(2 \times 128)^{1/2} = 38$  ohms—almost two orders of magnitude greater than the damping resistance of the grounded circuit. Obviously the open circuit minimizes the need for common-mode suppression in the inhibit circuit—any spurious signals are quickly damped by the relatively high resistance.

This is one of the advantages of the inhibit-driver connection shown on page 106, which had both the driver circuit and the terminating resistors at the far end of the sense-inhibit loop, and no termination at the near end. The connection encounters only a minimum of spurious signals created by common-mode signals and ringing.

**The three-wire array** also affects a memory's power dissipation, inductance, and operating temperature. In a four-wire array, the inhibit wire, whose inductance is  $L$ , carries a current of  $I$  amperes, equal to the write current in one of the two selection wires, but opposite in direction. This inhibit current can be generated by a circuit at one end of the wire and grounded at the other end. The energy stored in the inductive circuit by this current is  $\frac{1}{2}I^2L$ .

But in the three-wire array, the sense operation requires the grounding, if any, to be at the center of the loop, not at the end. Thus the inhibit driver has to provide the  $I$  amp in each of two branches of the wire, for a total of  $2I$  amps. The inductance in each branch is  $L/2$ , and the total inductance of the two branches connected in parallel is  $L/4$ . But the energy the driver must provide is

$$\frac{1}{2}(2I)^2 (L/4) = \frac{1}{2}I^2L$$

This is the same as in the four-wire array. This energy



**Grounded circuit.** Essentials of a sense-inhibit line with coupling to drive lines in a three-wire memory. Here, drive wire is tied down at both ends.

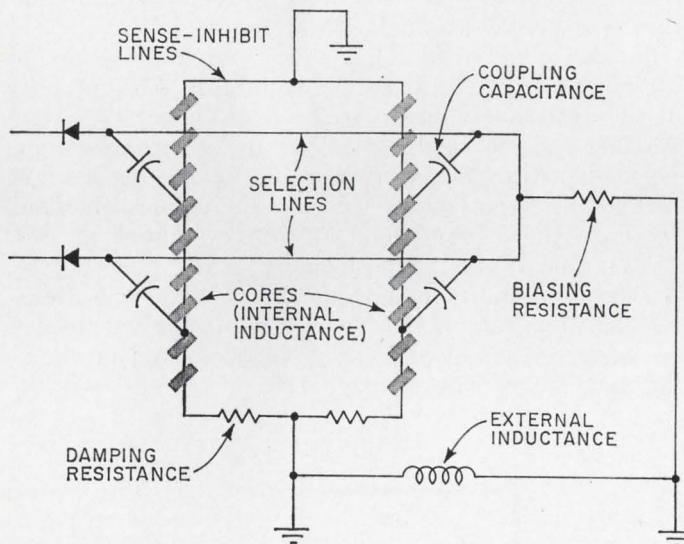
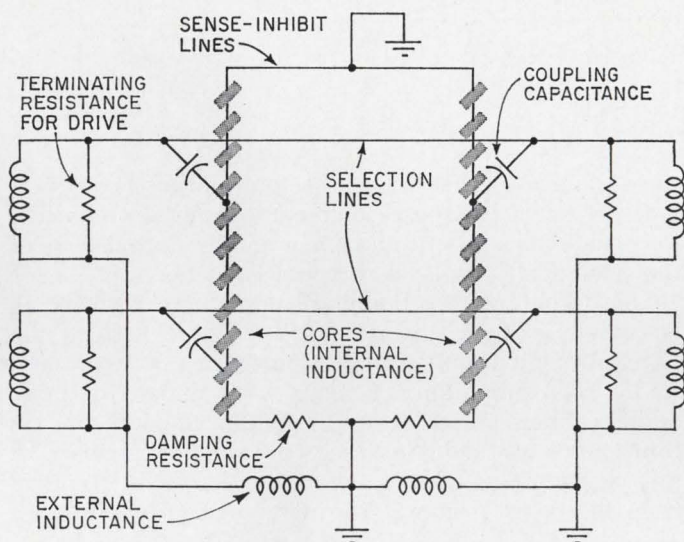

**Open circuit.** Permitting one end of drive line to float relative to common-mode reference and connecting the other end to a bus through a high resistance sets up an equivalent damping resistance about 100 times greater than that in the grounded circuit, largely overcoming common-mode ringing problems.

isn't dissipated as heat; it's stored in the magnetic field of the inductance, which either returns it to the source or dissipates it elsewhere in the circuitry after the current turns off.

A **three-wire array** is much less affected by temperature gradients than the four-wire unit because its sense-inhibit wire dissipates less power. This wire is the major resistive component seen by the inhibit driver, and the power it dissipates is  $I^2R$ . (It's not  $4I^2R$ , because every part of the winding carries only  $I$  amperes.) But since only three wires thread each core, the inhibit wire used with cores of a given size can be larger than in the four-wire array—perhaps by as much as three standard wire-gauge sizes. A difference of three in the wire-gauge number is about the same as a factor of two in the cross-sectional area, and therefore in the wire's resistance per unit length—and therefore in the inhibit wire's power dissipation.

Likewise, a three-wire array presents less of a problem in heat dissipation than a four-wire array, because of its sense-inhibit wire's lower resistance. Cycle time is a designer's first performance criterion, from which he obtains all other design factors. For example, from the specified cycle time he obtains the core size he must use; and with a given core size the three-wire array runs cooler. Suppose he tries to decrease the cycle time of a proven four-wire design by reducing the core size by a given factor  $F$ . Suppose further that he also reduces all other dimensions—wire sizes, wire lengths, mounting hardware, and so on—in the same proportion. He'll find that his proven four-wire design runs hot under these conditions.

What happens here is that in the scaled-down design, each piece of wire, shorter in proportion to  $F$ , has a cross-sectional area that is less in proportion to  $F^2$ . Thus its resistance proportional to its length and inversely proportional to its area, is increased in proportion to  $F$ —and so is its power dissipation. At the same time the areas of all surfaces in the design are reduced by the square of the factor. From the linear increase in power and the square decrease in surface area, it follows that the power density in watts per unit area increases in proportion to the cube of the given factor. This increase in power density increases the temperature of the stack.

The easiest way to cool it is to go to the three-wire design. ●



# There's a read-only memory that's sure to fill your needs



ROM's are handy design tools, say Memory Technology's *John Marino* and *Jonathan Sirota*; take your pick, you're bound to find what you want

● Inside most modern central processors, data handling systems, computer peripherals, and special-purpose digital machines is, most likely, at least one read-only memory. Systems designers now acknowledge it to be a very useful building block and design tool: complex functions can be implemented in a single unit rather than in a distributed fashion. Dramatically highlighting this trend is the control sequence generation now used in central processors. What, in the past, took a great deal of distributed hard-wired logic is now done by a read-only memory with a microprogram.

Today, it's also quite common to find read-only memories applied as code converters, character generators for displays, trigonometric function generators, and process controllers.

In some computer peripherals, for example, where conversion between fixed codes is important, read-only storage units are the best choice. Specifically, a read-only memory can be a character generator converting six-bit code into a pattern in an array of dots; or it can mediate between two computers, or between a computer and a data terminal, that communicate with each other in different languages. And some read-only memories are used for storing large fixed portions of often-used programs, assemblers, and compilers.

Special-purpose computers can be implemented very easily with read-only memories. Depending on the task,

the system can range from a general-purpose computer with a special-purpose read-only-memory controller, to a read-only memory and some simple digital devices for a relatively low-level computational tasks.

Some kinds of read-only memories are also being employed as logic subassemblies. Logic functions can be implemented with read-only memories in two ways. In the more important of these ways, if two or more address lines are addressed simultaneously, the OR function of the data in the two locations appears at the output. The AND function is similarly obtained from the complement of the data, using de Morgan's theorem:  $\overline{A \cdot B} = \overline{A} + \overline{B}$ . This operation corresponds to an instruction built into many general-purpose computers to permit manipulation of individual bits.

In the other read-only-memory implementation of logic, the memory contains the truth tables for a number of different binary functions of a given set of binary variables. Each combination of these variables corresponds to a particular address; the bits in the word at that address represent the values of the various functions for the given combination [*Electronics*, Jan. 5, p. 88].

The type of read-only memory that's best in any particular application depends upon the specifications for that application. However, general statements can be made concerning the various criteria, and are summarized in the table on page 116.

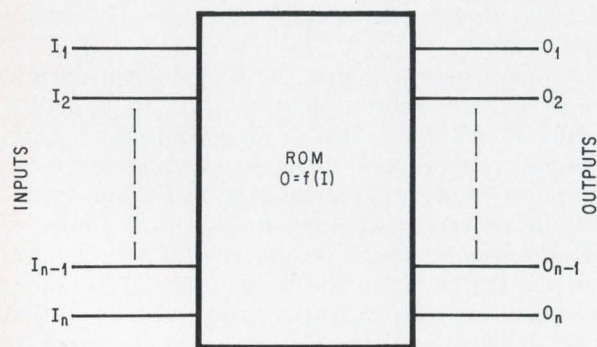

**Relation.** Read-only memory's only function is to maintain a fixed relationship between its inputs and outputs at all times during normal operation.

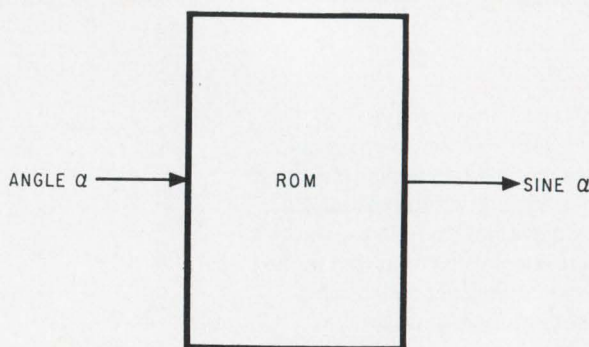

**Trig function.** A good example of a read-only memory application is as a function generator whose inputs are angles and whose outputs are functions of those angles.



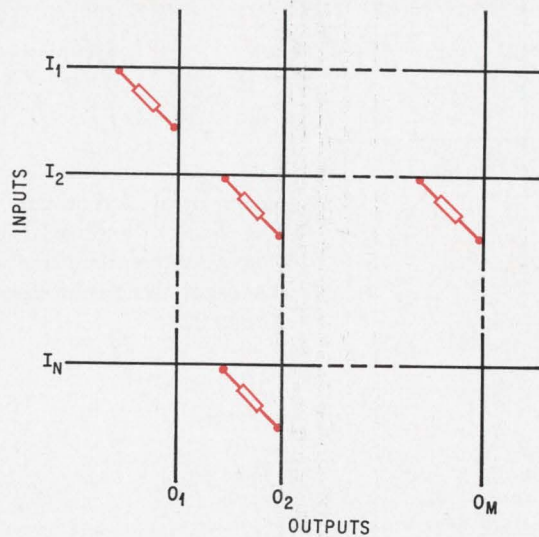

**Matrix.** Read only memory's basic structure is an array of intersections, with a coupling element either present or absent at each to define the stored data.

The read-only memory, despite its rather grandiose name, is only a device that maintains a functional relationship between a set of inputs and a set of outputs, as at left on page 112. This relationship is usually committed to a physical structure that cannot be altered while the system is running; but in a few cases an electrically alterable design has been used. In any case, during normal operation, the relationship cannot be changed by electrical means.

Usually, the read-only memory is considered to have an address for each combination of input variables; information permanently or semipermanently stored at that address establishes the relationship between the memory's inputs and outputs.

The trigonometric function generator is a good example of how a read-only memory stores the functional relationship between inputs and outputs. The input data is simply the angle, expressed in a suitable digital code, and the output data is the sine or other trigonometric function of that angle, also suitably encoded. All of the other applications for read-only memories are just more or less complex examples of this functional relationship.

Basically, the read-only memory is an N-by-M matrix of intersections between a set of input and output data lines, as shown above. Ordinarily, only one of the N inputs can be active at any given time; but, when

an array is used as a logic assembly, two or more inputs can be active. A signal on an input line energizes one or more output lines, as determined by the stored data. The presence or absence of a coupling element at each of the intersections of the matrix determines the data content of the read-only memory; the kind of coupling element determines the type of memory. Practically any active or passive electrical component can serve as a coupling element; in fact, the element need not be electrical—the presence or absence of holes on cards or tape is a familiar form of nonelectrical read-only memory.

**The most commonly used** active elements are diodes and bipolar and metal-oxide-semiconductor transistors; common passive elements in use are resistors, capacitors, and various kinds of transformers, as well as the punched holes previously mentioned. Each of these types of read-only memory is subject to a number of tradeoffs with respect to cost, flexibility, speed, fabrication, external circuits, reliability, ruggedness, capacity, and commercial availability.

Of the commonly used active elements that can provide a connection at each of the intersections of the matrix, the simplest is the diode, as shown below. Two types of diode array memories are in use—those using discrete diodes and those using monolithic diode arrays. In their simplest form, both types use a diode at each intersection in the matrix that corresponds to a

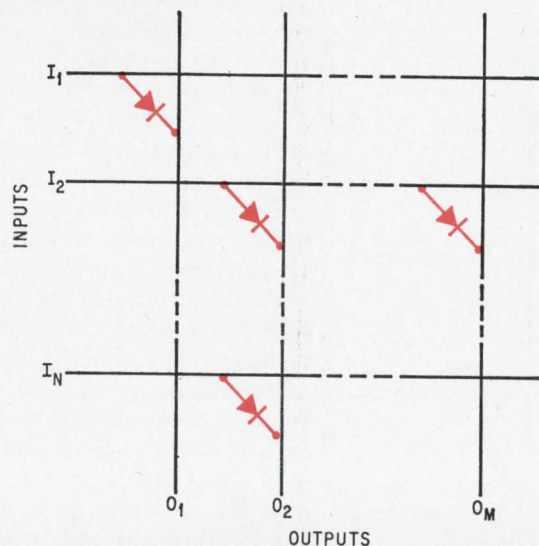

**Diodes.** Simplest active element that can store data in a read-only memory is the diode; the array can be of discrete diodes or a monolithic structure.



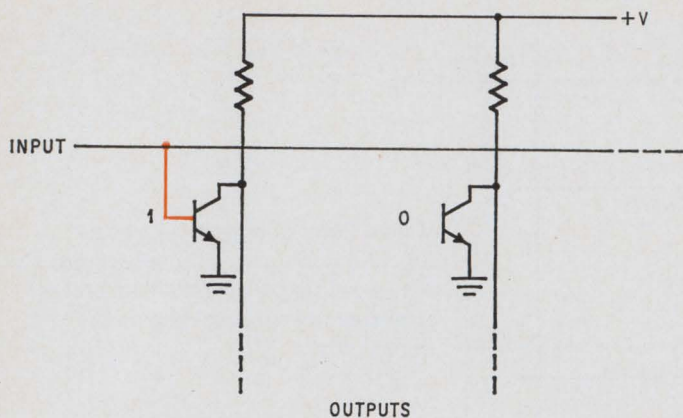

**Bipolar array.** A read-only memory can have bipolar transistors as its storage elements if the presence or absence of a base connection corresponds to 1's and 0's.

binary 1, and leave the other intersections unconnected. But a slight sophistication makes use of de Morgan's theorem: if the number of 1's stored in the array is greater than half the number of intersections, the array contains a diode for each 0, and the inputs and the outputs are inverted. This is particularly valuable for arrays of discrete diodes, because it uses the least number of diodes and, therefore, the least insertion labor.

These discrete arrays are simple and flexible, and are easily built without special equipment, using inexpensive components. But the relative cost per bit for the system, including the peripheral circuits, is fairly high, ranging between 10 cents and 25 cents per bit, largely because of the labor involved in assembling an array. The arrays' flexibility is due to the fact that the stored information can be changed by manual inserting or removing a discrete diode in the array. Their speed is relatively good, ranging from 250 nanoseconds to 1 microsecond.

The external circuits used with a diode memory are very simple. Because the diode matrix is a d-c network, the outputs are the same shape as the inputs; thus, if the inputs are d-c, the outputs are also d-c, so that no output register is required to hold the information.

Discrete diode arrays are very reliable and can be made rugged. In addition, their economical capacity can range from about 100 to 10,000 bits; however, outside

this range, the added cost becomes unreasonable. But there are no discrete diode array systems commercially available as separate products. On the other hand, of course, discrete diodes are available, and most electronically oriented companies can build their own arrays.

**While the monolithic diode array read-only memory** enjoys all the operational advantages of discrete arrays, it is economical only when many memories are required with the same contents. Generating the masks for specific diode arrays is too expensive for a short production run; even automatic equipment that removes particular diodes from a fully populated matrix is too expensive, although it eliminates the mask problem. But by sacrificing flexibility and simplicity, monolithic diode arrays offer significant advantages in speed and physical size, and in cost for large quantities. These advantages are such that small monolithic diode arrays are easily obtainable commercially.

Like diode arrays, monolithic bipolar transistor arrays can be very reliable and rugged and have been introduced by a few large semiconductor manufacturers. However, bipolar fabrication is complex and requires expensive production equipment. Basically, the arrays are fully populated matrixes in which a connection is made from an input line to the base of a transistor wherever a 1 is to be stored; transistors corresponding to stored 0's are left unconnected, as shown above.

While the array's bit capacity ranges from a few to about a thousand, large capacities rapidly become prohibitively expensive. This is true whether the large capacities are placed on single chips or acquired with hybrid assemblies; in the latter case, the interconnection costs increase with capacity at about the same rate as chip costs.

But the speed of these arrays is potentially the highest of any read-only memory type—under 100 nsec. This is considerably faster than the speed of diode arrays, because the transistors don't present the capacitive load to the input that diodes do. On this account, many companies are about to enter the field.

Recently, a great deal of interest in MOS techniques has arisen, because of their application to shift registers as well as to read-only memories. MOS read-only memories, like bipolar memories, comprise fully-populated matrixes with the gate connected to an input for a 1 and left disconnected for a 0, as shown at the left. These

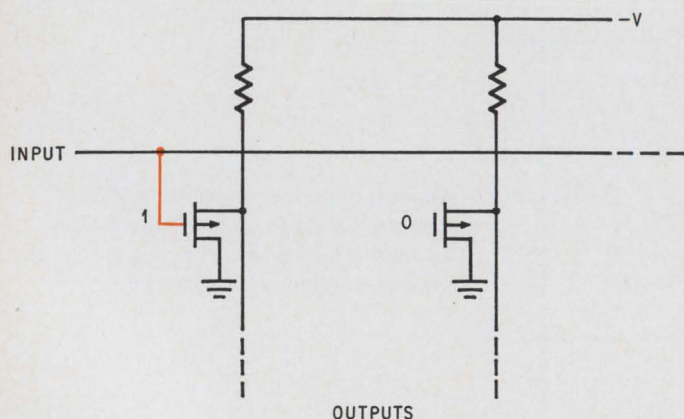

**MOS FETs.** As with bipolar transistors, at top of page, an array of MOS transistors can store data by a gate connection.



arrays include one or two levels of decoding, and store 1,000 to 2,000 bits, each accessible in about a micro-second. In small or moderate quantities, the devices sell for prices competitive with other types, and projected price in quantity is quite low, particularly for larger capacities.

But of those companies that have demonstrated their production capabilities for these devices, few, if any, have demonstrated long-term large-volume capability. Hence, yield and cost is still somewhat doubtful.

Furthermore, like diode arrays and bipolar transistor arrays, the facilities required to produce MOS arrays are extremely complex and costly. Also, the peripheral circuits required to read data from the MOS memory are moderately complex; this is because p-channel MOS, the most common type, uses negative levels and negative pulses, whereas most systems that would use memories are designed with integrated circuitry using positive voltages. Thus, these systems require an interface conversion to enter and leave the memory. This conversion problem is lessened somewhat with complementary MOS circuits, which have both n- and p-channel transistors on the same chip, or with low-threshold MOS circuits; quite a bit of work is being done in both these areas. But none of these units have been in use for a long enough time to provide more than the scantiest data on reliability.

The ruggedness of MOS read-only memories is also somewhat in question; they are susceptible to destruction by excessive voltages on their inputs or by the charge and discharge of static electricity. Again, circuits have been developed to alleviate this problem, but little data on their effectiveness is available at the present time.

**As opposed to** the active elements, the most widely used passive elements are punched tape or cards. Although these systems have been in use for a long time and are familiar to everyone, not many people think of them as a form of read-only memory. Although they are inexpensive, they are also very slow and limited to sequential access.

Resistor arrays, used as read-only memories in some applications, have excellent qualities of reliability and ruggedness. Their cost is usually very low; but the cost of their peripheral electronics is high, because the arrays' operational characteristics are poor—for example, their high power dissipation and low signal-to-noise ratio. The latter is a result of the many sneak paths that exist in the array.

As with diode arrays, the flexibility of resistive arrays is high when they are made with discrete resistors. Monolithic resistor arrays are available which, while they will eventually cost less, sacrifice this flexibility. Resistive read-only memories are capable of high speeds—in the 150 to 500 nsec region—again faster than diodes because of the lower capacitance, but not quite up to the performance of bipolar transistors.

A typical capacitive read-only memory is made from a matrix of plates on either side of a dielectric. These plates are interconnected with a set of parallel conductors on one side of the dielectric, and with another parallel set at right angles to the first on the other side of the dielectric. They are made either by deposition or etching. A high capacitance defines a 1 and a low capacitance is obtained either

by removing a plate on one side or by removing the dielectric between plates. Capacitive read-only memories are in moderately large usage in the data processing industry. However, because their users manufacture them exclusively in-house, cost data is not available; but the memories are probably competitive.

This loyalty continues despite the moderately poor flexibility of capacitive arrays caused by the manufacturing techniques used. However, systems that can be plugged in like a printed-circuit board have been designed around capacitive subarrays. Speeds of capacitive read-only memories range from 250 nsec to 1  $\mu$ sec. These memories, in general, seem to be very reliable and rugged, and can hold up to tens of thousands of bits.

Perhaps the oldest of the read-only memory technologies is that of inductive read-only memories, which have been used in many applications for approximately 25 years. They have usually taken one of two forms. The oldest and simplest of these is a matrix of input and output wires with a discrete toroidal transformer at each intersection where a logic 1 is desired, as shown below. The toroid inductively couples the input to the output. The discrete toroidal array works well, but is costly because the array is handmade.

The other form of inductive read-only memory is the braid transformer array, in which the input wires—one per word—are encoded with data by weaving

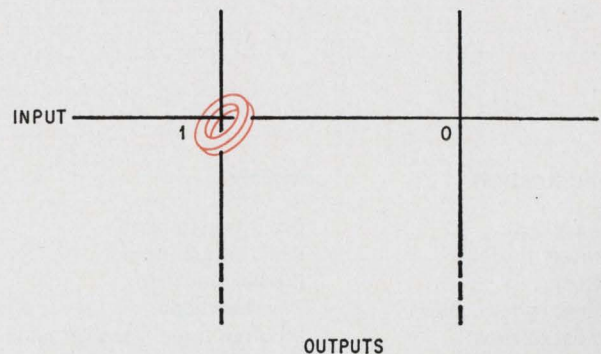

**Old-timer.** A toroidal transformer at each intersection corresponding to a 1 is perhaps the oldest form of read-only memory, but the array is handmade and thus expensive.



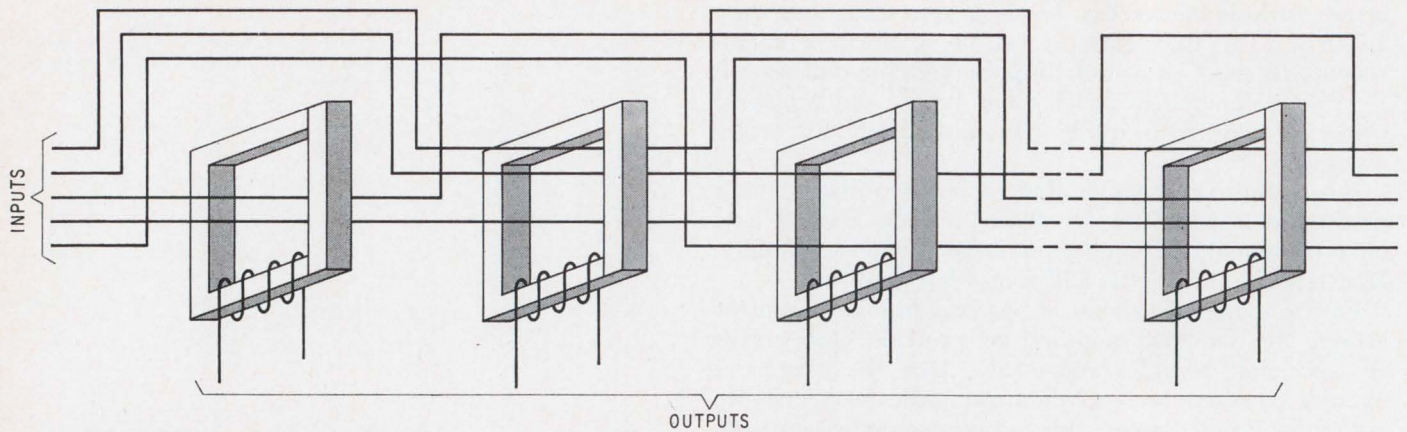

**Up-to-date.** In this more modern inductive read-only memory, word wires pass either through or around successive ferrite cores. A current pulse in a word wire generates a voltage pulse in the sense wire of those cores that it passes through. U-shaped cores have ferrite caps that complete the flux path.

them either through or around discrete transformer cores, as shown above. There is one core for each bit in the word. Only where the wires pass through the cores, are they inductively coupled to the outputs. The cores are U-shaped, so that the wires can be preformed in advance and dropped into place; the preformed bundle of wires resembles a ladder-shaped braid, hence the name. Ferrite caps laid over the U's complete the flux path in the core.

The braid approach has largely replaced the discrete transformer array because of its excellent flexibility, low cost, and capability for high speed—cycle times can be as short as 150 nsec. The braid transformer is being produced presently by automatic machinery, making its cost low. The cost of a braid transformer system varies from 2 cents to 9 cents per bit, including all of the peripheral circuits, depending on the system's capacity. This type of system is very flexible because replacement braids, or arrays of wires, can be made and plugged onto the cores. These braids can be made by a complex machine that automatically interprets the contents of the truth table and weaves the wires accordingly; minor corrections can be implemented very simply and inexpensively by hand.

Another form of transformer array, called the rope memory, contains one core for each word and one wire for each bit in the word. The rope memory is thus

the reverse of the word-per-wire, core-per-bit braid memory. A pulse of current in the core winding of a rope memory makes the core switch from saturation in one direction to saturation in the other, and this change generates pulses in those wires of the rope that pass through the core.

The rope memory has recently, although obscurely, been in the public eye. It stores the program in the Apollo computer [*Electronics*, Jan. 9, 1967, p. 109], which has been largely responsible for the successful navigation and pinpoint landings on the moon. But, in spite of this illustrious role, it has largely fallen into disfavor because it must be handmade—the weaving process for braids can't be applied to ropes. Furthermore, it requires a large drive current and produces very small output signals.

By contrast, the word lines in the braid read-only memory require only small currents, and the pulse transformers can provide large output signals. As a result, the peripheral circuits used for read out can be extremely simple. In addition, the output signals are usually large enough to drive standard integrated circuit logic gates directly; the signal-to-noise ratio of the output signals is about 5 or 6 to 1. The simple electronics also make the braid memory very reliable and rugged. Moreover, the capacity of the braid transformer matrix can range from a few thousand bits to many millions of bits. ●

### Specification

Lowest cost:  
 Greatest flexibility:  
 Fastest:  
 Easiest to fabricate:  
 Easiest to read:  
 Best reliability and ruggedness:  
 Best commercial reliability of components or elements:  
 Best commercial availability of system:

### Matrix

Braid transformer  
 Braid transformer  
 Bipolar transistor  
 Discrete diode  
 Diode or braid transformer  
 Braid transformer, diode or transistor  
 Diode or resistor  
 Braid transformer



# Whatever turns you on.

# Or off.

If you are looking for a faster way to turn on and turn off with TTL, we've got news for you.

Our DCL 8800 series is not only faster than 54/7400, but it gives better overall performance. And if speeds of 13ns suffice, you won't have to pay the premium for 54/74H.

So check yourself and see how the 8800 series works for you.

	<u>FANOUT</u>		<u>t<sub>on</sub></u>	<u>t<sub>off</sub></u>	<u>C<sub>L</sub></u>	<u>\$*</u>
	<u>"0"</u>	<u>"1"</u>				
N8880A	10	20	13ns	13ns	30pF	.85
SN74H00N	10	10	10ns	10ns	25pF	1.58

\*100-999 per manufacturer's, 1/15/70 Price List.  
100-999 Single Type per Signetics Corp. Current Price List.

Interested? Write for your DCL Handbook giving complete details on the 8800 series. Then contact your local distributor for off the shelf delivery.

Of course, if you really need that 3 nanoseconds, we've got 54/74H too.

It's just a matter of what turns you on.

# Signetics

Signetics Corporation/811 E. Arques Ave., Sunnyvale, California 94086/A subsidiary of Corning Glass Works



A  
part  
of  
Union Carbide  
is  
now  
a  
part  
of  
**Solitron.**

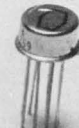

MOS	JFET	LINEAR
<u>Bipolar compatible Memories and IC's</u>	<u>Singles, N and P Channel</u> (2N4416, 2N4220, 2N5114)	<u>Operational Amplifiers</u>
RAM (UC7550)	<u>Dual Matched Pairs</u> (2N5452, 2N3954)	Micropower (UC4250)
ROM (UC7525)	<u>VHF/UHF Amplifiers</u> (2N4417, 2N4223)	741 family
Shift Registers (UC7350)	<u>Switching Junctions</u> (2N4391)	101 family
Multiplexers (UC7410)	<u>Low Noise Junctions</u> (2N5592, 2N5593, 2N5594)	<u>Dual Matched Pairs</u> (2N2920, 2N4044, 2N4878)
Custom Arrays		<u>VHF/UHF NPN Monolithics</u> (UCX2910)
<u>Discrete P-Channel</u> (3N163, 3N166, 3N188)		

**PRODUCT CATEGORIES (and typical part numbers)**

On February 1, 1970, Union Carbide's top semiconductor designers went to work for Solitron. So did their secretaries. So did their plants in San Diego and Tijuana.

If you were a Union Carbide customer, you may be wondering what to do about it.

All you have to do is add Solitron to your list of JFET, MOS and LINEAR suppliers.

And watch for some exciting things to happen. (Soon.) Meanwhile, you can still buy any Union Carbide semiconductor product you bought before. Just buy it from us.

Solitron Devices, Inc., P.O. Box 1416,  
San Diego, California 92112  
Telephone (714) 278-8780  
TWX 910-335-1221





If the move is terminal  
for the terminal,  
you know who's going to hear about it.



You'll get the message if your people aren't getting theirs. Probably one you'd just as soon skip. So maybe you'd better have a nice quiet chat with Allied Van Lines instead.

Allied has highly-trained professionals who know just how to move your electronics equipment—safely and on-schedule.

And our electronic vans are just as good as our personnel. They have a special bracing that keeps your equipment from slipping...an air suspension system that soaks up bumps and jolts along the way.

Call the highly-trained Allied Agent in your area.



**ALLIED VAN LINES®**

**We make the kind of moves  
you never hear about.**

Circle 119 on reader service card



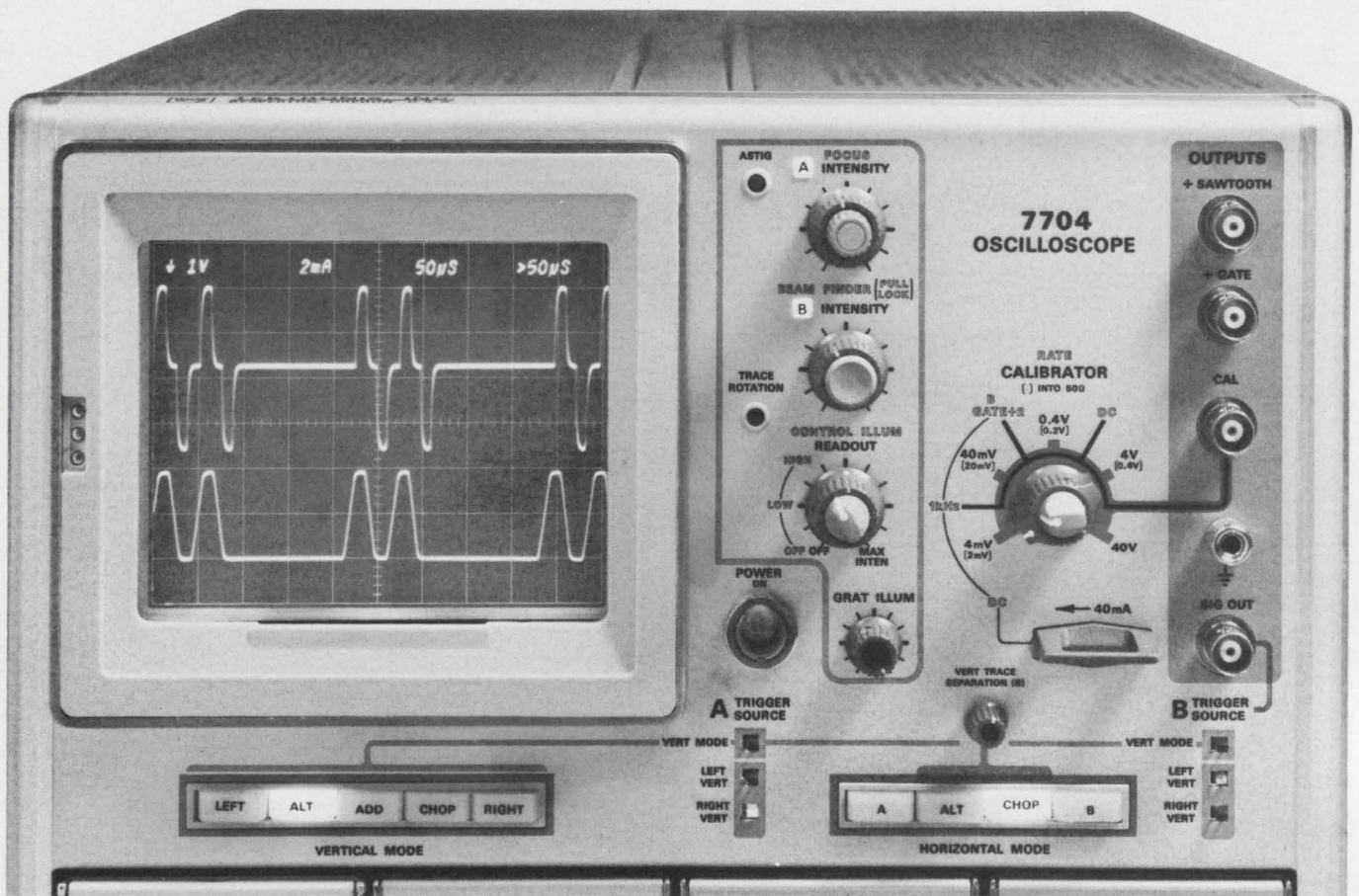

With Tektronix 7000-Series Oscilloscopes

# versatility begins with the mainframe

The New Tektronix 7000-Series Oscilloscopes feature vertical and horizontal amplifiers with dual inputs. This means the mainframe amplifiers can be time shared by up to four plug-ins for unmatched display versatility. Up to 20 combinations of vertical and horizontal operating modes are possible. Simultaneous measurements can be made by multiple plug-ins with widely different features. Voltage and current, real time and sampling, high-gain differential and dual trace, delaying and delayed sweeps are just a few examples. Many applications which formerly required a true dual-beam oscilloscope are now solved by mainframe amplifiers which simulate dual-beam performance.

With mainframe versatility, and four plug-in capability, a wider range of measurement problems can be solved with only one oscilloscope.

Thirteen New plug-ins covering a wide performance spectrum complement the versatility of the new Tektronix four plug-in oscilloscopes. More plug-ins are initially available than in many oscilloscopes even years after introduction. Today, you can choose a New 7704 (150 MHz) or 7504 (90 MHz) Tektronix mainframe with unmatched versatility, confident that plug-ins are ready to solve virtually all of

your multi-trace, differential, sampling, or X-Y measurements.

For measurement ease, Auto Scale-Factor Readout labels the CRT with time/div, volts or amps/div, invert and uncal symbols and corrects for probes and magnifiers. All the data is on the CRT, where you need it to make faster measurements with fewer errors. And, looking into the future, the readout system is designed to meet needs other than those of today's plug-ins. You can solve **more** measurement problems **easier** and **quicker** with an oscilloscope where **VERSATILITY** begins with the mainframe.

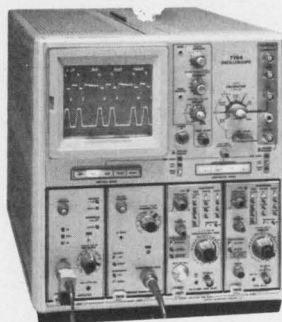

Your Tektronix Field Engineer will gladly discuss with you the complete **VERSATILITY** of the New Tektronix 7000-Series Oscilloscope System. Contact him locally or write: Tektronix, Inc., P. O. Box 500, Beaverton, Oregon 97005. See your 1970 Tektronix catalog for specifications.

Prices of instruments shown:

7704 150-MHz Four Plug-In Oscilloscope	\$2500
7A16 150-MHz Single-Trace Amplifier	\$ 600
7A14 105-MHz Current Amplifier	\$ 575
7B71 Delaying Sweep Time Base	\$ 685
7B70 Delayed Sweep Time Base	\$ 600

U.S. Sales Prices FOB Beaverton, Oregon

## Tektronix, Inc.

*committed to progress in waveform measurement*



# ECL, slumbering speedster, wakes up

With sub-nanosecond speeds and power and heat dissipation problems clearing up, ECL could bite off a 30% chunk of the digital IC market

By Larry Curran  
Electronics staff

**First introduced** by Motorola's Semiconductor Products division as MECL 1 in 1962, emitter-coupled logic is only now beginning to make a significant dent in the digital integrated circuit market. And while it's generally acknowledged that ECL won't dominate the digital IC market to the same extent as transistor-transistor logic does now, and won't be price competitive at TTL-level speeds, the fast logic family is on the brink of great acceptance.

A dearth of manufacturers has been one of the barriers to sharply increasing ECL sales. But sales are ready to swing upward at a sharper angle as the principal computer manufacturers seek to hike the speeds of their central processors, and as semiconductor manufacturers begin to recognize the vigorous market beckoning those who get in at the right time.

Furthermore, now that high-speed semiconductor memories are becoming a reality, another obstacle to adoption of ECL for fast next-generation computers is about to be overcome. As long as core memories were clunking along at cycle times of  $\frac{1}{2}$  microsecond to 1  $\mu$ sec, it didn't make much sense to design a central unit with circuit gate propagation delays of 0.7 nanosecond, the speed achieved in Motorola's infant MECL 4 line [*Electronics*, Dec. 8, 1969, p. 34].

The lack of memories more suited to ECL speeds didn't deter Motorola's Jan A. Narud when he set out in 1961 to design a logic family that vaulted years ahead of its time in speed [see panel, p. 124].

Now, with hindsight, most ob-

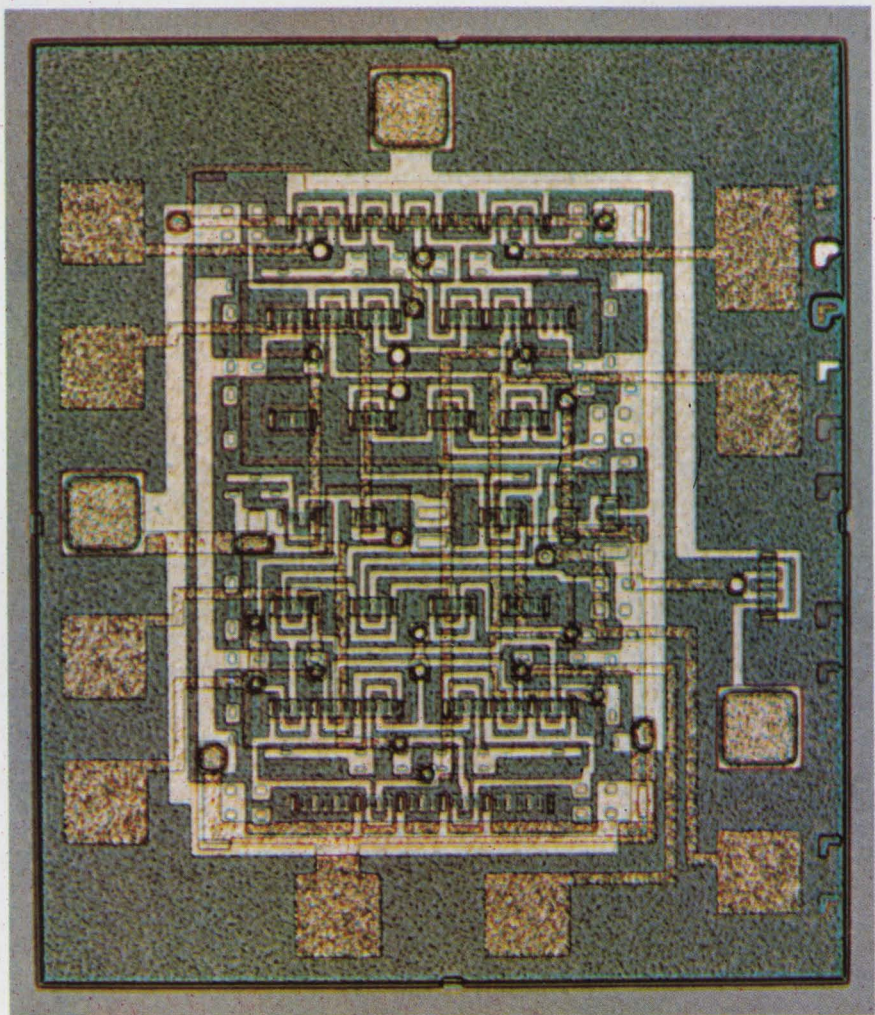

Motorola's MECL 4. Speeds of 0.7 nanosecond have been measured. At 0.9-nsec, power dissipation is as low as 13 milliwatts per gate.

servers believe MECL 1 (with a nominal propagation delay of 8 nsec per gate) was introduced before there was a market for it—an unusual situation for Motorola. And though MECL 1 and 2 (propagation delay of 4 nsec per gate with some

circuits at 2 nsec) sales haven't been earth-shaking.

Even now, though, ECL sales are far from insignificant. The figure for all current-mode logic jumped from about \$19 million in 1967 to \$26 million in 1968, then



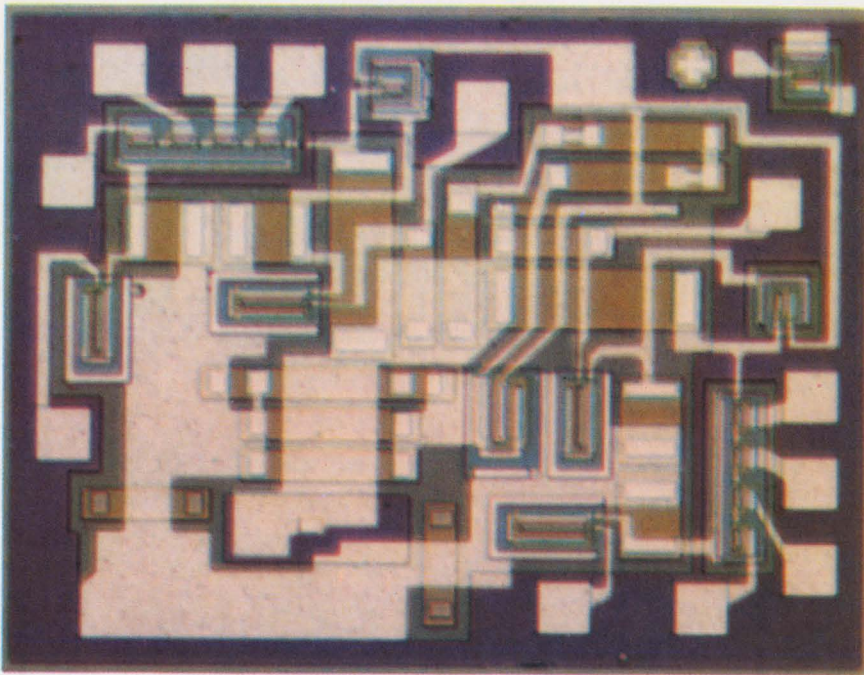

**German ECL.** Siemens, believed to be the largest ECL manufacturer in Europe, builds this dual, four-input NOR/OR gate.

dipped slightly to an estimated \$25 million last year in a total digital market of about \$331 million. But engineers at Motorola and Texas Instruments, the two biggest ECL producers after IBM, predict that this share of market will climb to between 25% and 30% over the next three to seven years.

Among the most bullish ECL men is Gene McFarland, product marketing manager at TI's advanced circuits operation in Sherman, Texas. He predicts ECL could own 15% to 30% of the digital market by 1973 as machines now in design move into production. "Because of the end use," says McFarland, referring to ECL's application to the central processors—and some memories—in large computers, "when it goes, it's going to go big."

The longer view is taken by Motorola's James Heinchon, group leader for digital IC product marketing at the Semiconductor Product division. He expects ECL's share of market to grow to 11% or 12% by 1972, possibly to 13% to 14% in 1973, and if growth holds at the rates Motorola projects, ECL could nail down 25% of digital IC sales by 1977.

Michael Callahan, manager of integrated circuit R&D at Motorola, who's worked with Narud since

the early days of ECL, predicts the logic will have about 20% of the digital market sometime between 1973 and 1975. "But even if it's only 10%, the total digital market by then is expected to be \$1 billion, so \$100 million is a significant business," Callahan asserts.

Signetics' George Anderl, product manager for current-mode logic, bullishly predicts the ECL market will reach \$200 million by 1974. "However," he adds, "it might be held back by high-speed TTL circuits." In 1974-75, Anderl sees current-mode logic and TTL neck and neck.

In Europe, both Garnot Oswald, Siemens' marketing manager for IC's, and Wilfried Dollt, who handles AEG-Telefunken's IC product planning, figure ECL accounts for less than 10% of German IC sales now, but the two are sharply divided over the future. Both firms manufacture and use ECL in their own computers, and Siemens is believed to be the largest ECL manufacturer in Europe. The German IC market is expected to run between \$35 million and \$40 million this year.

Siemens' Oswald sees ECL's share of market dropping even as total demand rises, principally because the demand for other types of IC's, particularly TTL, will grow

at a much faster rate. AEG-Telefunken, on the other hand, predicts ECL will have a 15% share of the German market by 1973, depending on when the next-generation computers hit volume production.

**Chasers.** But notwithstanding the varying predictions, there's no doubt the market is there. It's ripening quickly, and a number of semiconductor companies are preparing to grab a piece of the action. As Motorola's Callahan puts it, "If there's a \$100 million to \$200 million market by 1973-75, everyone will be chasing it." In fact, many more companies are producing ECL; TI got its biggest boost by being chosen as ECL supplier for IBM's 360/85 and 360/195 machines. One source says the whole program, for the 360/85 and probably the 360/195, will be worth \$50 million to \$100 million to TI before be now through 1972.

The first firm to get on Motorola's then-sluggish ECL bandwagon by second sourcing was Stewart-Warner's Electronics division, which still provides portions of the MECL 1 and 2 lines (series 300 and 350 MECL 1, and series 1000 to 1200 MECL 2). But MECL dollars account for less than 10% of Stewart-Warner Electronics' sales. More recently, Signetics signed an agreement with Motorola to second-source some MECL 2 devices, and it's believed that any new current-mode logic circuits Signetics produces will be added to the MECL 2 line under this agreement.

RCA is in the ECL game with a family it calls emitter-coupled current-steered logic (ECCSL). A developmental unit designated IA5747 provides complementary OR/NOR outputs, a wired-OR capability, and a propagation delay of 1.4 nsec with power dissipation of 35 milliwatts per gate. Arthur Liebschutz, marketing planning manager for high-speed digital IC's at the Electronic Components division, says this speed-power factor of approximately 50 is about twice as good as the best TTL figure.

The RCA speed-power product is not as good as the figure Motorola's Callahan cites for MECL 4, with an expected propagation delay of 0.7 nsec and power dissipation of 50 mw per gate. But if the circuits are slowed to 0.9 nsec, power dissipation is reduced to just 13 mw per



# Panel design ideas from Dialight

Many different push button cap and bezel options permit custom panel designing with standard switches and matching indicators. Designers and engineers are welcoming these low-profile, snap-in-mounting push button switches that are interchangeable with most 4-lamp and 2-lamp displays. Units available in  $\frac{3}{4}$ " x 1" rectangular,  $\frac{3}{4}$ " square,  $\frac{5}{8}$ " round and  $\frac{5}{8}$ " square designs. Bezels with or without barriers in black, gray, dark gray or white. Legends are positive or negative—either visible or hidden when "off." Switches are momentary or alternate action and low level to 125V at 5A, resistive.



Bezels with or without barriers in black, gray, dark gray or white. Legends are positive or negative—either visible or hidden when "off." Switches are momentary or alternate action and low level to 125V at 5A, resistive.

CIRCLE READER CARD NO. 250.

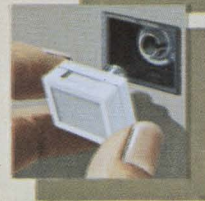

**Snap-in bezel simplifies mounting. Fingertip grip permits easy cap removal.** These switches and indicators are easily slipped into mounting cutout for a snug fit. No

tools are needed. Fingertip grip makes push button cap installation or removal an easy job. Caps come in a full range of colors or with underlying color filters. Each cap has a metal insert that

receives T-1 $\frac{3}{4}$  bulb with midget flanged base. Mounting cutouts may be made for individual units or for groupings of two or more units in horizontal or vertical panel configurations so that many different arrangements are possible.

CIRCLE READER CARD NO. 250.

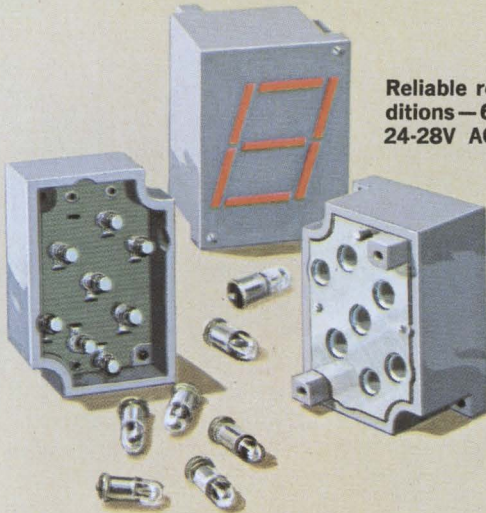

**Reliable readouts for high ambient lighting conditions—6V AC-DC, 10V AC-DC, 14-16V AC-DC, 24-28V AC-DC, 150-160V DC or 110-125V AC.**

You can read these readouts in a bright room from any viewing angle up to 30 feet away. Sharp seven segmented characters are formed by patented light-gathering cells (U.S. Pat. No. 3,210,876). They're designed for use with high-reliability neon or incandescent lamps to meet a variety of circuit voltage requirements. Separate BCD to 7-line translator driver. PC boards also available. Modules directly compatible with integrated circuit decoder drivers now universally available.

CIRCLE READER CARD NO. 251.

**Wide selection of Datalites® and subminiature indicators are among 1,500,000 visual indicators available to designers.** It's now easier than ever to select the units that meet your panel and circuit requirements from the many thousands of Datalites and subminiature indicator lights available from Dialight. Variety of lens shapes, colors and finishes. Many different positive or negative legends. Incandescent 1.35-120V; neon—high brightness at 110-125V AC and standard brightness at 105-125V AC-DC. For clearance holes from  $\frac{9}{32}$ " to  $1\frac{1}{32}$ ".

CIRCLE READER CARD NO. 252.

New 56-page Product Selector Guide provides data on 1,500,000 readouts, switches and indicator lights. Get your copy today.

CIRCLE READER CARD NO. 253.

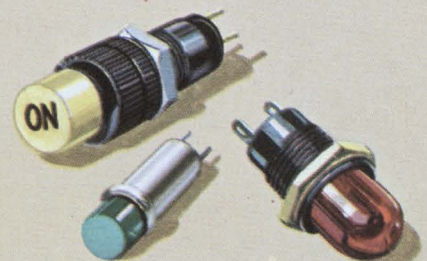

## DIALIGHT DIALCO



## The speed-seeker

The man who holds the patent on emitter-coupled logic has been concerned with the need for high speeds in data processing since computers were in the research stage at Harvard's Computation Laboratory. Jan A. Narud taught there at the time, and so did C. Lester Hogan, who went on to head up Motorola's fledgling Semiconductor Products division in 1958. About the same time, Narud went to work for IBM at its Yorktown Heights research facility.

"I learned," the Norwegian-born Narud says, "that the cost for information processing was proportional to machine speed. The Atomic Energy Commission, for example, needed propagation delays of 30 nanoseconds per gate as early as 1952." That was a pretty fantastic requirement for its time, but Narud was doing an order of magnitude better by 1961, after Hogan asked him to join Motorola when the semiconductor Products division made its big IC commitment.

Narud decided to make high-speed circuits for computer-control functions and arithmetic units, and current-mode logic was born that same year at Motorola. Narud achieved speeds as fast as 3 nsec propagation delay in laboratory devices then, but even at 5 nsec, Motorola's first ECL (MECL) IC's were, Narud says, an order of magnitude faster than any other logic.

Narud shares the ECL patent (no. 3,259,761, issued July 5, 1966) with Walter Seelbach, who left Motorola shortly after Hogan and joined him at Fairchild Semiconductor. Many at Motorola believe MECL was put on the market prematurely in 1962, and while early MECL sales bear them out, Narud disagrees.

"I think this is a myth," Narud



asserts, "because most people didn't realize how long it takes to design a huge, high-speed system. If you're going to build something in a next generation computer, you need a lead time of two to five years. Sophisticated computer manufacturers picked the ECL idea quickly," Narud says.

In any event, it's doubtful Motorola would have been reaching speeds of 0.7 nsec delay per gate with its MECL 4 circuits—already being designed in by some customers—if Narud hadn't blazed the trail almost nine years ago. As director of computer-aided circuit design, he has been "intimately involved" with the R&D aspects of MECL 3 and 4. He undoubtedly finds considerable satisfaction in the rosy outlook for ECL as more and more computer, instrumentation, and communications systems manufacturers seek it for new designs. It also must be gratifying to Narud to have been instrumental in getting Motorola into the technology first, for a change. The division is more respected as a high-volume producer than an innovator.

gate. Motorola's goal in MECL 4 is to give the computer designer super speed while reducing his thermal problems through minimizing power dissipation. MECL 3 is rated at 1 nsec propagation delay with 50 mw per gate power dissipation.

And then there's Philco-Ford's Microelectronics division, which has achieved propagation delays of just 0.5 nsec to 0.8 nsec and an

average dissipation of 7.5 mw per gate on a 120-mil-square chip holding 100 gates and using three layers of metallization. This kind of performance could make Philco-Ford a power to be reckoned with in ECL. It remains to be seen if the firm can translate this kind of performance into reproducible volume production, but Robert Luce, manager for advanced devices at the Bluebell, Pa., microelectronics

facility, says Philco-Ford has been supplying ECL to MIT's Lincoln Laboratories "for some time."

Advanced Memory Systems is another firm backing ECL. The Mountain View, Calif., company is a new entry into the semiconductor business, specializing in memories based on ECL components. The firm recently added memory subsystems to the ECL memory component business in the form of a mass memory, holding up to 8 million bytes, that fits between cores and disks or drums in speed.

**In the wings.** Still to be heard from is Fairchild. An announcement that the semiconductor division is in the ECL business is expected, possibly by next month; with C. Lester Hogan as president of Fairchild Camera and Instrument Corp., it's doubtful that he'll ignore a technology so close to his heart from his Motorola days. And with Walter Seelbach, co-holder of the ECL patent with Motorola's Narud, now in the Fairchild stable, it's a cinch that Fairchild will be in the game if the judgment is that it makes good business sense. Seelbach was one of the prime movers behind MECL 3 at Motorola. With his experience in designing high-speed, multilayer metalized ECL bordering on the medium-scale integration region, Fairchild may be opting to hit the market with ECL at MSI complexities.

In addition to Siemens and AEG-Telefunken, Japan's Hitachi and the United Kingdom's Plessey Co. and Mullard, a Philips subsidiary, are other non-U.S. firms known to be manufacturing ECL. Plessey developed devices like those in the faster MECL 2 line, with a propagation delay of 2 nsec. Siemens' 100 series ECL consists of three types of NOR/OR gates in glass flatpacks, with speed rated at about 5 nsec. AEG-Telefunken is best known for its SECL (symmetrical ECL) line with speeds as great as 0.9 nsec [*Electronics*, Jan. 5, p. 142]. The firm also has nine other circuits in production that are similar to some of the MECL family.

Both Siemens and AEG-Telefunken are their own biggest customers for ECL, with Siemens using it in its 4004 computer family, and AEG-Telefunken's TR 440 machine the principal user of that firm's



# Meet Skinny Mini.

The first  
2 amp 2PDT relay  
skinny enough  
to mount on  
0.5 PCB centers.

Never has anything  
so flat caused so  
much excitement  
... since Twiggy.

Here she is, the skinniest, miniest 2 amp 2PDT relay in captivity. Only 0.340 inches maximum off the board height.

Cheaper than a crystal can! Handles more power than a TO-5 relay! Has versatility of Form C compared to Pico-reeds! And is smaller than all other 2 amp industrial relays!

Now Skinny Mini, or as she is sometimes affectionately called, Midtex/AEMCO Type 181, with its maximum off-the-board height of 0.340, mounts neatly on printed circuit boards using 0.5 centers. The height is also compatible with semiconductor component mountings.

Skinny as it is, the 181 provides 1/16" clearance through air and 1/8" over surface. Terminals are 0.025" diameter square pins. The relay mounts on four raised pads to permit proper PCB cleaning and soldering.

Skinny Mini . . . the skinniest news to hit the relay market this year. For more information about Mini, write or call Midtex/AEMCO, 507 388-6288, or see a Midtex/AEMCO representative.

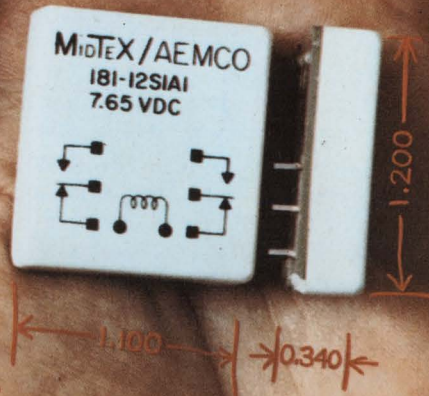

*Cheaper than  
crystal cans  
Handles more power  
than a TO-5  
More versatile  
than Pico-reeds  
Smallest 2 amp  
industrial relay*

**MIDTEX**   
INCORPORATED

10 STATE STREET  
MANKATO, MINNESOTA 56001

PROGRAMMERS/TIME DELAY RELAYS  
MINIATURE COAXIAL RELAYS/INDUSTRIAL RELAYS  
MERCURY-WETTED CONTACT RELAYS



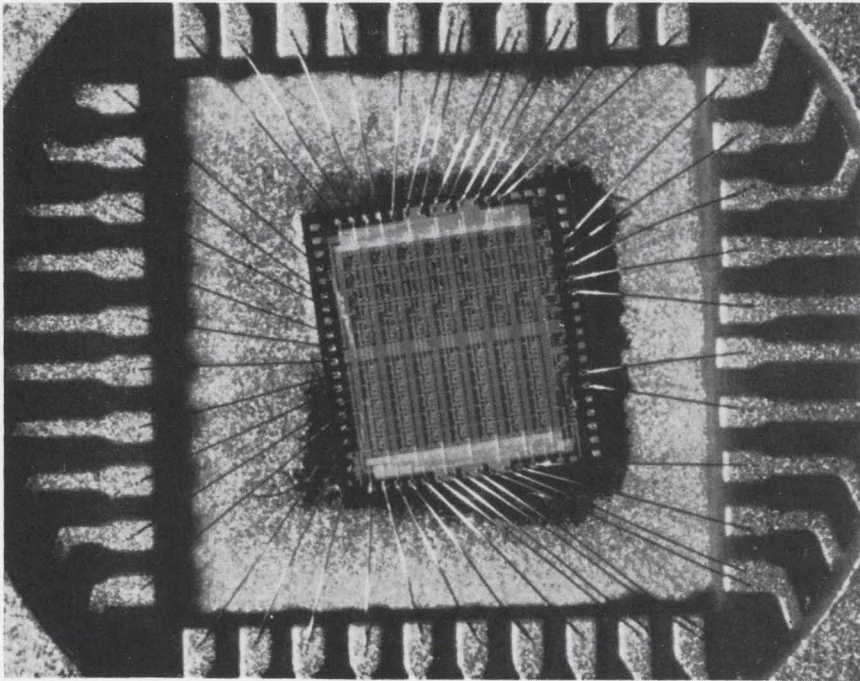

**80-gate ECL.** Packaged Philco-Ford chip contains 80 gates, which operate at speeds of 0.6 to 0.7 nanosecond at 7 to 10 milliwatts of power.

line. Plessey's circuits are being used by International Computers Ltd., the British consortium, which also buys MECL from Motorola for the largest computer in its 1900 range, the 1906A.

Current-mode logic has penetrated the Iron Curtain, too. Motorola's Narud was a member of a cultural exchange delegation to the Soviet Union, where he saw current-mode logic being used in a large computer central processor. "In one instance," he reports, "they were copying MECL 2 right down to the mask level."

**Speed is everything.** Speed is still the overwhelming reason computer manufacturers are swinging to ECL. New TTL circuits using Schottky diodes to avoid saturation—such as those being produced now by Intel, Raytheon, and Ferranti, and perhaps soon by Fairchild—represent a threat to ECL because they offer higher output swings, higher signal-to-noise ratio and less stringent tolerance requirements in processing. But as one AEG-Telefunken source puts it, "It's speed that gives ECL the edge, and as things stand now, it's this circuit concept that will yield the better speeds required," 1 nsec or less, of future machines.

Motorola's Callahan agrees with this assessment of the ECL-vs.-

Schottky-TTL question. He says Schottky TTL may be a factor at 3 nsec, but "it won't impact the 1 nsec and sub-nsec regions. It's something to watch in current-mode logic, but not at the very high speeds. Also, you sacrifice price competitiveness if you try to make TTL do a current-mode logic job."

There are other U.S. computer manufacturers who want ECL speed, and are using it in machines already on the market or well into development. These include, aside from IBM and its 360/85 and 360/195, and its new, small System 3: RCA for the top of the Spectra 70 computer line; Control Data Corp. for the CDC 3500, with the 6600 and 7600 using a discrete form of current-mode logic; and Burroughs Corp. for the controversial Illiac 4, for which TI again is the principal ECL supplier. TI is also believed to be supplying custom ECL for General Electric Co.'s giant new GE 655 computer [*Electronics*, Dec. 8, 1969, p. 34].

Motorola is known to have "firm programs," according to one insider, to provide custom MECL 3 and 4 circuits to Control Data Corp., International Computers Ltd., RCA, and Univac.

ECL is being eyed by instrument manufacturers, who are looking for high-speed counters and frequency

synthesizers, and communications systems manufacturers, who want high-speed digital-to-analog and analog-to-digital converters.

**Communications, too.** Narud says pulse-code modulated communications equipment such as that used in satellite communications is another candidate for ECL.

And Philco-Ford's Luce also points out that ECL's speed will be translated into greater accuracy in the complex coding and error detection and correction required in these systems.

And Narud predicts a trend toward very high speeds in mini-computers, which should help ECL crack that burgeoning market, although many other observers say that day is a little more distant. Narud argues that "there's no sense hooking a slow, educated terminal to a fast central processor as long as data communication can be fast. The [Data General Corp's] Supernova is a good example. It uses a clock cycle equal to that of the CDC 6600 because the manufacturer wanted local processing to be as fast as that in the central processor."

Narud cites non-saturating logic as the principal contributing factor to ECL's speed. Motorola eliminates the need for saturation in the MECL line by using a differential amplifier type of input. The current is switched through two alternate paths—the two legs of the differential amplifier—rather than having the transistors turned on and off, which consumes time.

**Bonuses.** ECL offers other advantages besides speed. The inherent action of the differential amplifier input makes one collector the complement of the other. Either or both of these can drive an emitter-follower output, which are then complements of each other. This means, for example, that the OR/NOR functions can be derived simultaneously.

This simplifies logic design. "You can't get these complementary signals out simultaneously with any other logic," Narud says.

With ECL, Narud continues, one can generate numerous complex functions with the same power supply using a logic-tree structure—such functions as AND/NAND, exclusive-OR's, and master-slave flip-flops. He thinks the tree structure





# ERIE

When you want radar as pure and coherent as a laser beam...

Symbolic electronic signal undistorted by EMI —  
photographed by Howard Sochurek

## bring ERIE in early.

31,000 feet...heavy traffic...ugly weather over the Plains. This isn't the time for "noise" in the radar. But, no sweat! RCA's exciting new AVQ-30X Weather Radar is up front, sweeping the sky...protected from EMI by 39 special ERIE filters. No other airborne radar has ever approached the single or dual system reliability of the AVQ-30. From the start, RCA has called on the outstanding research and component capability of ERIE TECHNOLOGICAL to help in the development of this great new unit. Proof, once again, that it pays to bring ERIE in early.

**ERIE TECHNOLOGICAL PRODUCTS, INC.**

644 West 12th Street, Erie, Pennsylvania 16512  
(814) 456-8592

Circle 127 on reader service card



# Now! A smaller\* Digivac S/G<sup>T.M.</sup> display with important new features

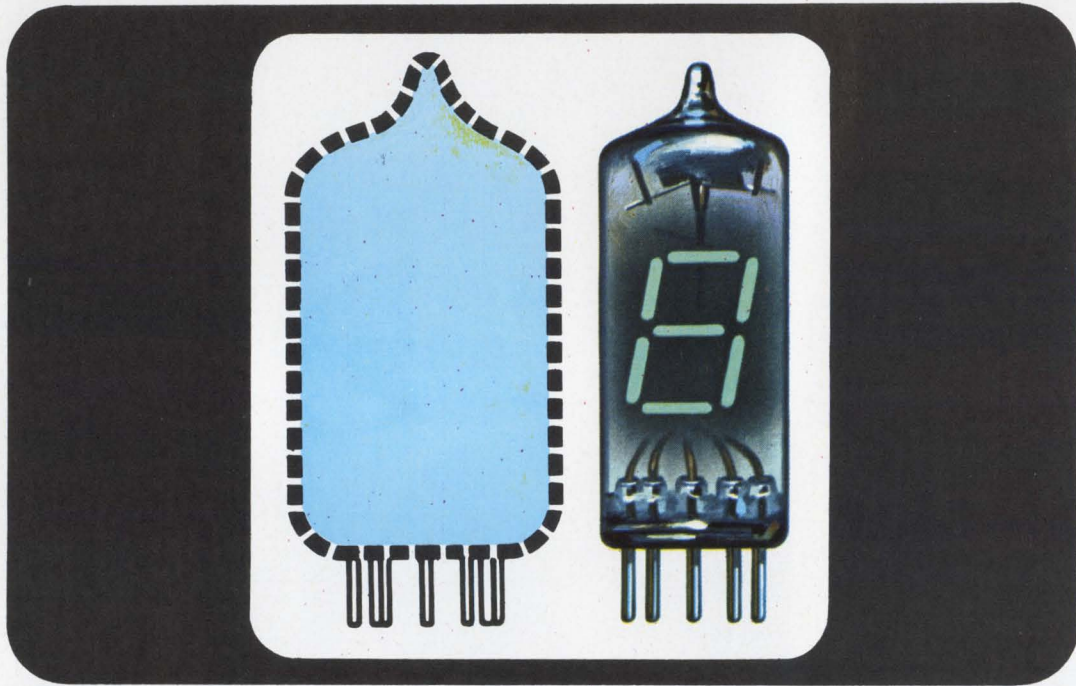

NEW—Requires less space.....NEW—MIL spec construction...  
NEW—Electrostatically stable.....NEW—Solderable leads optional

Electrically and optically identical to and interchangeable with the original types... but substantially smaller. Same driver and low power requirements. Rugged construction meets MIL specs for shock and vibration. Impervious to electrostatic influences. No reduction in size of the single-plane, high-legibility, 7-segment character. Eye-ease green can be filtered to provide unlimited colors. Regular 9-pin miniature basing, or 10-pins where decimal is required. Solder-in leads reduce seated height of Digivac S/G displays.

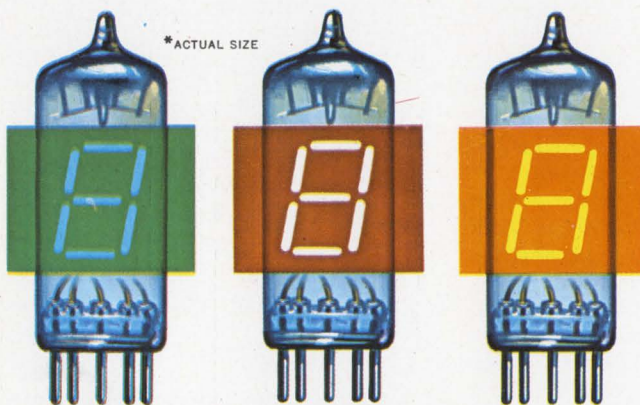

FILTERING PROVIDES COLOR OPTIONS

## DIGIVAC S/G<sup>T.M.</sup>

VACUUM FLUORESCENT DISPLAY

**TUNG-SOL DIVISION**  
**WAGNER ELECTRIC CORPORATION**

630 W. Mt. Pleasant Avenue  
Livingston, N.J. 07039  
TWX: 710-994-4865  
Phone: (201) 992-1100; (212) 732-5426

Trademark TUNG-SOL Reg. U.S. Pat. Off.  
and Marcas Registradas



with three levels of logic can generate memory functions, J-K flip-flops and master-slave flip-flops "very simply, and a 500-Mhz type flip-flop is a reality today. And I can see a toggle frequency of 1 gigahertz-plus in R&D in one year."

Most manufacturers and users like the availability of complementary outputs as a way to achieve greater logic flexibility and lower the "can count" in a system. TI's McFarland says this feature allows the designer to get as many logic functions with 40 less gates than with TTL. This is a really strong feature of ECL. But "secondary to speed," he notes Motorola's Heinrich likes ECL flexibility for the same reason. By having both OR and NOR outputs available at the same time, he says, you can cut the can count in a system because you don't have to add inverters to get one or the other function. Heinrich also likes ECL's greater fan-out possibilities. "You may want to drive as many as 25 gates from one gate; you can do it with ECL."

"Current-mode logic provides more functions per gate," says Advanced Memory Systems' Berding, allowing more functions in a single building block. AMS obtained good evidence of this in designing and building an IC tester. It was designed two ways—one using current-mode logic and one using TTL. The current-mode logic version cost one-third less than the TTL unit.

**The other side.** No technology is without its tradeoffs, however, and there are limitations and problems with ECL, too. Heat dissipation at such high speeds is a problem. And because the family's logic swings are less than those in TTL or diode-transistor logic, Motorola's Richard Abraham, director of advanced IC program, says ECL has smaller noise margins than the other two families, particularly at either end of the military temperature range—800 millivolts for series 54/74 vs. about 200 mv for ECL. Many manufacturers are finding ways around these problems, however, and users aren't deterred by the limitations because speed and logic flexibility heavily outweigh them.

For example, Plessey's ECL used in International Computers Ltd. 1906A computer includes a patented temperature-compensation feature. An extra transistor is con-

nected to the load resistor of the emitter-coupled switch, bleeding off just enough current through the resistor to compensate for the change in temperature of the emitter-follower base-emitter voltage. The chip is said to maintain constant logic levels from  $-20^{\circ}\text{C}$  to  $+80^{\circ}\text{C}$  vs. conventional ECL, which changes logic levels by about 2 mv of chip temperature.

The thermal problems associated with ECL's speeds have yet to be solved simply. Motorola's Callahan says the most difficult thermal problems with MECL are at the package level. Motorola has a package with a stud mounted to it to drain off heat to a combination voltage plane and cold plate.

TI's McFarland says "We don't have a good answer to heat problem. We're working on a waffle package for a customer and we're designing the bar (chip) and package together."

Callahan says Motorola will have a beryllia-based 16-in flatpack to lower thermal resistance out before midyear, but admits that when graduating to 40 to 60 leads on a package, the thermal dissipation problems are compounded. Motorola also has samples of a 40-pin flatpack that has a thermal resistance of  $20^{\circ}\text{C}$  per watt, with air flowing over it at 500 cubic feet per minute.

**Extra care.** TI's McFarland probably best sums up the special considerations in working with ECL. "ECL," he says, "requires a higher degree of sophistication—in printed-circuit board design, thermal/mechanical design, and in designing to minimize noise, but the main problem is in getting people to accept this."

International Computers Ltd.'s Reg Allmark, a technical manager, adds that the extra care required for ECL doesn't have to be a disadvantage. In fact, he says, it can lead to advantages compared to working with TTL. Loadings have to be more carefully controlled and interconnections more carefully matched, but Allmark says that if this is properly done, the performance of ECL logic arrays is more consistent from one to another, particularly in respect to cross-talk and ringing.

ECL manufacturers aren't in complete agreement about the ease of

graduating to MSI and LSI, mainly because of the need to get the increased heat away from the device as the gate count rises. TI is building custom chips with about 20 gates per chip. McFarland reports that 20 to 30 gates on a device are producible in volume, "and we may go to 50 gates next year, but beyond that, there are severe problems."

But the firms exhibiting the better speed-power products—Motorola and Philco-Ford—are talking less conservatively. Callahan of Motorola says that for sub-nsec speeds at 50 mw per gate dissipation (MECL3) the complexity is limited to about 50 gates, but with MECL 4, if the speed is backed off to 1 nsec at a dissipation of 10 mw per gate, device makers may be able to go to 150 gates. "But this dictates some thermal considerations for the systems people that aren't clearly defined yet."

Philco-Ford's Luce says that ECL technology has been hamstrung by high power dissipation. This is because of the need to connect circuits of low complexity by coaxial cable to preserve speed. And coaxial demands power-drive capability. Luce says the solution is more complex chips, such as the one with 100 gates and three levels of metalization. He argues that if you're just driving the next gate on the same chip, the power required is greatly reduced if device geometries are small and interconnections are designed for low capacitance—as in ECL designs.

Because ECL devices at those speeds are so new and few, and mostly custom designs, their makers are hesitant to quote hard price figures. TI sources feel the cost per gate will be higher than for saturated logic, even after volume production begins. Of course, there are standard products available—in TI's ECL 2500 family at 50 cents to \$1 per gate, and Motorola offers a variety of standard functions in MECL 1, 2, and 3. Callahan sees no reason why ECL should be competing head-to-head with TTL at any time soon, if ever. Nor do many of his colleagues. "If one is smart," he says, "one won't let them be competitive. We won't design MECL 3 at 10 Mhz, for example, because it wouldn't ever compete with TTL at those speeds."



# INTEL BOMBS THE PRICES ON LSI MEMORIES

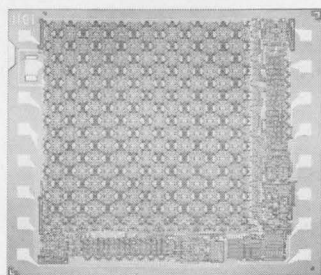

**Model 1101**, a 256-bit MOS RAM with 1.5  $\mu$ sec maximum access, drops in price by 60% to 73%. Now competes in price with small core memories.

## Industry prices cut more than half

Very high yields at Intel are beginning to realize the long-promised economies of LSI. Using advanced technologies — like the silicon gate for MOS and the Schottky process for bipolars—Intel has achieved yields far greater than the 2% or 3% typical of LSI production.

First major price reductions have been made on two fully-decoded random-access memories, both DTL and TTL compatible. Look at the difference between old and new prices:

Quantity	Model 1101 (256-bit MOS)	Model 3101 (64-bit bipolar)	Both New
	Old	Old	
1 - 9	\$150	\$99.50	\$40.00
10 - 24	\$110	\$74.00	\$40.00
25 - 99	\$ 80	\$53.00	\$32.50
100 - 249	\$ 65	\$43.00	\$26.50
250 - 999	—	—	\$26.50
1000 - 2000	—	—	\$23.50

**In stock now at over 40 locations.** Phone your local Intel distributor: Cramer Electronics or Hamilton Electro Sales. Or call us collect at (415) 961-8080. Intel Corporation is in production at 365 Middlefield Rd., Mountain View, Calif. 94040.

**Intel delivers.  
Try us.**

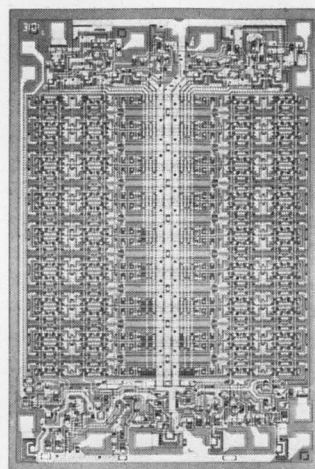

**Model 3101**, a 64-bit bipolar RAM with 60 ns maximum access, drops in price by 38% to 60%.

**intel**<sup>TM</sup>



# Unmanned flight: NASA economy model

To get the most mileage from a tight budget, space agency is counting on unmanned planetary missions to yield the broadest range of data

By Ralph Selph

*Electronics* staff

After a decade of highly successful manned space flights, capped by the glittering achievements of the Apollo moon landings, NASA is placing a new emphasis on unmanned planetary explorations. Impetus for this new direction, which marks the end of single-goal missions, is both scientific and economic.

Funding for unmanned planetary exploration is still small in terms of the space agency's proposed \$3.3 billion budget for fiscal 1971. But at \$144.9 million it still represents a higher percentage, 4.4%, than ever before. The budget for planetary flights rose to \$151 million in fiscal 1970 from \$87.9 million the previous year, but will drop to the \$144.9 million figure for fiscal 1971.

Five years ago the Federal government's Space Sciences Board outlined basic goals for gaining a better comprehension of earth and the origin of life and the solar system through comparative studies of other planets. In 1969, these goals were reappraised. And in light of severe cuts in the NASA budget, unmanned planetary programs, were particularly recommended because they could contribute to a broad range of scientific disciplines.

According to Donald P. Hearth, director of NASA's planetary program, the board looked at several basic strategies and concluded that a balanced approach—one between a detailed exploration of one planet at a time and simultaneous exploratory measurements of as much as possible of the entire solar system—would be best for investigat-

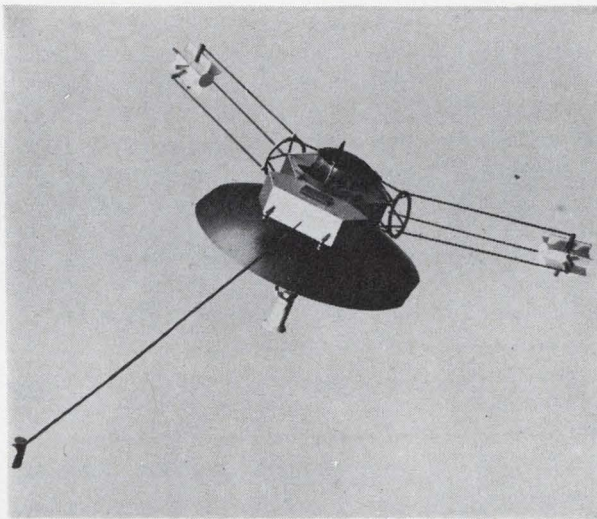

By Jupiter. Pioneer F&G to be launched on Jupiter flybys in 1972 and 1973, will be the first inter-planetary craft to rely on radioisotope thermoelectric generators, mounted in this model on the two shorter booms. The third boom on the 500-lb TRW spacecraft holds a magnetometer.

ing the reaches of the solar system.

Despite its smaller total budget NASA planetary exploration goals for the next five years are substantial. They include orbiting and landing on Mars, flying close to the sun and getting the first close look at Mercury and Venus, and going beyond Mars through the asteroid belt to Jupiter.

There are some minuses, too. The agency failed to obtain fiscal 1971 funding that would begin the design of a combined orbiter and atmospheric probe launcher for exploring Venus. Launching was to have been in 1975. And 1972 funding for a "Grand Tour" flyby of the outer planets in 1977 or 1979 is still uncertain. One effect of fiscal 1971 budget cuts on already scheduled planetary programs is slippage of the Mars Viking orbiter-lander launch from 1973 to 1975. NASA officials say the delay, including runout costs and inflation, could increase ulti-

mate costs by as much as \$150 million.

The next planetary mission will begin May 1971, when two Mariner Mars spacecraft are launched eight to 10 days apart toward a 90-day orbital mission around Mars. Each spacecraft will have a distinct mission. One craft will be placed in a 60° inclined elliptical orbit (1,000-10,500 miles) in a 12-hour orbital period. This orbit will permit maximum data return as the planet slowly rotates beneath each orbit, allowing the craft to map about 70% of the planet's surface during the 90-day mission.

The second craft will be inserted into a 32.8-hour orbit that's inclined 50° to 80°, permitting the spacecraft to view the same surface areas every fourth orbit.

Experiment instruments essentially will be the same as those aboard Mariner 69, except that an infrared spectrometer used in the earlier mission to identify gases in



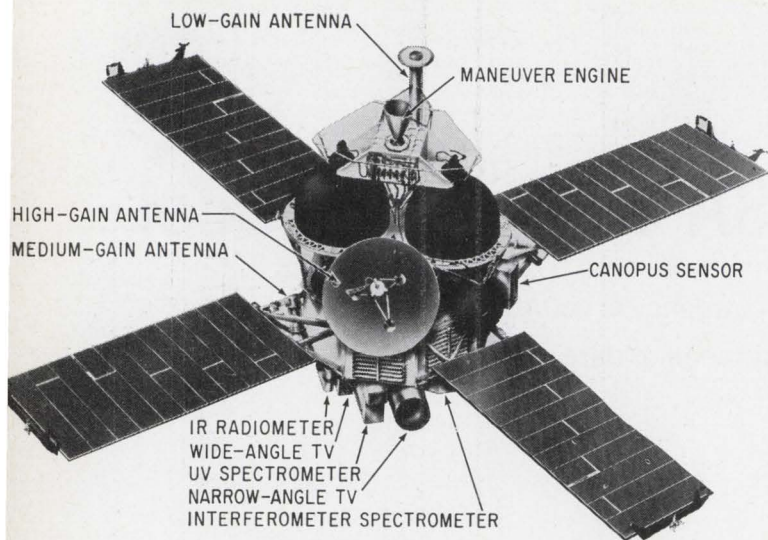

**Mars again.** Two Mariners will arrive at Mars in November 1971 and orbit the planet for 90 days. Scientific instruments will be able to sweep about 70% of the surface, and some photographs will be taken as close as 1,000 miles.

the lower atmosphere will be replaced with an infrared interferometer-spectrometer that operates in the 6- to 22-micron band and gives a higher resolution spectrum. Other instruments will include an ultraviolet spectrometer (1,100-to-3,400-angstrom range); and a two-channel i-r radiometer (8-to-12 and 18-to-25 microns).

Visual imaging will be similar to what was done on Mariner 69, with both wide- and narrow-angle television cameras. The wide-angle camera will look through a red, green, and blue color-filter wheel, with each color selectable from earth. The cameras will have 700 by 900 lines resolution. A wider range of gray scales will be transmitted than was on Mariner 69. This will be done by going from 8-bit to 9-bit words for each picture element. Surface resolution at the lowest orbital point will be 0.6 to 12 miles for the wide-angle camera, and 0.06 to 1.2 miles for the narrow-angle camera.

The spacecraft's high-gain 25-decibel antenna has two positions to accommodate changing angles between the antenna and earth during the mission. During the early portion of the mission, communications with the spacecraft will be through a low-gain 7.3-db omnidirectional antenna.

**Data ranging.** Because of the changing range between earth and Mars during the mission, tv transmission rates will be variable from 16.2 kilobits per second down to 1 kilobit per second. Three 85-foot-diameter deep space network antennas will provide backup for the 210-foot antenna at Goldstone,

Calif., during the mission. Fifty-four days after the spacecraft go into orbit, tv playback rates will drop to 8.1 kilobits/sec. After 90 days, at a communication range of about 150 million miles, the rate probably will drop to 4 kilobits/sec. By that time, a tv image will require about 20 minutes for playback to the Goldstone antenna, compared with about five minutes earlier in the mission.

Complex circuitry associated with analog recorders used in earlier Mariners has been eliminated through a single digital recorder, with a considerable improvement in reliability, according to Robert Forney, JPL's spacecraft system manager for the project.

Forney says the timing, gating, and control circuits previously distributed among the tv, data automation and data storage systems also have been simplified and con-

solidated. Much of the circuitry has been placed in the data automation system, which now has a small core memory that permits it to encode the time that science data is taken. Unlike Mariner 69, where operation sequences were controlled through planet-in-view and data signals, control is under a central computer and sequencer programmed from earth. Improved flexibility is reflected in a 512-word sequencer memory which is four times larger than the one used in Mariner 69. Mariner officials hope that both 1971 craft will send back data for at least a year.

In February or March 1972, NASA will launch Pioneer F on a Jupiter flyby mission that will be a keystone in future Grand-Tour missions to the outer planets. A second spacecraft, Pioneer G, will be launched in April 1973 on the same two-year journey.

Mission objectives include measurement of the interplanetary environment, assessing the spacecraft's ability to survive the asteroid belts, and learning about Jupiter's atmosphere through measurements in the infrared and ultraviolet. Information on the planet's radiation belts also will be returned, as well as pictures of the surface from 100,000 miles, the closest approach.

Although the Pioneer F and G spacecraft will be small (weighing only about 530 pounds), each will carry 11 experiments with a total weight of 60 lbs. NASA official Robert S. Kraemer says a spin-scan camera on the craft will be able to take pictures of Jupiter at least four times better than the

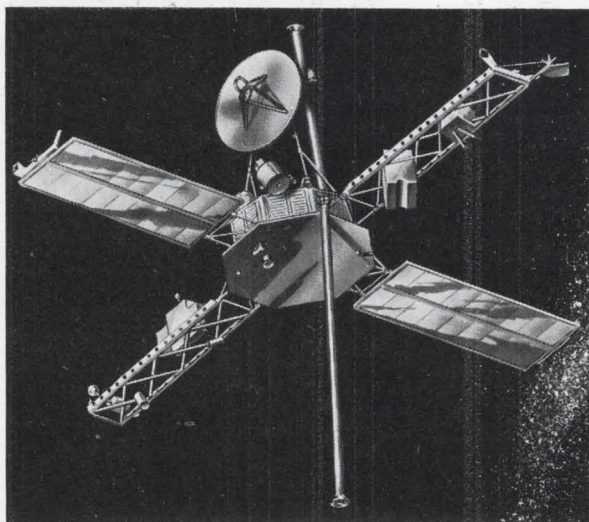

**Tilt.** Artist's concept of spacecraft for Venus/Mercury mission in 1973 shows two tiltable solar panels, rather than the four fixed panels of previous Mariners. Science payload, which NASA will select in August, occupies 110 of the craft's 850 lbs.



best views astronomers have had from earth-based telescopes.

The two Pioneers also will be the first planetary missions to use radioisotope thermoelectric generators as a primary power source. Four RTC's, modifications of the Snap-19 units used in the Nimbus satellite, will supply 156 watts of electrical power at launch, and 132 watts at Jupiter two years later.

Overall direction of Pioneer is under NASA's Ames Research Center. TRW Systems Group will build the spacecraft, a lineal descendant of Pioneers A through E, under a \$37.6 million contract. The craft will be spin-stabilized with the spin axis oriented toward the earth. A conical scanning system is used to maintain the spin-axis orientation, and a 9-foot-diameter, parabolic, high-gain antenna has a 3-db gain and 3° beamwidth. As a transmitter, the antenna has 33 db gain. A medium-gain horn antenna, still under design, probably will have 3 db gain, and a 25° to 30° beamwidth. Output of the antenna can be combined with that of a low-gain log conical spiral antenna to give an almost spherical scan. Redundant traveling wave tubes will provide 10 watts of transmitting power at launch, and 8 watts at Jupiter.

Using the 210-foot Goldstone antenna, the data transmission rate at Jupiter will be a conservative 512 bits per second, falling to about 32 bits/sec when the 85-ft. ground dishes are being used. Bit rates during the mission will range from 2,048 down to 16, with both experimental and engineering data going into the same modulation stream. The higher 2,048-bit rate is expected to be usable during the first half of the mission.

Experimental data is stored in a 49,000-bit core memory, a considerable increase in capacity over earlier Pioneers, which had only 18,000 bits of storage. A new command memory unit uses bipolar logic IC chips, and has five command sets with eight bits per command. MOSFETS are used heavily in the telemetry unit for multiplexing science information into the bit stream. Pioneer project officials say tape storage units are being considered for future advanced missions but "are a luxury on this mission."

**Venus watcher.** The next foray in NASA's outer-planets venture will be the Mariner Venus-Mercury mission scheduled for launch with an Atlas/Centaur in October 1973. Passing within 3,440 miles of Venus in early February 1974, the spacecraft, using the "slingshot" effect of the planet's gravity, will gain additional velocity and continue on to within 600 miles of Mercury, arriving in late March 1974. The 1973 opportunity is the last possible within this decade using the relatively inexpensive Atlas/Centaur vehicle, although a direct flight to Mercury could be made with a more powerful launch rocket.

The mission's principal goal will be to explore Mercury's environment, atmosphere, and surface, in addition to obtaining atmospheric and environmental data from Venus. It is also expected to yield other interplanetary information and to give operational experience with dual-planet, gravity-assist operations that will be required in future missions.

Experiments and investigatory teams to be assigned to the mission won't be selected by NASA until August 1970. Likely to be included are visual imaging, celestial mechanics, and radio science, as well as plasma science, ultraviolet, infrared and gamma-ray spectrometry, and energetic particle, plasma-wave, and magnetometer experiments. About 110 lbs will be available for experiments on the 850-lb spacecraft, which will weigh about the same as Mariner 69.

Although \$21.1 million has been requested for the project in fiscal 1971, the spacecraft design will feel the effects of NASA budget constraints. The newly appointed project manager, W.E. Giberson of the Jet Propulsion Laboratory, which has primary responsibility for the mission, says the aim is "to try to minimize the cost, with a maximum of science information obtained." The baseline design calls for the heaviest possible use of Mariner 69 and 71 subsystems.

Some subsystem departures from Mariner 71 design have been dictated by the fact that suppliers are no longer producing certain component parts, Giberson says. Major changes will be made in the flight data system (FDS), which will combine the functions of separate sci-

# IT'S WHAT'S INSIDE THAT COUNTS!

**\$3120\***

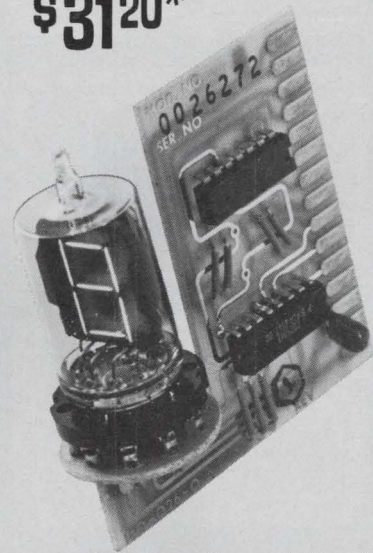

## DM627 DECIMAL COUNTING UNIT

A compact (2.5"H x 2.45"D x .95"W) decimal display with IC decoder/driver and decade counter, the DM627 has TTL and DTL compatible inputs and outputs. BCD counter output and reset input are available externally. Indicator tube is the RCA NUMITRON (7-segment), which provides sign and numerical readout 0 through 9, with decimal point.

Need mounting hardware? The DDP900 Series with 1 to 6 digit bezels and mounting assemblies are available now. Add our 5 volt power supplies and turn on... with economy YOU can count on!

Price: 1-3 \$43.90, \*100 \$31.20

**3 DAY SHIPMENT... CALL TODAY**

Computer Products, Inc.  
P.O. Box 23849  
Fort Lauderdale, Florida 33307  
Phone: 305/933-5561



**COMPUTER  
PRODUCTS™**

FORT LAUDERDALE



# front panel ideas

\*Prices shown are single lot.  
Inquire about quantities.



## Keyboard Switch

A reliable reed switch is actuated by a permanent magnet. Stringent close tolerance maintained in operator pressure and operating points are standard. RSM-41 with plain key cap. **2.70\***

322

## Replaceable Readout!

7-Segment incandescent numeric, 3-5V @ 40-60 ma. Wide angle, built-in filter. With socket. MS-4000BR.

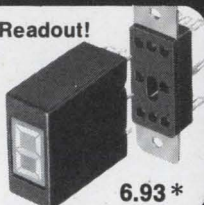

323

**6.93\***

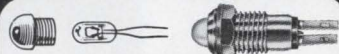

## Replace-a-Lamp Pilot

Miniature lamp assembly utilizes un-based T-1 lamps replaceable from front. Equipped with #680 lamp rated 5V @ 60 ma. Screw lens colors optional. BFK-5. **1.29\***

324

**1.29\***

## Knurled Aluminum Knobs

Machined aluminum anodized to satin finish. Slight conical top and hairline. Natural finish. KD Series: 1/2", 55¢; 1", 70¢.



**55¢\***

**70¢\***

325

## Ceramic Terminal Strips



326

Enhance equipment with high quality ceramic. Simplifies component replacement, provides test points. Long life. Trial Kit, 2 ea. 7 sizes. Snap mounting. (MEP-NB). **10.00 Kit**

## Remote Control Relay

Plugs into 117 VAC outlet and provides "safe" low-voltage remote control. FRE-103.

327



**4.95\***

Immediate Deliveries on Above Items!

# ALCO<sup>®</sup>

ELECTRONIC PRODUCTS, INC.  
Lawrence, Massachusetts 01843

See us at Alco Booth 4G23 IEEE Show

ence data and flight telemetry subsystems in Mariner 71. The FDS will perform onboard computing and sequencing, and science data processing and formatting. The size of the memory in the FDS will depend on the imaging system selected. It will probably contain 256,000 bits for storing science data during earth occultation at Mercury, and for variable engineering format generation. A tape recorder with  $1.8 \times 10^8$  bits of storage will be able to hold about 34 frames of television data. The same central computer and sequencer with 512 words of memory, used in Mariner 71, probably will be employed and there will be only minor modifications to the high-gain antenna.

Both the trajectory to Mercury and cost tradeoffs will have to be considered before an imaging system can be selected, according to Giberson. A simple adaptation of the Mariner 71 camera with new optics, and using the same tape recorder, would be the least expensive option, he says. A second alternative: redesigning the Mariner 71 camera (700 by 900 lines resolution) to a higher-density picture, and modifying the tape recorder for a higher playback speed. Still another possibility would be to use a videotape recorder like that being developed for the Viking orbiter-lander mission to Mars in 1975. "A more costly alternative would be a high-resolution film system like the one used on the lunar orbiter, but more compact, and improved," says Giberson.

Downlink data transmission rates will be greatly increased by using two new 210-foot ground antennas in Australia and Spain along with the 210-foot Goldstone, Calif., unit.

Although theoretically the science data rate from Venus should be about 32 kilobits/sec, design probably will be pointed toward a more conservative 16.2 kilobits/sec, with higher rates conditioned on experience during the mission.

Two Viking Mars orbiter-landers, at 7,000 lbs. the heaviest unmanned spacecraft to be launched, have been deferred by budget cuts from 1973 to August-September 1975 launch dates. They will require the most complex science instrumentation ever developed for an unmanned planetary mission. Scientific objectives for the landers

include return of visual images of the landing site, search for evidence of living organisms, identification of organic compounds, determination of the presence of water, and measurement of the atmospheric composition. Additional readings will be taken on changes in temperature, atmospheric pressure, and wind velocity, ultraviolet radiation, and the seismological nature of the planet.

**Thermal maps.** According to Milton A. Mitz, NASA's Viking program scientist, the three main experiments aboard the orbiter will take "bore sighted" looks at the same point on the planet, visually mapping the surface with a tv camera designed and built by JPL. It also will thermal-map the surface to determine variations in surface temperatures with an infrared radiometer built by Hughes Aircraft's Santa Barbara Research Center.

The two-year delay in the Viking program will be used to further develop the three main multi-million-dollar lander instruments, Mitz says. These are a gas chronometer-mass spectrometer, under development by JPL, and an active biology instrument, which will perform a series of experiments including the detection of photosynthesis, respiration metabolism, and the growth of microorganisms. Both TRW and Bendix are bidding on this instrument. A three-axis seismometer to detect and characterize seismic activity on the planet also is under development. On the minus side, the delayed 1975 launch will not be as opportune as a 1973 launch—the flight to Mars will take about 12 months, compared with seven months if the Viking craft were launched at the earlier date.

Langley Research Center has overall NASA responsibility for Viking. JPL is developing the orbiter and the tracking and ground-based data system, Martin Denver is developing the lander. The Denver division of Martin-Marietta also is responsible for integrating the lander and orbiter into a complete spacecraft. The orbiter will be an extension of Mariner 1971 design, the lander an evolution from the Surveyor soft lunar-landing vehicle. The lander will also have to be sterilized completely at 125°C to avoid carrying microorganisms to Mars. Sterilizable bat-



tery separators must be developed and so must a sterilized tape recorder—a tall order. The latter will be accomplished through one of two approaches: a metallized tape technique advanced by Lockheed Electronics or a Borg-Warner approach using plastic and aluminumized Mylar.

The lander's power system will use two radioisotope thermoelectric generators to supply 50 watts of continuous power, assisted by a rechargeable silver-zinc battery during peak load periods.

Both the lander and orbiter will have S-band communications links with earth. But during descent and for the first three days on Mars, the lander will send its data to the orbiter over a uhf link for relay to earth. After that, the lander will be able to use its S-band link and send data back directly, using a high-gain, 30-inch-diameter parabolic dish, according to H.L. Schwartzberg, Viking program manager at RCA's Astroelectronics division, which is developing the lander's communications system. Stepping motors will steer the dish over two axes to point at earth.

The orbiter's relay capability will be used to get data back to earth faster than could be done directly from the lander. The orbiter also can store imaging data from the lander at a 2- to 4-megahertz rate and relay it back to earth during the following 24 hours. Minimum and maximum data rates from the orbiter to earth haven't been finally established, but science rates may be 2, 4, 9, and 16 kilobits/sec; engineering rates are 8 and 30 bits/sec. Science data from the orbiter will be received by the complete network of three 210-ft-antenna ground stations.

Orbiter antennas may include one or two omnidirectional units and a 58-inch diameter high-gain antenna with 28 db gain. The two omni-antennas, if used, would permit commands to the spacecraft in any attitude. Transmitted power probably will be 20 watts, and two nickel-cadmium batteries with a nominal power capacity of 400 watts will supply power together with 150 square feet of solar cells. Redundant traveling-wave tubes, similar to those made by Hughes for Mariner 69, are likely, according to Viking officials at JPL.

# World's most powerful electronic calculator

## ...awaits your orders



### WANG 700A

The 700A is in production.

It's available to solve a complex scientific, engineering, statistical, or financial problem instantly, whenever you need it. The 700A can execute 960 core stored program steps and manipulate data in 120 registers. It performs + and - functions in 300 microseconds,  $\times$  and  $\div$  in 3 to 5 milliseconds,  $\text{Log}_e X$  and  $e^x$  in 17 to 35 milliseconds and trig functions in 250 milliseconds. And it also loops, branches, does subroutines and makes decisions. These are some of the reasons that have created the unprecedented demand for the Wang 700A. And why we're increasing production to make it available sooner to more people.

Of course, first come; first served.



Dept. 3H, 836 North St., Tewksbury, Massachusetts 01876 • Tel. 617 851-7311

#### Call today!

(201) 272-7160	(301) 821-8212	(404) 633-6327	(513) 771-3445	(615) 889-1408	(717) 236-4782
(203) 288-8481	(303) 364-7361	(405) 524-4489	(515) 288-5991	(615) 266-5055	(717) 675-3879
(205) 881-5360	(305) 563-8458	(413) 734-2230	(516) 437-2500	(616) 458-6595	(801) 487-2551
(206) 525-2000	(309) 673-6620	(414) 442-0160	(518) 785-3234	(616) 454-4212	(802) 223-6398
(212) 736-0084	(312) 297-4323	(415) 692-0584	(601) 875-5588	(617) 542-7160	(805) 962-6112
(213) 776-2985	(313) 352-7112	(502) 897-5143	(602) 274-2110	(702) 322-4692	(808) 536-5359
(214) 361-7156	(314) 997-5866	(503) 297-2501	(603) 669-0404	(703) 595-6777	(813) 872-7347
(215) 642-4321	(315) 463-9770	(504) 729-0581	(607) 722-7616	(703) 359-6320	(816) 444-8388
(301) 588-3711	(401) 421-0710	(505) 255-5775	(608) 255-4411	(704) 372-9660	(915) 565-9927
	(402) 341-6042	(512) 454-4324	(612) 884-7328	(713) 522-1011	(915) 683-3304
		(513) 531-2729	(614) 488-9753	(714) 276-8464	(918) 743-2571
			(615) 524-8648	(716) 328-2510	(918) 747-0018
				(716) 634-5448	(919) 272-5683



# TEC Can Save You 477\* Steps on Your next Display Panel

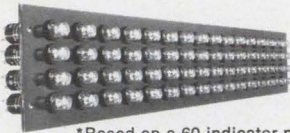

\*Based on a 60 indicator panel.

## To build a conventional panel you'll:

Buy, stock and inspect . . .	60 indicators	Mount . . . .	60 indicators
Punch . . . .	60 panel holes	Wire . . . .	120 terminals
Engrave . . . .	60 legends	Inspect . . .	120 connections
TOTAL STEPS . . . . .		480	

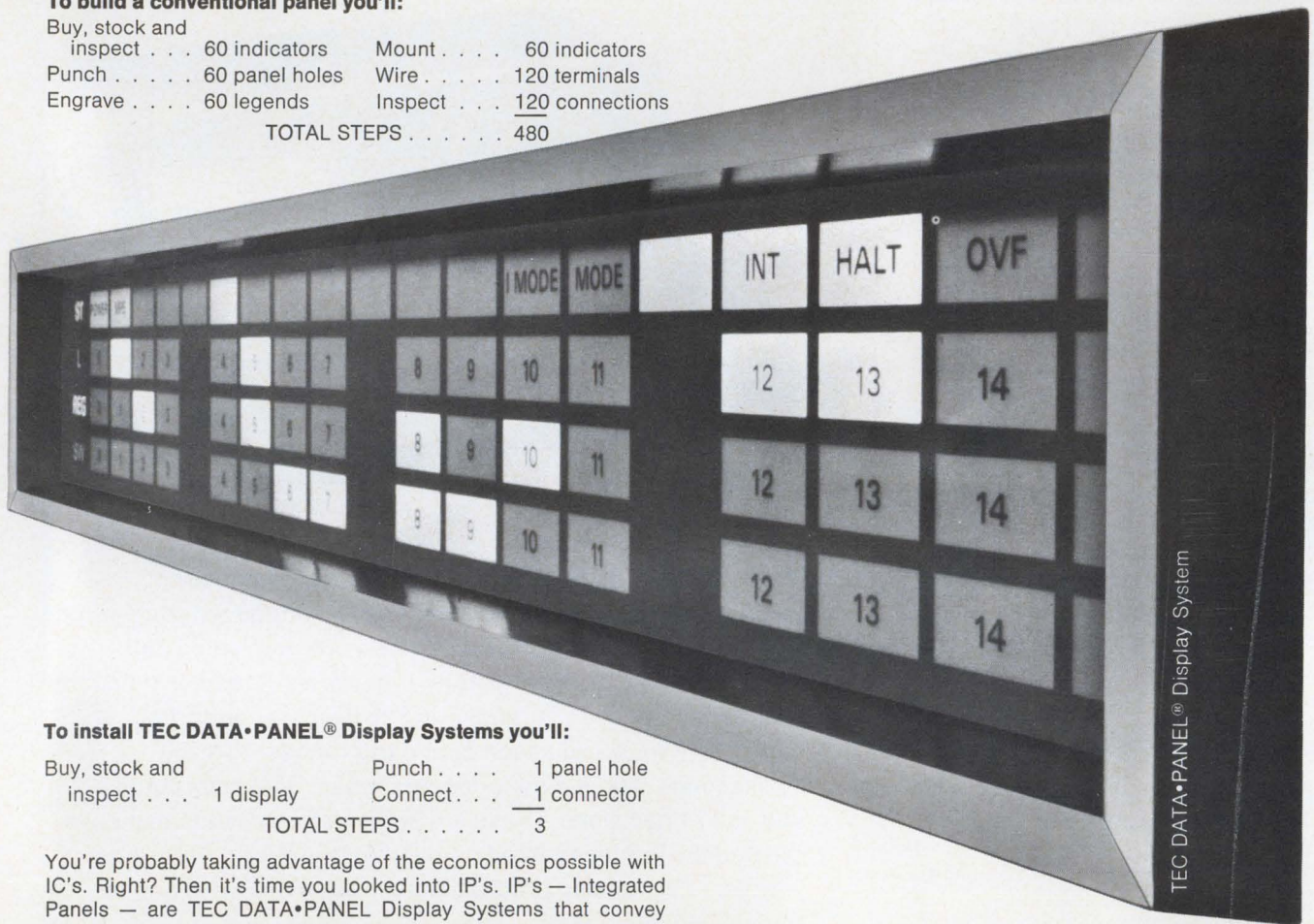

## To install TEC DATA•PANEL® Display Systems you'll:

Buy, stock and inspect . . .	1 display	Punch . . . .	1 panel hole
		Connect . . .	1 connector
TOTAL STEPS . . . . .		3	

You're probably taking advantage of the economics possible with IC's. Right? Then it's time you looked into IP's. IP's — Integrated Panels — are TEC DATA•PANEL Display Systems that convey messages and symbols brilliantly and colorfully in a single viewing plane. Better display, yet costing less per point than individual indicators. And they cut installation work by 50% or more.

DATA•PANEL Display Systems handle any message, any symbol, in any size, in any color. Adaptable to any installation. Flexible. Reliable. Complete. Function as a total input-output system.

TEC is the leading independent supplier of a complete line of display/control products and systems. For information, call: (612) 941-1100. Or write: TEC, Incorporated, 6700 So. Washington Avenue, Eden Prairie, Minnesota 55343.





# IC handler speeds testing

Automatic unit can process 3,600 circuits per hour with 100-msec test time; modular design permits feed system and control technique to be tailored to job

By Stephen Wm. Fields

*Electronics staff*

The semiconductor industry is too involved with electronics and not enough with mechanics—at least where IC handling is concerned. This is the opinion of engineers at the International Production Technology Corp., and they have done something about it with their mini-MIST (modular intermittent sort and test). An integrated circuit handling system, it can be set up for TO-5 cans with 8, 10, or 12 leads; flatpacks with 10 or 14 leads; or dual in-line packages with 14, 16, 24, or 40 leads. Says Charles Bodine, vice president of engineering, “The major effort in IC testing has been related to electronics; little has been done with the mechanical aspects of automatic handling.” According to Bodine, the 24- and 40-pin DIP’s in particular are problems because there is virtually no handling equipment for them, “and they are becoming more widely used throughout the industry with the advent of MSI and LSI circuits.” Moreover, handling is a problem for both the semiconductor manufacturer and the user because of the large amount of incoming inspection that is being done. That’s why the mini-MIST was designed to work with all kinds of test systems.

Bodine cites two categories of test equipment. There are the large computer-controlled systems made by Fairchild, Texas Instruments, and Teradyne; these are used by IC makers and larger customers. In the second category are the smaller, fixed-program testers made by Signetics, Microdyne, and Miracle Hill for incoming inspection.

“With both classes,” Bodine

says, “the limiting factor, in determining how many tests can be performed in a given time, is how the IC’s are presented to the tester. In most cases a girl sitting at the test head plugs the devices in one at a time.”

On the average, about 325 devices can be plugged and unplugged in an hour. This is for a high-speed tester with one test head. But, the same tester is capable of handling from 3,000 to 4,000 units per hour. One solution has been to add another test head and multiplex them; but, Bodine says, for the cost of the multiplex equipment, a mini-MIST system can be added instead. The basic mini-MIST sells for \$4,750 and can handle 3,600 units per hour with

a 100-millisecond test time. By contrast, two multiplexed test heads, with one girl doing the handling, can sample only about 1,000 units per hour.

Even without the obvious advantage of being able to test more devices in less time, the mini-MIST still has it over a girl. For example, when an IC is plugged into a test head by hand, its temperature can be increased. And an increase of 2°C can cause the tester to place the device in the wrong category, or even reject it. Often, with a 14-lead DIP, it’s not hard to be one pin off in inserting the device in a socket.

**Modular.** Designed on a modular scheme, the mini-MIST can be tailored to specific test systems and



**Positive feed.** Finger at right pushes devices toward the test heads at back part of handler. Three output sticks at left hold tested circuits that have been sorted into performance categories.



# NEC's New Digital Indicator Tubes for Desk-Top Calculators and Other Display Devices Offer Triode Construction Plus IC Compatibility

—Stop by the NEC Booth at the IEEE Show and See These Digital Tubes and Other Latest Advances in Electronics

NEC's new digital indicator tubes (DG12E/LD-915 and DG10E/LD-938)—designed for simplified, single-plane display of numerals—offer low-cost as well as low-voltage and low-current advantages. Although their nominal voltage is 20V, they can operate up to 50V for greater brightness. This contrasts sharply with the 200 to 300V usually required by conventional gas-discharge tubes. They are also equipped with an IC driver, making them compatible for use with an integrated circuit mode of operation. Moreover, their triode construction ensures their suitability for pulse operation. Although the typical green color

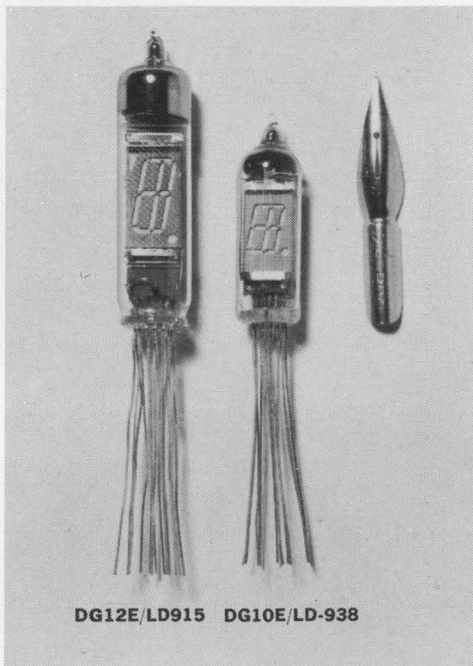

is emitted by the tube display, a variety of viewing colors can be obtained with filters. Besides half-inch-high numbers, DG12E/LD-915 also provides the option of decimal points. Since DG10E/LD-938 is smaller than DG12E/LD-915, it enables the manufacture of still smaller desk-top calculators.

But digital tubes are only one small aspect of NEC's wide-ranging activities. As one of the world's leading manufacturers in telecommunications and electronics, NEC supplies every kind of equipment—from semi-conductors to microwave and satellite communication systems—to many countries around the world.

Electric Specifications	DG12E/LD915	DG10E/LD-938	Mechanical Specifications	DG12E/LD915	DG10E/LD-938
Filament Voltage	0.8V	0.9V	Overall Length of Glass Bulb	53mm Max.	38mm Max.
Filament Current	90mA	100mA	Maximum Diameter	13mm Max.	10.9mm Max.
	DC Pulse	DC Pulse	Shoulder Height	42mm approx.	30mm approx.
Anode (Phosphor Segment) Voltage	20Vdc, 50V	20Vdc, 50V	Weight	7 gr approx.	4 gr approx.
Grid Voltage	20Vdc, 50V	20Vdc, 50V	Mounting Positioning	Any desired position	Any desired position
Anode Current (Sum of All Segment Current)	1mA, 5mA	0.9mA, 3mA			
Grid Current	4mA, 20mA	3mA, 14mA			
Color of Figures	Green	Green			

NEC plans to exhibit a selection of its electronics products, including the digital indicator tubes, at the March IEEE Show in New York (Booth No. 3B-01/02). We look forward to seeing you there.

**LIST OF EXHIBITION GOODS OF IEEE SHOW:** Facsimile Equipment, Paging Receiver, Digital Indicator Tube, Gas Laser, Gunn Oscillator, Photo Transistor, Silicon-Controlled Rectifier, Triggering Device, Neopot, Mechanical Filter, Reed Only Memory, Crystal Oscillator, Microwave Transistor, Microwave Diode, Integrated Circuit, BL Capacitor, Varactor, Reed Switch, Mercury-wetted Contact Switch, Wire Spring Relay, Miniature Relay, Mercury-wetted Contact Relay, Micro Reed Relay.

**NEC New York, Inc.:** Room 3721, Pan American Bldg., 200 Park Avenue, New York, N.Y. 10017 Tel. New York (212) 661-3420 Cable Address: "NIPPELECO NEWYORK" Telex Address: NOPELCO 224936 NEW-YORK

**Chicago Branch Office:** Room 410, 500 North Michigan Avenue, Chicago, Illinois Tel. Chicago (312) 828-9494

**Los Angeles Liaison Office:** Tishman Airport Century Bldg. (TAC-3), 9841 Airport Boulevard, Los Angeles, California, 90045 Tel. (213) 776-5923-4 Cable Address: "NIPPELECO LOS ANGELES CALIF" Telex Address: 9103286574

**Products for today—  
Innovations for tomorrow**

# NEC

Nippon Electric Co., Ltd. Tokyo, Japan

Overseas Offices: Mexico City, Rio de Janeiro, Bogotá, Taipei, Manila, Bangkok, Djakarta, Kuala Lumpur, New Delhi, Karachi, Teheran, Beirut, Melbourne, Düsseldorf.

Main Products: electronic computers, data communication systems, telephone systems, carrier transmission, radio communication, radio & television broadcasting, satellite communications equipment, electrical household appliances, other applied electronic equipment, and electronic components.



yet still be a "standard" product. One set of options is the feed system: the system can be stick-fed, vibratory bowl-fed, or carrier-fed. Bodine points out that no matter what kind of "input" system is employed, the feed is positive, and not gravity-fed. "We have a closed-loop system, where the handler does something and then makes sure that it was done," says Bodine, "so the possibility of jamming is reduced." And, he adds, the operator has the device in full view at all times.

Another option is the control system; it can be either electro-mechanical or fluidic. Bodine says that in linear circuits, for example, "the electrical noise of a relay might ruin the test, so we are offering a fluidic version which eliminates this." The basic fluidic unit costs \$5,250. The output options include either bulk or tube, and three categories are provided.

**Signals.** Electrically the mini-MIST provides a start-of-test signal to the tester; an end-of-test signal is needed from the tester; and a test-category signal is needed from the tester. The test head employs Kelvin wiper contacts, and a Winchester connector is provided for connection to the tester.

Bodine says that the mechanical aspects of integrated-circuit manufacturing and testing are beginning to play a major role because of the importance of yield. Previously, if a few transistors were damaged, it wasn't so bad; but now, if a few \$50 circuits are damaged, then the results are felt by both the maker and the user. For the present, the company is concentrating on handlers for test systems; but, Bodine says, it also has applications in assembly areas and other phases of semiconductor manufacturing.

Bodine came from Sigenetics where he was chief mechanical engineer; Russell Bailey, engineering project manager, was with TI; and the president, Stoney Edwards, was one of the founders and a vice president of Siliconix before he formed the company in June of 1969. IPT has in prototype design a larger system that will handle 8,300 units per hour.

International Production Technology Corp., 185 Evelyn Ave., Mountain View, Calif. 94040 [338]

from **O E I** the  
only COMPLETE LINE of  
CURRENT BOOSTERS

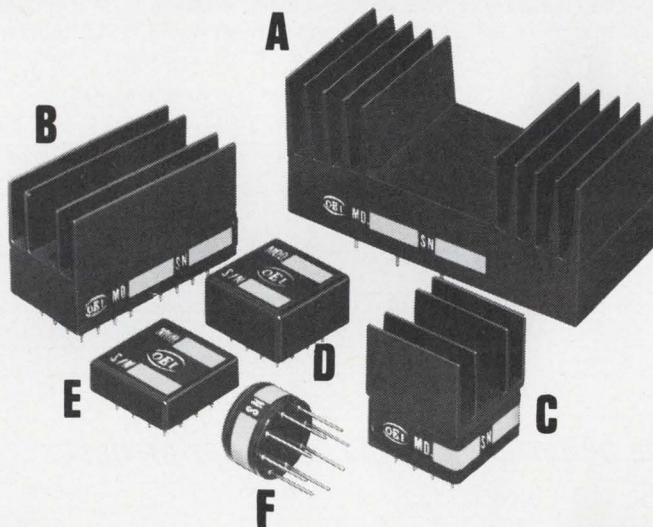

	OUTPUT CURRENT	SLEWING RATE	MODEL	PRICE	
				1-2	100-299
A—	10 AMPS	30V/ $\mu$ Sec	9691	\$135.	\$90.
B—	3 AMPS	100V/ $\mu$ Sec	*9690	93.	63.
C—	1 AMP	300V/ $\mu$ Sec	*9689	71.	48.
D—	0.5 AMP	600V/ $\mu$ Sec	*9682	62.	42.
D—	0.2 AMP	1800V/ $\mu$ Sec	9162A	50.	34.
E—	0.1 AMP	900V/ $\mu$ Sec	*9110B	41.	27.
F—	0.1 AMP	2000V/ $\mu$ Sec	*9510	56.	38.

\*May be used also as a distortion-free unity gain buffer amplifier/follower/cable driver without an operational amplifier.

**LITERALLY ANY OPERATIONAL AMPLIFIER IS COMPATIBLE WITH OEI CURRENT BOOSTERS . . . EVEN YOUR 741!**



**OPTICAL ELECTRONICS INC.**

P. O. BOX 11140

TUCSON, ARIZONA 85706

Phone 602/624-8358



# Second-source 7400 T<sup>2</sup>L with a difference.

We can make immediate deliveries on all these digital devices, but that's not the whole story. These are Philco® 7400 Series T<sup>2</sup>L circuits with Cerdip proved hermetic packaging—the T<sup>2</sup>L package of the future . . . today.

There's more to the story too . . . like the extra glassivation step that protects the circuit against damage, and gives an added measure of reliability; and clamp diode inputs for greater noise immunity and freedom from ringing.

All the items listed are in stock now, with 7 more MSI types due in the immediate future, and 10 more scheduled in the months ahead.

So for immediate deliveries, call on us — we're the reliable alternate source for Series 7400 circuits. Write or call Philco-Ford Corporation, Microelectronics Division, Bipolar Products Marketing, Blue Bell, Pa. 19422. Telephone (215) 646-9100.

DEVICE DESCRIPTION	DEVICE DESCRIPTION	DEVICE DESCRIPTION
PD7400 Quad 2 Input Pos. Nand Gate	PD7440 Dual 4 Input Pos. Nand Buffer	PD7472 JK Master Slave Flip-Flop
PD7401 Quad 2 Input Pos. Nand Gate with Open Collector Output	PD7450 Expandable Dual 2 Wide 2 Input And-Or-Invert Gate	PD7473 Dual JK Master Slave Flip-Flop
PD7402 Quad 2 Input Pos. NOR Gate	PD7451 Dual 2 Wide Input And-Or-Invert Gate	PD7474 Dual D Type Edge Triggered Flip-Flop
PD7404 Hex Inverter	PD7453 Expandable 4 Wide 2 Input And-Or-Invert Gate	PD7475 Quad Bistable Latch
PD7405 Hex Inverter with Open Collector Output	PD7454 4 Wide 2 Input And-Or-Invert Gate	PD7476 Dual JK Master Slave Flip-Flop with Preset and Clear
PD7410 Triple 3 Input Pos. NOR Gate	PD7460 Dual 4 Input Expander	PD7482 2 Bit Binary Full Adder
PD7420 Dual 4 Input Pos. Nand Gate	PD7470 JK Flip-Flop	PD7483 4 Bit Binary Full Adder
PD7430 8 Input Pos. Nand Gate		PD7491A 8 Bit Shift Register

*The better idea people in bipolar products.*

**PHILCO** 

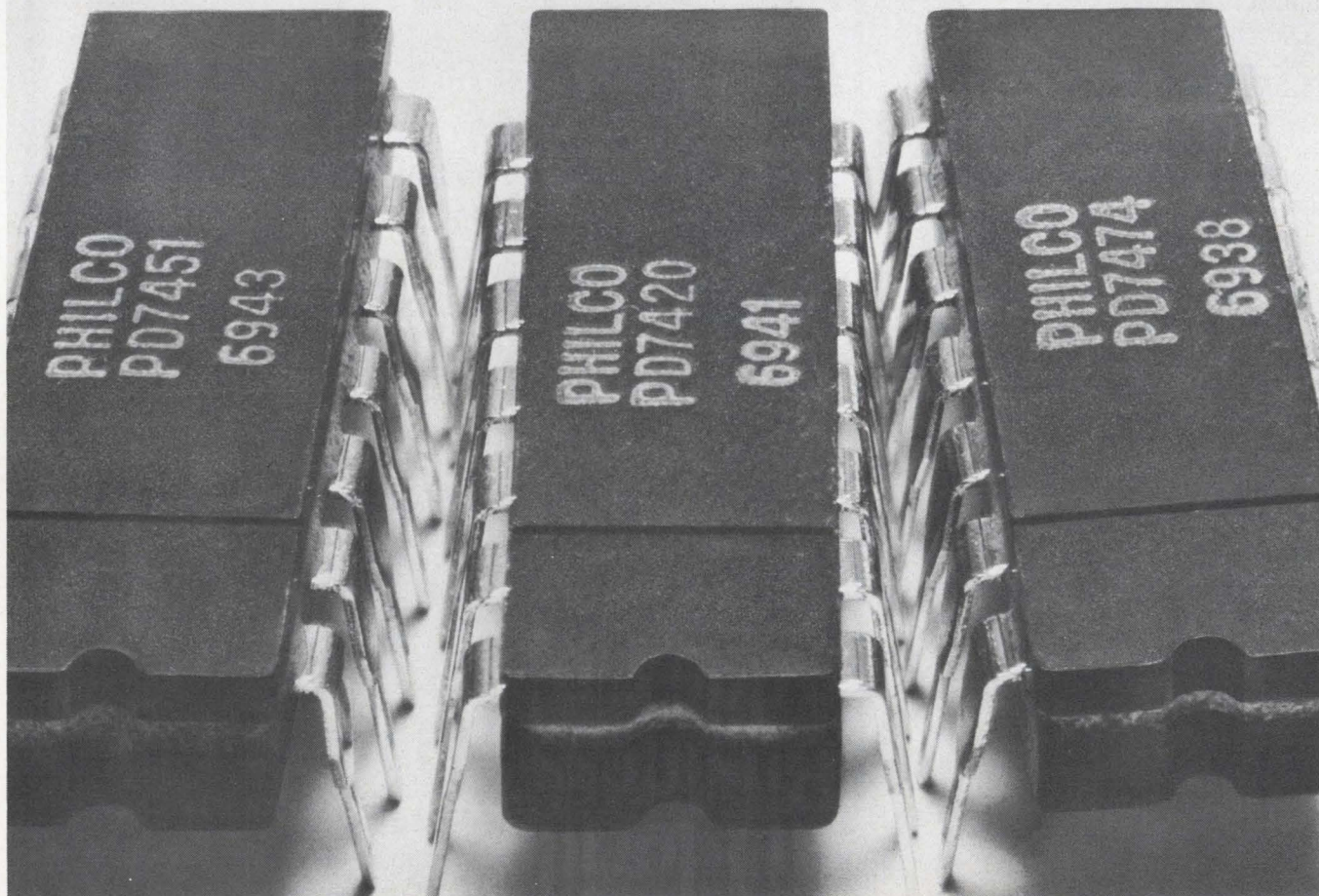



# IC is building block for d-a converters

Switching circuit with high-beta npn transistors designed for use with four-bit resistor network

**A monolithic switching** circuit announced this week by Analog Devices Inc. will be the building block for a line of digital-to-analog and a-d converters to be marketed during the next year by the Massachusetts company's Pastoriza division.

The IC, which was described in February at the International Solid State Circuits Conference, is a four-bit unit and is intended to be used

with a companion four-bit resistor network to form a d-a converter such as the one shown on page 142, in which three packages of four bits are used to form a 12-bit device. For a 12-bit unit like this, worst-case specifications are given as  $\pm 0.012\%$  ( $+\frac{1}{2}$  least significant bit) accuracy, 600-nanosecond switch speed, and 150-milliwatts power dissipation over the  $-55^\circ$

to  $125^\circ\text{C}$  temperature range. The monolithic switching circuit is functionally similar to Fairchild Semiconductor's  $\mu\text{A}722$ , a 10-bit current source.

Analog says the design takes advantage of the monolithic process to provide high-beta npn transistors with inherent matching characteristics. It is based on the design of the Minidac d-a converter that

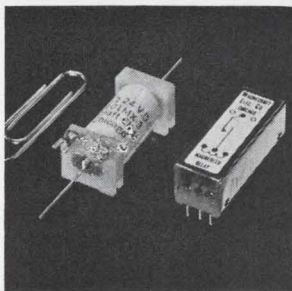

Reed relays for 5-v logic systems are available in two package styles: p-c mounting and in-line axial leads. The spst normally open class 101 has a contact rating of 10 va at 0.5 amp max. or 100 v d-c max. resistive load. Spdt class 104's contact rating is 3 va at 0.25 amp max. or 28 v d-c max. resistive load. Magnecraft Electric Co., 5575 North Lynch Ave., Chicago 60630 [341]

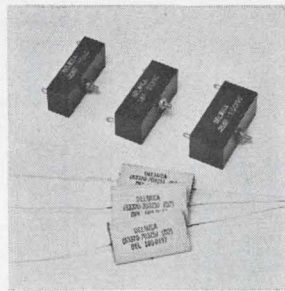

Delmica capacitors offer excellent dielectric characteristics, low positive temperature coefficient of capacitance, low dissipation factor, high insulation resistance, low dielectric absorption, low residual charge, high corona voltage and capacitance stability with time and temperature. Units operate to  $150^\circ\text{C}$ . Del Electronics Corp., 250 E. Sandford Blvd., Mt. Vernon, N.Y. 10550 [342]

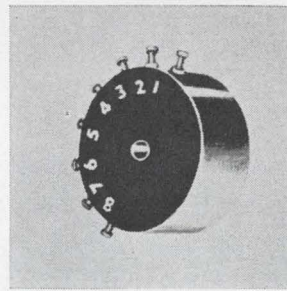

Compact d-c/d-c converter transformers operate at a frequency of 20 khz. Transformer size is  $1\frac{1}{4}$  in. x  $\frac{3}{4}$  in. Units are epoxy molded; weight, approximately 1 oz. Designed for 13.8 or 28 v d-c input, units provide  $\pm 15$  or 30 v output at 1 amp. They are power rated at 30 va. The 100 piece quantity price is approximately \$12. Microtran Co., 145 E. Mineola Ave., Valley Stream, N.Y. 11582 [343]

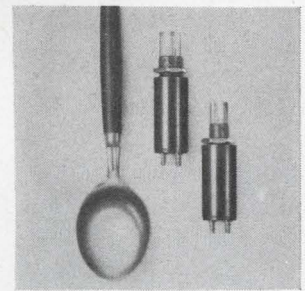

Miniature transistorized Logilite provides a neon glow presentation operating from a low voltage supply source. Normal operating voltage is 5 v d-c, and normal current is 30 ma. Maximum range is 6 v at 36 ma, minimum range is 4 v at 21 ma. Bushing length is  $\frac{3}{8}$  in. Mounting hole is  $\frac{3}{8}$  to  $15/32$  in. Alcolite Division, Alco Electronic Products Inc., Lawrence, Mass. 01842 [344]

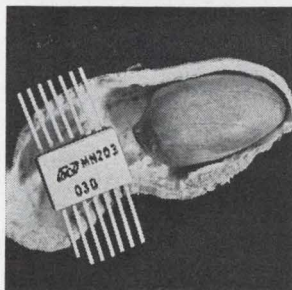

Negative reference ladder switch MN203 is a pair of single pole, double throw switches designed to drive R/2R ladder networks for digital-to-analog circuitry. The unit features a low offset voltage of 2 mv maximum and low series resistance of 20 ohms maximum. It is packaged in a  $\frac{1}{4}$  x  $\frac{3}{8}$  in. flatpack. Micro Networks Corp., 5 Barbara Lane, Worcester, Mass. 01604 [345]



High-pressure biscuit blower is designed for packaging within the confines of equipment having a vertical profile of no more than  $1\frac{3}{4}$  in. It delivers up to 25 cfm free delivery. Applications include computer terminals, core memories, heat exchangers and sinks, power supplies, projector lamps and rack mounted instruments. Rotron Inc., Hasbrouck Lane, Woodstock, N.Y. [346]

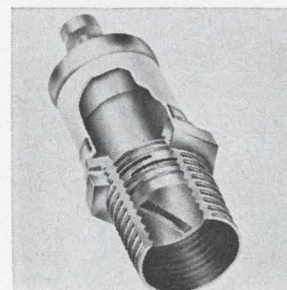

Air trimmer capacitors feature a drive mechanism that has increased their Q by a factor of two over other standard air units. Typical readings are 5,000 at 10 pf and 10,000 at 3.5 pf. Units offer self resonant frequency above 6 Ghz and low dynamic noise during adjustment. Temperature stability is essentially zero. Johanson Mfg. Corp., 400 Rockaway Valley Rd., Boonton, N.J. [347]

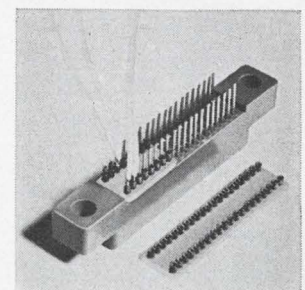

Simple and practical Termi-Aid assists in terminating wires to high-density connectors. It is suited for connectors with contact terminals on 0.050 centers or less. Termi-Aid consists of a fiber glass base,  $1/32$  in. thick, which houses a row or rows of precisely aligned tubes. Price is \$2.95 for 20-tube devices in lots of 500. Swiss Industries, College St., Costa Mesa, Calif. [348]





# INDIANAPOLIS IS INTERSTATE

- Seven Interstate highways converge on Indianapolis to give you more limited access highways to more major market areas than any other city in the U.S. In addition, 12 U.S. highways are linked to the Interstates via circum-urban 465. An abundance of planned plant sites and developments adjacent to the 465 loop put you within 30 minutes of any other part of the city.

- In Indianapolis, over 100 established motor truck lines offer shippers first morning delivery to cities within a 300-mile radius, including Chicago, Detroit, Louisville and St. Louis, second morning delivery to cities within a 600-mile radius, and third morning delivery to cities within a 1,000-mile radius.

- For complete information and assistance on sites, buildings and other data, including computerized site selection services, write **John Hardy, Area Development Director**, Dept. H209 or call collect 317 635-6868.

INDIANAPOLIS *Power & Light* COMPANY

INDIANAPOLIS, INDIANA 46206

has been marketed by Analog Devices for more than a year [*Electronics*, March 17, 1969, p. 169]. The Minidac used high-beta pnp transistors for switching. In the new family of converters, to be known as the  $\mu$ dac series, the monolithic circuit will use npn transistor-current switching, with lateral pnp transistors for shifting logic levels from positive transistor-transistor-logic and diode-transistor-logic levels to the negative npn range.

The four-bit resistor networks use Nichrome rather than the usual tantalum nitride, to achieve a lower

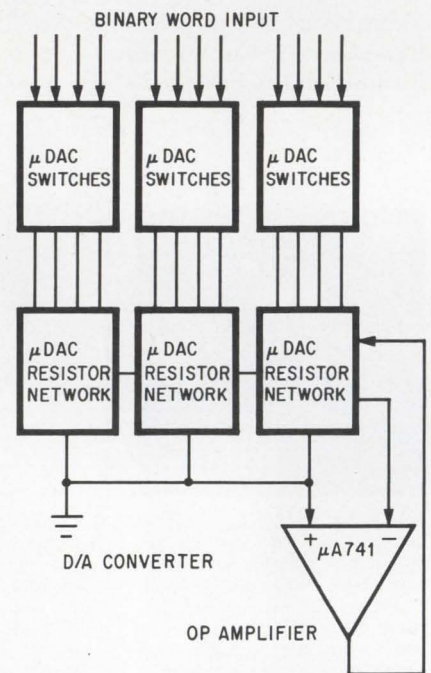

**Modular.** The basic 4-bit switch and 4-bit resistors are used in multiples of 3 to get a 12-bit d-a converter.

temperature coefficient. For applications where extra-high resolution is required, the resistor network can be specially trimmed to match a companion switching network; but for most applications the matching is good enough without any special procedures.

The switching-circuit chip was chosen with a view to accommodating four switches, thus making it compatible with both flatpack and dual in-line packages and providing a partitioning scheme that will assure high production yields.

Analog Devices Inc., 221 Fifth Street, Cambridge, Mass. 02142 [349]



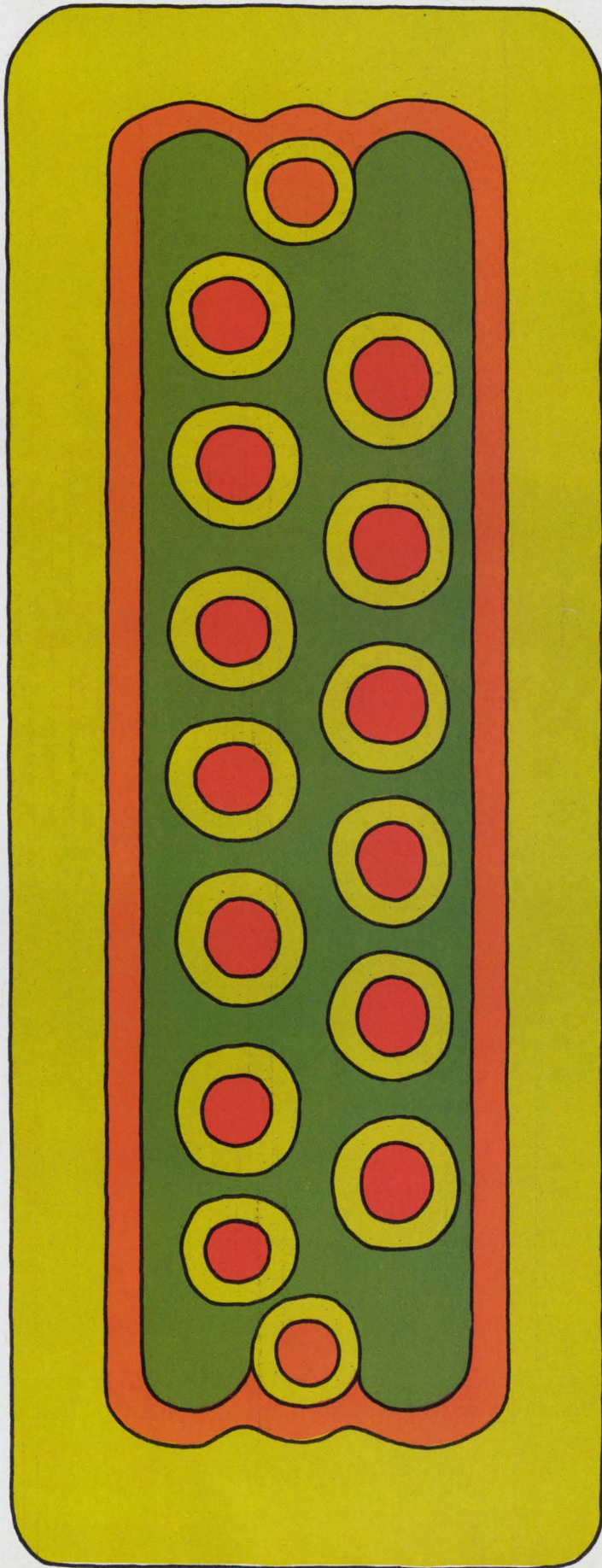

# Winchester Electronics

the  
innovative thinking  
needed to solve  
today's  
problems.

Looking for a quick solution to a particularly knotty connector problem? Look to Winchester Electronics first.

We've got a reputation for producing answers to problems before they exist. So there's always a chance yours might not be a problem after all. For example, we produced our MRE series of miniature rectangular connectors before any specs existed. They've since become the standard for mil spec MIL-C008384. Our MRAC crimp-contact connectors set the standard for MIL-C-22857.

So you see, it's a good idea to contact Winchester Electronics first before you call a problem a problem. With our pioneering spirit, we may have solved your problem years ago. To find out, write or call Winchester Electronics, Main Street and Hillside Avenue, Oakville, Conn. 06779.

 **WINCHESTER  
ELECTRONICS**  
DIVISION OF LITTON INDUSTRIES

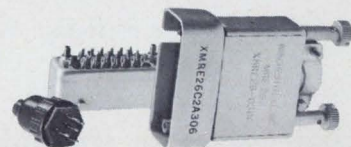





# For less than 1¢ per bit you can stop being a 'wait' watcher.

The largest semiconductor memory in the world will block transfer up to 16 megabytes per second, access in microseconds and store up to 128 megabytes per selector channel for less than 1¢ per bit.

Meet the SSU :

1. System/360 compatibility
2. 30 to 60 times faster access than high-speed drums
3. Data rate synchronized to the CPU
4. No software changes required for attachment
5. No overrun. The SSU's exceptional transfer rate can be stopped instantly for interrupts
6. 10 times faster I/O request handling than high-speed drums
7. Twice the terminal servicing capability
8. 100% usable storage; no record gaps

The SSU with its capacity to store operating systems, application programs and compilers will increase your throughput, upgrade your present installation to fourth generation performance, and extend the life of your system.

To find out how, write us today. Why wait?



# Multimeter puts the emphasis on multi-

With autoranging for all settings, this 5½-digit instrument measures a-c and d-c voltages, ratios, and resistance

**Engineers will line up** to use an instrument that's versatile, accurate—and so expensive that each man cannot have his own. The 6853 digital multimeter from the Cimron division of Lear Siegler Inc., is that kind of instrument. Priced at \$6,010 with all options, it's too expensive for most firms to be able to buy one for each of its engineers. On the other hand, it is so versatile and

accurate that just about every engineer in a laboratory will find a use for it.

A 5½-digit instrument, the 6853 measures voltage, be it a-c or d-c; voltage ratio, be it a-c/a-c, d-c/d-c, a-c/d-c, or d-c/a-c; and resistance, from 1 ohm to 100 megohms.

For any of these measurements the multimeter autoranges, and digital commands can set any or all

of the instrument's controls.

There's never any question about a reading's accuracy, even when the input goes out of range or contains noise. Whenever the input goes too high for the instrument, it's overrange digit, a "1", blinks, telling the user that the reading no longer is to specified accuracy.

If the noise level is too high, the 6853 desensitizes itself. Whenever

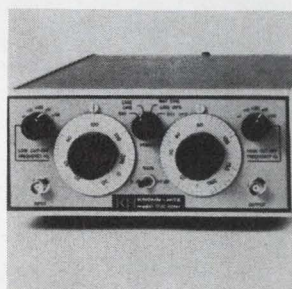

Variable band pass filter model 3700, for low frequency operation, might be operated either directly from line voltage sources or, where applications require complete isolation from line, from internal batteries. Upper and lower cutoff frequencies are independently adjustable from 0.2 hz to 20 khz in 5 bands. Krohn-Hite Corp., 580 Massachusetts Ave., Cambridge, Mass. [361]



Ten point scanner model 634 is used to sequentially transfer analog data from multiple sources to one measuring instrument. Scanning is accomplished by two-pole reed relays suitable for switching low level sources, such as thermocouples. Dwell time on each point is adjustable by front panel control. Price is \$575. United Systems Corp., 918 Woodley Rd., Dayton, Ohio 45403 [362]

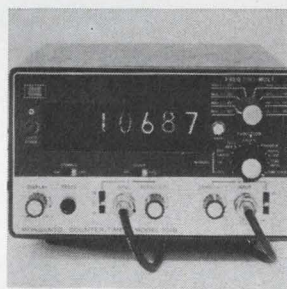

Digital counter/timer model 101B offers 50 Mhz counting rate, dual input channels, a true time-interval measuring capability, display storage, five-digit display and BCD output for data handling equipment. Internal frequency reference is a 1 Mhz crystal oscillator. Price is \$695 and delivery is from stock. Monsanto Electronic Instruments, 620 Passaic Ave., W. Caldwell, N.J. [363]

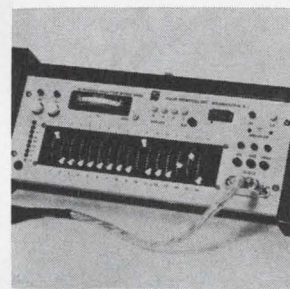

Versatile analyzer model 2080 is for testing IC's and modules. It contains a built-in stimulator-generator, monitor, and IC power supply, and eliminates the need for any peripheral test instrumentation. The internal power supply provides 3 to 7 v for energizing chips or modules under test. Model 2080 is 16 x 10 x 6½ in. Pulse Monitors Inc., 351 New Albany Rd., Moorestown, N.J. [364]



Automatic diode classifier type D189 can test over 10,000 diodes an hour, making all standard tests and assigning devices to as many as 8 different categories. It measures reverse voltage to 1,200 v in 2 ranges and can deliver up to 10 amps for forward-voltage tests. Reverse-leakage-current range is 0.005 to 1,000 µa. Price is \$13,500. Teradyne Inc., 183 Essex St., Boston. [365]

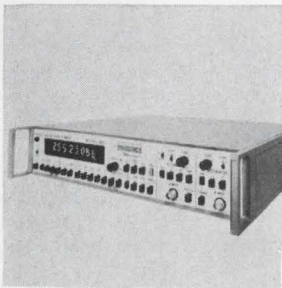

Digital counter/timer model 461 with 10 mv sensitivity measures frequency, period, multiple period, frequency ratio, multiple frequency ratio and time intervals, and totalizes. The standard configuration provides a counting rate of from d-c to 20 Mhz, and displays measured units on a seven-digit display with storage. Dynasciences Corp., 9601 Canoga Ave., Chatsworth, Calif. [366]

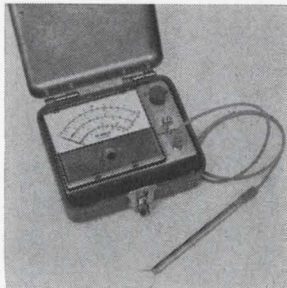

R-f voltmeter model 500 covers the frequency range from 20 khz to 500 Mhz with a voltage range from 200 mv to 15 v rms. From 20 khz to 100 Mhz, measurements are accurate to 3% of full scale; from 100 to 200 Mhz, accuracy is 5%; and from 200 to 50 Mhz, voltages are read from a calibration curve. High Frequency Engineering Co., 2626 Frontage Rd., Mountain View, Calif. [367]

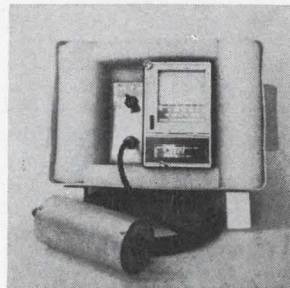

Transient recorder 111B has a self-contained probe detector and strip chart recorder for logarithmically displaying transients from 1 v to 1,000 v (60 db dynamic range) with no required scale adjustments. Frequency response of 50 khz is provided to compress transient data storage recordings by 100,000:1. White Electromagnetics Inc., Lofstrand Lane, Rockville, Md. [368]



# How to Win the Game

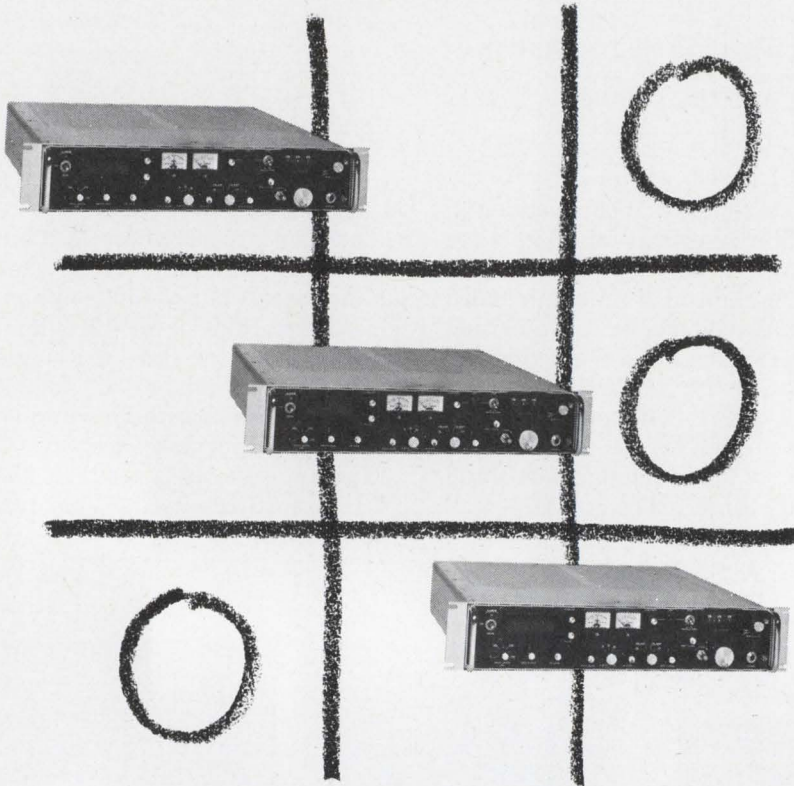

## With W-J HF/VHF/UHF RECEIVERS

This well-established family of W-J receivers offers a wealth of special features in separate units designed for critical surveillance and monitoring applications.

### TUNING RANGE

Type 521A	HF Receiver	20-70 MHz
Type 555	VHF Receiver	90-180 MHz
Type 595	UHF Receiver	220-400 MHz

### FEATURES:

- Built-In Signal Monitors
- Carrier-Operated Relay (COR)
- Independently variable Beat Frequency Oscillator (BFO)
- Accurate, Readable 26-Inch Steel Tape Dials
- Digital Automatic Frequency Control (DAFC)

World's Largest Selection of Receiving Equipment for Surveillance, Direction-Finding and Countermeasures

CEI DIVISION

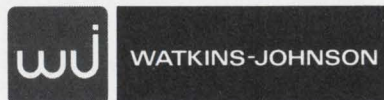

6006 EXECUTIVE BOULEVARD, ROCKVILLE, MARYLAND 20852 • (301) 881-3300

its input amplifier doesn't settle within 75 milliseconds of receiving an input, the instrument blanks its least significant digit, and measures again, this time with four-digit accuracy. If again the amplifier doesn't settle, the next least significant digit goes out. When the noise level drops, the instrument returns to full accuracy.

**Three options.** The 6853's basic box measures ratios, from 0.1:1 to 1,000:1, and d-c voltages, and sells for \$4,095. The four voltage ranges run from  $\pm 1.09999$  volts full scale to  $\pm 1099.99$  volts full scale and accuracy is 0.005% of reading  $\pm 0.001\%$  of full scale. Response time is 35 msec.

Cimron engineers make three converters, all on printed-circuit

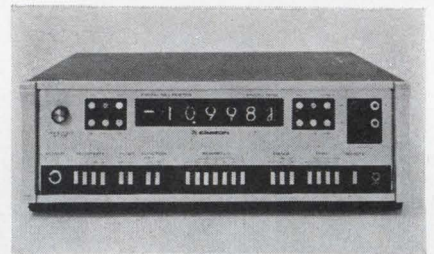

**Card converters.** The meter's a-c and resistance-measuring circuits are on plug-in p-c cards.

cards which plug into the basic instrument.

The 5875 a-c converter, priced at \$695, averages a-c inputs and displays their rms values. This converter has the same four voltage ranges as the basic instrument, and a bandwidth from 50 hertz to 100 kilohertz. Accuracy at the high-frequency end is 0.4% of reading  $\pm 0.05\%$  of full scale, and 0.08% of reading  $\pm 0.02\%$  full scale at the low end.

The 5889 mv/ohms converter, which sells for \$720, gives the instrument ranges of 1, 10, and 100 kilohms, and 1, 10, and 100 megohms. Accuracy is around 0.01% reading  $\pm 0.005\%$  full scale. Besides this, it gives the meter two additional voltage ranges—10 and 100 millivolts.

The 5891 ohms/range extender costs \$500 and adds ranges of 1, 10, and 100 ohms, and 1, 10, and 100 kilohms.

Cimron Division, 1152 Morena Blvd., San Diego, Calif. 92110 [369]



# Special introductory offer to new members of the ELECTRONICS AND CONTROL ENGINEERS' BOOK CLUB

	<b>A042/500</b> <b>NUMERICAL CALCULATIONS AND ALGORITHMS</b> by Beckett & Hurt Pub. price, \$10.50 Club price, \$8.95		<b>A494/754</b> <b>ENGINEERING MANUAL, 2/e</b> by R. H. Perry Pub. price, \$12.50 Club price, \$9.95
	<b>A101/094</b> <b>MICROELECTRONIC CIRCUITS AND APPLICATIONS</b> by J. M. Carroll Pub. price, \$12.00 Club price, \$10.25		<b>A523/401</b> <b>CHARACTERISTICS AND OPERATION OF MOS FIELD-EFFECT DEVICES</b> by P. Richman Pub. price, \$10.00 Club price, \$8.50
	<b>A286/507</b> <b>SOLID-STATE ELECTRONICS</b> by R. G. Hibberd Pub. price, \$9.50 Club price, \$7.95		<b>A037/604</b> <b>DIGITAL LOGIC AND COMPUTER OPERATIONS</b> by Baron & Piccirilli Pub. price, \$14.50 Club price, \$11.95
	<b>A287/457</b> <b>SUCCESSFUL ENGINEERING MANAGEMENT</b> by T. G. Hicks Pub. price, \$8.95 Club price, \$7.25		<b>A423/814</b> <b>PULSE, DIGITAL AND SWITCHING WAVEFORMS</b> by Millman & Taub Pub. price, \$18.00 Club price, \$15.34
	<b>A347/506</b> <b>ELECTRONIC DIGITAL TECHNIQUES</b> by P. M. Kintner Pub. price, \$12.50 Club price, \$10.65		<b>A565/031</b> <b>AMPLIFIER HANDBOOK</b> by R. F. Shea Pub. price, \$37.50 Club price, \$29.50
			<b>A637/377</b> <b>TRANSISTOR CIRCUIT DESIGN</b> by Texas Instruments, Inc., Staff Pub. price, \$16.50 Club price, \$14.05
			<b>A126/070</b> <b>PRINTED CIRCUITS HANDBOOK</b> by C. F. Coombs, Jr. Pub. price, \$17.75 Club price, \$14.95
			<b>A610/037</b> <b>MODERN COMMUNICATION PRINCIPLES</b> by Stein & Jones Pub. price, \$15.00 Club price, \$12.75
			<b>A259/607</b> <b>COMMUNICATION SYSTEM ENGINEERING HANDBOOK</b> by D. H. Hamsher Pub. price, \$29.50 Club price, \$24.95

**ANY ONE**  
of these great professional books  
for only **\$1.00**  
VALUES FROM \$8.95 to \$37.50

Special \$1.00 bonus book comes to you with your first club selection

## Save time and money by joining the Electronics and Control Engineers' Book Club

HERE is a professional club designed specifically to meet your day-to-day engineering needs by providing practical books in your field on a regular basis at below publisher prices.

**How the Club operates:** Basic to the Club's service is its publication, the *Electronics and Control Engineers' Book Club Bulletin*, which brings you news of books in your field. Sent to members without cost, it announces and describes in detail the Club's featured book of the month as well as alternate selections which are available at special members' prices.

When you want to examine the Club's feature of the month, you do nothing. The book will be mailed to you as a regular part of your Club service. If you prefer one of the alternate selections—or if you want no book at all for that month—you notify the Club by returning the convenient card enclosed with each *Bulletin*.

As a Club member, you agree only to the purchase of four books over a two-year period. Considering the many books published annually in your field, there will surely be at least four that you would want to own anyway. By joining the Club, you save both money and the trouble of searching for the best books.

## MAIL THIS COUPON TODAY

ELECTRONICS AND CONTROL ENGINEERS' BOOK CLUB  
330 West 42nd Street, 18th fl., New York, N. Y. 10036

Please enroll me as a member of the Electronics and Control Engineers' Book Club and send me the two books indicated below. I am to receive the bonus for just \$1.00, and my first selection at the special Club price shown. These books are to be shipped on approval, and I may return them both without cost or further obligation. If I decide to keep the books, I agree to purchase as few as four additional books during the next two years at special Club prices (approximately 15% below list).

Write Code No. of  
bonus book  
here

Write Code No. of  
first selection  
here



Name \_\_\_\_\_

Address \_\_\_\_\_

City \_\_\_\_\_

State \_\_\_\_\_ Zip \_\_\_\_\_

E33125





## EVER SEE THIS COLLECTION OF POWER RESISTORS BEFORE?

Don't feel left out because no one else has either. Each resistor or network illustrated is designed for custom fit and performance in some customer's special application.

If provided a few details of your extraordinary resistor needs perhaps SAGE can help you out too. Write or call industry's leading producer of miniature precision wire-wound resistors. SAGE ELECTRONICS CORPORATION, Box 3926, Rochester, New York 14610 • Telephone: (716) 586-8010.

Precision Power Resistors

# SAGE

## ELECTRONICS

SUBSIDIARY OF GULTON INDUSTRIES, INC.

New instruments

## Something new in finding Q

Analog outputs allow meter to work in test systems; range covers 5 to 1,000

**Designing Q meters** isn't a lost art after all; it's still alive in Tokyo at Yokagawa-Hewlett-Packard Ltd. There, engineers have designed the 4342A, which measures Q's from 5 to 1,000 over a range of 22 kilohertz to 70 megahertz, and generates analog outputs.

Measuring Q—the ratio of a component's series reactance to series resistance—is an indirect but easy way to measure a coil's impedance.

The first Q meters appeared in the 1930's and haven't changed much since then. In fact the 260A, H-P's present Q meter, is one of the oldest instruments in its catalog.

For the most part, the new meter's specifications are little better than those of the 260A. The 4342A has a slightly wider frequency band and almost twice the Q range, but at \$1,500 it costs \$150 more. The  $\Delta Q/Q$  range of the new meter is 0 to 100; it's 0 to 50 on the old model. But the 4342A is a child of the systems age. It has four rear-panel outputs—a 1-volt d-c signal proportional to the measured Q; a frequency-monitor signal whose minimum value is 170 millivolts rms into a 50-ohm load; a signal that indicates if the measured Q passes some preset limit; and a switch closure that also announces when that limit is exceeded. With these outputs, the 4342A can both fit into automatic test systems and sent data to logging gear.

The 4342A is easier to use than older Q meters—it requires no dial twiddling. Pushbuttons set the ranges, and an automatic leveling circuit holds the output of the meter's oscillator constant.

The meter is 6 inches high and 1½-foot square, weighs 31 pounds, and draws 25 watts.

Hewlett-Packard Co., 1501 Page Mill Rd., Palo Alto, Calif. 94304 [370]



# In Florida Business Adds Up!

**We've Got the Competitive  
Edge For New Industry –  
And We Can Prove It!**

When you add up the competitive advantages that are part of Florida industrial site selection, it's a stopper.

We can show you a variety in site selection few other states can boast. Where else can you have your choice of **13** deepwater ports — more than many foreign countries?

We have a new set of laws concerning revenue bond financing that will make your comptroller's eyes light up.

Our recruitment and training program solves the staffing problem before you open your doors. (And at no cost to you!)

For the young and technically skilled we have educational, recreational, and living advantages that make Florida a prime attraction.

Florida has a great deal for you. Before you make a move, take a good look at that competitive edge. Phone (904) 224-1215, or send the coupon.

## Florida

DEPARTMENT OF COMMERCE  
107 WEST GAINES STREET  
TALLAHASSEE, FLORIDA 32304

**HANDY COUPON FOR YOUR CONVENIENCE!**

**Florida Department of Commerce / 107 West Gaines St.  
Tallahassee, Florida 32304 / Att.: Dept. "D-1"**

*I'm interested in a business or industrial future in Florida.  
Please send me more information.*

Name .....

Title or Position .....

Company .....

Street .....

City ..... State ..... Zip.....



# Vidicon shines at low light levels

Second-generation silicon-target tube has improved sensitivity, fast scan for military and industrial surveillance applications

**Vidicon tubes**, using silicon targets for their image generation, have been on the market for several years. In fact the RCA 8507, a separate-mesh vidicon, has been around since about 1963 and is still a good seller. But these older tubes have difficulties that restrict their use. Excessive image retention because of photoconductive lag is particularly troublesome under

scan conditions. Overexposure of the image-sensing layer to a high-level pulse may permanently damage the photoconductive coating. Also, the limited sensitivity and narrow spectral response generally require that some auxiliary lighting be used for sufficient signal-to-noise ratios, especially in applications—such as surveillance or closed-circuit tv—where picture clarity is

an essential requirement.

A new vidicon from Texas Instruments does away with many of these limitations, principally because of a radically different light-sensing layer within the tube. Consisting of a single crystal mosaic of from 300,000 to 750,000 photo-diodes, this light-sensing layer is read by a scanning electron beam in a manner similar to other vidi-

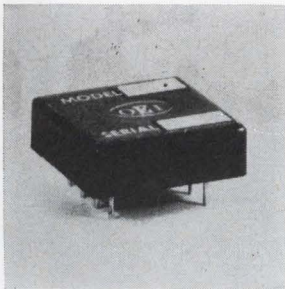

Sample-and-hold analog memory model 5204A is packaged in the low profile, 1 in. square x 0.31 in. high encapsulated module for p-c board mounting. It features 100 mv/sec memory decay,  $\pm 10$  v full scale, d-c to 1 khz large signal frequency response,  $\pm 1\%$  maximum error, and 3  $\mu$ sec aperture time. Single unit price is \$60. Optical Electronics Inc., P.O. Box 11140, Tucson 85706 [381]

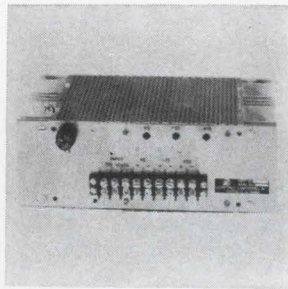

Multi-output power supplies are custom designed for OEM applications. Voltage, current, power, and package configuration are tailored to customer's requirement. Packages from 25 to 150 w are available with as many as 6 output voltages. Model CPS-103 pictured features 5 v at 2.5 amps and  $\pm 15$  v at 1 amp. Astro-Space Laboratories Inc., 110 Wynn Dr., N.W., Huntsville, Ala. [382]

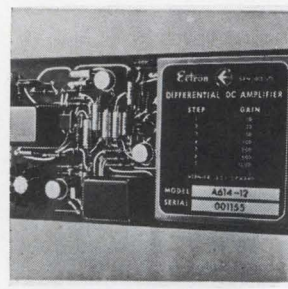

Differential d-c amplifier model A614 is intended for narrow band applications below 5 khz. Noise in a 10 hz bandwidth is well under 0.5  $\mu$ v peak to peak and zero shift with a full 500 ohms source is under 0.5  $\mu$ v per  $^{\circ}$ C over the range of  $-20^{\circ}$  to  $+71^{\circ}$ C. The standard A614 provides 7 fixed gain steps to X1000. Ectron Corp., 8070 Engineer Rd., San Diego Calif. 92111 [383]

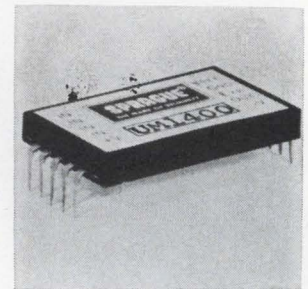

Digital-to-analog converters series UM-1400 Moduline are packaged in a modified plastic dual in-line case. The basic unit contains 4-bit d-a converters with hermetically sealed components, including a buffer amplifier, ladder network, and ladder switch. The UM-1410 Moduline expansion module is accurate to  $\pm \frac{1}{2}$  lsb at 8 bits. Sprague Electric Co., North Adams, Mass. [384]

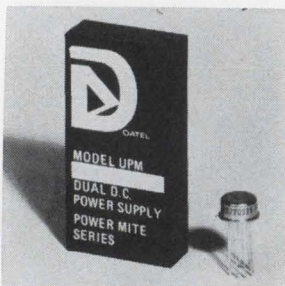

Ultraminiature dual d-c power supply model UPM 15-50 ( $\pm 15$  v d-c at 50 ma) is for powering linear IC's. It measures only 1 x 2 x 0.4 in. It can mount directly on p-c boards having 0.5 in. centers. One supply can power up to ten 709 operational amplifiers. Price is \$59 in single quantity, with delivery in two weeks. Datal Corp., 943 Turnpike St., Canton, Mass. 02021 [385]

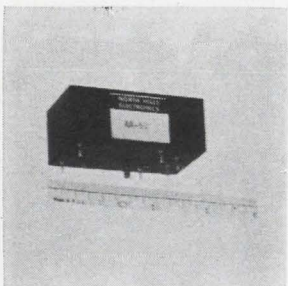

Precision loadable series RA-50 d-c voltage reference sources are designed for p-c board mounting for use as systems modules. They accept an unregulated d-c input which can vary as much as  $\pm 10\%$  and convert it to an ultrastable 10 v d-c, 0 to 5 ma output. Price is \$124.50; delivery, from stock. North Hills Electronics Inc., Glen Cove, Long Island, N.Y. 11542 [386]

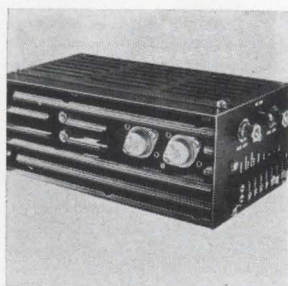

Compact power supply CR55 is for IC, strain gauge and transistor powering. It features a heat sinking method that permits full ratings at  $71^{\circ}$ C ambient with convection cooling. Output is 5 v d-c with an adjustment range of  $\pm 5\%$ . Line regulation is within 0.05% and load regulation within 0.03% for a 0-100% load change. Electronic Research Associates Inc., Cedar Grove, N.J. [387]

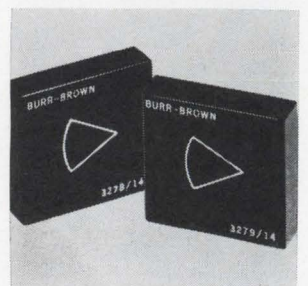

FET operational amplifiers 3278/14 and 3279/14 are for fast settling to step inputs. Maximum settling time to 0.01% of final value is 1  $\mu$ sec. Minimum slew rate is 32 v/ $\mu$ sec; minimum full-power bandwidth is 500 khz. Units are stable up to 1,000 pf of capacitive load without external compensation. Burr-Brown Research Corp., Int'l Airport Industrial Park, Tucson [388]



# Is the 901 counter-timer just too good to be true?



Shown with optional 1.3-GHz plug-in.

# NO!

## It was...but it's not any more!

Last year, when we introduced the Model 901, we were years ahead of the industry. Here was the first state-of-the-art universal counter-timer that could count directly to 200 MHz without a plug-in, and—with a plug-in—could go right on counting into the gigahertz range. What's more we offered it at the unheard of low price of only \$2475—about \$250 to \$1000 below the nearest competition!

It wasn't long before we knew we had a tiger by the tail. Here was a dream instrument with all the universal counting and measuring functions built into the standard main frame...with gate times of 1  $\mu$ s to 100 sec instead of to just 10 sec...with a TIM with a resolution of 10 nsec instead of 100...with an input sensitivity of 10 mV instead of the usual 50 or 100...with 9-decade readout instead of just 8...and with remote control available as an optional extra. With all that going for us we had just one problem: how to get into volume production fast enough to meet demand.

Now cut to 1970. The industry still hasn't caught up with the Model 901, but our production has caught up with demand. You can now buy this state-of-the-art instrument *right off the shelf* for the same low price. What's more, for only \$825 extra, you can also have the Model 931 Heterodyne Converter plug-in that extends the 901 frequency range up to 1.3 GHz.

*But why dream on? Why wait to catch up to the times? The 901 is a reality today. For the full facts, circle the reader service card.*

COMPUTER MEASUREMENTS



A DIVISION OF NEWELL INDUSTRIES

12970 Bradley/San Fernando, Calif. 91342/(213) 367-2161/TWX 910-496-1487



# BUGS ARE BIG BUSINESS

Every year a million dollars go down the drain because "bugs" are big business in components. Buggy coils and transformers can cause many costly breakdowns. It's enough to bug anyone! And it's about time bugs were stamped out. For years Delevan has been waging an intensive campaign to exterminate this threat. That's why Delevan uses X-Ray and fluoroscopic equipment to insure consistent quality and long life in its magnetic components. Long ago, Delevan adopted rigorous manufacturing controls in order to meet stringent military standards. A continuous audit of these controls is conducted by our Defense Supply Agency approved environmental laboratory. That's why Delevan is testing to the latest revision on Mil C 15305 rev. D—testing that includes 2,000 hr. life test, 15 g force vibration, 50 g force impact, 10 day moisture resistance, and temperature cycling. And that's how Delevan catches the bugs before they catch you. Send for a Catalog of Our "bugless" Products.

**Delevan**  
Division  **AMERICAN  
PRECISION  
INDUSTRIES INC.**

270 QUAKER RD. / EAST AURORA, N. Y. 14052  
TELEPHONE 716/652-3600 TELEEX 091-293  
OTHER DIVISIONS OF AMERICAN PRECISION INDUSTRIES INC.: BASCO-DUSTEX-  
MOELLER INSTRUMENT CO. - OXFORD CORP. - TRUCK EQUIPMENT CO.

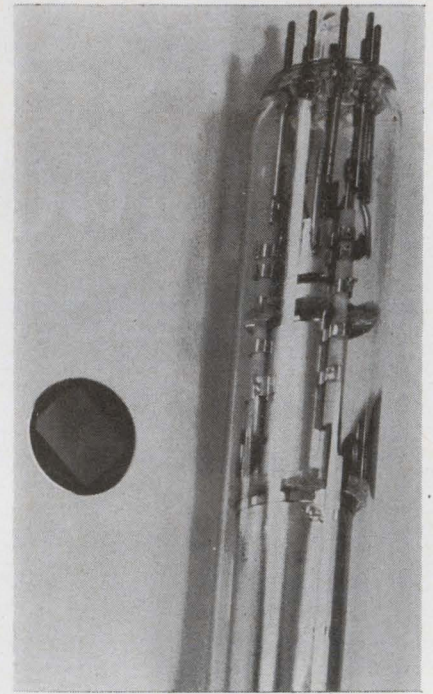

**Sensor.** Tube's target array, left, contains up to 750,000 diodes.

cons. The tube utilizes magnetic focus and deflection of the electron beam. The substrate is typically 10 $\Omega$ -cm, n-type silicon. The p-type islands are formed by diffusing boron through holes cut in the silicon-dioxide layer by a photolithographic process. A semi-insulating layer is applied.

The high-density diode array is largely responsible for the performance of TI's vidicon, called the Tivicon. Its spectral response, unlike that in the old vidicons which cut off at approximately 0.65 micron, extends to 1.1 microns. Moreover, it is 20 times more sensitive to light from an ordinary tungsten lamp, thus eliminating the need for special sources. But even with this increased range, the tube is not susceptible to high-light-level damage. And with this design, image retention or lag is reduced by a factor of nearly two in good light conditions. Further, the tube is compatible with most one-inch vidicon cameras.

**Longer life.** The improvement in image retention of TI's vidicon at high light levels results directly from the 10-to-100-microsecond minority carrier lifetimes in the silicon target. This means that for a signal level of 0.50 microamp, the residual signal of the TI tubes after 50 milliseconds of dark is 8%, or



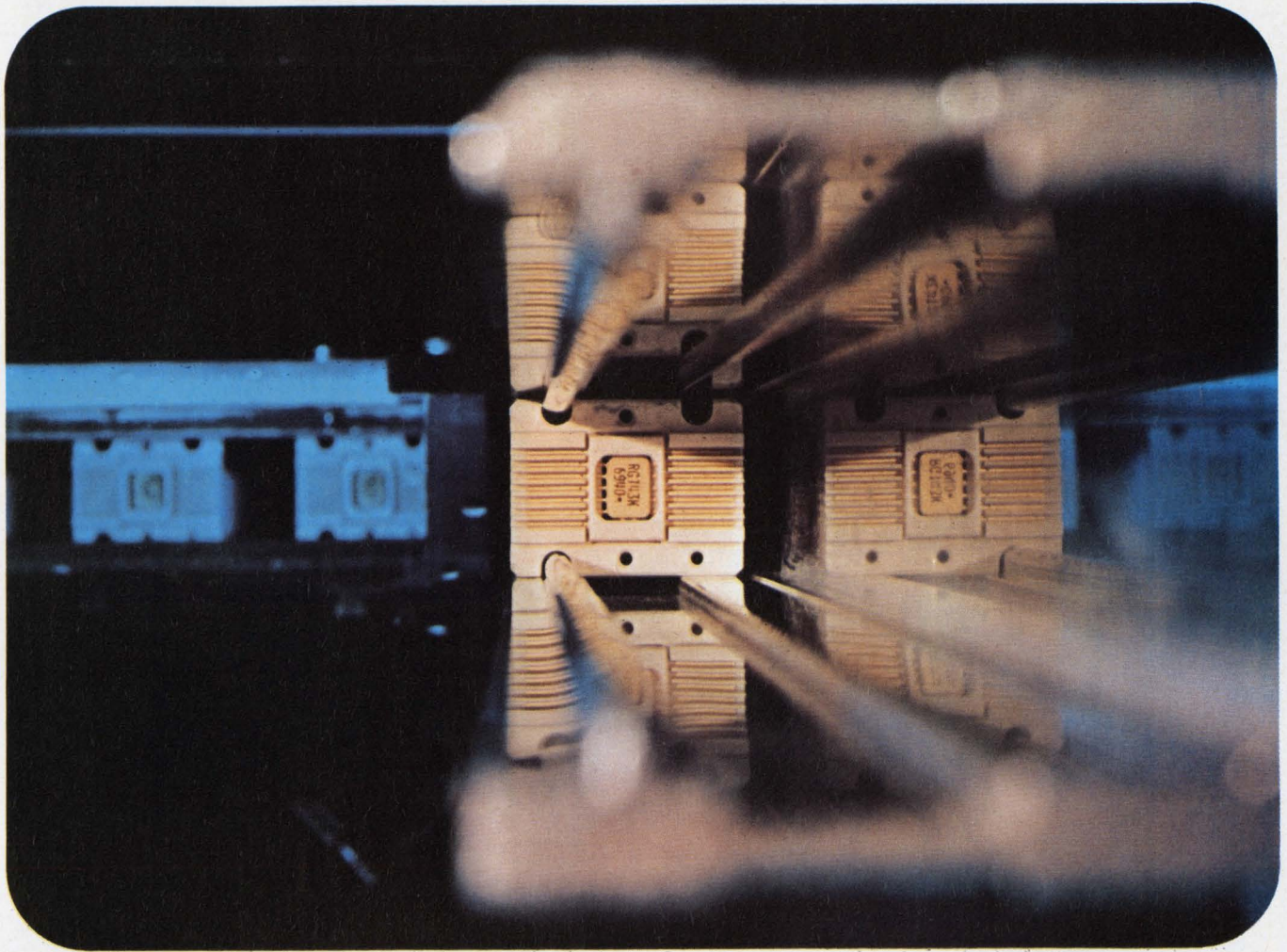

## a new concept in **DIGITAL TESTING**

Modern digital equipment is rapidly becoming the nerve center for industry. Accurate, dependable, around-the-clock operations is a necessity. Failures in digital equipment can result in unacceptable losses of time and revenue in these operations.

Product reliability, therefore, has taken on a new and more significant meaning.

New reliability standards necessitate testing at all levels in the manufacturing process. Faults must be detected at the lowest possible level. The testing must not only detect failed devices but also marginal or intermittent ones. It must test the device at its operational limits over various stress levels in order to force these failures.

Current test methods are inadequate to achieve this new level of reliability. Parameter testing, the heretofore accepted method of testing, is not adequate for the complex devices of the future. Such testing is time consuming, expensive and impractical since it is nearly impossible to prepare adequate test requirements. Computers can be used for comprehensive test generation, but the magnitude of the task makes machine time prohibitive. Computer-aided testing requires large amounts of storage and wide data bandwidths which further contribute to the cost.

The Collins digital pseudorandom inspection (DPI) system overcomes the basic limitations of present test methods by providing a level of testing that formerly involved unacceptable costs.

Digital pseudorandom inspection systems are high-volume

testing systems for digital devices in wafer, chip, integrated circuit, card or unit configurations, and they represent one of many types of work stations that can be operated in a Collins C-System controlled manufacturing facility.

Collins DPI system employs feedback sequence testing whereby self-generated test sequences are provided by the unit under test. This concept permits comprehensive testing combined with control of critical parameters such as temperature, timing and measurement levels.

Using this test concept, test preparation is simplified, devices can be tested at their design clock rate, and a minimum of data bandwidth and storage is required. A wide range of voltage, timing and temperature settings is available to permit simulation of actual stress levels. In addition, unique mechanical handling equipment is available to obtain high test throughput.

On-line connection to the Collins C-System provides the benefit of a central file for test programs, scheduling of work load and a central source of test results.

The DPI system is another example of the engineering and manufacturing excellence achieved with Collins C-System technology with the goal of improved product reliability at lower product cost. For more information about this unique testing concept, write Collins Radio Company, Dept. 300, Dallas, Texas 75207.



COMMUNICATION / COMPUTATION / CONTROL



# THE COCKY LITTLE TRANSIENT QUENCHER FROM JOSLYN

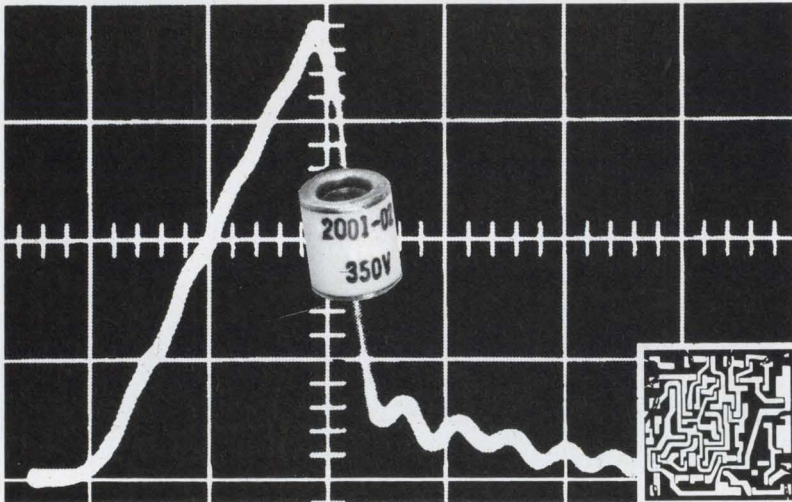

 Transients have never been able to knock off solid-state electronics when Joslyn precision protection devices are on guard duty. \*Never! They quickly extinguish damaging transients with extreme accuracy, nano-second response, and high repeatability over an unequalled period of time. Ideal for protecting AC and DC input lines, RF systems (transmitting or receiving), balanced and unbalanced transmission lines, radar modulators, traveling wave tubes, and cathode ray tubes. Contact Joslyn today for full information and delivery from stock for the field-proven cocky little spark gap that will solve your particular protection problem. Full line includes surge protectors and lightning arresters. \*when properly selected and connected



## JOSLYN

### ELECTRONIC SYSTEMS

Joslyn Electronic Systems  Santa Barbara Research Park   
P.O. Box 817  Goleta, Calif. 93017  Tel. (805) 968-3551

1813

approximately one-half that expected from the older vidicons.

At intermediate levels the Tivicon's lag is approximately the same as that of earlier vidicons. However, under low-level illumination or residual-signal conditions, the Tivicon shows performance gains. The time required for reduction of a signal of any intensity to 1% of its initial value can be as high as 3 seconds for the vidicon; the Tivicon, having only discharge lag, will reach the same residual level in a value of 250 millamps or less.

The Tivicon possesses not only a very broad band near infrared response—common to all silicon-target tubes—but also a higher peak quantum efficiency. This means a greater sensitivity.

**Hard limit.** The discrete-diode nature of the Tivicon target puts a hard upper limit on the resolution. Assuming a rectangular array with scanning aligned with the array matrix, the upper usable horizontal resolution is determined by the number of diodes scanned. In the case of 20-micron spacings and  $\frac{1}{2} \times \frac{3}{8}$  inch scan, this resolution figure is about 470 tv lines.

For a given target thickness, the Tivicon limiting resolution and modulation may be improved by a manipulation of array density, scan size, and semi-insulating coating resistivity. For a dense array, say a 20-micron array, a limiting resolution of 700 tv lines is possible by adjusting the scan angle and size, with 900 tv lines possible with a further increase in density.

**Versatile.** The Tivicon is suitable for black-and-white work in both studio and normal industrial-surveillance applications at greatly reduced light levels. More important perhaps is its special compatibility with radiation from xenon arcs and gallium arsenide and neodymium-laser sources for near i-r and 1.06 micron radiation respectively. Since xenon and gallium arsenide emit infrared energy near the Tivicon peak response, they can be used as efficient sources for surveillance in areas such as hospital intensive-care wards, police investigations, and military night operations.

Prices range from \$750 each to \$4,400 each, depending on the resolution and dark current required.

Texas Instruments Incorporated, P.O. Box 5012, Dallas, Texas 75222 [389]



# Cut yourself in.



**“Scissors draft” your way to increased production with KODAGRAPH Films and Papers.**

Why retrace an entire drawing needing only revision? Instead, copy your original photographically on KODAGRAPH Film or Paper. Cut out the unchanged portions (often much of your drawing), mount them on a new drawing form, have a second original made on KODAGRAPH Film, and make your revisions on that.

For more on “scissors drafting” and other time-saving techniques, contact your Kodak Technical Sales Representative, or write Eastman Kodak Company, Business Systems Markets Division, Dept. DP 713, Rochester, N.Y. 14650

**DRAWING REPRODUCTION SYSTEMS BY KODAK**

Kodak



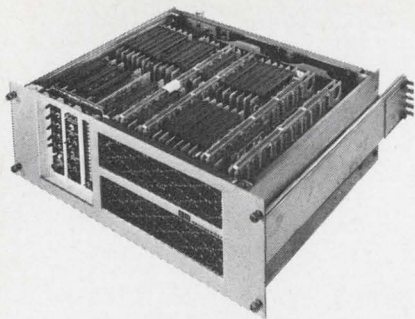

High speed commercial memory system — **NANOMEMORY 2600**. Full cycle time of 600 nanoseconds, and word capacities of 16K by 18 or 8K by 36. It's all done with a second-generation 2-1/2D drive system with efficient circuit and logic design, for reduced component count and high MTBF, and wide operating margins—the real feature of the 2-1/2D configuration. It is easily expandable in the field, and comes in a standard 19" rack.

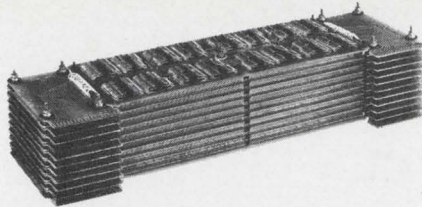

Perfect for high speed, large capacity mainframe memory systems... **NANOSTAK 3020**...technology breakthrough in 3W, 2-1/2D stacks. Stackable, compact size is an amazing 25% of competitive planar stacks and offers a significant advantage in form factor for system packaging. Extremely fast 650 nanosecond cycle time for 8K or 16K by 40, or 32K by 20 word memories.

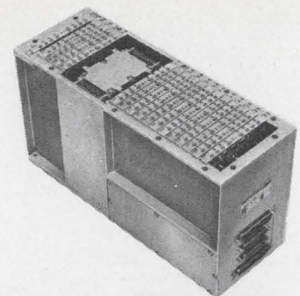

Compact, ATR compatible memory system **SEMS-6** for use in military and rugged commercial aircraft applications. Reliable performer is optimized around 8K or 16K with maximum capacities of 8K by 40 or 16K by 20. Full cycle time of 2 microseconds, with access time of 700 nanoseconds. Meets MIL-E-5400, low power consumption and lightweight.

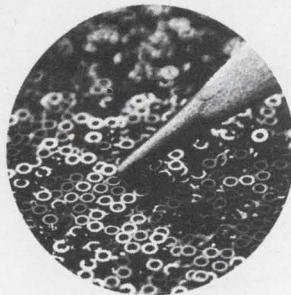

Five new memory cores for your next stack or system. All are medium or high drive, all coincident current, and all are fast switching for your high speed applications. Four new cores available in 18 mil, 20 mil, and two types of 30 mil sizes for use from 0° to 70°C. Also, a new wide temperature range 18 mil core for severe environments of -55° to +100°C.

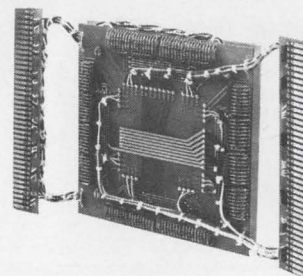

Rugged design for ground based mobile equipment, **NANOSTAK 020** commercial memory stack. High speed 850-nanosecond full cycle time for 4K memories. Features 3W, 3D organization with word capacities to 16K by 40. Built-in reliability and dependability. Available with wide temperature range cores for operation in severe environments.

# Who else but Electronic Memories could introduce five brand spanking new memories—at once

Only Electronic Memories, the technology leader, could introduce five important new memories at once. Each one offers significant advances to provide you with faster, more reliable, and lower cost memories. Each one is loaded with outstanding new design features to give you faster access, larger capacity, and more economical operation. From cores and stacks to megabit memories, Electronic Memories has the memory products for your next, faster, more powerful computer system. For more facts and figures, just write.

**em** **electronic memories**  
a division of electronic memories & magnetics corporation  
12621 chadron avenue, hawthorne, california 90250  
telephone (213) 772-5201 TWX: 910-325-6213



# Vacuum holds circuit probe in place

Designed for testing resistance values on hybrid IC's, instrument is not hampered by silicon dust from trimming work

**Most circuit probes** are bolted to a table, and the probe needle is positioned by micrometers which control its x- and y-axis movements. This can be time-consuming since each micrometer may have to be turned many times to place the needle. And when these probes are used in conjunction with resistor-trimming of hybrid IC's, for example, their x-y positioning threads

can be clogged by abrasive dust generated during the trimming process and spread around the surrounding work area.

Probes held by magnets are easier to move in their x-y axes, but they require metal tables, and they don't hold tightly to dusty surfaces.

The MPM Corp., says it has solved these problems with a probe

for resistor-trimming applications called the MP-100 mini-probe. When a lever on the side of the instrument is set to the 'on' position, a vacuum causes the probe to grip any flat surface. A rubber seal under the instrument holds the vacuum and adheres to the surface despite the effects of silicon dust or dirt. When the switch is off, the probe can be picked up

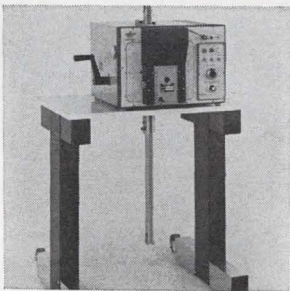

Mini-Charger 8014 is a manually operated handler that conditions IC's through an environment of  $-65^{\circ}$  to  $+150^{\circ}\text{C}$ . Easily accessible test contactors can be interchanged within 5 minutes to permit handling of T0-5, short and long lead, dual in-line pack, and flatpack devices, in carriers, in an environment of  $\pm\frac{1}{4}^{\circ}\text{C}$  at the test contactor. Delta Design, Box 1118, La Mesa, Calif. [421]

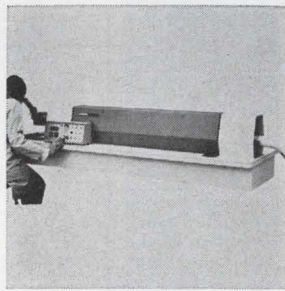

Laser scribing system model 2100, for scribing ceramic substrates, features a high-power 100-watt output laser and a fast 6 in./sec digitally controlled stepping table. With laser scribing, it is possible to scribe and fracture into much smaller pieces than under other methods. Accuracy is  $\pm 1$  mil. Mechanization Associates, 140 S. Whisman Rd., Mtn. View Calif. 94040 [422]

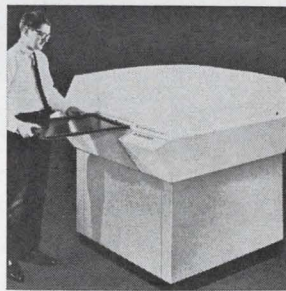

Fully automatic, light-tight photo-plotting system, the Compucircuit 100, will produce artwork masters for printed circuits or IC's. It accommodates glass plate or film loaded by cassette, and eliminates need for a darkroom. Input may be from off-line magnetic tape, remote phone-coupled time sharing, or dedicated on-line computer. Computervision Corp., Burlington, Mass. [423]

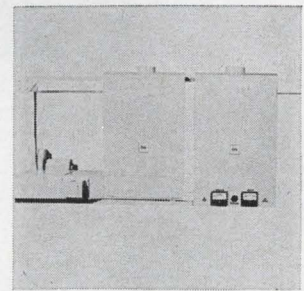

Dual oven will speed-dry photoresist on copper-plated through-hole p-c boards while limiting ring formation around the holes. Precision control of ring size is important in protecting the walls of the holes. The dual oven is conveyORIZED and consists of a hot-air impingement unit and a bench oven, with infrared heaters. Infra-Red Systems Inc., Route 23, Riverdale, N.J. [424]

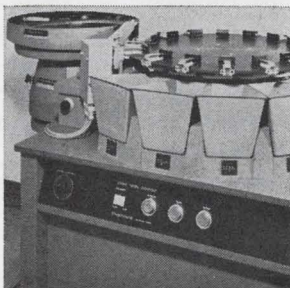

Transistor sorter type 1635 was developed to automatically test and sort T0-105 and T0-106 epoxy type transistors at a rate of 5,000 or more per hour. It automatically feeds components from a vibratory bowl via an orienting track to a 16-station index table which advances them to either a single or dual test probe. Daymarc Corp., 40 Bear Hill Rd., Waltham, Mass. [425]

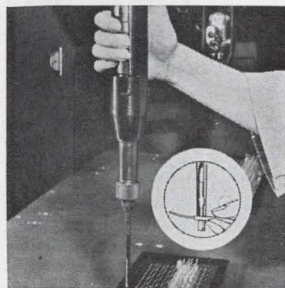

Pneumatically-operated sideloading wire-wrap tool is for use with semiautomatic P/2/P wire terminating systems. The sideloading pneumatic gun permits easy wire insertion, with the operator simply laying it on the side of the open bit. Operator has single-hand control of bit closure and gun actuation. Synergistic Products Inc., 150 E. Stevens St., Santa Ana, Calif. 92707 [426]

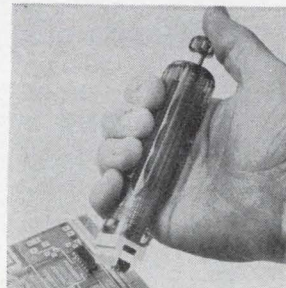

Spring-loaded hand tool is for inserting DIP's into p-c boards. Most hole patterns are slightly narrower than the actual lead spread, so the DIP will remain firmly in the board during handling or wave-soldering. With this tool DIP's are automatically squeezed to fit the hole pattern and then ejected when firmly placed. Hunter Tools, Santa Fe Springs, Calif. [427]

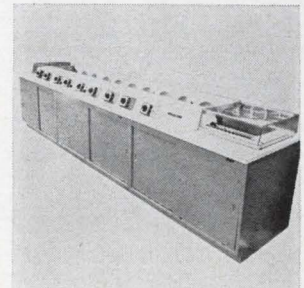

Automatic photomask developing system model 3100 is self-loading and unloading at beginning and finish of the process sequence. An adjustable timer at each tank allows independent time setting at each step. Once the process timers are set, the machine will automatically transfer the carriers from tank to tank. Fluoroware of California, 37433, Centralmont Pl., Fremont, Calif. 94536 [428]





# Knowledge... ...the defense

As in times past, we sometimes blame things that we do not understand on Black Magic. Many think there is Black Magic in integrated circuit technology.

- The INVESTOR sees it as the lack of profits,
  - ENGINEERS — as a circuit that will not work in his systems,
  - QUALITY ASSURANCE managers — as systems equipment failures,
  - PURCHASING AGENTS — as non-delivery,
  - MARKETING men — as radically shifting systems prices they do not understand,
  - and to MANAGEMENT it is the mass confusion of all of the above.
- As the leading consultant in integrated circuit technology, ICE knows a company is ruled by Black Magic only if it allows itself to be. Knowledge is the only way to defeat this Black Magic syndrome.

ICE 1-DAY SEMINARS  
COMPUTER-AIDED DESIGN  
PRODUCT ANALYSIS  
RELIABILITY  
MOS LAYOUT  
MANAGEMENT  
PURCHASING/MARKETING  
LSI TECHNOLOGY  
STATUS OF IC INDUSTRY  
ICE 1 1/2 DAY SEMINAR  
FAILURE ANALYSIS  
ICE 4-DAY ENGINEERING SEMINAR

FOR COMPLETE INFORMATION  
CIRCLE READER SERVICE 505

ICE 2-WEEK SEMINAR  
INTEGRATED CIRCUIT PROCESSING

FOR COMPLETE INFORMATION  
CIRCLE READER SERVICE 504

ICE 4-WEEK SEMINAR  
INTEGRATED CIRCUIT  
DESIGN & FABRICATION

FOR COMPLETE INFORMATION  
CIRCLE READER SERVICE 506

For complete information on ICE consulting services, please write to Mr. William G. Farrow, Executive Vice President.

# ICE®

**INTEGRATED CIRCUIT ENGINEERING CORPORATION**  
4900 EAST INDIAN SCHOOL ROAD/PHOENIX, ARIZONA 85018  
PHONE (602) 959-4760/TWX (910) 950-1285/CABLE ICE PHOENIX

## ... next: a similar probe to test monolithic IC's ...

and moved easily.

This freedom of movement means the probe can be set up quickly, eliminating the need for coarse x-y adjustments. According to Gunter Erdmann, MPM's president, the probe can be just as accurately positioned as the x-y axis type—to within 0.005 inch or better, using a microscope.

The probe needle's z-axis, which has a movement range of 1/2 inch, is controlled by a screw on top of the needle arm. Since the fit between the probe and needle arm is not close, Erdmann says, they won't bind even if silicon dust gets between them.

The contact pressure of the MP-100's needle is adjustable, and

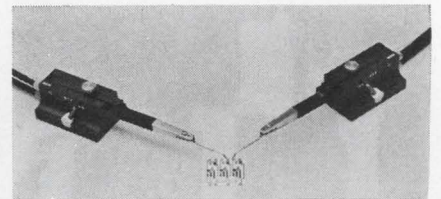

**In place.** Probes are held to bench by a vacuum as they test resistance values on circuit.

its range depends on the unit to which it is attached. Erdmann figures that 40 psi is probably the maximum pressure; any higher pressure might bend the needle. The air-pressure scheme automatically adjusts needle pressure to substrate surface irregularities so the needle's contact pressure is always uniform. Other probes have immovable needles and their pressure on the substrate fluctuates with surface variations.

MPM is working on plans for a two-tip Kelvin probe and one designed for testing of monolithic integrated circuits.

The mini-probe can plug into almost any measuring unit but requires the addition of a vacuum pump. Orders are filled in one to three weeks. The probe costs \$62 for 1-5 units, \$58 for 6-20 units, and \$52 for 21-100 units.

MPM Corp., 7 Harvey Street, Cambridge, Mass. 02140 [429]



*It takes a while  
to achieve excellence*

*It takes forever  
to maintain it*

*Excellence is a complex thing, composed of many parts. It isn't achieved overnight . . . not by anything or anyone. We've devoted almost fifty years to developing the complete line of Markel insulating sleeveings, wire and cable . . . a total of some 3,500 different types and sizes. Each was painstakingly perfected to meet specific needs. It also took a lot of work to design the processes and equipment to manufacture these products in volume to sell at reasonable prices. In addition, we've built and trained an outstanding sales organization to make Markel products and know-how readily available to you. Over the years, Markel products and service have earned a solid reputation for excellence. But we know we have to keep on earning it . . . product by product . . . day by day . . . from now on.*

ONE SOURCE FOR EXCELLENCE  
in Insulating Tubings and Sleeveings  
High Temperature Wire and Cable



L. FRANK MARKEL & SONS, INC., NORRISTOWN, PA. 19404 • PHONE: 215/272-8960

Circle 159 on reader service card



# Photodiode sharpens machine-tool precision

Output is null when light source and segmented diode are aligned; technique eliminates errors of mechanical sensing and gauging

**The positioning** and measurement of holes in engineering assemblies usually is accomplished through mechanical means—and the higher the accuracy required, the greater the risk of error due to material deformation, dirt, and other factors. The same is true of most machine-tool measurement methods, such as shaft eccentricity and face flatness.

A system developed by Integrated Photomatrix Ltd. of England, and marketed in the U.S. by Teknis Inc., uses an entirely electronic, noncontact position displacement measuring system. It substitutes a light beam for the mechanical sensor and a photodiode and electronic signal processing for mechanical gauging.

In this system, a light source is

aligned so that its beam is equally distributed over the four segments of a quartered, photosensitive disk diode. Diametrically opposite segments are connected together so that the disk has two outputs, for x and y coordinates. When the light is equally distributed, the outputs are equal and can be arranged to be a null. If, say, a hole in a substrate comes between light

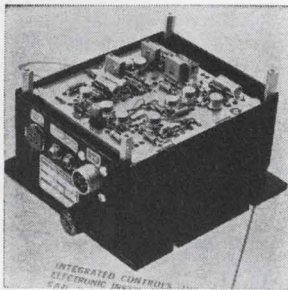

Strain gage signal conditioner model BA04 has integral transducer excitation. It features continuously variable zero and gain controls allowing the conditioner to amplify either 1, 2 or 3 mv/v strain gage signals into a 10 v full scale output. Gain Accuracy is better than 70 ppm/°C. Unit measures 4 x 5 x 3.2 in. Integrated Controls Inc., P.O. Box 17200, San Diego, Calif. [401]



Modular solid state over-energizer applies full a-c line voltage to the load for one second. The load voltage then drops to a lower, adjustable level. This level is maintained until power is shut off. Unit recycles automatically when power is applied. Steady state rating is 5 amps. Price is \$16; delivery, stock to 4 weeks. Greentron Inc., Box 10195, Greenville, S.C. 29601 [402]

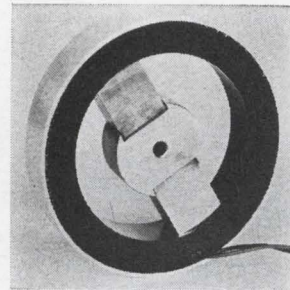

Brushless d-c torquer CZ0 9604 008 is designed to eliminate slot ripple completely. Performance characteristics include:  $\pm 32^\circ$  angular range; 9 oz in. continuous torque; 500 ma input current for max. torque; 18 oz/amp torque sensitivity; and  $-55^\circ$  to  $+100^\circ$  C temperature range. The Kearfott Division of Singer-General Precision Inc., 1150 McBride Ave., Little Falls, N.J. [403]

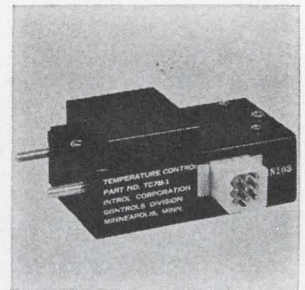

Scr temperature controller model TC7B-1 operates on the zero switching angle principle and significantly reduces rfi. Unit has full wave output and a power capability of up to 1 kw. Output is designed for 4-wire connection to the sensing element and heater. The TC7B-1 measures  $1\frac{3}{4}$  x  $4$  x  $2\frac{1}{2}$  in. It operates from 115 v a-c, 60 hz. Intrrol Corp., 5555 W. 78th St., Minneapolis [404]



A-c controller is designed for 3-phase, fractional h-p motors, and was developed primarily for the computer peripheral device market. It provides arcless make and zero current break. These attributes reduce rfi and emi to levels where equipment drive motors can be operated adjacent to low level logic circuits. Hamlin Electronics, 3879 N. 28th Ave., Phoenix 85017 [405]

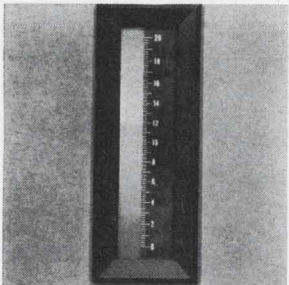

Vertical-scale ribbon indicator model 65 PP-OHN enhances the indication readability of temperature and level applications. Features include an easy-to-read graphic scale, with an optical projection system that virtually eliminates parallax problems. The unit, which is self-contained for flush panel mounting, is  $6$  x  $2\frac{9}{32}$  in. Accuracy is  $\pm 2\%$ . The Foxboro Co., Foxboro, Mass. [406]

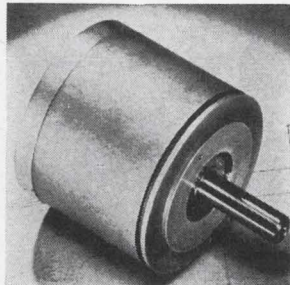

Precision direct drive torque motor model H1937D-185 provides 20 oz. in. peak torque, yet costs less than \$50 in quantity. It is designed for reliable performance as a drive or positioning motor in X-Y plotters, data printers, tape recorders or business machines. Electrical time constant is 0.0004 sec. Vernitron Corp., 21001 Kittridge St., Canoga Park, Calif. 91303 [407]



Bidirectional counters come in single- and multi-axis units. Featuring all-TTL integrated circuitry on plug-in IC cards, they offer high noise immunity for industrial environments and high-speed capability as well. Applications include position or speed measurement and control for machines, and numerical and process control systems. Data Technology Inc., Watertown, Mass. [408]



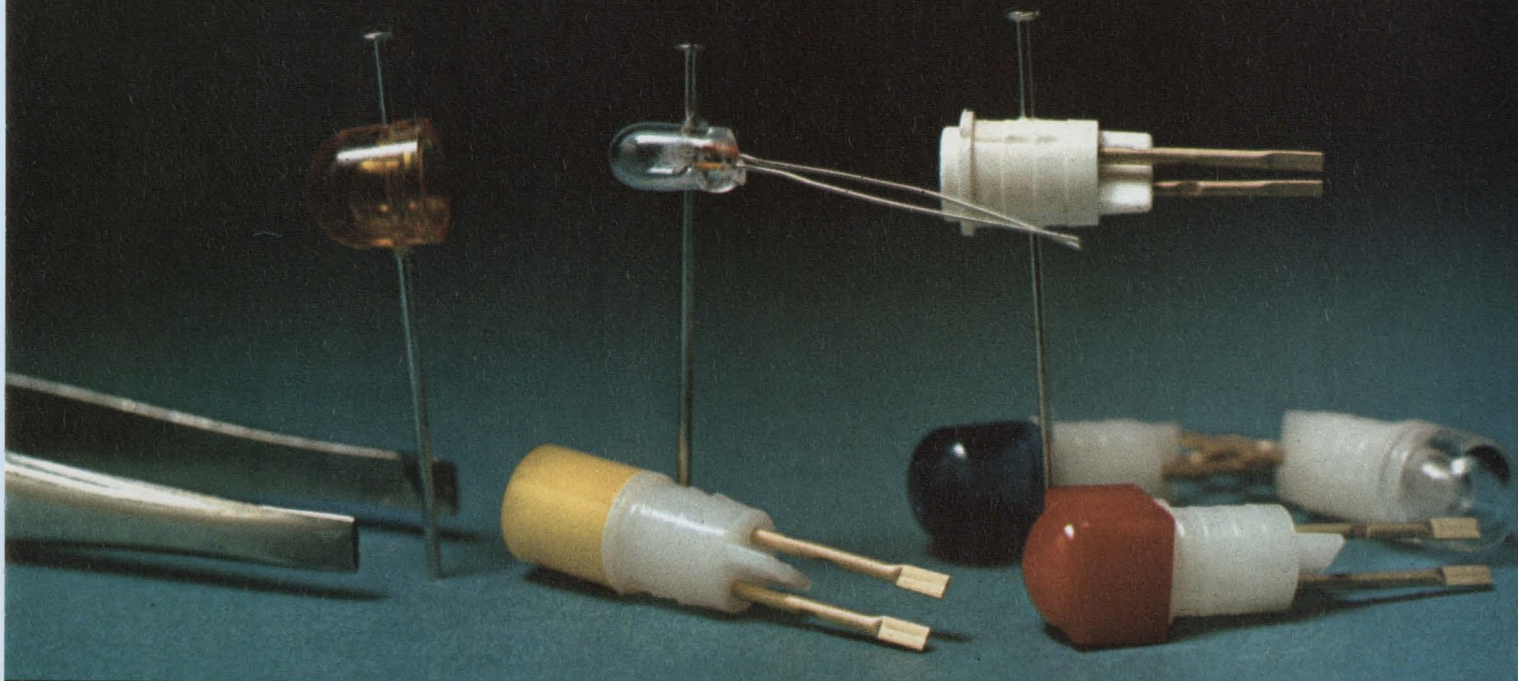

Relamping is simple with Chicago Miniature's CM-25 "Brite-Lites." No tools are required. You merely unsnap the cap and remove the unbased T-1 lamp with your fingers. Our engineers devised an ingenious way to simplify lamp insertion, too. The new lamp easily inserts into internal wire lead guides. The lead guides are indented (patent pending) to assure positive contact with the lamp leads. There's no need for lead soldering. Relamping is all done from the front of the panel, so base removal is unnecessary.

Here's another engineering exclusive close plus and minus tolerances.

Holding tight tolerances improves parts interchangeability and panel appearance. Also, "Brite-Lites" are available with cylindrical caps that can be easily hot stamped with legend information.

These "Brite-Lites" mount on .250" centers and have a strong polycarbonate base with leads for panel or printed circuit wiring. You can specify any of six different cap colors in translucent or transparent types.

Our Lited Devices catalog CML-2 gives details on our complete line of quality indicator lamps, just circle the reader service number to receive your copy. Write on your company

letterhead to receive a sample "Brite-Lite" so you can dissect one yourself.

For application assistance contact your Chicago Miniature Sales Representative. For off-the-shelf delivery, contact your local authorized Chicago Miniature Electronic Distributor.



CHICAGO MINIATURE  
LAMP WORKS  
4433 N. Ravenswood Ave.  
Chicago, Illinois 60640  
(312) 784-1020

a GENERAL INSTRUMENT company

**THE LIGHTING BUGS**

# How to dissect a lighting bug.



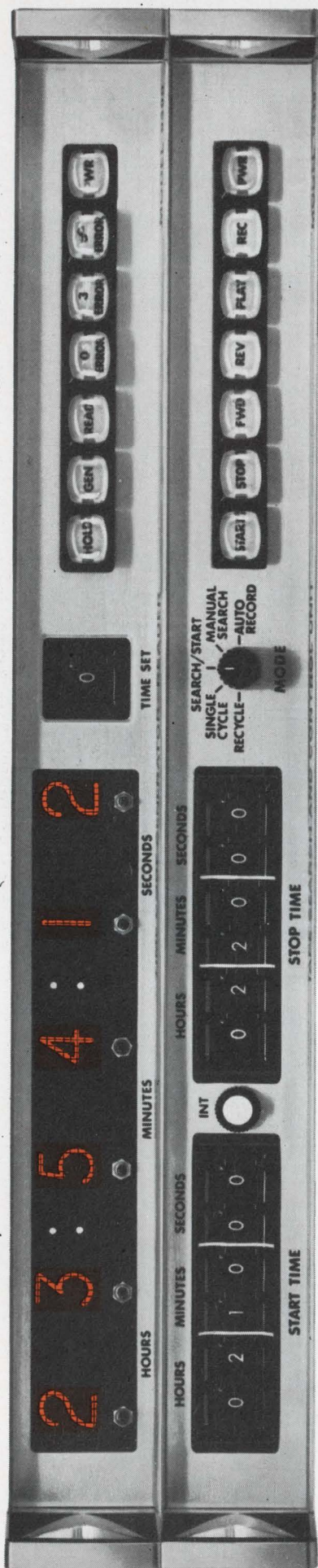

**Now: A True  
Tape Search  
and Control  
System in  
3½ Inches.  
\$3695  
FOB Anaheim.  
Delivery: Two Weeks  
(or sooner)**

Automatic tape search in *both* directions with this new time code generator and tape search and control system from Datum.

This complete system provides time generation for data acquisition, time reading for data playback, and fully automatic tape search for automatic data reduction — all in 3½ inches.

Modular IC construction permits many optional features, such as slow-code outputs, remote display, remote manual control, and high-accuracy time base.

For complete information about the Datum 9300/9420 Tape Search/Control System, or other timing instrumentation, circle the reader service number below, or write: DATUM, INC., Timing Division, 170 E. Liberty Avenue, Anaheim, California 92801. Telephone Number (714) 879-3070. TWX Number (910) 592-1289.

... most jobs will require adaptations of system ...

source and diode, the output will still be null if the hole is correctly positioned; if it's not, the light distribution across the segments will be unequal and the outputs will change in quantity and sign according to the degree of off-center.

In the system, called IPL 30, the diode is repetitively charged and sampled, and the samples are converted to digital form by metal oxide semiconductor integrated circuits alongside the diode on the same substrate. Digital conversion permits transmission over long feed lines to the main processor, which also contains controls and power supplies. There are two pulse trains, one for each pair of diode segments. The signals are square waves and the mark/space ratio of a waveform corresponds to the ratio in which light is shared between the two diodes that feed that pulse train. This information is processed and converted to a single d-c analog output.

The output is zero for null output from the diode, and  $\pm$  up to 12 volts for deviation along either axis. Because it depends on ratios of light level across the diode, changes in absolute light level are not significant over a range of 20 to 1, according to Peter Noble, managing director of IPL.

The size of the light spot can be varied according to the dynamic range and sensitivity required. For instance, a 0.005-inch-diameter spot will give 0.5 micron accuracy but a dynamic range of only about  $\pm$  100 microns, while a 0.06-inch diameter spot will give lower accuracy but a dynamic range of about  $\pm$  0.05 inch. The company has an experimental setup in which a 0.01-inch spot gives a sensitivity of  $\pm$  1 micron over a dynamic range of 200 microns.

The basic system uses one diode and costs \$1,040 in England. Noble thinks that most systems will be custom extensions of the basic system. A typical five-diode system will cost about \$5,000. The technique will be demonstrated at the IEEE Show, Booth 3B30.

Teknis Inc., Plainville, Mass. 02762 [409]





# ELECTRONIC CONTROL SYSTEMS

## DATA LOGGERS

(manufactured under HOKUSHIN License — JAPAN)

- TRANSISTORIZED
- ACCURACY
- RELIABILITY
- LITTLE POWER CONSUMPTION
- EASY OPERATION
- EASY MAINTENANCE
- DESIGNED FOR INTEGRATED AUTOMATION

### GENERAL SPECIFICATIONS

- Unified signal 2... 10, 4... 20, 0... 5, (Input—Output) 0... 10, 0... 20 mA etc.
- Load resistance 0... 3 Kohms
- Ambient temperature —10°... +60°C (for field instruments)  
—10°C... +45°C (for panel instruments)
- Power supply 200 or 220 V (+10... —15%) (A.C. or 60 c/s)

### ELECTRONIC CONTROL SYSTEMS INCLUDE:

- Temperature transmitters with
  - thermoresistance (—200... +500°C)
  - thermocouples (0... +1600°C)
  - radiation pyrometer (+600... +2000°C)
- Pressure transmitters with
  - bourdon tube (0... 350 kgf/cm<sup>2</sup>)
  - capsule (0... 1 kgf/cm<sup>2</sup>)
  - bellows (0... 1000 mm Hg)
- Differential pressure transmitters with
  - bell (0... 100 mm H<sub>2</sub>O)
  - bellows (0... 400 mm H<sub>2</sub>O)
  - bellows (0... 35000 mm H<sub>2</sub>O)
- Area type flow transmitters: 0, 24... 54, 94 m<sup>3</sup>/h
- Electromagnetic flow transmitters: 0, 41... 1770 m<sup>3</sup>/h
- Displacement type liquid level transmitters: 0... 2000 mm
- pH transmitters: 0... 12 pH
- Water quality psychrometer, mol. ratio concentration transmitters
- Miniature indicators
- 120 and 250 mm scale one and two point recorders
- Multipoint (2, 3, 6, 12) recorders
- Calculators and accessories: square root extractors, multipliers, dividers, adders-subtractors setters, program setter, integrators, signal limiters, manual control stations etc.
- Controllers
  - (PI-PID) with and without indicators
  - Multipoint on-off controllers
  - Relay amplifiers

# MASINEXPORT

Bucharest Matei Millo 7  
Cables: MASEXPORT — Bucharest  
Telex: 216

# STATE OF THE ART SEMINARS FOR ENGINEERS AND SCIENTISTS

Here's an opportunity to engage in short programs that will review many of the latest advances and engineering techniques in your field ... presented by RCA Institutes.

LOGIC DESIGN	San Francisco	4/6-10
	Los Angeles	4/13-17
	Syracuse, N. Y.	4/27-5/1
	Houston	5/4-8
	Huntsville, Ala.	5/11-15
	Minneapolis	5/18-22
	Washington, D. C.	6/1-5
DIGITAL SYSTEMS ENGINEERING	Chicago	6/15-19
	Albuquerque	7/27-31
	Dallas	4/13-17
	Washington, D. C.	4/27-5/1
	Cleveland	5/11-15
	Boston	5/18-22
	Montreal	6/1-5
DIGITAL COMMUNICATIONS	Denver	6/22-26
	Washington, D. C.	7/13-17
	New York	4/6-10
	Chicago	4/20-24
	Albuquerque	5/18-22
	Houston	6/1-5
	San Francisco	6/15-19
INTEGRATED CIRCUITS	Los Angeles	6/22-26
	Huntsville, Ala.	7/6-10
	Minneapolis	7/13-17
	Syracuse	7/27-31
	Boston	4/13-15
	Atlanta	4/20-22
	New York	5/11-13
San Francisco	5/20-22	
DIGITAL COMMUNICATIONS	San Diego	5/25-27
	Detroit	6/8-10
	Rochester	6/29-7/1
	Montreal	7/6-8
	Houston	7/13-15
	Pittsburgh	7/27-29

Above schedule subject to change.

## RCA

RCA Institutes, Inc. Dept. E-30  
Institute for Professional Development  
Central & Terminal Avenues, Clark, N. J. 07066

For free descriptive brochure, please check the seminar in which you are interested.

- Logic Design     Integrated Circuits  
 Digital Communications     Digital Systems Engineering

Name \_\_\_\_\_ Title \_\_\_\_\_

Company \_\_\_\_\_

Address \_\_\_\_\_

City \_\_\_\_\_ State \_\_\_\_\_ Zip \_\_\_\_\_



# If your product has to be cleaned completely, safely, efficiently, you should be using FREON<sup>®</sup> cleaning agents.

## Here's why...

- 1. Low boiling point (under 120° F)** for low-temperature vapor degreasing. Eliminates cooling time for post-cleaning processes...no damage to heat-sensitive parts. Minimal heat passed into work environment.
- 2. High density combined with low surface tension** evacuates soil from pores, crevices and cracks—floats away contaminants.
- 3. Clean without damage.** Compatible with widely used materials of construction. Clean completed assemblies instead of individual parts.
- 4. Chemically pure and stable.** No acid acceptance and scratch tests necessary. No inhibitors needed. Parts dry residue-free.
- 5. Safe to people,** as well as to material—nonflammable, nonexplosive, low order of toxicity.
- 6. Lower overall cleaning costs possible.** FREON solvents are recoverable for reuse indefinitely. Very low power requirements in vapor degreasing because of a low heat of vaporization. Better cleaning results in fewer production rejects.

Du Pont FREON cleaning agents have been used to solve critical cleaning problems in the electronics and aerospace industries for many years. If you have a critical cleaning problem, or are looking for a better cleaning system, write today to Du Pont Company, Room 8703-G, Wilmington, Delaware 19898.





# Logic interface IC is multipurpose

Chip containing two NAND gates and two transistors can drive lamps, relays or memories, or function as a switch

When a relay, solenoid, lamp or low-impedance transmission is driven by an integrated circuit, a power transistor usually is needed in the circuit—the IC alone can't supply the current that the driven device needs. Now, however, a monolithic IC is available that contains driver transistors as well as logic gates; with up to 500 milliamperes available from the SN75450,

external driver transistors aren't needed in most applications.

The manufacturer, Texas Instruments, calls the new IC a multipurpose interface circuit, a title intended to convey the wide range of possible uses. Besides driving relays, solenoids, lamps or transmission lines, the SN75450 can be a gated comparator, floating switch, MOS driver, film-memory driver or

core-memory driver, among many other uses.

The chip contains two NAND gates and two transistors. The gates are conventional transistor-transistor logic types; they operate from a +5-volt supply with a typical propagation delay of 10 nanoseconds and an average power dissipation of 10 milliwatts per gate. Input and output character-

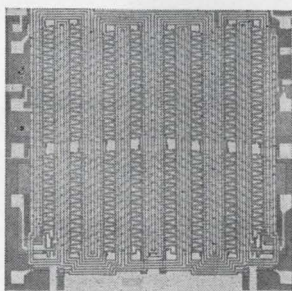

Dual 100-bit static shift register 3307 operates well in a high-noise environment and provides 200 bits of storage at frequencies up to 1 Mhz. It is designed for a power drain of 1.5 mw per bit. In a 1-Mhz unit, with an operating temperature range of -55° to +85°C, price is \$36 each in quantities of 1 to 24. Fairchild Semiconductor, 313 Fairchild Dr., Mountain View, Calif. [436]

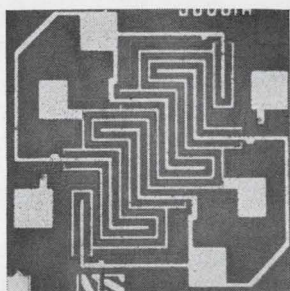

Monolithic, N-channel, dual FET's series FM3954 are matched by design. They eliminate difficulties in matching and testing individual dice by integrating both transistors on one chip. Features include close tracking regardless of bias point, from 50  $\mu$ a to 500  $\mu$ a, leakage of 100 pa, and gain of 1,000  $\mu$ mhos. National Semiconductor Corp., San Ysidro Way, Santa Clara, Calif. [437]

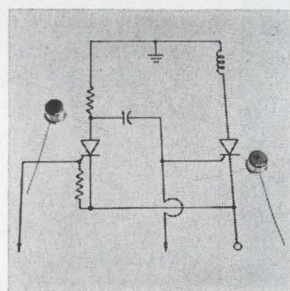

Power gate turnoff RTGD02 uses planar technology. It offers turn-off gain greater than 10 at 5 amps without sacrificing on-triggering sensitivity. Typical turnoff time at 5 amps is 2  $\mu$ sec. The series is specified for operation to +125°C and is available in ratings from 60 to 400 v; it can withstand surges to 60 amps. Transistron Electronic Corp., 168 Albion St., Wakefield, Mass. [438]

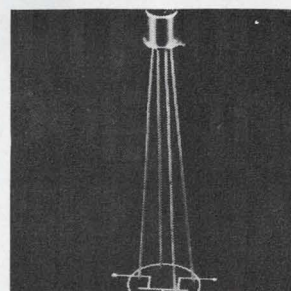

High frequency FET's types 2N4416 and 2N4416A are for vhf amplifier and mixer applications. They feature high power gain (10 db minimum at 400 Mhz), low noise figure (4 db maximum at 400 Mhz), and low output capacitance (0.8 pf maximum). The 2N4416A has a 35-v rating; the 2N4416, 30 v. Crystallonics, a Teledyne Co., 147 Sherman St., Cambridge, Mass. 02139 [439]

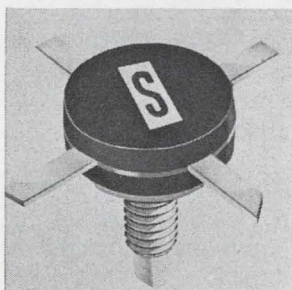

R-f power transistor SRD54117 can deliver 60 w output power at 150 Mhz with 28 v  $V_{CB}$  and a minimum 6 db gain. It can also deliver 50 w of output power at 175 Mhz with a minimum of 6 db gain. The device guarantees a 3:1 vswr capability. It is for use in vhf communications systems. Price (1-99) is \$66. Solitron Devices Inc., 1177 Blue Heron Blvd., Riviera Beach, Fla. [440]

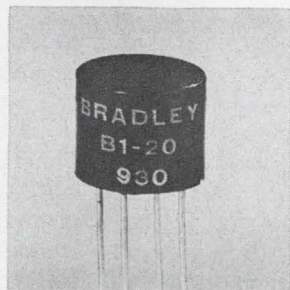

Encapsulated silicon bridge rectifiers series B1 are rated at 1.5 amps and are available in voltage ratings of 50 to 1,000 piv. They are intended for rapid insertion into p-c boards. Units save the user the time and expense of selecting and matching individual diodes for piv, forward voltage drop, and leakage current. Bradley Semiconductor Corp., 275 Welton St., New Haven, Conn. [441]

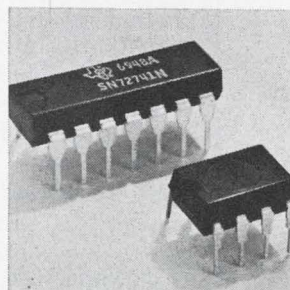

Operational amplifier IC designated SN72741 is short-circuit protected, and the internal frequency compensation provides high stability without the need for external components. High common mode input voltage and absence of latchup suit it for voltage follower applications. Power dissipation is typically 50 mw. Texas Instruments Inc., P.O. Box 5012, M/S 308, Dallas 75222 [442]

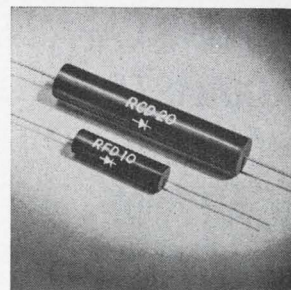

High-voltage silicon rectifiers series RCD-RFD have a piv of 8,000 to 45,000 and a recovery time of 300 nsec. They are rated at a forward current of 20 ma. Applications include power sources of crt's, data displays, radar displays, and r-f supplies where h-f sine-wave, square-wave or pulse inputs are used. Electronic Devices Inc., 21 Gray Oaks Ave., Yonkers, N.Y. [443]



# DATAPLEXERS

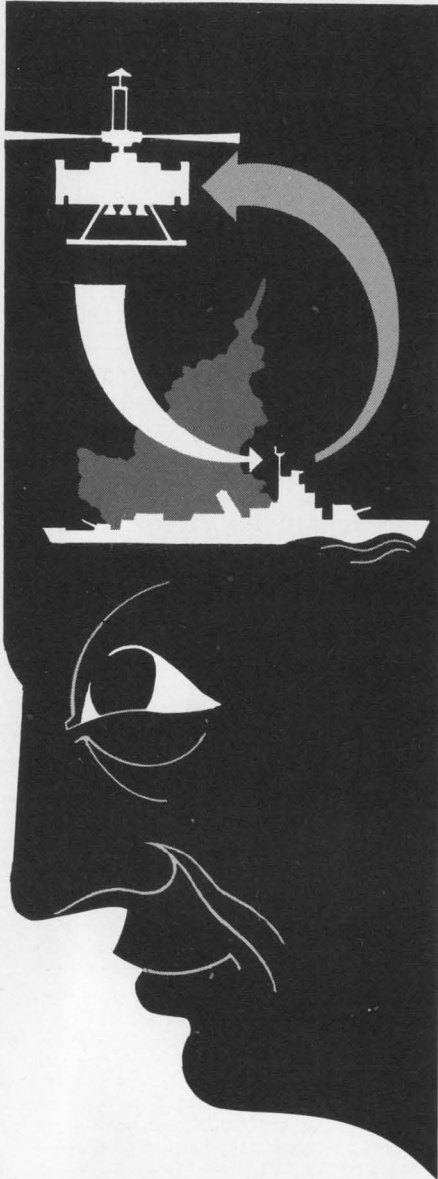

TOTAL ELECTRONIC  
SYSTEMS CAPABILITY.  
SPECIALISTS IN  
TIME/FREQUENCY,  
RADAR AND  
DATA SYSTEMS  
OFFERING RAPID  
GROWTH.



166 Circle 166 on reader service card

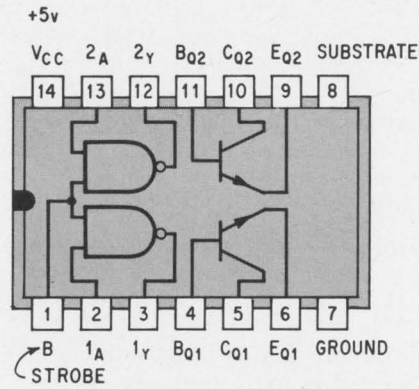

POSITIVE LOGIC:  $Y = \overline{AB}$

**Versatile.** At right are examples of how gates and transistors on chip (above) can be interconnected.

istics are similar to those of TI's series 74 TTL integrated circuits. The gates are connected to each other on the chip by way of a common "strobe" terminal.

Each of the two transistors can handle 250 milliamperes at a saturation voltage of 400 millivolts. The transistors are uncommitted; that is, they are not connected to each other or to the gates on the chip. The only access to them is by way of the package terminals. This is why the circuit has so many uses—the gates and transistors can be interconnected in numerous ways to perform various functions. For example, the base of a transistor can be driven directly by the output of one of the NAND gates. With the emitter grounded in this configuration, a low-impedance path is provided for adding or removing charge when the transistor is turned on or off. As a result, the transistor has very short turn-on or turn-off delay—about 17 nsec. This configuration also makes it possible to operate at collector-to-emitter voltages that exceed the collector-emitter breakdown voltage rating of the device.

**Share same chip.** And because the transistors share the same monolithic chip, their characteristics are similar and they track each other well under varying conditions. It's possible, therefore, to connect the transistors in parallel to get 500 ma output.

Other circuit arrangements:

- ▶ External resistors to limit base current.
- ▶ Zener or pnp transistors between the gates and the transistors to shift voltage and current levels.

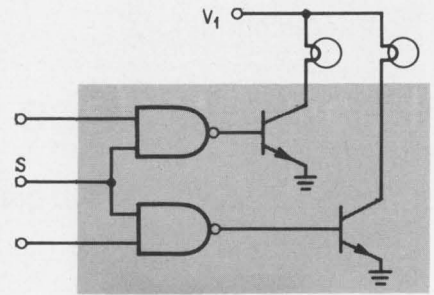

DUAL LAMP DRIVER

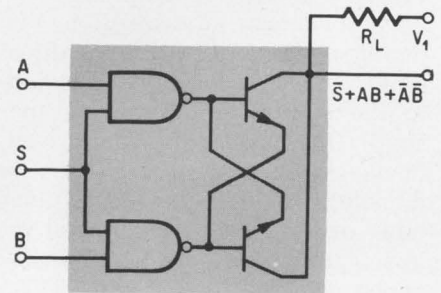

GATED COMPARATOR

- ▶ Darlington or comparator connection of the transistors.
- ▶ Power totem-pole connection.

The silicon chip for the SN75450 is 50 by 50 mils. It's contained in a 14-pin plastic dual in-line package. The pin assignments are intended to give maximum convenience in laying out the circuit board to hold the IC. Power supply and ground go to the corner pins (14 and 7), for example, and the gate output pins are adjacent to the transistor base pins since many applications require direct connection of these terminals. Similarly, the emitter, ground, and chip substrate pins are grouped since they are often interconnected.

**Different.** Unlike most TTL circuits, the substrate of the SN75450 isn't internally connected to ground. Instead, the substrate can be connected to the most negative d-c voltage available, to provide improved isolation of the components on the chip.

TI will follow the SN75450 with an eight-pin variation that has the transistors internally connected to the gates.

Price of the SN75450 is \$2.25 each in 100-unit quantities. It's available from distributors' and manufacturer's stock. Delivery time is two weeks.

Texas Instruments Incorporated, Inquiry Answering Service, P.O. Box 5012, MS 308, Dallas, Texas 75222 [444]



# Pick of the Crop!



## Brand New - The NLS Series MX-2 Multimeter

This is a *PEACH* of a buy. The MX-2 combines multifunction capability with the integrating technique of A/D conversion in a low-cost, versatile, accurate unit with stability unequaled in low-cost digital meters. And you receive all of this without sacrificing the quality feature of plug-in construction. The MX-2 affords 5 DC Ranges, 4 AC Ranges, 5 Ohms Ranges, Auto Ranging and Polarity and Print-out, all at a price so low you'll want to buy a *PEAR*

of them. Send for our brochure which graphically compares the MX-2 to other low-cost 4-digit Multimeters in a factual, easy-to-understand manner. Non-Linear Systems, Inc., P.O. Box N, Del Mar, Calif. 92014, 714/755-1134. TWX 910/322-1132.



**NON-LINEAR SYSTEMS, INC.**  
**DEL MAR, CALIFORNIA**





**The things we do to stay in front!**

**Because we're No. 1 in control knobs . . .**

**and because we're Rogan**

Our reputation means a lot to us. So much in fact that the knobs we make are quality knobs . . . knobs that are "out in front" with "real design appeal" —yet priced right to fit your budget. Write today for free New color catalog

**Rogan**  
BROTHERS, INC.  
8031 N. MONTICELLO AVE.  
SKOKIE, ILLINOIS 60076  
PHONE: (312) 675-1234  
Visit Booth 1C 19 IEEE Show

Circle 186 on reader service card

# DIGITAL TV



CVI video sampling instruments allow your computer to "look" at practically anything. High accuracy bandwidth compression of conventional television signals opens new doors to data processing in research and industrial applications. Let us tell you about some of our unique video devices.

COLORADO VIDEO, INCORPORATED  
P.O. Box 928 • Boulder, Colo. 80302 • Phone (303) 444-3972

# cv*i*

Video Data Acquisition • Processing • Display • Transmission

168 Circle 168 on reader service card

New materials

## Glass protects silicon devices

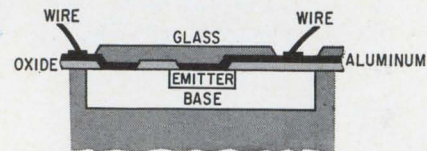

Passivation glass designated IP550 increases the performance and reliability of planar silicon devices. It can be applied either as a frit or as a target for sputtering. Application of the glass decreases leakage initially, and the lifetime gettering action results in further improvement. Also, tweezer scratches and deleterious ambients such as fluxes and ionic impurities can't penetrate the passivation barrier. The combination means higher yields, better performance specs and increased reliability. Production quantities are available from stock at \$15 to \$35 per lb. Innotech Corp., 181 Main St., Norwalk, Conn. [490]

Single-component liquid epoxy molding compounds series RX2300 feature a pot life of over six months at 72°F., but cure at a rate of 30 sec. per 1/8-in. thickness at 320°F. The resulting exotherm is less than 40°F. The materials can be compounded to suit almost any encapsulation need, from coils to active semiconductive devices. Rogers Corp., Rogers, Conn. 06263 [491]

Polyether urethane system EN-1554 is for potting, molding and encapsulating. The two-part resin system is designed for use on harness breakouts, water-tight electrical connectors, cables and cable end seals. It has also proved effective for the potting and encapsulating of printed circuitry and other electrical components. Conap Inc., Allegheny, N.Y. 14706 [492]

Proprietary chemical synthesis techniques are being used to produce an alumina having a 9.999% purity. Used in sputtering targets for thin-film electronic applications, the high purity has significant effect. Particularly important is the lower sodium content achieving more stable electrical properties. Sputtering targets of this purity grade alumina are available in sizes from 3 to 12 in. in diameter by 1/4 in. thick. Price varies according to size, ranging from \$185 to \$1,540. Ceramic Products Division, Materials Research Corp., Orangetown, N.Y. 10962 [493]

Lead molybdate single crystals are striation free, strain free, and optically scatter free. Because of its acousto-optic characteristics, the material can be used in laser deflectors and scanners. Crystal Technology Inc., 2510 Old Middlefield Rd., Mountain View, Calif. 94040 [494]

Electronics | March 16, 1970



# The industrial emergence of Iowa:

122 of America's top 500 companies now operate 457 plants in Iowa.

As World War II ended, the farm states of the Midwest found themselves in a difficult position. Technological and biological advances had made it possible for one farmer to farm more land than ever before. The result — fewer and fewer farm jobs. With the prospect of mass unemployment in the future, Iowa set out to industrialize herself.

Slowly at first, then more rapidly, Iowa's industrial capacity grew as her recruitment methods reached a high level of sophistication. In recent years Iowa trade missions have jetted abroad, seeking new markets for Iowa products. High level brainstorming sessions have produced some startling ideas. A new promotion theme — "Iowa... a place to grow" — has been developed. A contemporary new symbol depicting growth in all directions has been designed. Iowa's dynamic young governor has led groups of Iowa businessmen throughout the nation acquainting industrial prospects with Iowa's advantages. Today Iowa's soaring industrial output exceeds even her enormous agricultural contribution. Among the new industries selecting Iowa sites last year: General Mills and Sara Lee are building plants in the state and Transamerica Corporation is erecting a 20-story office building.

Iowa's biggest asset is her people. Iowa colleges and universities graduate more Ph.D.'s per capita than any other state. Her work force is intelligent, educated and endowed with typical Midwestern pride in work. Personnel Directors privately admit Iowa plants are generally more productive than sister plants in other states.

Iowa has made one of the most successful agricultural-to-industrial transitions in history... adding one while keeping another. In the 1970's, Iowa is truly a place to grow.

## 122 of America's top 500 companies operate 457 plants in Iowa.

### Maybe they know something you don't know . . .

For more information on industrial growth opportunities in Iowa send this coupon.

IOWA DEVELOPMENT COMMISSION  
Dept. E-3, 250 Jewett Building  
Des Moines, Iowa 50309

NAME \_\_\_\_\_

FIRM \_\_\_\_\_

ADDRESS \_\_\_\_\_

CITY \_\_\_\_\_ STATE \_\_\_\_\_ ZIP \_\_\_\_\_

 **Iowa**  
a place to grow

Iowa Development Commission



# Smallest Tubing in the World

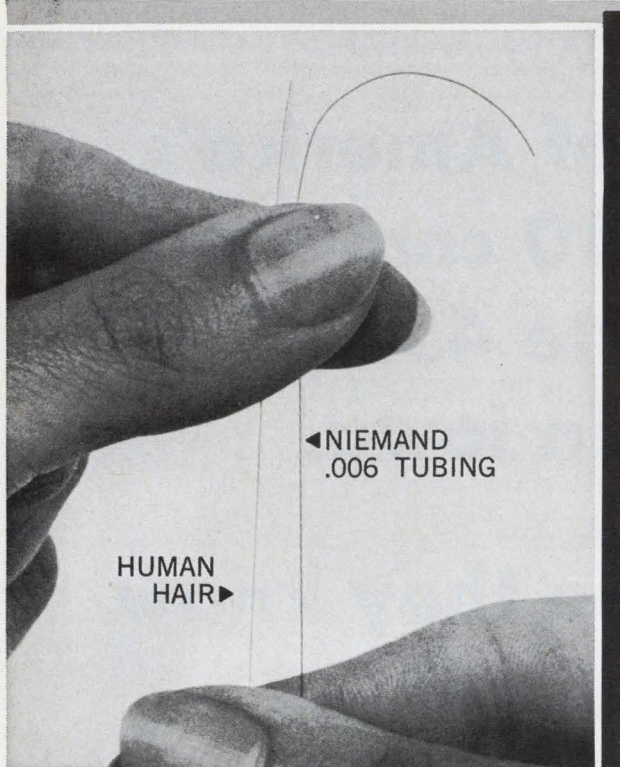

## NIEMAND'S MICRO-ML

I.D.'s from ..... .006" to .020"  
 Wall thickness from ..... .00075" to .001"  
 High heat resistance ..... 300°C  
 Dielectric strength ..... 4,000 volts  
 Non-burning ..... Chars at 850°C  
 Tensile strength ..... 20,000 psi

Made from polyimide polymer, for use as insulation in slip-ring terminations, spacers for high density packing areas in computers, slip-ring assemblies, miniature thermoelectric probes and for wire insulation in high reliability relays. Write or phone for full details and samples.

## NIEMAND BROS. INC.

**NB** TECHNICAL PRODUCTS DIVISION  
 45-15 94th Street, Elmhurst, L.I., N.Y. 11373  
 Tel. (212) 592-2300

Sales Representatives: Atlanta (404) 422-4420 • Burbank (213) 849-6848 • Charlotte (704) 873-6364 • Chicago (312) 539-1820 • Cleveland (216) 247-4245 • Dayton (513) 277-3221 • Denver (303) 777-4381 • Ft. Wayne (219) 447-1158 • Indianapolis (317) 356-3001 • Pittsburgh (412) 823-8310 • St. Louis (314) 965-7650 • Seattle (206) 623-5705

Circle 187 on reader service card

If You Roll 8-Level ASCII for Displays and Terminals . . .

**DON'T BUY**

# ecom D

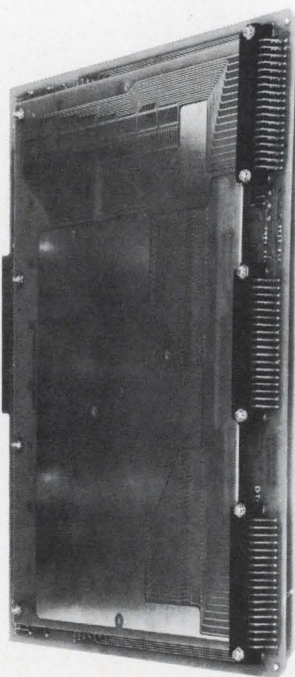
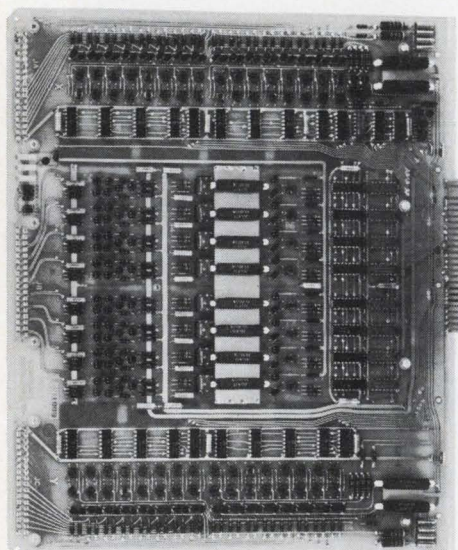

If you just need 1Kx8 . . . we'll charge you \$780! We can send you to at least four sources where you can buy it for \$500! BUT, if you need more memory on the same PC Board with only a single connector — compare:

Their 2K = \$1000 & Their 4K = \$2000  
**ecom D 2K = 858** & **ecom D 4K = 1040**

Ours includes Data Saver and Data Register. Party Line expansion up to 32Kx8.

Write or call the Memory People for Technical Bulletin TB801

## STANDARD MEMORIES

INCORPORATED  
 A Subsidiary of Applied Magnetics Corporation  
 15130 Ventura Boulevard  
 Sherman Oaks, California 91403  
 (213) 788-3010 TWX 910-495-1738



# New Books

## Pcm decoded

Principles of pulse-code modulation  
K.W. Cattermole  
American Elsevier Publishing Co.  
442 pp., \$17.50

The current squabble over worldwide standards for pulse-code modulation systems and the imminence of the digital communications boom are keeping pcm very much in the news. But good tutorial texts on this increasingly relevant modulation technique continue to be rare. This book is one of the lucid few. It's written by a man with years of experience who has 42 patents and papers to his credit, most of them on pcm.

Although the book is aimed at the telecommunications engineer who is not an expert in pcm, it will serve as a reference for specialists. The book presents a clear presentation of the principles and properties of pcm while avoiding cumbersome mathematical complexities. A physical explanation of the subject linking it with general signal theory affords the reader a quantitative appraisal of the performance of pcm with emphasis on the conversion between analog and digital modes of transmission.

For example, a chapter on quantizing looks at the discrepancies between an analog waveform and its quantized counterpart—quantizing noise. The subject of logarithmic quantizing is thoroughly covered; the reasons non-uniform quantizing is preferred over uniform quantizing are presented with emphasis on telephone transmission. All aspects of the signal-to-noise ratio with logarithmic companding laws are laid out in a clear and concise manner, and the differences between companding laws are tabulated.

The spectral distribution of quantizing noise is set forth on a general basis and then applied to different multiplexing techniques. Optimum quantization is covered to allow the reader to either minimize the noise or maximize the information content of an encoded signal, while the section on errors and irregularities in quantizing will

permit evaluation of the more common causes of signal perturbation. The sections on idle channel noise and the quality of quantized speech will be of particular interest to engineers concerned with evaluating overall quality in pcm channels.

Another chapter looks at important subject of coding. Here the diversity of codes and encoding mechanisms are presented. Weighted, unit-distance, symmetrical, and chain codes are described, while the encoding techniques listed include matrix, folded type, sequential, hybrid, and equilibrium. The section on code translation concerns itself with the determination of a single code from several different ones in a single communications system.

Still another highlight is the chapter on signal sampling. It extends from general ideas, such as sampling switches and sampling modulation, to time-division multiplex and pulse width modulation. The effects of signals with imperfect band limitations is especially applicable to present pcm systems.

And the chapter on the principles and history of pcm is good background material for the telecommunications engineer who is a novice in pulse code modulation techniques and practices.

## Recently Published

**Transistors**, E.J.M. Kendall, Pergamon Press, 332 pp., \$7 hard cover, \$5.50 paper

Keeping in mind the spectacular advances in semiconductor physics of the last two decades, the author travels from a resume of semiconductor physics all the way to a paper describing a new thin-film transistor.

**Transistor Switching and Sequential Circuits**, John J. Sparkes, Pergamon Press, 235 pp., \$5 hard cover, \$4 paper

This volume is intended to help students design, build, and interconnect digital or switching circuits. Explored are the problems of generating the kinds of waveforms needed in digital circuits—principally square waves, ramps, and delays. Also discussed are gates and flip-flops, and how to interconnect them.

# designer's keyswitch



Build your own keyboard by using new ALCOSWITCH Keyswitch Modules. A highly reliable reed and magnet combination is employed to provide extremely long life and a low operating force simulating the action of a fine electric typewriter. Modular switches fit into standard 3/4" centers and have a 10° slanted base for "step up" key formation.

Quantity prices quoted upon request!

Read all  
about it  
in this  
20-page  
catalog!

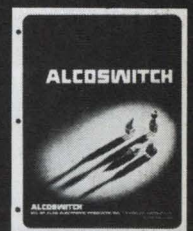

# ALCO®

ELECTRONIC PRODUCTS, INC.  
Lawrence, Massachusetts 01843

See Us at Alco Booth 4G23 IEEE Show



# NEW Thermal Wire Stripper

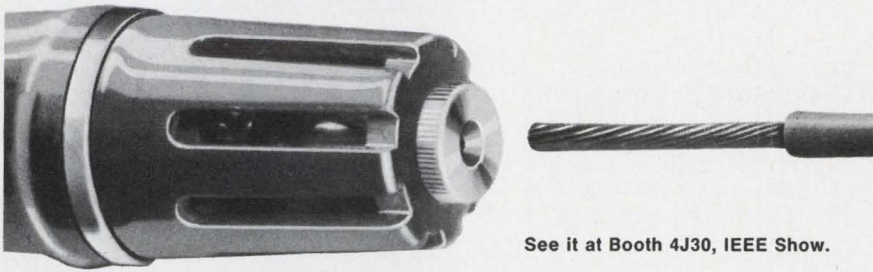

See it at Booth 4J30, IEEE Show.

## can't damage conductors, ever.

Roto-Therm rotary thermal wire stripper. Delicately yet positively applies the thermal element so that even hair-like #40 strands are never nicked. Strips all insulations with ease, including semirigid coaxials, twisted pairs, shielded cable. Control, repeat-



ability, performance so good they wrote the thermal wire stripping specs around Roto-Therm. Write or call today for no-obligation demonstration. Roto-Therm Division, Republic Corporation, 950 No. Sepulveda Boulevard, El Segundo, Calif. 90245. (213) 322-4950.

# REPUBLIC ROTO-THERM

Circle 188 on reader service card

TYPE FEP



**ZIPPERTUBING®  
TEFLON® JACKETING**

for extreme temperature variations —  
minus 425° to plus 400° F!

FEP TEFLON provides low installation cost, and abrasive-resistant jacketing for extreme temperature environments.

In 3 types: Shrinkable, regular and shielded for R.F.I. protection with grounding braid. Sizes 1/2" to 4" (or larger) in 1/8" increments. \*Reg. T.M. of Dupont

For full information on specialized, high-performance jacketing, contact

**THE ZIPPERTUBING® CO.**

**CORPORATE HEADQUARTERS**  
13000 S. BROADWAY  
LOS ANGELES, CALIF. 90061  
Phone (213) 321-3901  
TWX 910-346-6713

BALTIMORE • BOSTON • CHICAGO • CLEVELAND • DALLAS
NEW YORK • ORLANDO • PHOENIX • SAN FRANCISCO • WEST GERMANY



THIS SPACE CONTRIBUTED BY THE PUBLISHER



Photo: O'Neill Miss Raquel Welch

## Learn cancer's warning signals. You'll be in good company.

1. Unusual bleeding or discharge.
2. A lump or thickening in the breast or elsewhere.
3. A sore that does not heal.
4. Change in size or bladder habits.
5. Hoarseness or cough.
6. Indigestion or difficulty in swallowing.
7. Change in size or color of a wart or mole.

If a signal lasts longer than two weeks, see your doctor without delay.

And be sure to have a health checkup once a year, no matter how well you may feel.

**Fight Cancer with a checkup and a check**

## Technical Abstracts

### Spray together, stay together

Electrical generation of collimated beams of uniform charged particles  
Steven B. Sample and Bollini Raghupathy  
Purdue University School of Electrical Engineering  
Lafayette, Ind.

Currently being investigated is a new process for generating collimated beams of nondispersed, uniformly charged particles with diameters ranging from 10 to 500 microns. Such beams, it's expected, might be used to bond one material to another, and to facilitate selective coating or abrading of solid surfaces to within very fine tolerances. This process should find applications in developing integrated circuits, in studying erosion and failure mechanisms of ceramic materials, and in improving tightly bonded coatings on conductive materials.

The process utilizes electric spraying of liquids. Uniform particles are periodically emitted from an electrically stressed meniscus at a capillary tip.

A reservoir of liquid is connected to the thin capillary tube and the tube's d-c potential relative to a ground plane is raised to about 10 kilovolts. The charge induced on the liquid meniscus at the tube's tip interacts with the strong electric field to cause an outward stress on the meniscus. When the stress exceeds the inward-surface-tension stress, the meniscus becomes unstable and streams of charged particles are emitted. Normally, the resulting spray is very random and irregular.

However, under certain conditions of liquid pressure and applied voltage, the spraying process can be made quite regular and periodic. Emitted particles are uniform in size and charge, evenly spaced, and collinear in trajectory.

Application of an a-c potential on top of the d-c voltage improves the collinearity and uniformity of the particles, and can also be used to control frequency of particle emission to some extent.

The major parameters of the process are capillary diameter, pressure on the liquid, and applied



d-c and a-c potentials. Typically, for water—the liquid used during the investigation—capillary outside diameters range from 300 to 710 microns, the liquid-pressure head from 0 to 22 centimeters of water, and d-c potential from 5 to 12 kilovolts. Spraying frequency ranges from about 100 hertz to nearly 1.3 kilohertz. The amount of a-c potential modulation of the electrical stress depends on the value of the d-c potential. Good results are obtained when the a-c potential is about 20% of the d-c value.

While the investigation of this process so far has proceeded with water in an air environment, efforts are under way to study the periodic electric spraying of molten metals and salts in a vacuum.

Presented at NEC, Chicago, Dec. 8-10, 1969.

### Dialing t-e-c-h-n-o-l-o-g-y

New technology components for telephone sets  
Phillip J. Read  
Northern Electric Co. Ltd.  
Ottawa, Ontario

A new telephone set using microcircuit techniques has been developed to lower service costs, relax design limitations on the switched network, and offer the user an improved range of options. The essential components of the telephone set are the transmitter, the push-button tone generator, the tone caller, the hybrid network, and the wiring assembly and housing.

The acoustic transducers used in the new telephone are composed of an electret—solid dielectric capacitor—transmitter, a balanced armature receiver, and a dynamic loudspeaker. The electret transmitter was chosen over piezoelectric, piezoresistive, semiconductor, variable reluctance, and dynamic techniques because it offers ruggedness, low cost, and the best potential for miniaturization. Another electret advantage is that the transfer function from acoustic pressure to electrical signals depends on the characteristics of small sub-areas of the diaphragm, so that sensitivity is not reduced when size is reduced. However, there was a tradeoff—the output impedance of the transmit-

ter was limited to 2 megohms, which in turn limited the size of the transmitter. Transmitter output impedance increases as size decreases, and since a bipolar pre-amplifier was used, the output impedance had to be 2 megohms.

The receiver—a variable reluctance type—replaces the large biasing ring magnet used in conventional receivers with a small bar magnet, the biasing magnetic path was separated from the acoustic signal path to allow independent adjustment. These features were achieved by using a balanced armature technique. The input impedance of the receiver is 600 ohms, but units could be made with the standard 1,500-ohm impedance.

The tone caller had to be designed for maximum penetration and minimum user discomfort. High-frequency tones are disturbing and low frequencies do not attract attention. The signal selected contains two fundamental frequencies, 500 and 600 hertz, each with third and fifth overtones.

The tone caller has four essential parts—it is actuated by receiving a high-power, 20-hz signal which the first part converts into a power source for the later stages; oscillators and multivibrators that generate the tones for the second part; amplification in the third part; and finally broadcast to a loudspeaker.

The design requirements of the hybrid network were stringent. The primary objective of relaxing telephone set limitations on the switched network and the secondary objective of improved acoustic quality ruled out the use of the carbon button transmitter with its high current requirements. An active hybrid network was chosen with enough power gain in the transmit path for the selected transducer and the receive path with its defined sidetone characteristics. The hybrid network provides the same switching function as the common switch of a conventional Touch-Tone dial assembly. And it removes the requirement for timing contact closure—one of the main causes of high cost in older dials as well as a cause of failure.

Presented at NEC, Chicago, Dec. 8-10.

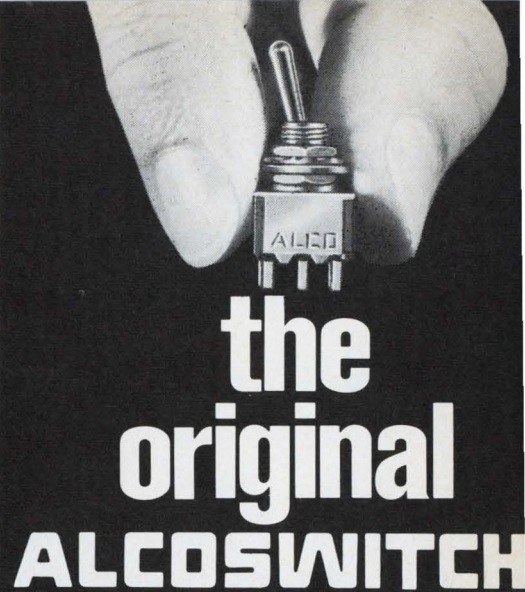

# the original ALCOSWITCH

The original miniature ALCOSWITCH® has been the engineer's 1st choice for contemporary front panel designs.

When most every one was working with conventional switches of the 1930's, ALCOSWITCH® introduced the concept of mass-produced switches compatible with the new technology of miniaturization.

Ultra-miniature in size, the original ALCOSWITCH® combines high current capacity and exceedingly long life into a 1/2" size case. Contacts are solid silver and the phenolic body has high voltage barriers between terminals and contacts.

Since its introduction the original ALCOSWITCH® has withstood the test of time, where today it is the "most-asked-for" miniature switch.

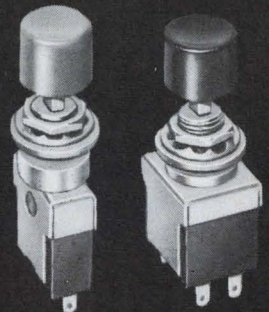

This broad line of miniature switches includes toggles, push buttons and rotaries, all available in one, two, three and four pole in a single case construction.

Read all about it in this 20-page catalog!

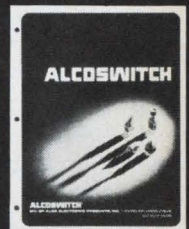

# ALCO®

ELECTRONIC PRODUCTS, INC.

Lawrence, Massachusetts 01843

See Us at Alco Booth 4G23 IEEE Show



The Material  
of Unlimited Uses...



## SOLDERING "UNSOLDERABLES"

...is but one of the thousands of uses for advanced low-melting-temperature alloys such as Cerroalloy® 35. Cerroalloy 35 melts between 238° and 260° F., and can be used with ordinary soldering techniques. When soldered with this versatile alloy, "toughies" such as glass-to-metal, ceramic-to-metal and metal-to-metal seals stay tight even in a deep vacuum. Other Cerro® Alloys, including specials made to your individual specs, are perfect for joining ultra-delicate parts like integrated circuits which cannot be heat-sunk during soldering. Low-temperature soldering as cool as 117° F. can also be accomplished with certain Cerro Alloys.

For detailed information contact Cerro Alloy Dept., Cerro Copper & Brass Company, Bellefonte, Pa. 16823 ... (814) 355-4712.

In Europe, contact Mining & Chemical Products Ltd., Alperton, Wembley, Middlesex, England.

# CERRO®

## New Literature

**Wideband transformers.** Relcom, 2329 Charleston Rd., Mountain View, Calif. 94040. A six-page catalog contains specifications and application material on a line of miniature, wideband transformers.

Circle 446 on reader service card.

**Disk memory system.** Potter Instrument Co., East Bethpage Rd., Plainview, N.Y. 11803. A data sheet describes the DD4314-DC5314 random-access disk memory system. [447]

**Aluminum electrolytics.** Sprague Electric Co., 35 Marshall St., North Adams, Mass. 01247. New performance data on the type 601D Extralytic aluminum capacitors is given in engineering bulletin 3456A, which is available upon letterhead request.

**A/d converters.** Data Technology Corp., 1050 East Meadow Circle, Palo Alto, Calif. 94303. Bulletin 692 describes the six different analog-to-digital converters in the company's 6400 series. [448]

**Chart paper.** Beckman Instruments Inc., 3900 River Rd., Schiller Park, Ill. 60176. Bulletin 663 is an eight-page price catalog listing comprehensive cost and specification data on available precision chart paper for Dynograph recorders. [449]

**Solder brochure.** Bow Solder Products Co., 25 Amsterdam St., Newark, N.J. 07105. A six-page bulletin lists all of the company's various solders and fluxes and provides authoritative data covering both electronic and general industrial applications. [450]

**Dual-gate MOS FET's.** Texas Instruments, P.O. Box 5012, M/S 308, Dallas 75222. Application reports CA-136 and CA-133 evaluate dual-gate MOS FET's in color tv receivers. [451]

**Cermet trimmers.** CTS of Berne Inc., Berne, Ind. 46711, offers data sheet 3165 describing the series 165 Cermet multiturn trimmers for applications requiring a highly stable trimmer of extremely small size. [452]

**IC testing.** Teradyne Inc., 183 Essex St., Boston 02111, has published a 12-page brochure describing the J133C analogical circuit test instrument and a line of accessories. [453]

**Proximity switches.** Electro Products Laboratories Inc., 6125 Howard St., Chicago 60648. Proximity switch bulletin designated PX-969 includes application diagrams, dimensions and specifications. [454]

**Transient suppressor diodes.** KSC Semiconductor Corp., Katrina Road, Chelmsford, Mass. 01824. A technical data sheet provides electrical and mechanical characteristics for a series of silicon voltage transient suppressor diodes rated at 1,500 w peak. [455]

**Coils catalog.** Delevan Division, American Precision Industries Inc., 270 Quaker Rd., East Aurora, N.Y. 14052, has available a full line catalog of molded-variable and molded-fixed coils. [456]

**Power supplies.** NJE Corp., 20 Boright Ave., Kenilworth, N.J. 07033. A 28-page catalog features a line of laboratory and bench power supplies that offer a new concept of regulation by use of accessible plug-in regulator cards in either the voltage or current output modes. [457]

**Power semiconductors.** Mullard Inc., 100 Finn Court, Farmingdale, N.Y. 11735. Information on a comprehensive range of power semiconductors is contained in a 12-page catalog. [458]

**Sense amplifiers.** Silicon General Inc., 7382 Bolsa Ave., Westminster, Calif. 92683. An eight-page booklet describes the 7520/25 series of high-speed sense amplifiers. [459]

**Computer terms.** General Automation Inc., 706 W. Katella Ave., Orange, Calif. 92667, offers a glossary of commonly used computer terms covering the word gamut from "access time" to "zero suppression." [460]

**Radar modulator components.** Capatron Division of AMP Inc., 155 Park St., Elizabethtown, Pa. 17022. Radar modulator components such as pulse forming networks, pulse transformers, modulators, charging reactors and power supplies for airborne, shipboard, and ground support applications are covered in a 16-page booklet. [461]

**Power supply systems.** Lambda Electronics Corp., 515 Broad Hollow Rd., Melville, N.Y. 11746, has available a 32-page catalog describing and illustrating a complete line of standard power supply systems. [462]

**Microminiature connectors.** Continental Connector Corp., 34-63 56th St., Woodside, N.Y. 11377, has issued a 16-page catalog on an expanded line of microminiature rectangular connectors with wire crimp removable or fixed contacts. [463]

**Multimeters.** Dana Laboratories Inc., 2401 Campus Dr., Irvine, Calif. 92664. Eight-page data sheet 1082 describes the series 3800 three-digit multimeters. [464]

**Digital-to-analog converters.** Analog Devices, Pastoriza Division, 221 Fifth St., Cambridge, Mass. 02142, offers a four-page technical paper that discusses digital-to-analog converter parameters and their measurement. [465]

**Hardware.** James Millen Mfg. Co., 150 Exchange St., Malden, Mass. 02148. A 16-page catalog illustrates and describes a line of terminals, plate caps, and sockets. [466]



**Chip capacitors.** Vitramon Inc., Box 544, Bridgeport, Conn. 06601. Data sheet C25A introduces a line of EIA standard size chip capacitors. [467]

**Computer data reduction.** BLH Electronics Inc., 42 Fourth Ave., Waltham, Mass. 02154, has published a new section for its standard semiconductor strain gage handbook entitled "Computer Data Reduction". [468]

**Stock relays.** Magnecraft Electric Co., 5575 N. Lynch Ave., Chicago 60630. A 24-page catalog 271 lists a broad line of 512 different stock relays. [469]

**Doping systems.** HLS Inc., 2576 Lafayette St., Santa Clara, Calif. 95050. Semi- and fully-automated doping systems are shown and described in a six-page brochure. [470]

**Remote terminals.** Data 100 Corp., 4444 W. 76th St., Minneapolis 55435, offers a brochure describing its line of Seventy series terminals for batch or real time operation. [471]

**Videotape recording.** Ampex Corp., 2201 Estes Ave., Elk Grove Village, Ill. 60007. Brochure V69-30 details 52 closed-circuit videotape recording equipment applications. [472]

**Thermoelectric products.** Cambridge Thermionic Corp., 445 Concord Ave., Cambridge, Mass. 02138. A 104-page manual covers the complete line of Cambion thermoelectric products. [473]

**Numeric keyboard.** MicroSwitch, a division of Honeywell, 11 W. Spring St., Freeport, Ill. 61032. A detailed description of the NW1 numeric keyboard is given in a 4-page bulletin. [474]

**Economy transistors.** Texas Instruments, P.O. Box 5012, M/S 308, Dallas 75222. A 12-page brochure CB-111 describing the Silect line of low-cost transistors gives details on plastic-encapsulated silicon bipolar, unijunction, and field-effect devices. [475]

**Digital multimeters.** Dana Laboratories Inc., 2401 Campus Dr., Irvine, Calif. 92664, has issued eight-page data sheet 988 describing the new series 5400 digital multimeters. [476]

**Pressure transducers.** Electro-Science Inc., 1502 W. 34th St., Houston, Texas 77018, has available a leaflet on its new design in pressure transducers that use the latest in IC's with built-in heaters to maintain excellent stability over a wide temperature span. [477]

**Disk storage drive.** Bryant Computer Products, 850 Ladd Rd., Walled Lake, Mich. 48088. Eight-page brochure BCP-1-18109 covers the new 1100 disk storage drive which is totally compatible with the IBM 2311. [478]

**Component socket guide.** Elco Corp., Willow Grove, Pa. 19090. A 16-page guide describes and illustrates a complete line of high-reliability sockets including 14- and 16-pin DIP sockets, transistor sockets, miniature tube sockets, standard and miniature relay sockets, and crystal sockets. [479]

**High-vacuum feedthroughs.** Ceramaseal Inc., New Lebanon Center, N.Y. 12126, has issued 20-page catalog 6910HVF covering ceramic-metal high-vacuum feedthroughs and stainless steel high-vacuum flanges. [480]

**Medium-speed modem.** Tel-Tech Corp., 9170 Brookville Rd., Silver Spring, Md. 20910. Low-cost, medium-speed, compact modem TT-202 is described in a four-page folder. [481]

**A-c relays.** Teledyne Relays, 3155 W. El Segundo Blvd., Hawthorne, Calif. 90250, has available a brochure summarizing the specifications of TO-5 and solid state a-c relays. [482]

**Military connectors.** Elco Corp., Willow Grove, Pa. 19090. A 28-page manual describes 12 types of connectors intended for use in military systems design. [483]

**Differential pressure transducers.** Genisco Technology Corp., 18435 Susana Rd., Compton, Calif. 90221. Operating characteristics of a line of highly accurate, bonded strain gage differential pressure transducers are covered in a technical data bulletin. [484]

**Converter data.** Transmagnetics Inc., 134-25 Northern Blvd., Flushing, N.Y. 11354, has published a single-page data sheet on the series 678 synchro-to-linear d-c converter. [485]

**Industrial information systems.** Electronic Modules Corp., P.O. Box 141, Timonium, Md. 21093. Data acquisition systems for industry are highlighted in bulletin D-1015. [486]

**Dvm compatible printer.** Dytro Corp., 63 Tec St., Hicksville, N.Y. 11801. A two-page product sheet describes the Address-O-Print model 1100, a dvm compatible printer. [487]

**Optical coating facility.** Union Carbide Corp., 2520 Colorado Ave., Santa Monica, Calif. 90406, has released a fact sheet detailing its capability in design, development, and production of multilayer, thin-film coatings for solid state laser components. [488]

**Panel instruments.** Sigma Instruments Inc., 170 Pearl St., Braintree, Mass. 02185. An eight-page brochure contains photos, outline drawings, description and prices on a wide range of round and edgewise panel instruments. [489]

—EMPLOYMENT—  
PERSONALIZED (not computerized) SERVICE

ONE knowledgeable, ethical, service-motivated consultant is more valuable to the job-seeking electronic engineer than a computer and 87 affiliated agencies. Especially when his service is nationwide and employer fee paid.

You write. I'll respond. Then you decide.

JOSEPH P. CORCORAN Personnel Consultants  
5056 Germantown Pike, Lafayette Hill, Pa. 19444  
215/825-0848

CIRCLE 966 ON READER SERVICE CARD

ADDRESS BOX NO. REPLIES TO: Box No.  
Classified Adv. Dept. of this publication.  
Send to office nearest you.  
NEW YORK, N. Y. 10036: P. O. Box 12  
CHICAGO, Ill. 60611: 645 N. Michigan Ave.  
SAN FRANCISCO, Cal. 94111: 255 California St.

POSITION VACANT

**Wanted—Electrical or electronics engineer** with five or more years experience needed to teach in the area of electronics technology. Applicant must have B.S. degree (M.S. preferred). Salary commensurate with qualifications. Excellent future. Send resume to: Dr. A. A. Paloumpis, Dean of Instruction, Illinois Central College, P.O. Box 2400, East Peoria, Illinois 61611.

EMPLOYMENT SERVICE

**Resume Guide—Authentic writing instructions,** clear, examples: \$2. Executive Resumes, Box 246EL, Montclair, N.J. 07042.

BUSINESS OPPORTUNITY

**Capital Contacts—Before you try Public or Private Placements to Underwriters, Investment Banking Houses,** write for helpful information to Confidential Consultant 817 - 51st St., Brooklyn, N.Y.

RESUMES

**The Resume Game: An Insider's Guide.** How to write & use yours successfully. Samples. \$4. Plymouth Pubs, Box 318A, Plymouth Mtg., Pa. 19462.

—SEARCHLIGHT—

LARGEST INVENTORY  
OF U.S. MILITARY  
RADARS IN THE WORLD

TRACKING—SEARCH—AIRBORNE  
WRITE FOR FREE 16-PG. CATALOG



RADIO RESEARCH  
INSTRUMENT CO.

45 W. 45th ST., N.Y., N.Y. 10036  
212-586-4691

CIRCLE 967 ON READER SERVICE CARD

High Quality American Noise  
Measuring Instruments

The following unused, "as new", instruments must be disposed of:—

1. WIDE RANGE TRANSISTOR  
NOISE ANALYZER.

Quan-Tech model 2173C. Suitable for bipolars and FET's. Fully variable supply voltages and currents. Collector voltage to  $\pm 60$ v. Collector current 3 A to 30 mA. Frequency range 10 Hz to 100 KHz.  
(Cost us \$3,260.00) ..... \$1,450.00

2. LINEAR INTEGRATED CIRCUIT  
NOISE ANALYZER.

Quan-Tech Model 2283. Suitable for all flat packs to/or dual in line cases. Supply voltages variable to  $\pm 30$  v. Frequency range 5 Hz to 125 KHz.  
(Cost us \$2,080.00) ..... \$960.00

3. FILTER UNIT

Quan-Tech model 2181. May be used with the Transistor Noise Analyser to provide individual readout of noise voltage at 10, 100 Hz, 1, 10, 100 KHz. Simultaneously all on individual meters.  
(Cost us \$3,228.00) ..... \$1,320.00

HUNTING OILFIELD SERVICES, LTD.  
Main Cross House, Main Cross Road  
Great Yarmouth, Norfolk, England

CIRCLE 968 ON READER SERVICE CARD



# LSI

## The Changing Interface

Medium and large scale integration are slated to have major impact on the electronics industry. The effects are already being felt — not only on systems and component design — but on fundamental, traditional relationships between equipment builders and component suppliers.

Important trends that will affect your profession, your job, your company, are explored in LSI: THE CHANGING INTERFACE, a 100-page illustrated volume published by McGraw-Hill's Electronics/Management Center.

In THE CHANGING INTERFACE, leading design engineers and managers, the men responsible for guiding their companies through the next generation of electronics, discuss the problems that LSI/MSI are stirring up — and offer their solutions.

Here are some of the vital topics covered.

- Implications of LSI on the Electronics Market
- The Rationale for an In-House IC Capability
- The Component Maker's Responsibility vs. the System Builder's Responsibility
- Masks and Computer-Aided Design at the Interface
- The Testing Interface
- How IBM and Bell Laboratories Deal with the Interface Problem
- Controversies and Future Trends in LSI

Copies of LSI: THE CHANGING INTERFACE are available now at \$10 per copy. Fill in and return the coupon below. If you send a check now, we'll pay the cost of postage and handling.

Electronics/Management Center  
330 West 42nd St.  
New York, N.Y. 10036

Attn. Mr. Wayne Cowart

Please send \_\_\_\_\_ copies of LSI: THE CHANGING INTERFACE at \$10 per copy.

Name \_\_\_\_\_ Title \_\_\_\_\_

Company \_\_\_\_\_

Company Address \_\_\_\_\_

City \_\_\_\_\_ State \_\_\_\_\_

- Check enclosed for \_\_\_\_\_  Bill me  
 Bill Company, P.O. Number \_\_\_\_\_

We'll tell you all about our precision photoemulsion and chrome-on-glass masks. Their submicron tolerances. The 1/4 micron repeatability of our master plates. Our ability to handle anything from discretes to LSI to hybrids. Our typical under-two-weeks delivery. And we'll show you how we'll cut your costs, whether you need one mask or thousands.

So put a nickel stamp on a postcard and send us your name and address for all the details.

Or, just use the bingo card and save the nickel. It's a habit we encourage.

Electronic Computer Graphics, 2911 Daimler St., Santa Ana, Calif. 92705.

## For a nickel, we'll show you how to increase your IC yield.

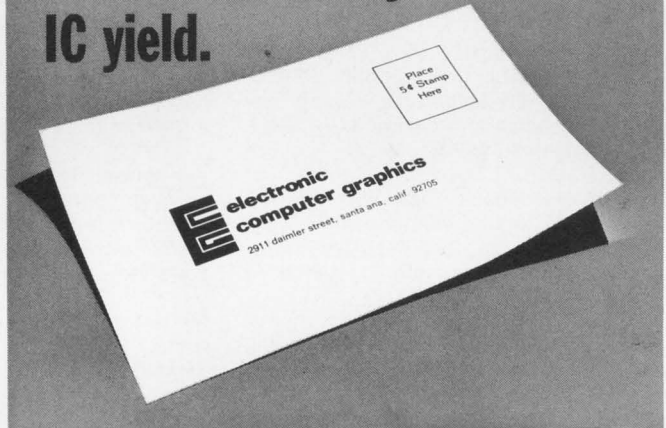

Circle 189 on reader service card

## FORGET EMI

Just Remember LossyLine Flexible Filter!

LUNDY LossyLine Flexible Filter absorbs and dissipates unwanted or spurious electrical energy such as RFI/EMI, harmonics or other "noise." Inexpensive and easy to use. LossyLine requires no grounding, connectors or housing.

- 10 MHz to 100 GHz
- 100 dB attenuation
- 1 mA to 50 A
- 10 to 100,000 Volts
- -67° to +250°C
- 0.5" Minimum bend radius



SEND NOW FOR TECHNICAL LITERATURE

**LUNDY ELECTRONICS & SYSTEMS, INC.**

Glen Head, New York 11545  
516 OR 6-1440 • TWX 510-223-0605



# Electronics advertisers

March 16, 1970

<b>Advanced Memory Systems</b>	144	<b>Farinon Electric</b>	6	<b>National Electronics, Inc.,</b>	27
Fleig and LeBoeuf Adv., Inc.		Jack Herrick Adv., Inc.		Subsidiary Varian Associates	
<b>AEG Telefunken</b>	180	<b>Ferisol</b>	21E	Connor-Sager Assoc., Inc.	
Werbeagentur		Agence Domenach		<b>National Semiconductor Corp.</b>	35, 36
<b>Alco Electronics Products, Inc.</b>	134, 171, 173	<b>Filotex</b>	32E	Hall Butler Blatherwick, Inc.	
Marketronics Advertising		Rapy Publicite		<b>Niemand Industries</b>	170
<b>Allied Van Lines, Inc.</b>	119	<b>Florida Dept. of Commerce,</b>		Knudsen-Moore, Inc.	
Young & Rubicam, Inc.		<b>Div. of Commercial Development</b>	149	<b>Nippon Electric Co., Ltd.</b>	138
<b>Andrew Corp.</b>	60	William Cook Adv., Inc.		Hakuhodo, Inc.	
Fensholt Adv., Inc.		<b>Fluke Manufacturing Co., John</b>	17	<b>Non-Linear Systems, Inc.</b>	167
<b>Arco S.P.A.</b>	36E	Bonfield Associates		Ivy Associates, Inc.	
Studio Dondoro		<b>General Instrument Corp.,</b>		<b>North Atlantic Industries, Inc.</b>	26
<b>Ates Componenti Elettronici, S.P.A.</b>	40E	<b>Semiconductor Products Div.</b>	10, 11	Helme Associates	
Publicitas		Norman Allen Associates		<b>NV Delta Elektronika</b>	11E
<b>Barnes Corp.</b>	179	<b>General Instrument Europe S.P.A.</b>	16E	<b>Oak Mfg. Co., a Division of O/E/N</b>	180
Industrial Public Relations, Inc.		Studio Cigiemme		Buchen Adv., Inc.	
<b>Beckman Instruments, Inc.</b>	76	<b>General Instrument Microelectronics</b>	27E	<b>Olivetti &amp; C. Spa., Ing. C.</b>	35E
Helipot Div.		Michael Lawler & Borradaile, Ltd.		Studio Giuliano Blei	
N. W. Ayer/Jorgensen/MacDonald, Inc.		<b>General Magnetics</b>	8	<b>Optical Electronics</b>	139
<b>Bell Telephone Laboratories</b>	53	McCarthy/Scelba/DeBiasi Adv. Agcy., Inc.	2nd Cover	Craig Miller Advertising	
N. W. Ayer & Sons, Inc.		<b>General Radio Co.</b>			
<b>Bulova Watch Co., Electronics Div.</b>	22	Horton, Church and Goff, Inc.			
Caroe Marketing, Inc.		<b>Hewlett Packard, San Diego Div.</b>	1		
<b>Captor Corp.</b>	58	Lennen & Newell, Inc.			
Weber, Geiger & Kalat, Inc.		<b>Hewlett Packard, Santa Clara Div.</b>	2		
<b>Cerro Copper &amp; Brass Co.</b>	174	Lennen & Newell, Inc.		<b>Pechiney St Gobain</b>	38E
Sykes Adv., Inc.		<b>HI G D'Italia</b>	29E	PEMA	
<b>Chicago Miniature Lamp Works</b>	161	Studio Dullio Savina		<b>Philco Ford Co., Microelectronics Div.</b>	140
Buti-Roberts Advertising		<b>Honeywell Commercial Div.</b>	57	The Aitkin-Kynett Co., Inc.	
<b>Cimron Division of Lear Siegler, Inc.</b>	24	Campbell Mithun, Inc.		<b>Philips Electronics Instruments</b>	91
Phillips Ramsey, Inc.		<b>Honeywell Test Instruments Div.</b>	39	Marsteller, Inc.	
<b>Cinch Manufacturing Co.</b>	70	Campbell Mithun, Inc.		<b>Philips N. V. Pit/Tmi Division</b>	2E
Stral Adv. Co., Inc.		<b>I.E.R.</b>	20E	Marsteller International S.A.	
<b>Collins Radio Co.</b>	153	PEMA		<b>Pirgo Electronics, Inc.</b>	7
John G. Burnett Advertising		<b>Indiana General Corp.,</b>	40	Herbert Lindauer Associates	
<b>Colorado Video, Inc.</b>	168	<b>Electronics Div.</b>		<b>Portescap</b>	10E
Wolff & Weir		The Griswold & Eshleman Co.		Presse et Publicite	
<b>Cometa</b>	17E	<b>Indianapolis Power &amp; Light</b>	142		
Havas		Ruben, Montgomery & Assoc., Inc.		<b>RCA Electronic Components</b>	4th Cover, 163
<b>Computer Measurements Co.,</b>	151	<b>Integrated Circuit Engineering Corp.</b>	158	Al Paul Lefton Co.	
<b>Div. of Newell Industries</b>		N. A. Winter Advertising		<b>RCL Electronics, Inc.</b>	14
Jones, Maher, Roberts, Inc.		<b>Intel Corp.</b>	130	Morvay Advertising Agency	
<b>Computer Products, Inc.</b>	133	Bonfield Associates		<b>Redcor Corp.</b>	87
Grenman Associates, Inc.		<b>Iowa Development Commission</b>	169	Management Communication	
<b>Condor Foto</b>	36E	Creswell, Munsell, Schubert & Zirbet, Inc.	12E	Consultants, Inc.	
Black & Color		<b>Isostat</b>	42E	<b>Rogan Brothers</b>	168
<b>Cosmicar Optical Co., Ltd.</b>	34E	Editions Gead		Christopher Adv., Inc.	
Matsushita, Inc.		<b>ITT Components Group</b>	42E	Rohde & Schwarz	45E
<b>Counting Instruments</b>	22E	Brockie Haslam Chinery & Allon, Ltd.		<b>Roto-Therm Division Republic Corp.</b>	172
Walkley Hodgson, Ltd.		<b>Joslyn, Inc.</b>	154	Van Der Boom, McCarron, Inc., Adv.	
<b>Data Memory, Inc.</b>	49	Chace Co. Adv., Inc.		<b>Sage Electronics Corp.</b>	148
Hal Lawrence, Inc.		<b>Lambda Electronics</b>	3rd Cover, 183, 184	Mathison Adv., Inc.	
<b>Datum, Inc.</b>	162	Corp.		<b>Schlumber Ltd. EMD</b>	3E
Helme Assoc., Inc.		Michel Cather, Inc.		T. B. Brown, Ltd.	
<b>Delco Radio Division</b>	12, 13	<b>La Radiotechnique</b>	33E	<b>Schlumber SIS</b>	4E
General Motors Corp.		Agence Giorgi		T. B. Brown, Ltd.	
Campbell-Ewald Co.		<b>Litton Industries, Inc.,</b>	38	<b>Schlumber SOMU</b>	7E
<b>Delevan Electronics Corp.</b>	152	<b>Electron Tube Div.</b>		T. B. Brown, Ltd.	
Stahls, Fuller & Klenk, Inc.		MacManus, John & Adams, Inc.	24E, 25E	<b>Selenia</b>	41E, 43E
<b>Dialight Corp.</b>	123	<b>LTT</b>		Tilligraf	
Michel Cather, Inc.		Publibel		<b>Sescosem</b>	30E
<b>Digital Equipment Corp.</b>	75	<b>Lundy Electronics and Systems, Inc.</b>	176	Perez Publicite	
Kalb & Schneider, Inc.		Snow & Depew Adv., Inc.		<b>Sfernice</b>	6E
<b>Dow Corning Corp.</b>	30, 31	<b>McGraw-Hill Book Co.</b>	147	<b>SGS</b>	37E
Ketchum, MacLeod and Grove, Inc.		<b>Mallory and Co., P.R., Mfg. Div.</b>	55	Lonsdale Italia S.P.A.	
<b>Ducati Elettrotecnica Microfarad</b>	26E	Aitkin-Kynett Co.		<b>Sierra Research Corp.</b>	166
Studio Busoli Gastone		<b>Mallory Battery Co., Div. of</b>		B. P. Myer Assoc., Inc.	
<b>DuPont de Nemours &amp; Company,</b>	164	<b>P.R. Mallory and Co., Inc.</b>	32	<b>Signetics Corp., Sub.</b>	117
<b>Freon Div.</b>		Needham, Harper and Steers, Inc.		<b>Corning Glass Works</b>	
N. W. Ayer & Son, Inc.		<b>Markel and Sons, L. Frank</b>	159	Cunningham & Walsh, Inc.	
<b>Eastman Kodak Co.,</b>	155	George Moll Adv., Inc.		<b>Silec Electronique</b>	18E, 19E
<b>Business Systems Markets Div.</b>		<b>Masinexport</b>	163	Promotion Vente Publicite	
J. Walter Thompson Co.		Publicom Romanian International		<b>Simpson Electric Co.</b>	56
<b>Educational Computer Corp.</b>	37	Publicity Agency		Amerad Advertising Services, Inc.	
George Moll Adv., Inc.		<b>MIAL S.P.A.</b>	13E	<b>Socapex</b>	15E
<b>Elco Corp.</b>	23	Studio Bianchessi Davide		S.P.I.	
Schaefer Adv., Inc.		<b>Microwave Cavity Laboratories</b>	15	<b>Sogie</b>	8E
<b>El Instruments, Inc.</b>	179	Don Z Advertising		Etudes et Creations Publicitaire	
Froehlich Advertising Services		Midtex/Aemco	125	<b>Solartron Electronics Group Ltd.</b>	5E
<b>Electronic Computer Graphics</b>	176	Chuck Ruhr Assoc. Adv.		T. B. Brown Ltd.	
Durel Advertising		<b>Monroe Electronics, Inc.</b>	178	<b>Solitron Devices, Inc.</b>	118
<b>Electronic Memories</b>	156	Ruda Adv. Assoc.		Barnes-Champ/Advertising	
Durel Advertising		<b>Morganite Resistors, Ltd.</b>	46E	<b>Solitron Devices, Inc.</b>	97
<b>Electronics Network, The</b>	20, 21	Scientific Advertising & Marketing Ltd.		Christopher James Adv., Inc.	
Ries Cappiello Colwell, Inc.		<b>Motorola Semiconductor</b>	28, 29	<b>Solitron Devices, Inc., Transistor Div.</b>	25
<b>Elgenco, Inc.</b>	178	<b>Products, Inc.</b>		Haselmeire Pearson Adv., Inc.	
Drake Advertising		Lane & Wampler Adv., Inc.		<b>Souriau &amp; Cie.</b>	28E
<b>E/MC Electronics/Management Center</b>	176	<b>Multicore Solders, Ltd.</b>	14E	Ariane Publicite	
Ries Cappiello Colwell, Inc.		Jefferies Harper & Partners, Ltd.		<b>S. P. Electronica</b>	9E
<b>Erie Technological Products Co., Inc.</b>	127			Studio Sergio Rosata	
Walker, Schmidt & Mackall, Inc.				<b>Standard Memories, Inc.</b>	170
<b>Fairchild Semiconductor, Inc.</b>	67, 68, 69			M B Advertising Agency	
Chiat Day, Inc.					



# ELGENCO Noise Generators



Model 610A

## SOLID STATE NOISE GENERATORS

- Model 602A 5 Hz to 5 mHz, 3 Ranges \$ 360
- Model 603A 5 Hz to 5 mHz, 3 Ranges \$ 545
- Model 610A 5 Hz to 5 mHz, 8 Ranges \$1,275
- Model 632A Two outputs DC to 400 Hz and 10 Hz to 35 kHz . . . . . \$2,595
- Series 624 (Fixed frequency) 5 Hz to 500 kHz \$270 to \$600. Write for details on frequency ranges and spectral flatness.

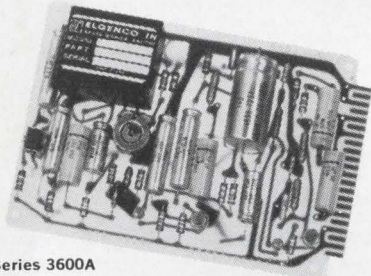

Series 3600A

## NOISE GENERATOR CARDS

- Series 3600 . . . . . \$144 to \$409
- Various frequency ranges and output flatness available. Write for details.

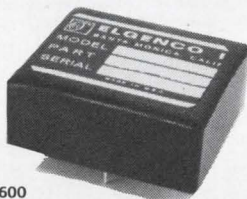

Series 1600

## ENCAPSULATED NOISE SOURCE MODULES

- Series 1600 . . . . . \$95 to \$350
- Various frequency ranges and output flatness available. Write for details.

## VACUUM TUBE NOISE GENERATORS

- Model 301A DC to 40 Hz . . . . . \$2,195
- Model 311A Two outputs DC to 40 Hz and 10 Hz to 20 kHz . . . . . \$2,595
- Model 312A Two outputs DC to 120 Hz and 10 Hz to 20 kHz . . . . . \$2,695
- Model 321A DC to 120 Hz . . . . . \$2,295
- Model 331A 10 Hz to 20 kHz . . . . . \$1,395

For a more complete listing of Elgenco noise generators, write for short form catalog.

## ELGENCO INCORPORATED



1550 Euclid Street  
Santa Monica, California  
Phone: (213) 451-1635  
TWX: (213) 879-0091  
Cable: Elgenco

DEMONSTRATOR MODEL'S AVAILABLE  
See EEM or Write for Name of Nearest Rep.

- Sylvania Electric Products, Inc., Parts Div. 73
- Doyle Dane Bernbach, Inc. 136
- TEC, Inc. 136
- Stevenson and Assoc., Inc. 120
- Tektronix, Inc. 120
- Dawson, Inc. 120
- Texas Instruments Incorporated, Components Group 18, 19
- Albert Frank-Guenter Law, Inc. 16
- Texscan Corp. 16
- MacGill/Ross, Inc. 51
- Thomson Electric Co., Inc. 51
- Mohr & Co., Inc. 59
- Triplett Electrical Instrument Co. 41
- Byer and Bowman Advertising TRW Semiconductors, Inc. 41
- Fuller & Smith & Ross, Inc. 128
- Tung-Sol Division Wagner Electric Corp. 128

- United Aircraft Electronic Components 74
- Cunningham & Walsh, Inc. Advertising 47
- Unitrode Corporation 47
- Siltron Brothers, Inc. 178
- Universal Relay Corp. Chelsea Adv., Inc. 178

- Wang Laboratories 135
- Impact Advertising, Inc. 146
- Watkins-Johnson Co. (CEI) 143
- William C. Estler Advertising 143
- Winchester Electronics, Div. of Litton Industries 42
- Wilson, Haight & Welch, Inc. 172

- Xerox Data Systems 42
- Doyle, Dane, Bernbach, Inc. 172

- Zippertubing Co. 172
- Edward S. Kellogg Co. 172

## Classified & Employment Advertising

F.J. Eberle, Manager  
212-971-2557

## EMPLOYMENT OPPORTUNITIES

Joseph P. Corcoran, Personnel Consultants 175

## EQUIPMENT

(Used or Surplus New)  
For Sale  
Hunting Oilfield Services, Ltd. . . . . 175  
Radio Research Instrument Co. . . . . 175

- For more information on complete product line see advertisement in the latest Electronics Buyer's Guide
- Advertisers in Electronics International

## Electronics Buyers' Guide

George F. Werner, Associate Publisher  
[212] 971-2310

Robert M. Denmead, Midwest Regional Manager  
[312] MO 4-5800

Cliff Montgomery, New York District Manager  
[212] 971-3793

Regina Hera, Directory Manager  
[212] 971-2544

Mary Tully, Production Manager

Circulation Department  
Isaaca Siegel, Manager [212] 971-6057

Research Department  
David Strassler, Manager [212] 971-6058

# LARGEST AND MOST DIVERSIFIED STOCK OF RELAYS IN THE WORLD!

We also stock MICROSWITCHES®

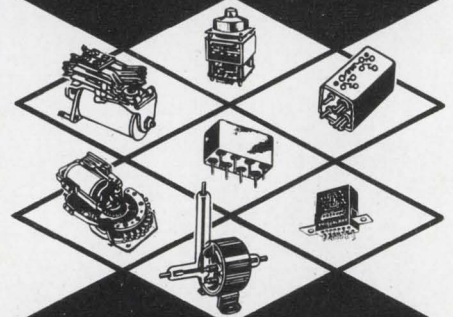

Faster Delivery / Lower Prices  
All Types / Most Makes

SEND FOR  
CATALOG E

# Universal RELAY CORP.

42 White St., New York, N.Y. 10013  
(212) 925-6900 • TWX 710-581-4461

Circle 194 on reader service card

# 111 MEGOHMS IN 0.1 MEGOHM STEPS

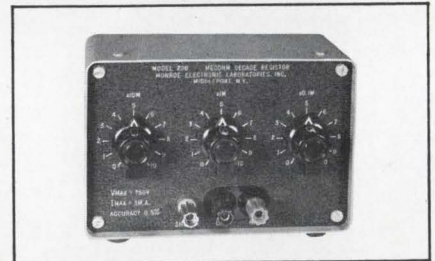

MODEL 206 MEGOHM  
DECADE RESISTORS  
Price: \$125

Where megohm resistor values are required, the Model 206 provides high accuracy and stability with low negative temperature coefficients.

- low leakage switches and connectors
- accuracy  $\pm 0.5\%$
- 750 volts, 3 ma. max.
- fully shielded

SEND FOR DATA SHEET



MONROE ELECTRONICS, INC.  
5 VERNON STREET MIDDLEPORT, NEW YORK

Area Code 716, 735-3721

Circle 192 on reader service card



## Advertising Sales Staff

**Dan McMillan III** [212] 971-3468  
Associate Publisher

**Wallis Clarke** [212] 971-2187  
Advertising Sales Service Manager

**Tomlinson Howland** [212] 971-6792  
Promotion Manager

**Warren H. Gardner** [212] 971-3139  
Eastern Advertising Sales Manager

Atlanta: Ga. 30309: Charlton H. Calhoun, III  
1375 Peachtree St., N.E.  
[404] 892-2868

Boston, Mass. 02116: William S. Hodgkinson  
McGraw-Hill Building, Copley Square  
[617] CO 2-1160

Cleveland, Ohio 44113: William J. Boyle, 55  
Public Square, [216] SU 1-7000

New York, N.Y. 10036  
500 Fifth Avenue

James R. Pierce [212] 971-3615

John A. Garland [212] 971-3617

Michael J. Stoller [212] 971-3616

Philadelphia, Pa. 19103:

Jeffrey M. Preston  
6 Penn Center Plaza,  
[215] LO 8-6161

Pittsburgh, Pa. 15222: Jeffrey M. Preston,

4 Gateway Center, [412] 391-1314

Rochester, N.Y. 14534: William J. Boyle,

9 Greylock Ridge, Pittsford, N.Y.  
[716] 586-5040

Chicago, Ill. 60611: Ralph Hanning,

Kenneth E. Nicklas, 645 North Michigan  
Avenue, [312] MO 4-5800

Dallas, Texas 75201: Richard P. Poole, 1800

Republic National Bank Tower,  
[214] RI 7-9721

Houston, Texas 7702: Richard P. Poole

2270 Humble Bldg. [713] CA 4-8381

Detroit, Michigan 48226: Ralph Hanning,

856 Penobscot Building  
[313] 962-1793

Minneapolis, Minn. 55402: Kenneth E. Nicklas,

1104 Northstar Center [612] 332-7425

St. Louis, Mo. 63105: Kenneth E. Nicklas,

The Clayton Tower, 7751 Carondelet Ave.  
[314] PA 5-7285

James T. Hauptli [415] DO 2-4600

Western Advertising Sales Manager

Denver, Colo. 80202: David M. Watson,

Richard W. Carpenter  
Tower Bldg., 1700 Broadway  
[303] 266-3863

Los Angeles, Calif. 90017: Ian C. Hill,

Bradley K. Jones, 1125 W. 6th St.,  
[213] HU 2-5450

Portland, Ore. 97204: Don Farris,

James T. Hauptli, 218 Mohawk Building,  
222 S.W. Morrison Street,  
Phone [503] 223-5118

San Francisco, Calif. 94111: Don Farris,

James T. Hauptli, 255 California Street,  
[415] DO 2-4600

Pierre Braude Tel: 727 73 01: Paris

International Director

Paris: Denis Jacob

17 Rue-Georges Bizet, 75 Paris 16, France  
Tel 727 33 42, 727 33 60

United Kingdom and Scandinavia

London: Oliver Ball, Tel: Hyde Park 1451

34 Dover Street, London W1

Milan: Robert Saldel, Roberto Laurer Jr.

1 via Baracchini Phone 86-90-656

Brussels: Denis Jacob

27 Rue Ducale Tel: 136503

Frankfurt/Main: Hans Haller

Elsa-Brandstroem Str. 2  
Phone 72 01 81

Geneva: Pierre Braude

1 rue du Temple Phone: 31 95 60

Tokyo: Noboru Matsumoto, McGraw-Hill

Publications Overseas Corporation,  
Kasumigaseki Building 2-5, 3-chome,  
Kasumigaseki, Chiyoda-Ku, Tokyo, Japan  
[581] 9811

Osaka: Akihiko Kamesaka, McGraw-Hill

Publications Overseas Corporation, Kondo  
Bldg., 163, Umegae-cho Kita-ku [362] 8771

Australasia: Warren E. Ball, IPO Box 5106,

Tokyo, Japan

Business Department

Stephen R. Weiss, Manager

[212] 971-2044

Thomas M. Egan,

Production Manager [212] 971-3140

Maury D'Gongora,

Assistant Production Manager [212] 971-2045

Dorothy Carmesin, Contracts and Billings

[212] 971-2908

Frances Vallone, Reader Service Manager

[212] 971-2865

Business Department

Stephen R. Weiss, Manager

[212] 971-2044

Thomas M. Egan,

Production Manager [212] 971-3140

Maury D'Gongora,

Assistant Production Manager [212] 971-2045

Dorothy Carmesin, Contracts and Billings

[212] 971-2908

Frances Vallone, Reader Service Manager

[212] 971-2865

# SUPER SOCKETS!

**NEW BARNES  
HIGH-RELIABILITY PRODUCTION  
MOUNTING DIP SOCKETS  
... NONE BETTER**

Maximum reliability, longest life, highest quality, low cost too—all in one socket! New Barnes 121-2002 Series Production Mounting DIP Sockets. 10,000-plus insertion capability also increases usefulness for aging and burn-in applications. Interchangeable phosphor/bronze double wiping action type contacts/terminals replace easily—even while sockets are wired on P.C. boards! Accepts standard 14-lead DIP devices, features chamfered lead entrances and removable lids in black & white for easy color coding. Get the SUPER SOCKETS from Barnes. Send for more data.

**barnes** CORPORATION  
Lansdowne, Pa. 19050 • 215/MA 2-1525

**barnes** / THE WORLD'S MOST COMPLETE LINE OF SOCKETS, CARRIERS AND CONTACTORS FOR I.C.'S

Circle 193 on reader service card

## DYNAMIC CIRCUIT BREADBOARD

Take the mess out of breadboarding with the ELite 1

This unique instrument takes all of the scavenging and soldering out of design, yet will accommodate any combination of IC's and Discrete Components

**BUILT-IN FEATURES ARE:**

- Precision pulse generator
- Variable frequency, ampl. and width
- Variable lower supply
- Neon lamp display with drivers
- No special tools, plugs or patch cords are required
- Size is only 4 1/2" high, 15" wide, 11" deep

**WITH THESE ADVANTAGES:**

- Total breadboarding without soldering
- Complete bread inter-connection with solid #22 wire
- Convenient desk-top operation

Use the ELite 1 for all designing, testing and burn-in thereby reducing your breadboarding to inserting components, inter-connected with #22 wire and monitoring circuit responses via the built-in neon display

Write or phone for complete specifications and catalog

**ELI** EL Instruments Incorporated  
61 First Street, Derby, Conn. 06418 • Phone 203/735-8774





**OAK ECONO-LINE  
PUSHBUTTON<sup>T.M.</sup>  
JUST 25¢ A BUTTON\***

\*For most applications

We've got the button... throws from 1 PST to 8 PDT per button; sizes: .388" sq., .388" x .585" or .388" x .782"; legends engraved to your specifications; black or white buttons are standard, other colors on special order.

Push Rod Stroke...  $\frac{3}{32}$ " plus  $\frac{3}{4}$ " overtravel; push rod lengths optional at  $\frac{1}{2}$ ",  $\frac{5}{8}$ " standard length,  $\frac{3}{4}$ ",  $\frac{7}{8}$ " and 1".

Easy to wire... clips are Oak-pioneered double-wiping. For printed circuit boards or wire-soldering, PCB terminals are  $\frac{3}{32}$ ",  $\frac{1}{8}$ ",  $\frac{3}{16}$ " standard length,  $\frac{7}{32}$ " and  $\frac{1}{4}$ " shoulder to tip. Choose terminals for wiring only or P.C. dual-purpose which have the wire hole in addition to the P.C. lug.

Compact Convenience... more buttons per area—24 on .394" centers, 16 on .591" centers, 12 on .788" centers. Any switching—momentary, push-push, interlock, or blockout or combinations. For full details, write today for Bulletin SP-346.

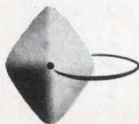

**OAK MANUFACTURING CO.**  
A Division of OAK ELECTRO/NETICS CORP.  
Crystal Lake, Illinois 60014  
Phone: 815-459-5000 TWX: 910-634-3353

**Equipments and Systems**

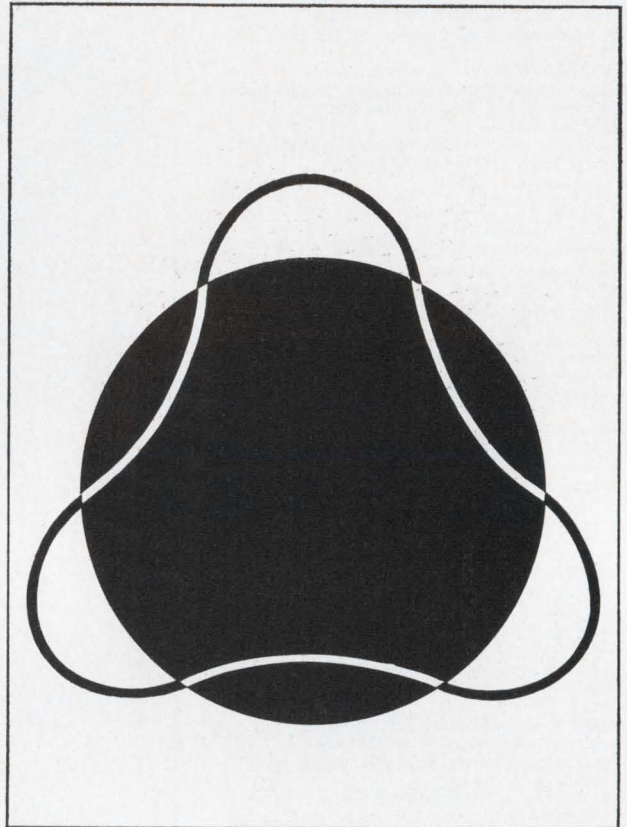

922.833

**bearing the  
TELEFUNKEN trademark  
are symbols of  
progress in the World**

We manufacture and supply: Broadcasting and television transmitters · Communications transmitters · Maritime transmitters and transceivers · Professional receivers and direction finders · Radars · Radiotelephone sets and systems · Telecommunications equipment and cables · Data processing systems

Write for comprehensive documentation

ALLGEMEINE ELEKTRICITÄTS-GESELLSCHAFT  
AEG-TELEFUNKEN  
Export Department  
79 Ulm · Elisabethenstraße 3  
Germany



**AEG-TELEFUNKEN**



# New IC regulated bench power supply with built-in, tracking overvoltage protection

**0-10 volts, 1 amp, \$90 with OV**  
**0-10 volts, 1 amp, \$75 less OV**

Also available 0-20, 0-40, 0-120 vdc

### Regulation

line 0.01% + 1mv  
 load 4 mv

### Ripple and noise

250  $\mu$ v rms; 1 mv p-to-p

### All silicon DC power supply using integrated circuits to provide regulation system

except for input and output capacitors, rectifiers and series regulation transistors

### Multi-position operation

lies flat or stands erect

### AC input

105-132 vac 47-440 Hz (Current ratings based on 57-63 Hz.)

### Weight

less than 5 lbs.

### Output

5-way binding posts

### Ambient operating temperature

0-50°C

### Temperature coefficient

0.015% + 300  $\mu$ v/°C

### Adjustable current limiting

0% to 110% of rating

### Storage temperature

-40°C to +85°C

### Convection cooled

### Die-cast aluminum construction

### No overshoot

on turn-on, turn-off or power failure

### Controls

coarse voltage adjust, fine voltage adjust, current adjust, ON/OFF switch, meter function switch.

### Indicators

power ON light and dual-function meter

### Guaranteed for 5 years material and labor

### LL series bench-type supply 5 5/8" x 5 1/2" x 3 3/8"

Model	ADJ. VOLT RANGE VDC	CURRENT RANGE <sup>(1)</sup>	Price <sup>(2)</sup>
LL-901	0-10	0-1.0 amp	\$75
LL-902	0-20	0-0.65 amp	85
LL-903	0-40	0-0.35 amp	85
LL-905	0-120	0-65 ma	99

### WITH BUILT-IN TRACKING OVERVOLTAGE PROTECTION

LL-901-OV	0-10	0-1.0 amp	\$90
LL-902-OV	0-20	0-0.65 amp	99
LL-903-OV	0-40	0-0.35 amp	99

### NOTES:

(1) Consult factory for operation at 50 Hz or temperatures above 50°C. Ratings apply 0-50°C.

(2) Independently adjustable OV protection available as accessory on LL-901, 902 (LC-OV-10, range 3-24 vdc) and LL-903 (LC-OV-11, range 3-47 vdc) price \$20.

(3) All prices F.O.B. Melville, N. Y. All prices and specifications subject to change without notice.

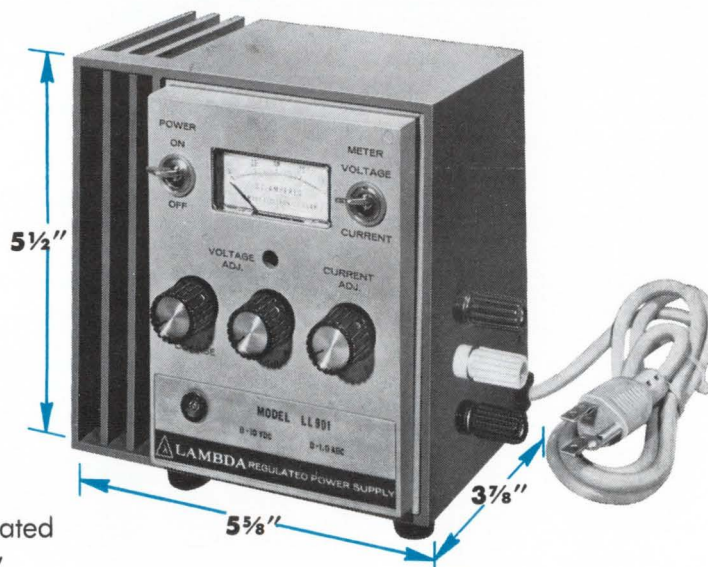

LL series I-C regulated power supply

Lambda Electronics Corp., 515 Broad Hollow Road, Melville, L. I., New York 11746 • Tel. 516-694-4200.



# Lambda's LPD series offer more amps per \$ than any other general-purpose dual lab supply.

also available with single output... LP series

## Features of LPD series dual output power supply

### 5 models with two independent DC outputs

up to  $\pm 250$  vdc, up to 1.7 amps. Either output may be + or -, or both outputs may be + or -.

### Series/parallel operation

of both outputs yields two times the voltage or two times the current—up to 500 volts or up to 3.4 amps.

### Auto series/auto parallel (master-slave)

permits tracking to a common reference.

### 4 meters

provide simultaneous monitoring of both voltage and current.

### Regulation

line or load .01% + 1 mv.

### Ripple

500  $\mu$ v rms (1.5 mv p-p)

### A-C input

105-132 vac 47-440 Hz (ratings based on 57-63 Hz operation). For operation at 205-265 vac, add suffix "-V" to model numbers and 10% or \$25.00 (whichever is greater) to price.

### Multi-current-rated

## Additional features of LP and LPD series

All silicon semiconductors

Bench or rack use

Remotely programmable

Remote sensing

Continuously variable

Designed to meet RFI per MIL-STD-826A

### Fungus-proofing option

add suffix "R" to model number and add \$15.00 to price.

### Overvoltage protection

available as an option up to 70 vdc

## LPD dual output models

5 $\frac{3}{16}$ " x 8 $\frac{3}{8}$ " x 10 $\frac{3}{32}$ "

Model	Voltage Range Per output/ Outputs in series	MAX AMPS AT AMBIENT OF: (1) Per output. Outputs in parallel				Price
		VDC	30°C	40°C	50°C	
*LPD-421-FM	0- $\pm 20$ /0-40	1.7A/3.4A	1.5A/3.0A	1.3A/2.6A	0.9A/1.8A	\$290
*LPD-422-FM	0- $\pm 40$ /0-80	1.0A/2.0A	0.85A/1.7A	0.7A/1.4A	0.55A/1.1A	290
*LPD-423-FM	0- $\pm 60$ /0-120	0.7A/1.4A	0.6A/1.2A	0.5A/1.0A	0.4A/0.8A	325
LPD-424-FM	0- $\pm 120$ /0-240	0.38A/0.76A	0.32A/0.64A	0.26A/0.52A	0.20A/0.40A	325
LPD-425-FM	0- $\pm 250$ /0-500	0.13A/0.26A	0.12A/0.24A	0.11A/0.22A	0.10A/0.20A	350

### LPD NOTES:

\*OVERVOLTAGE PROTECTION AVAILABLE AS AN ACCESSORY. EACH OUTPUT REQUIRES SEPARATE OV ACCESSORY—ADD \$35.00 FOR EACH OUTPUT.

(1) CURRENT RATING APPLIES OVER ENTIRE VOLTAGE RANGE. RATINGS BASED ON 57-63 HZ OPERATION.

## LP single output models

5 $\frac{3}{16}$ " x 4 $\frac{3}{16}$ " x 10"

Model	VOLTAGE RANGE	CURRENT RANGE AT AMBIENT OF 1:				Price
		30°C	40°C	50°C	60°C	
LP-410-FM	0-10 VDC*	0-2A	0-1.8A	0-1.6A	0-1.4A	\$140
LP-411-FM	0-20 VDC*	0-1.2A	0-1.1A	0-1.0A	0-0.8A	140
LP-412-FM	0-40 VDC*	0-0.70A	0-0.65A	0-0.60A	0-0.50A	140
LP-413-FM	0-60 VDC*	0-0.45A	0-0.41A	0-0.37A	0-0.33A	140
LP-414-FM	0-120 VDC	0-0.20A	0-0.18A	0-0.16A	0-0.12A	160
LP-415-FM	0-250 VDC	0-80mA	0-72mA	0-65mA	0-60mA	175

### LP NOTES:

\*OVERVOLTAGE PROTECTION AVAILABLE AS AN ACCESSORY—\$35.00 EACH.

(1) CURRENT RATING APPLIES OVER ENTIRE VOLTAGE RANGE.

## Overvoltage protectors (accessories)

For use with	Model	ADJ. VOLT RANGE	Price*
LP-410; (0-10VDC)	LH-OV-4	3-24V	\$35
LP-411; LPD-421-FM (0-20VDC)	LH-OV-4	3-24V	35
LP-412; LPD-422-FM (0-40VDC)	LH-OV-5	3-47V	35
LP-413; LPD-423-FM (0-60VDC)	LH-OV-6	3-70V	35

\*PRICE IS FOR A SINGLE OVERVOLTAGE ACCESSORY. LPD SERIES MODELS REQUIRE ONE LH-OV FOR EACH OUTPUT.



LP Series

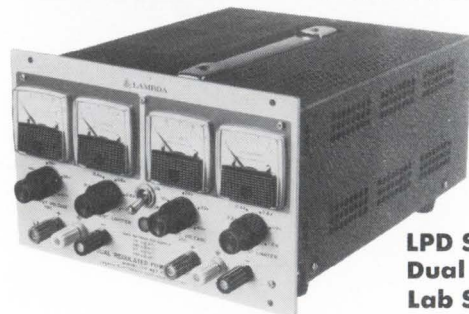

LPD Series  
Dual Output  
Lab Supply



Lambda Electronics Corp. 515 Broad Hollow Road, Melville, L. I., New York 11746. Tel. 516-694-4200.



# To get a high-current power supply with **80% efficiency** ...get Lambda's LB Series.

**Convection-cooled      7-inch panel**  
**Only 10 mv ripple, up to 300 volts; up to 300 amps.**

**Up to 80% efficiency**

**Low ripple**  
 10 mv rms max.

**Regulation**  
 line .05% + 6 mv.  
 load 0.1% + 10 mv.

**AC input**  
 208 ± 10% vac: 57-63 Hz, 3 phase 4 wire.

**All silicon semiconductors**  
 for maximum reliability

**Convection cooled**  
 no blowers, no external heat sinks

**Overvoltage protection**  
 standard on all models up to 70 vdc

**Remotely programmable**

**Remote sensing**

**Transformer**  
 designed to MIL-T-27C Grade 6

**Completely protected**  
 Short circuit proof. Continuously adjustable automatic current limiting.

**Constant voltage/constant current**  
 by automatic crossover

**Temperature coefficient**  
 0.03% + 0.5 mv/°C

**Series/parallel operation**

**Multi-current-rated**

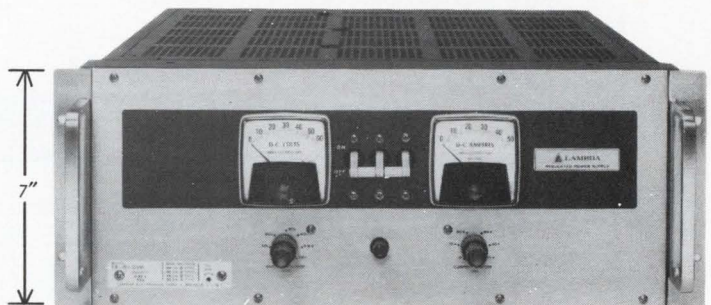

**LB Series, metered, full-rack**

**Size: 7" x 19" x 20 1/16"**

Model	VOLTAGE RANGE	MAX. CURRENT (AMPS) AT AMBIENT OF: <sup>(1)</sup>				Price <sup>(2)</sup>
		40°C	50°C	60°C	71°C	
LB-701-FM-OV	0-7.5	300	270	235	200	\$1,450
LB-702-FM-OV	0-15	180	170	160	150	1,450
LB-703-FM-OV	0-36	80	75	70	65	1,200
LB-704-FM-OV	0-60	50	47	44	40	1,300
LB-705-FM	0-125	25	22	19	16	1,100
LB-706-FM	0-300	10	9.5	9.0	8.0	1,250

**NOTES:**

(1) Current rating applies over entire voltage range.

(2) Prices include meters. LB Series models are not available without meters. Prices for all models up to and including 60 vdc include built-in overvoltage protection. Prices and specifications are subject to change without notice.

(3) Chassis Slides: Add suffix (-CS) to model number and add \$100.00 to price.

**Lambda has over 10,000 power supply units on-the-shelf for 1-day delivery.**

**Every one fully guaranteed for 5 years... material and labor.**

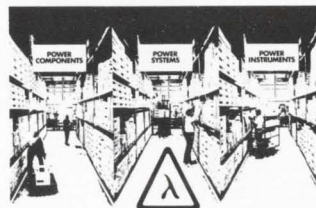

**LAMBDA**  
**ELECTRONICS CORP.**

A Veeco Company



# New IC Switch from the Triac Leader

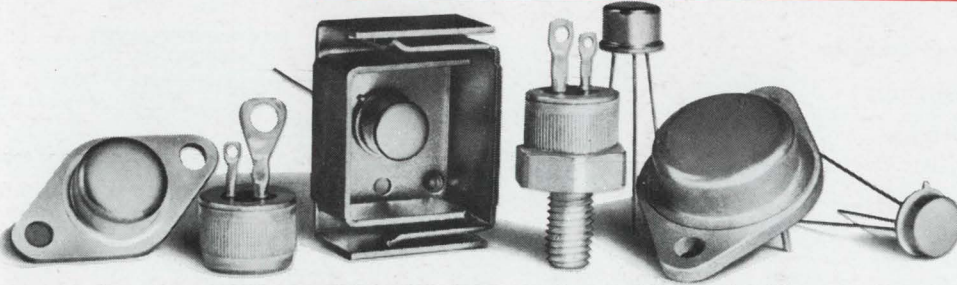
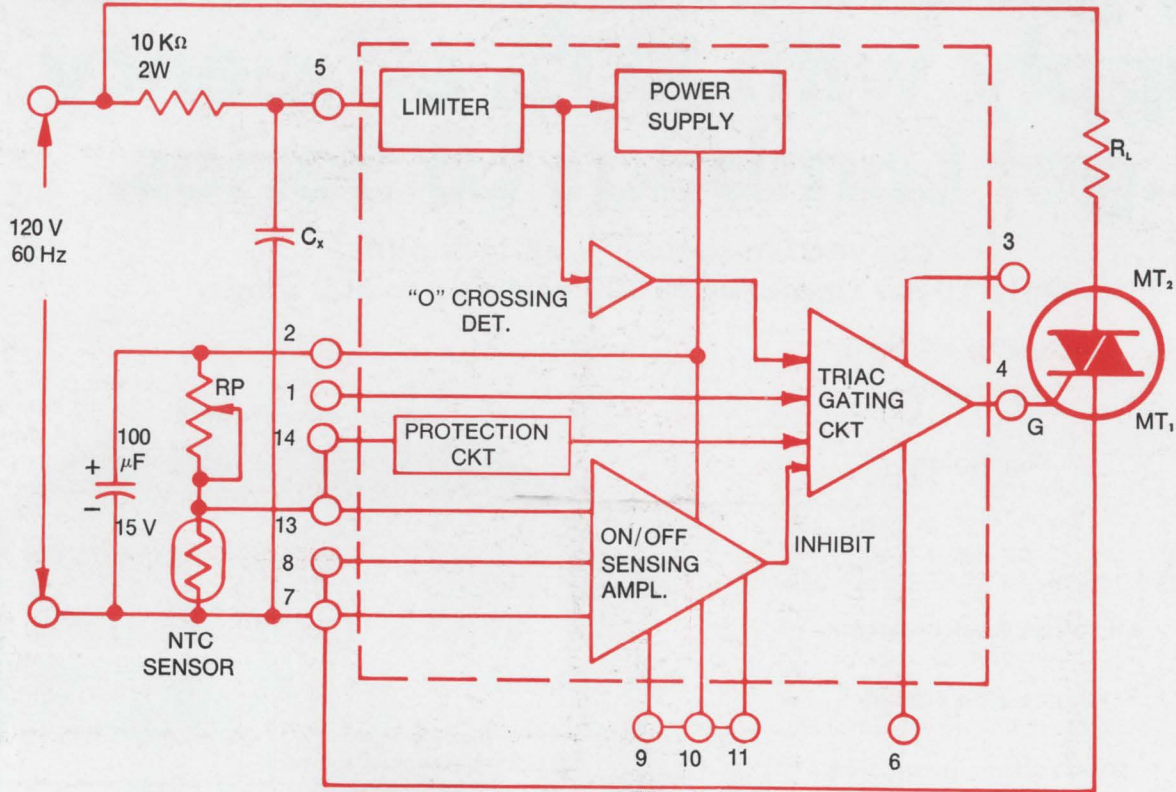

## RCA-CA3059 Zero-Voltage Switch for New Economy, New Simplicity in Thyristor Trigger Circuits \$1.95 (1000-unit level)

Here's RCA's economical, new approach to Thyristor triggering—the CA3059 monolithic zero-voltage switch, at \$1.95 (1000 units). For efficient triggering of Triacs and SCR's with current ratings to 40 amperes—in applications such as electric heating, motor on/off controls, one-shot controls, and light-flashing systems—CA3059 offers these important new design advantages:

- Triggers Thyristors at zero-voltage crossing for minimum RFI in applications at 50, 60, 400 Hz.
- Self-contained DC power supply with provision for supply of DC bias current to external components.
- Built-in protection against sensor failure.
- Flexible connection arrangement for adding hysteresis control or proportional control.
- External provisions for zero-current switching with inductive loads.

- On/off accuracy typically 1% with 5 kΩ sensor; 3% with 100 kΩ sensor.

- Triacs in RCA's 2.5–40 Amp, 100–600 Volt series, Types 40693–40734, are selected to operate over the entire CA3059 temperature range.

- 14-lead DIP pkg. for  $-40^{\circ}\text{C}$  to  $+85^{\circ}\text{C}$  operation. For further details, check your local RCA Representative or your RCA Distributor. For technical data bulletin, file no. 397, and Application Note ICAN4158, write RCA Electronic Components, Commercial Engineering, Section ICN3-2 Harrison, N.J. 07029. In Europe, contact: RCA International Marketing S.A. 2-4 rue du Lièvre, 1227 Geneva, Switzerland.

**RCA** Integrated  
Circuits