

Product planning, a science or an art? 86
Surveying CAD programs and models 98
'Grand Tour'—stretching the technology 108

\$1.00 A McGraw-Hill Publication

March 30, 1970

Electronics®

**LSI: the package
is the problem**





THE "INTERMEDIATE" SYNTHESIZER

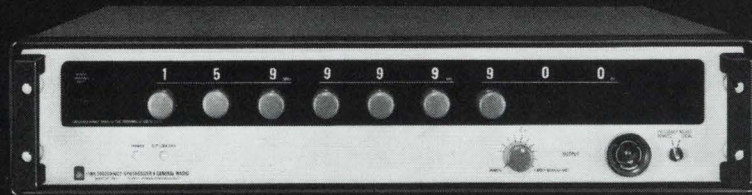

160 MHz for \$5900

Buying a frequency synthesizer has been something like buying a car. There's a confusion of models, options, and price ranges. Except — there has never been a so-called "intermediate"-model synthesizer. That's because price and performance ranges of synthesizers have tended to cluster just at both ends of the spectrum. The choice was between lower-cost, limited-frequency-range models and those with everything, including a sky-high price tag. So, the buying decision was one based on either trade-off or over-capability.

This is not true any longer! GR has filled the price-capability gap with the new 1165 Frequency Synthesizer. Frequency range is wide, 0.01 to 160 MHz in 100-Hz steps. The price is only \$5900, less than half the price it used to cost to get 160 MHz. If you can furnish your own frequency reference signal (5 or 10 MHz), you can get a model for only \$5300. In the \$5900 model, frequency accuracy is maintained either by an internal precision 10-MHz oscillator (1×10^{-9} per day) or by an external drive or lock source. Output is 0.1 to 1 V into 50 ohms. Both frequency and level can be externally programmed; the 1165 is ideal for applications requiring remotely-programmed local oscillators. Harmonics are typically down 30 dB (at maximum output into 50- Ω load); spurious, discrete non-harmonic signals are typically down 60 dB.

For complete information, write General Radio, West Concord, Mass. 01781; telephone (617) 369-4400. In Europe: Postfach 124, CH 8034, Zurich, Switzerland.

GENERAL RADIO



New HP 250 MHz Scope Takes the Pressure Off Calibration Labs

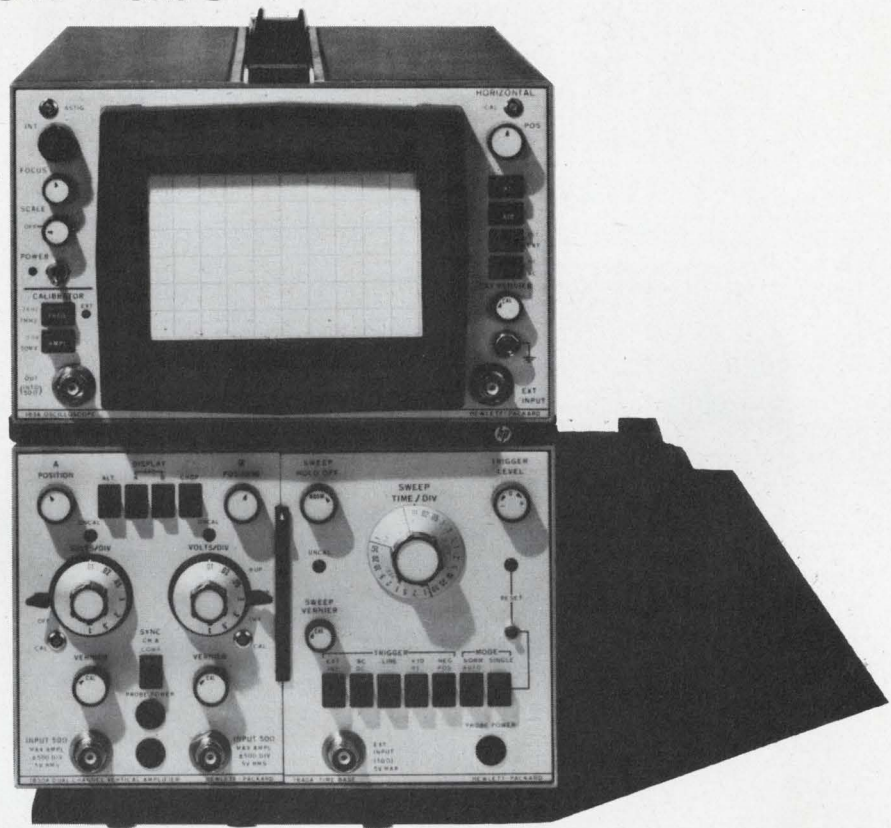

Components required to calibrate
the HP 1830A vertical amplifier.



Components required to calibrate
the HP 1840A horizontal time base.

The new 250 MHz real-time 183A scope has fewer calibration adjustments than any other high frequency scope on the market. That means you can cut the time required for scope calibration to a bare-bones minimum—and reduce your downtime at the same time!

Design of the 183A is new throughout—state-of-the-art technology, including integrated circuits, is used so fewer adjustments are necessary to provide calibration. For example, in the HP 1830A Dual Channel Vertical Amplifier, you have one high frequency R-C adjustment, pulse response—the *only* high frequency adjustment in this plug-in. And the 1840A Time Base has only one HF capacitive adjustment, stability! (Other calibration adjustments: 1830A—five variable resistors to set offset and

sync balance. 1840A—five variable resistors, one variable capacitor to set sweep timing, balance, and trigger sensitivity.)

But that's not all! The calibrator built into the 183A mainframe gives you <1 ns rise time at 2 kHz or 1 MHz, with 50 mV or 500 mV amplitude. You can quickly spot check time, amplitude and pulse response calibration on the line or on the bench.

From the performance standpoint, the 183A mainframe works with any of the 180 series plug-ins, at full published specs—four channel, differential/dc offset, 12.4 GHz sampling, 35 ps time domain reflectometer, to mention only a few.

Count and compare the number of adjustments and you'll know why the 183A can take the pressure off your metrology or calibration lab.

With today's increasing demand for the newer, higher frequency scopes, you're going to have to stock a whole new series of parts—so, go with the low cal, high performance champ—the HP 183A Oscilloscope.

Get full details on the new 183A and the entire 180 Scope System from your nearest HP field engineer. Or, write to Hewlett-Packard, Palo Alto, California 94304. Europe: 1217 Meyrin-Geneva, Switzerland. Price: HP 183A 250 MHz mainframe, \$1750; HP 1830A 250 MHz Dual Channel Vertical Amplifier, \$850; HP 1840A 250 MHz Time Base, \$550.

080/1A

HEWLETT  PACKARD
OSCILLOSCOPE SYSTEMS

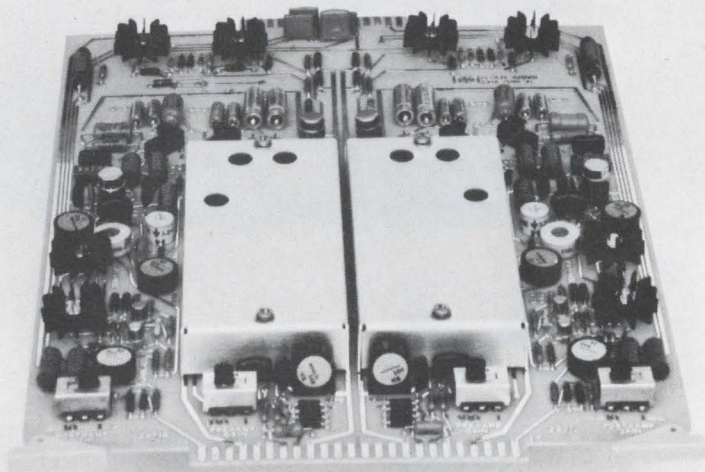
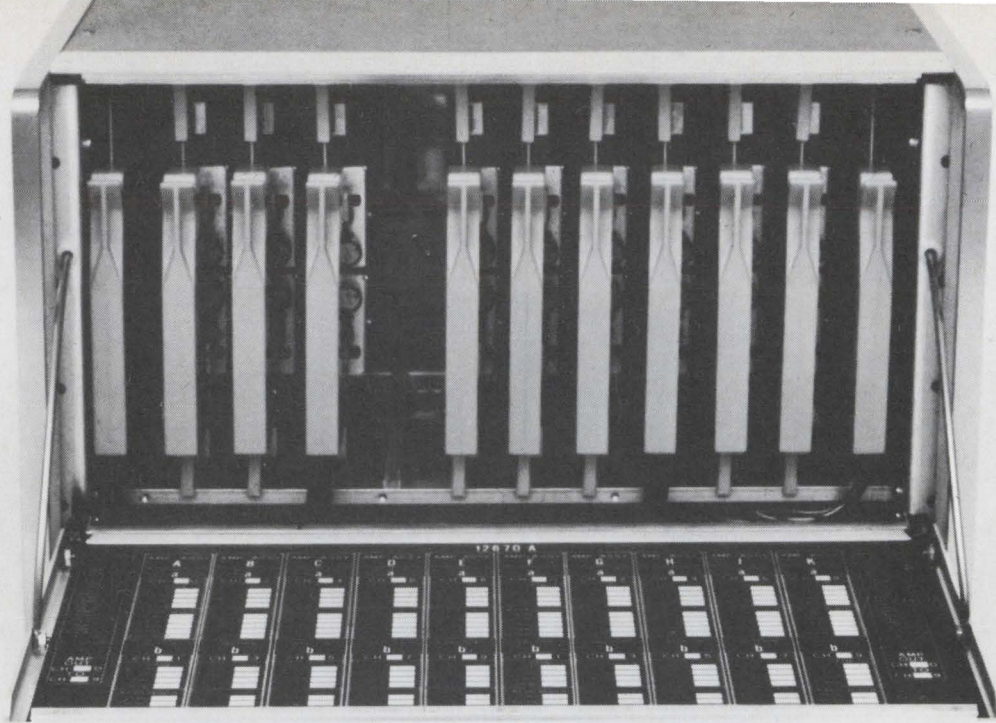

The data amp with the expected difference.

Hewlett-Packard's new 2471A is designed for high-speed amplifier-per-channel systems. And it's got exactly the kind of features you're looking for: low drift, high CMR, four calibrated gains, and five selectable bandwidths. As you'd expect in any high quality data amp.

But there's more: 100% computer testing of critical circuits from 0° to 55°C, matching of IC amps to within $1/2 \mu\text{V}/^\circ\text{C}$, and completely reliable operation in 95% humidity at up to

40°C. Only as you'd expect from HP.

The amplifiers are mounted in pairs on circuit boards for easy, plug-in installation. And frequently-set controls, such as gain-select switches and input zero pots, are located up front to permit system set-up without removal of the boards.

With two independent channels per plug-in, HP's new systems data amplifier offers you up to 20 channels of high quality amplification, complete with combining case, power supply and connectors, all for a cost of less than

\$370 per channel.

For all the specifications on the data amp with the difference you expect only from HP, call your local field sales engineer. Or write Hewlett-Packard, Palo Alto, California 94304; Europe: 1217 Meyrin-Geneva, Switzerland.

06002

HEWLETT  PACKARD

DATA ACQUISITION SYSTEMS
Circle 2 on reader service card

Features

Probing the News

- 123 **Packaging I:** Package shortages, unreliability and late deliveries plague LSI makers
- 126 **Packaging II:** LSI houses gear up to fill their own packaging needs

U.S. Reports

- 45 **Advanced technology:** Bell's storage and logic device
- 46 **Displays:** New flat-screen approach
- 47 **Companies:** Plated-wire memories off the shelf
- 48 **Government:** R&D spending levels off
- 50 **Commercial electronics:** Point-of sale credit check
- 52 **Industrial electronics:** Quick fingerprint identification
- 52 **Computers:** CDC's new super STAR
- 54 **Instrumentation:** Cutting calibration time

Electronics International

- 69 **International:** Standards—barrier to trade?
- 69 **East Germany:** A new link to Moscow—for data
- 70 **Great Britain:** Taken to task
- 71 **France:** Trial balloons; a breadboard for IC's

New Products

- 133 **In the spotlight**
- 133 MOS array is custom-programmable
- 134 Monolithic numerics go to market
- 137 **Instruments review**
- 137 Counter is simple, inexpensive
- 138 Teletypewriter controls instruments
- 141 **Production equipment review**
- 141 Bonder indexes automatically
- 145 **Data handling review**
- 145 Data points linked by wire or i-r
- 149 **Semiconductor review**
- 149 Regulators furnish up to 400 ma

Articles

- Special report** 86 **There's more to product planning than the generation of new ideas**
Planners must blend skills of engineering and marketing to keep pace with competition; the trend appears to be toward teamwork
- Circuit design** 94 **Designer's casebook**
- Negative impedance stabilizes motor's speed
 - Signal detector operates from 5-volt supply
 - Inverted-mode transistors give chopper low offset
- Design theory** 98 **Thinking of getting into CAD? You don't have to go far to find a program**
There are many programs from which to choose
G.W. Zobrist,
University of South Florida
- Space electronics** 108 **TOPS' trails to outer planets map a new route to reliability**
The crucial elements in lengthy outer-planets missions are an adaptable data-handling system and a self-testing and repairing computer
Alfred Rosenblatt,
Electronics staff
- Data handling** 116 **Synchro-to-digital converters: Pick the one that fits the job**
Trackers handle high angular velocities; samplers respond to step changes; each type has its own virtues and vices
Frederick Roberts,
North Atlantic Industries
- Departments**
- | | | | |
|----|--------------------------|-----|--------------------------|
| 4 | Editorial Comment | 33 | Electronics Newsletter |
| 5 | Readers Comment | 67 | International Newsletter |
| 9 | Who's Who in this issue | 81 | Washington Newsletter |
| 14 | Who's Who in electronics | 152 | Technical Abstracts |
| 22 | Meetings | 152 | New Books |
| | | 153 | New Literature |

Electronics

Editor-in-Chief: Donald Christiansen

Senior staff editors

Technical: Stephen E. Scrupski

News: Robert Henkel

International: Arthur Erikson

Art director: Gerald Ferguson

Assistant managing editors: H. Thomas

Maguire, Howard Wolff, William Bucci,

Richard Gundlach, Frederick Corey

Special projects editor: Roger Kenneth Field

Senior staff writer: John Johnsrud

Reader Communications manager: John D.

Drummond

Department editors

Senior associate editor: Joseph Mittleman;

Advanced technology: Laurence Altman; Com-

munications: Leon M. Magill; Computers: Wal-

lace B. Riley, George Weiss; Design theory:

Joseph Mittleman; Instrumentation: Owen

Doyle; Military/Aerospace: Alfred Rosenblatt;

New Products: William P. O'Brien; Solid state:

George Watson, Stephen Wm. Fields.

Copy editors: Edward Flinn, William S. Weiss

Assistant art director: Charles Ciatto

Production editors: Susan Hurlburt, Arthur C.

Miller; Editorial research: Virginia Mundt; Edi-

torial secretaries: Claire Goodlin, Bernice

Pawlak, Barbara Razulis, Vickie Green, Terri

O'Neill.

Field bureaus

Boston: James Brinton, manager; Gail Farrell;

Los Angeles: Lawrence Curran, manager; Ralph

Selph; New York: Peter Schuyten; San Fran-

cisco: Stephen Wm. Fields, Marilyn Howey;

Washington: Ray Connolly, manager; Robert

Westgate, Lois Vermillion; Frankfurt: John

Gosch; London: Michael Payne; Paris: Arthur

Erikson; Tokyo: Charles Cohen

Reprints: Virginia Mundt; Circulation: Isaaca

Siegel

Publisher: Dan McMillan

Assistant to the publisher: Wallace C. Carmichael

March 30, 1970

Japan's tight labor market—a blessing in disguise

● The Japanese electronics industry is riding the crest of a wave that was generated by its own unprecedented growth and is sustained by a strong sense of national purpose. That alone undoubtedly would guarantee rapid application of advanced technology to finished products; ironically, Japan's labor shortage may be helping even more. Japanese companies are pressing development of IC's for television and LSI for calculators and computers not only to cut costs and increase reliability, but also to eliminate assembly steps for which manpower is critically short.

Thus, Sony's use of ceramic filters in its radio sets to replace i-f transformers permits doing without assembly-line workers who formerly were needed to align the receivers. Similarly the four-IC design of Sharp's microcalculator reduces its otherwise labor-intensive assembly process to a simple task. Japanese color-set makers are also anxiously awaiting development of a "jungle-circuit" IC that can replace the myriad components now included in the video detector, sync separator, agc, horizontal afc, vertical and horizontal oscillators, and perhaps even the chroma demodulator circuits.

A corollary effect of the worker shortage is the trend to semiautomation. On the one hand, labor in Japan has not priced itself out of the market, and as a result the electronics industry is anxious to use all the manpower it can get. Yet scarcity dictates the use of mechanical and electronic aids to boost worker productivity. So, for example, at NEC's computer plant in Fuchu, a bank of semiautomatic wire-wrap machines slashes the need for many operators. And at Fujitsu's Kawasaki plant, a battery of girls

wires subassemblies for numerical-control computers, aided by flashing x-y section locators and a sequencing readout that defines both wire length and the exact pair of terminals to be connected.

While Japanese engineers work overtime on schemes such as these to simplify and speed up production, managers plot ways to best utilize the Japanese labor force. Often they must import workers from scattered farm communities to a central factory. At Sanyo's color-set plant in Gifu, 1,600 of the 2,150 girls who work there live in company-run dormitories. Sanyo also houses 296 male employees within its complex, as well as a few family groups. The dormitory-based workers are mainly junior and senior high school graduates for whom industry recruiters have waited impatiently. Most have an opportunity to continue their education under company subsidy.

Few firms profess enthusiasm for operating a hotel business. Nevertheless, the community spirit generated among employees as a result of working and living together reinforces their enthusiasm for corporate paternalism. It is reflected in pride of workmanship and product quality, and makes high-production and zero-defects programs easier to administer. The live-in employees eat their meals at dormitory cafeterias, and play volleyball, basketball, and swim at company facilities within the manufacturing complex. (Managers and workers alike at Hitachi's Kodaira-Shi semiconductor plant, where 2,400 of its 3,500 female employees live, are proud that members of its girl's volleyball team formed the nucleus of Japan's silver-medal Olympic team.)

Some companies, like Fujitsu, for example, expect to

Published every other Monday by McGraw-Hill, Inc. Founder: James H. McGraw 1860-1948. Publication office 99 North Broadway, Albany, N. Y. 12202; second class postage paid at Albany, N. Y. and additional mailing offices.

Executive, editorial, circulation and advertising addresses: Electronics, McGraw-Hill Building, 330 W. 42nd Street, New York, N. Y. 10036. Telephone (212) 971-3333. Teletype TWX N. Y. 710-581-4235. Cable address: MCGRAWHILLN.Y.

Subscriptions solicited only from those professionally engaged in electronics technology. Subscription rates: qualified subscribers in the United States and possessions and Canada, \$8.00 one year, \$12.00 two years, \$16.00 three years; all other countries \$25.00 one year. Non-qualified subscribers in the U.S. and possessions and Canada, \$25.00 one year; all other countries \$50.00. Air freight service to Japan \$50.00 one year. Single copies: United States and possessions and Canada, \$1.00; all other countries, \$1.75.

Officers of McGraw-Hill Publications Company: Joseph H. Allen, President; John R. Emery, J. Elton Tuohig, Senior Vice Presidents; Gordon L. Jones Jr., Group Vice President; Vice Presidents: John R. Callahan, Editorial; John M. Holden, Marketing; David G. Jensen, Manufacturing; Jerome D. Luntz, Planning & Development; Robert F. Marshall, Administration; Robert M. Wilhelm, Finance; Director of Circulation: Ralph Blackburn.

Officers of the Corporation: Shelton Fisher, President and Chief Executive Officer; John J. Cooke, Senior Vice President and Secretary; Gordon W. McKinley, Vice President and Treasurer. Title © registered in U.S. Patent Office; © Copyright 1970 by McGraw-Hill, Inc. All rights reserved. The contents of this publication may not be reproduced either in whole or in part without the consent of copyright owner.

Subscribers: The publisher, upon written request to our New York office from any subscriber, agrees to refund that part of the subscription price applying to copies not yet mailed. Please send change of address notices or complaints to Fulfillment Manager; subscription orders to Circulation Manager, Electronics at address below. Change of address notices should provide old as well as new address, including postal zip code number. If possible, attach address label from recent issue. Allow one month for change to become effective.

Postmaster: Please send form 3579 to Fulfillment Manager, Electronics, P.O. Box 430, Hightstown, New Jersey 08520.



circumvent the need for additional residential buildings by constructing small plants in carefully selected smaller towns (as, for example, a 500-employee plant in a community of 20,000 people). The big Japanese firms sometimes set up satellite plants and operate them as subsidiaries under an obscure name, reaping the benefits of a labor rate that's less than it would be under the aegis of the better-known parent.

Still another approach to solving the labor shortage is the establishment of overseas manufacturing plants. Toshiba employs 200 workers in a Mexican semiconductor facility in which it holds majority ownership. The company is bringing another plant on line in South Korea. Even in these remote locations Toshiba envisions rising labor costs. It therefore expects to quickly install semiautomatic assembly equipment to guarantee high productivity.

Do Japanese employees view automation as a threat to their jobs? Apparently not. Perhaps slogans like "Advanced technology creates unending demand" and "Jobs done right create prosperity" that are displayed prominently over their production lines help allay such fears.

Not too surprisingly, the unions in Japan generally are sympathetic to manpower problems, and do not balk unduly when schemes to simplify products and cut labor content are proposed. Furthermore, workers in Japan are well-versed in national objectives; they are imbued with the necessity for competing on an international scale. In the end, the very scarcity of their numbers may help Japan surge ahead of the U.S. in the incorporation of advanced technology into electronic products.—D.C. ●

McGraw-Hill News Service

Director: Arthur L. Moore; **Atlanta:** Fran Ridgway; **Chicago:** Robert E. Lee; **Cleveland:** Arthur Zimmerman; **Dallas:** Marvin Reid; **Detroit:** James Wargo; **Houston:** Barbara LaRoux; **Los Angeles:** Michael Murphy; **San Francisco:** Margaret Drossel, Tyler Marshall; **Seattle:** Ray Bloomberg; **Washington:** Charles Gardner, James Canan, Herbert W. Cheshire, Seth Payne, Warren Burkett, William D. Hickman; **Bonn:** Robert F. Ingersoll; **Brussels:** James Smith; **Hong Kong:** Kate Mattock; **London:** John Shinn; **Mexico City:** Gerald Parkinson; **Milan:** Jack Star; **Moscow:** Jack Winkler; **Paris:** Robert E. Farrell, Stewart Toy; **Tokyo:** Marvin Peta

Radar braking

To the Editor:

I was greatly astonished to read the article on radar braking [Jan. 5, p. 155]—it describes a system which I invented, developed and patented. The article constitutes an unauthorized disclosure of patented, proprietary technical details which cost me more than \$2.5 million and 16 years of work to develop.

I made the details available to Bentley Associates Inc. through a contract in September 1968. Bentley was to expedite product engineering for me for mass production. The company was unable to meet the terms of my contract and hence defaulted. I still hold an offer from Bentley, dated May 1969, to grant the company license to manufacture the system and to provide Bentley with consultation on product improvement; but, I have not chosen to accept it.

George E. Rashid

Rashid Automatic Radar Brake Co.
Detroit

■ Paul D. Flannery, vice president of Bentley Associates, replies that the company did indeed enter into a contract with Rashid in September 1968 to provide certain services and goods. But, according to Flannery, "At no time did Rashid provide us with any information or material of a proprietary nature." Bentley's only knowledge of the Rashid invention came through public disclosure of his patent, Flannery adds, asserting that Rashid defaulted on the contract with Bentley. The system described in the article "was developed by Bentley using exclusively its own resources and capabilities," Flannery says, adding that the Bentley system "is unique in its objectives and technique."

According to Flannery, Bentley did offer to enter into licensing agreement with Rashid with the idea that Bentley's "expertise could be applied at a later date to make the Rashid invention a practical system resulting in a product which would complement our Bentley product line." However, says Flannery, that offer was withdrawn when Bentley became aware of a recent patent (U.S. 3,448,822 issued to Francis G. and Frank R. La Lone) which the company says represents a "substantial improvement" over the Rashid invention.

Shipsape

To the Editor:

With regard to your article on the Queen Elizabeth 2 [Feb. 2, p. 104], there are some inaccuracies concerning the notch antennas. Contrary to what your article states, the notches have been fully operational for over

(Continued on p. 6)

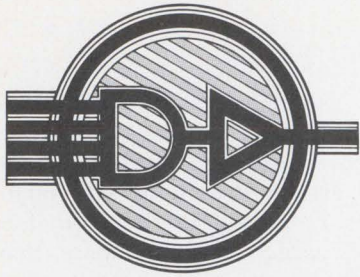

28V DTL POWER GATE

Problem: Find 28 volt 4-input DTL power gate immune to 80 volt transients.

Solution: The Siliconix H-100 Dual Power Gate, offers high AC and DC noise rejection and operates directly from 28 volt power supplies.

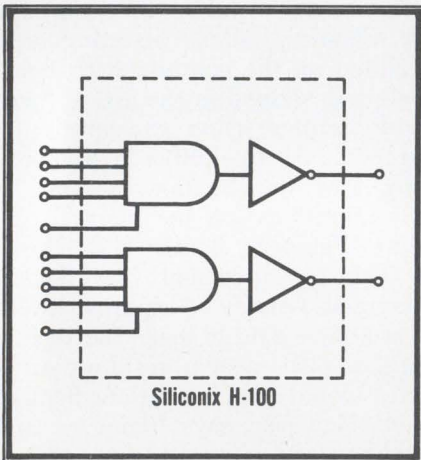

The H-100 was developed for use with noisy aircraft and marine power supplies; output drives 100 mA and sustains 90 volts. Available in TO-86 or TO-116 packages. Write or call today for the data sheet on the Siliconix H-100!

Siliconix
incorporated

2201 Laurelwood Rd. • Santa Clara, Calif. 95054
(408) 246-8000 Ext. 201 • TWX: 910-338-0227

Readers Comment

six months. The bolts that "reportedly glowed red" had nothing to do with "holding the notch." They were simply the bolts used to secure the contacts on a prototype relay that was undergoing proving tests. The manufacturer had inadvertently used steel bolts instead of brass. And, of course, they got hot due to r-f heating. The capacitors and relay that failed did so before we were informed that the transmitters were producing more than six times the power for which the notches were designed. Since the upgrading of the antennas, no overheating problems have been experienced.

Your article gives the impression that a radio operator must perform prodigious gymnastic feats while trying to tune the couplers and the notches to the transmitters. The notch controls, which are situated adjacent to the relevant transmitter controls, only require the operator to set two switches and a dial—a task easily performed "while chewing an apple."

P.T. Veness

England

▪ The article didn't say the notch antennas didn't work. It merely traced the problems concerning the antennas and pointed out that radio operators preferred not to use them.

Nipper's new master

To the Editor:

I think you will be pleased to know that Nipper, who Roger Kenneth Field reported [March 2, p. 101] had been "kicked out" by his employer, RCA, is alive and well and living in Japan. His image adorns high fidelity Audiola stereo equipment and Victor Vision television sets sold by the Victor Company of Japan Ltd. Furthermore, Nipper sits faithfully atop innumerable sets throughout dealer showrooms across Japan, with head cocked, still listening for his master's voice.

Edward Mueller

Tokyo, Japan

▪ Nipper is indeed working for the Victor Company of Japan, which, incidentally, has had no connection with RCA since the second world war. It just proves that you can't teach an old dog new tricks, or perhaps that you can't keep a good dog down.

Readers' letters should be addressed:

Electronics

To the Editor

330 West 42nd Street, New York,
N.Y. 10036

A change in command

Those subscribers who read our masthead—in its customary place at the top of page 4—will notice an important change. Gordon Jones, who has guided the progress of *Electronics* for the past four years, is no longer publisher. A group vice president for the McGraw-Hill Publications Company since 1969, he has been named to head an important new group—Management Information Services.

Succeeding Gordon Jones as publisher of *Electronics* is Dan McMillan, associate publisher since August 1969. No stranger to the magazine, Dan McMillan started with *Electronics* in 1956 and served as district manager until 1961 when he joined the electronics group of TRW Inc. During his eight years with TRW, he served in various management positions, most recently as general manager of the United Transformer division.

Our best wishes go to Gordon Jones in his new position. And it is with pleasure that we welcome Dan McMillan as publisher of *Electronics*.

Editor-in-Chief

D/A CONVERTERS

10-BIT D/A



5 BUCKS/BIT

A HYBRID CIRCUIT
PRICE/PERFORMANCE
BREAKTHROUGH.

Check these specs:

- $\pm 1/2$ LSB accuracy
- 100 kHz bit rate
- 25 k Ω output impedance
- 5 ppm/ $^{\circ}$ C T_C max.
- 0 to +70 $^{\circ}$ C operating temperature

Now you can get a complete thin-film 10-bit D/A converter—buffer amp, ladder switch, and tantalum nitride ladder network—all in a single package with DIP compatible pinning. And for \$5.00 per bit.

We've also got a 4-bit D/A, a 4-bit expander module to get 8 bits, and a three package kit to get 12 bits.

Find out about all of them.

PRICE? DELIVERY? LOCAL DISTRIBUTORS? TECHNICAL LITERATURE?
GET THE ANSWERS AT ANY OF THE NUMBERS LISTED BELOW.

ALA. Huntsville, no charge call operator, WX4000 ARI. Phoenix (602) 279-5435 CALIF. Burlingame (415) 347-8217 Los Angeles, Bell Tel., (213) 870-0161, Gen. Tel., (213) 391-0611 San Diego (714) 278-7640 COLO. Denver (303) 756-3611 CONN. Trumbull (203) 261-2551 DC. Washington (202) 244-6006 FLA. Orlando (305) 831-3636 ILL. Schiller Park (312) 678-2262 IND. Indianapolis (317) 546-4911 MASS. Newton (617) 969-7640 North Adams (413) 664-4411 MICH. Ann Arbor (313) 761-4080 Detroit, no charge call operator, Enterprise 7498 MINN. Minneapolis (612) 335-7734 MO. St. Ann (314) 291-2500 NJ. Cherry Hill (609) 667-4444/(215) 467-5252 Wayne (201) 696-8200 NY. Melville (516) 549-4141 Syracuse (315) 437-7311 NC. Winston-Salem (919) 722-5151 OHIO Chagrin Falls (216) 247-6488 Dayton (513) 223-9187 Cincinnati, no charge call operator, Enterprise 3-8805 TEX. Richardson (214) 235-1256 WASH. Seattle (206) 632-7761.

4SS-9189R2

SPRAGUE

THE MARK OF RELIABILITY

the little things that count... in the Big Time.



Sub-miniature and miniature **events counters** and **elapsed time indicators**... with such high reliability that they set the industry's standards. With such myriad capabilities that they lend themselves perfectly to state-of-the-art applications: Space exploration; communications equipment; aircraft controls; computer technology; automated systems; laboratory procedures. Think of your own applications. If you require a little counter to tell you *how many*... or a little timer to tell you *how long*... chances are you're ready for the Big Time.

For additional information, contact:

SPACE AND SYSTEMS
DIVISION



GENERAL TIME
Progress in the World of Time

1200 HICKS ROAD, ROLLING MEADOWS, ILL. 60008 / (312) 259-0740

BITE INDICATORS • ROTARY SWITCHES • TRIMMER POTENTIOMETERS • ELAPSED TIME INDICATORS • EVENTS COUNTERS



Who's Who in this issue



Brinton

Journalism and electronics are the winning combination for both the article that starts on page 123 and for James Brinton, who wrote it, with substantial assists from *Electronics*' field offices. Manager of *Electronics*' Boston bureau, Brinton entered the Navy after a 1960 graduation from Washington University, St. Louis, where he studied English and physics. He worked on the Polaris program before leaving the Navy to pursue journalism.

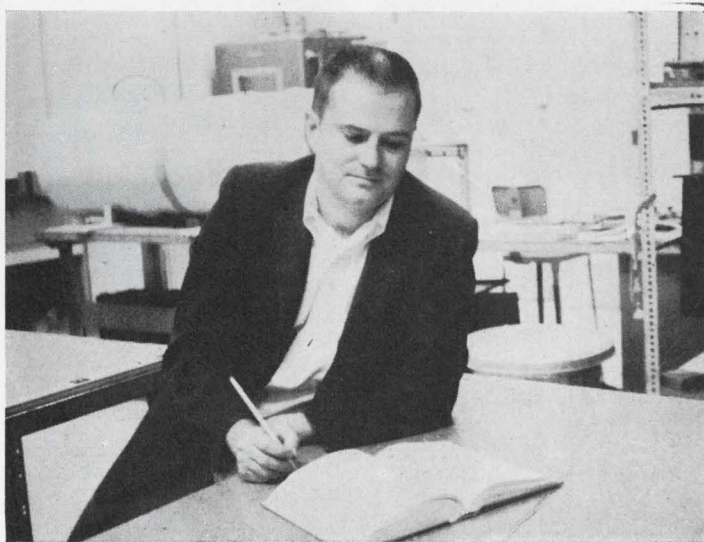

Zobrist

"Get involved" could serve as a motto for George Zobrist, author of the article on computer-aided design programs that begins on page 98. As a consultant to the Bendix Corp. and the Wilcox Co., he focused on applying the computer to engineering design problems. Now, at the University of South Florida, he is active in organizing seminars on CAD, and has lectured on the subject at several American and foreign universities and institutes.



Roberts

Selling wasn't exactly a burning ambition of Frederick Roberts, author of the article starting on page 116. He recalls "telling my father I didn't want to be a salesman." But Roberts took a sales job while a student at the Polytechnic Institute of Brooklyn. He's now vice president, marketing, at North Atlantic Industries.



Rosenblatt

A natural choice to write the article on the thermoelectric outer planets spacecraft that begins on page 108 was Alfred Rosenblatt, who is *Electronics*' military/aerospace editor. Rosenblatt graduated from Cooper Union School of Engineering and studied at Columbia University's Graduate School of Journalism.

Teamwork between industry and editors was the factor that contributed most to the article that begins on page 86. Groups of *Electronics*' editors conducted round-table discussions attended by product planners from companies all around the nation. George Watson of *Electronics*' staff put it all together.

Why the bankers gave us the money:

From left: W. Jerry Sanders III, President and Chairman of the Board. D. John Carey, Managing Director of Complex Digital Operations. Sven E. Simonsen, Director of Engineering, Complex Digital Operations. Frank T. Botte, Director of Development, Analog Operations. James N. Giles, Director of Engineering, Analog Operations. Edwin J. Turney, Director of Sales and Administration. Jack F. Gifford, Director of Marketing and Business Development. R. Lawrence Stenger, Managing Director, Analog Operations.



At a time when credit couldn't get any tighter without twanging, when the semiconductor industry needed another bunch of hotshots like you need a power failure, a new company got the Bank of America, Schroder Rockefeller, The Capital Group, Inc. and Donaldson, Lufkin & Jenrette to give it enough cash, enough credit, enough commitment to make the new company a serious marketing factor before its first anniversary.

This is what we told them:

1. **We are hotshots.**

If you have to call us names, that's as good as any other.

As individuals and as a growing team, the members of this company invented circuits, processes and markets. Each has had a serious technical or marketing position with a major semiconductor firm. Each has his own commitment to excellence.

Let's face it: That's why we got together.

2. **We know what we're doing.**

We're in the large chip MSI and LIC business. Period. No jelly beans. No 10,000-gate freaks. Only the tough-to-make, easy-to-utilize mainstream circuits.

We selected the best people in the business to build (to our specifications) a processing facility that was optimized for the precise, complimentary process control requirements of complex, high performance digital and linear integrated circuits.

We decided to make only one quality of circuit: mil spec reliability or better. By this concentration of technical resources, we're able to get yields that let us sell circuits which meet the most stringent military

reliability requirements and the equally stringent pricing requirements of the commercial market.

And it feels so good, we're going to keep it up.

Oh, yes. Out of our checkered pasts we remembered that there was a kind of annoying difference between employees and owners. So we fixed it. Every employee here is an owner. (As a matter of fact, every owner is an employee except for the bankers.)

3. **We know who you are.**

You're in the fastest-growing part of the market; probably the computer and peripheral equipment business.

You've been had by experts, so you're ready to listen when we say:

We'll never announce a product that isn't in high volume production, in-house qualified through documented electrical and mechanical life testing, 100% stress tested to MIL STD 883 and in inventory.

The other reason we got the money is that we told the bankers we'd introduce complete product lines—digital and linear—for sale in volume before we are a year old.

And we will.

Advanced Micro Devices Inc.

901 Thompson Place, Sunnyvale, California 94086
Established May 1, 1969

Advanced Micro Devices has perfected the production technology of complex, mainstream digital and linear monolithic circuits.



Circle 11 on reader service card



UOP
NORPLEY
LINT-PICKER

The Lint-Pickers open a new plant!

And look what's in it for you!



When demand exceeds supply, something's got to be done. And UOP Norplex did it.

To meet your growing needs for laminates, we've opened our new, all-modern, 50,000-square-foot plant in Franklin, Indiana.

Adding to the production capabilities of our large plants in LaCrosse and Black River Falls, Wisconsin, this centrally-located facility will also speed up service on the Norplex laminates you depend on: multi-layer, copper-clad and unclad.

This new plant features the most modern laminating equipment and the finest technology in the industry. And you can be sure Norplex at Franklin will carry on the "Lint-Picker" tradition of continuing research and complete quality control.

UOP Norplex is a division of Universal Oil Products Company, a half-billion dollar company busy making life better through research and product innovation around the world.

Write for our latest catalog. It's designed to help engineers select the right laminates for every need.

<i>Main Office and Plant</i>	<i>Franklin Office and Plant</i>
Norplex Drive	P.O. Box 186—Route 31 North
LaCrosse, Wisconsin 54601	Franklin Industrial Park
608/784-6070	Franklin, Indiana 46131
	317/736-6106



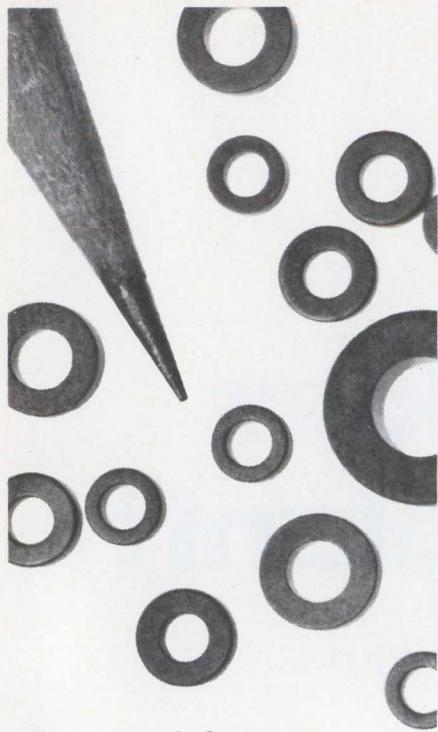

How much better
will a pulse-tested
5000 perm toroid
perform in your
transformer?

WE'D LIKE TO
SHOW YOU SOME DATA.

Pulse testing gives your pulse transformer consistent performance. It's not a guessing game anymore.

You know how consistency in a ferrite toroid can boost the performance of your product because you know transformers. And we know toroids. They're our specialty.

We'd like to show you the data and rely on your good judgment. Our business is built on the belief that good designers are the best judges.

Six standard sizes from .100" to .375". Available with parylene coating.

**FERRONICS
INCORPORATED**

66 North Main Street, Fairport, New York 14450

14 Circle 14 on reader service card

Who's Who in electronics

"If things were smooth, life would be pretty dull." With that understatement, Donn Williams, 49, approaches his task of rebuilding morale and credibility as a price competitor for military and commercial business, and channeling new business potential at the Autonetics division of the North American Rockwell Corp., where he recently became president.

Williams, an aeronautical engineer, succeeds the more aloof S.F. Eyestone, who was relegated to an engineering vice presidency at NR's aerospace and systems office in a January shakeup. The earthier Williams was most recently senior vice president for resource management of the former Aerospace and Systems group. He was with Autonetics continually from 1950 through 1964, when he left to become president of Tamar Electronics Industries. He returned to Autonetics in 1965 as assistant to the president. His rise through the ranks is attributed by some to his reputation for being something of an efficiency expert.

He believes, contrary to many who are sounding the death knell for Autonetics, that present contracts will keep the division going for two to three years, and that new business will come, although it won't necessarily be big-ticket hardware.

Missile moving. Williams is satisfied that the Minuteman 3 guidance-system program "will move in a positive direction" even though Honeywell is trying to qualify as a second source because of recent management changes—including wholesale layoffs. It's now easier to find out where problems exist since all guidance elements at Autonetics were recently brought under one general manager. Says Williams, "I think the problems we've had on Minuteman stemmed from the program being diffused throughout a number of divisions, which made coordination a problem." But he's less specific about the F-111 avionics program, probably because there's a good chance further production of the plane will be halted.

Still on the military side, Wil-



Williams

iams says, "We're making a big effort to win the B-1 avionics; but, even if the program goes and Autonetics wins, we're talking about a small number of aircraft." Thus, although the major effort is being devoted to satisfying present customers, plus honing the organization to win the B-1 avionics contract, Autonetics under Williams will push hard for smaller programs that might be worth \$10 million to \$20 million a year to the firm.

In commercial microelectronics, Williams speaks candidly of start-up problems affecting the process and yields on the Autonetics Products division's contract to deliver more than 2 million MOS arrays to the Sharp Corp. of Japan. But, these have been solved, he says. "We delivered in February three times the number of circuits we did three months ago, and Sharp is producing tens of thousands of calculators per month."

His title is director of medical research, but Dr. Allen Wolfe's real job with the Barnes Engineering Co. of Stamford, Conn., is selling

Beckman 136MHz \$1375.*

Universal Counter and Timer
Fully Programmable
Field Replaceable ICs
Signal Level Indicators

Two Counters in One • Burst Mode • Frequency • Period • Single-Channel Pulse Width & Pulse Separation • Two-Channel Time Interval • Multiple Period • Ratio • Multiple Ratio • 25 μ s Recycle Time

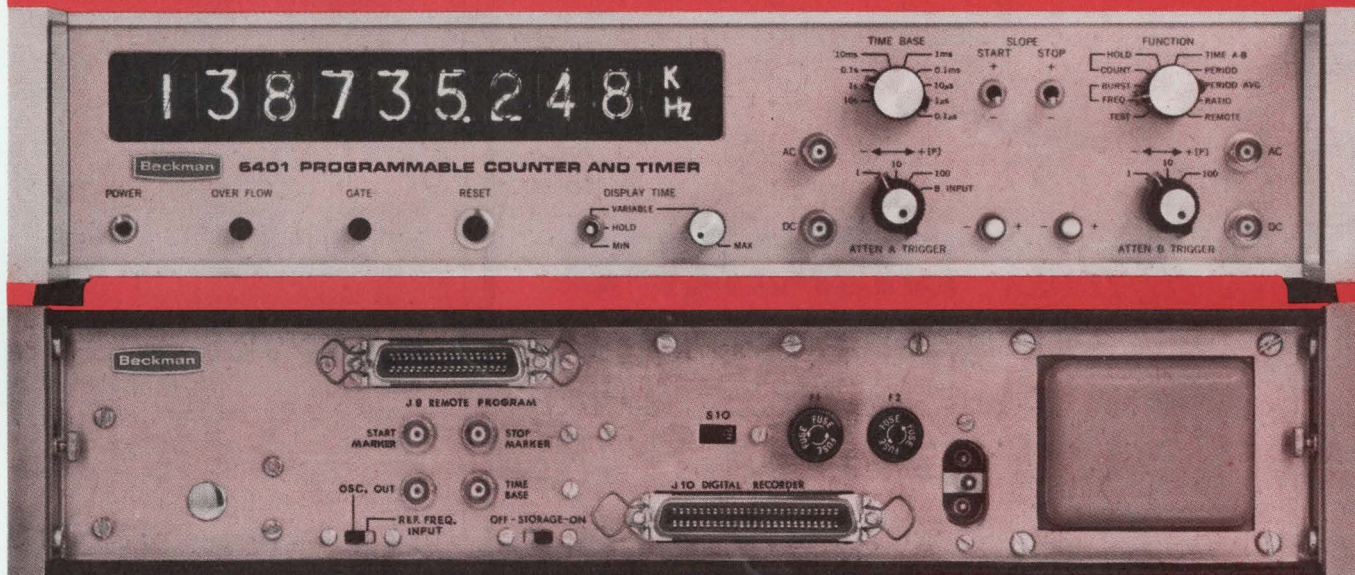

*NOW! THE NEW 6401A WITH 10NSEC TIM AND PERIOD MODES... \$1875.

Beckman®

INSTRUMENTS, INC.
ELECTRONIC INSTRUMENTS DIVISION
RICHMOND, CALIFORNIA • 94804

Place your order for the Model 6401 with your local Beckman representative:

Barnhill Associates • Denver, (303) 934-5505 • Albuquerque, (505) 265-7766 • Phoenix, (602) 263-1250 • Houston, (713) 621-0040 • Richardson, (214) 231-2573 • Salt Lake City, (801) 487-1327 • BCS Associates, Inc. • Orlando, (305) 843-1510 • Greensboro, (919) 273-1918 • Huntsville, (205) 881-6220 • Williamsburg, (707) 229-6198 • Plantation, Fla., (305) 584-7556 • Burlingame Associates, Ltd. • Mount Vernon, (914) 664-7530 • New York City area, (212) 933-5555 • Rockville, (301) 427-1255 • Bala Cynwyd, (215) 835-2080 • Syracuse, (315) 454-2408 • New York State, Enterprise 9-6400 • Moxon Electronics • Los Angeles, (213) 272-9311 • Sunnyvale, (415) 734-4352 • San Diego, (714) 274-6525 • Pivan Engineering • Chicago, (312) 539-4838 • Cedar Rapids, (319) 365-6635 • Mission, Kansas, (913) 722-1030 • Indianapolis, (317) 253-1681 • St. Louis, (314) 872-8424 • Minneapolis, (612) 537-4501 • Brookfield, (414) 786-1940 • Seatronics, Inc. • Seattle, (206) 767-4330 • S. Sterling Company • Cleveland, (216) 442-8080 • Pittsburgh, (412) 922-5720 • Dayton, (513) 298-7573 • Southfield, (313) 357-3700 • Yewell Electronic Sales, Inc. • Lexington, (617) 861-8620 • Easton, (203) 261-2241 • Beckman Instruments, Inc., Electronic Instruments Division, Richmond Operations, (415) 526-7730

INTERNATIONAL SUBSIDIARIES: AMSTERDAM; CAPE TOWN; GENEVA; GLENROTHES, SCOTLAND; LONDON; MEXICO CITY; MUNICH; PARIS; STOCKHOLM; TOKYO; VIENNA

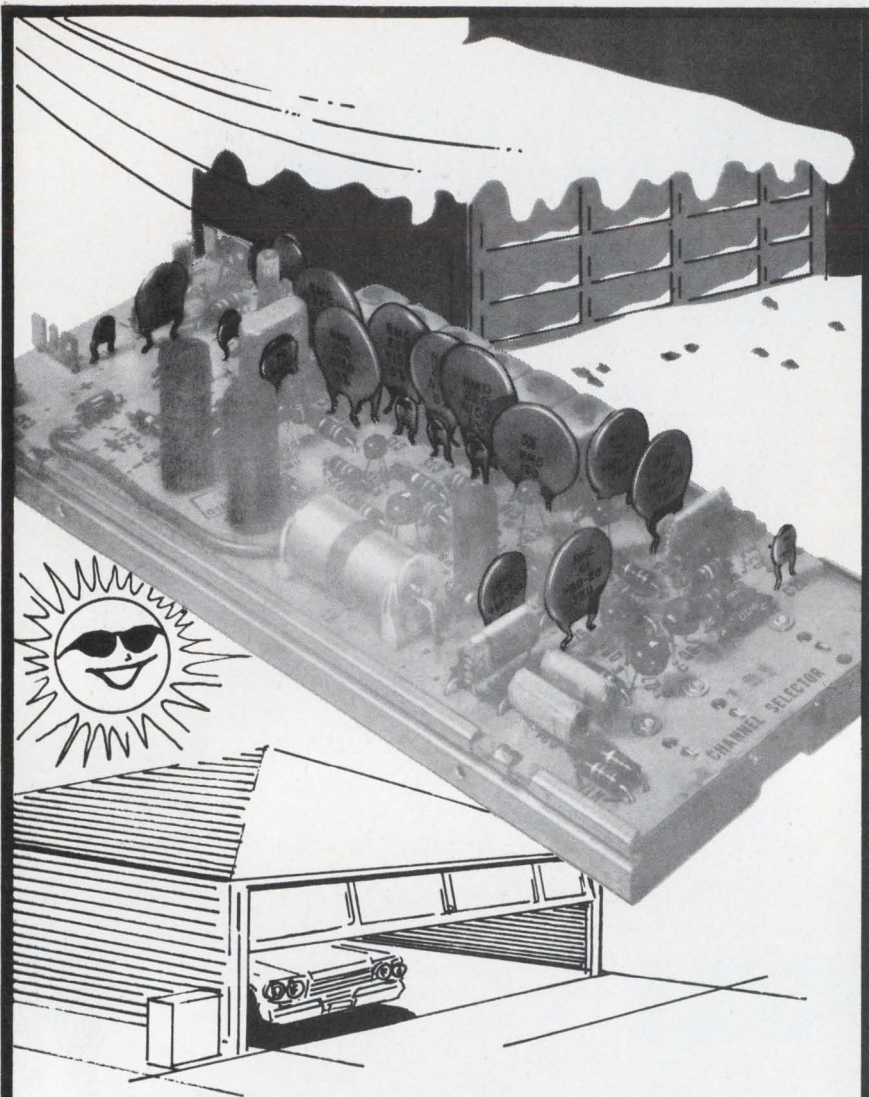

RMC DISCAPS FOR TEMPERATURE SENSITIVE APPLICATIONS

Perma-Power, a division of Chamberlain Mfg. Corp., a leading manufacturer of radio controlled garage door openers, specifies RMC DISCAPS to assure reliability under extreme environmental conditions.

RMC produces a full range of DISCAPS for temperature sensitive circuitry or applications requiring exact temperature compensation. Frequency and temperature stable types, as well as units of predictable variability, are available.

DISCAPS are produced to the highest standard of quality and may be specified with complete confidence.

If your application requires special physical or electrical characteristics, contact RMC's Engineering Department.

Write today on your company letterhead for your copy of the complete RMC catalog.

DISCAP
CERAMIC
CAPACITORS



RADIO MATERIALS COMPANY
A DIVISION OF P. R. MALLORY & CO., INC.
GENERAL OFFICE: 4242 W. Bryn Mawr Ave., Chicago 46, Ill.
Two RMC Plants Devoted Exclusively to Ceramic Capacitors
FACTORIES AT CHICAGO, ILL. AND ATTICA, IND.

thermography to physicians. If they accept infrared scanning as a diagnostic tool, Barnes would sell a lot of medical thermographs because only one other company, the AGA Corp., competes with the Connecticut firm in the U.S.

A thermograph like Barnes' [*Electronics*, Aug. 5, 1968, p. 221] focuses infrared radiated by an object onto a detector, whose output current modulates the intensity of the electron beam in a cathode-ray tube. The result is a picture showing hot areas as dark spots and cooler ones as lighter regions. Since many diseases and injuries cause characteristic temperature changes in the tissue around them, doctors use thermography to locate or identify such things as tumors and arthritic joints.

Not a be-all. In fact, the long list of suggested applications makes the thermograph sound like a valuable tool. Another virtue is that the technique is totally passive; no radiation shoots through the patient and no needles are stuck into him. With these features to point to, Wolfe, himself an internist, should have an easy job. He doesn't. The technique is new; since few doctors have heard of it in medical school, they're skeptical. And because it's new, there's very little documentation and guidelines about what it can and can't do. Back in the early 1960's some physicians thought it could do almost anything and said so. When thermography couldn't live up to their promises, the approach was discredited. Wolfe's biggest task is to wipe off this snake oil.

Referring to one of the early claims, he says: "You can't diagnose cancer with a thermograph; it just gives the physician information for his diagnosis."

Among Wolfe's jobs at Barnes is talking to prospective customers. With money getting tighter, particularly in research, Wolfe is changing Barnes' sales approach. "We used to stress the research aspect of thermography," he says, and tell the user how he could "lead the way into tomorrow." Now the emphasis is on what thermography can do today and how it can make money for the doctor.

Macrodata introduces topographical LSI.

"Topographical LSI is a completely new approach to the design of MOS/LSI chips and wafers. The design technique is based on the constraints of the device and process parameter rules rather than the performance parameters. With Topographical LSI and Macrodata's CADIS (Computer-Aided Design Information System), we are designing and producing chips in six weeks compared to six months for present logic cell techniques.

Since one man, with CADIS, controls the whole Topographical process from design through artwork generation, both design integrity and "in-house" control are maintained. Best of all, 'Topo' LSI gives you the possibility of multiple vendor sources for actual wafer processing.

If you would like to know more about Topographical LSI, call me personally, or write for free brochure describing 'Topo' LSI in detail."

DR. WILLIAM C. W. MOW
PRESIDENT
MACRODATA COMPANY

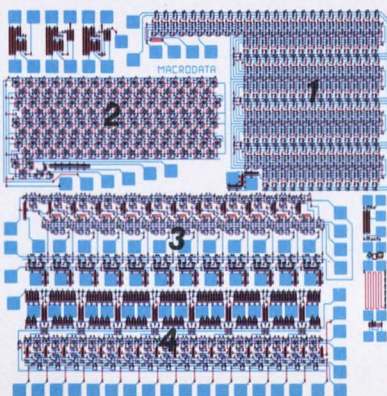

TEST CHIP

1. 128 bit 4 phase dynamic shift register with static hold.
2. 64 bit 2 phase shift register, 5MHertz.
3. 12 bit accumulator.
4. 16 bit counter.



COMES WITH EVERY
GENERAL ELECTRIC
CAPACITOR

Reliability through people

Capacitor reliability, just like the reliability in your aerospace equipment, is only as good as the people behind the product. At General Electric capacitor reliability is built in, start to finish, by quality-oriented people, assuring the dependability you require in your equipment design.

Reliability starts with our Research and Development teams. These inquisitive and creative people, who have greatly advanced electrolytic capacitor technology, are continually exploring materials and methods to develop new and better ways to meet your needs.

It continues with the involvement of scores of men and women who subject capacitors to exhaustive quality control during manufacture, with units receiving hundreds of quality checks.

It concludes with exacting test people who precisely verify capacitor performance through rigorous test procedures.

Reliability comes from people like these . . . in research, design, quality control, manufacturing and testing. People who share your pride in producing reliable equipment . . . and do something about it.

To learn more about reliable GE capacitors through people, contact one of the "problem solvers" — your GE Electronic Distributor or ECSO District Sales Manager. Or write Section 430-43, General Electric Company, 1 River Road, Schenectady, N. Y. 12305.

Electronic Capacitor and Battery Dept., Irmo, S. C.

GENERAL  ELECTRIC

Circle 18 on reader service card

Tantalum Foil

Tubular or Rectangular
Meets or exceeds performance and environmental requirements of MIL-C-3965.

For polar and nonpolar applications in military and high-performance industrial equipment.

- Voltage range . . . Up to 450 VDC
- uf range 0.15 to 3500 uf
- Temp. range . . . — 55C to 85C or 125C

Tantalum Wet-Slug

Tubular or Rectangular
Meets or exceeds performance and environmental requirements of MIL-C-3965.
Used in military and high-performance industrial systems.

- Voltage range . . . Up to 125 VDC
- uf range 1.7 to 2400 uf
- Temp. range . . . — 55C to 85C and up to 125C

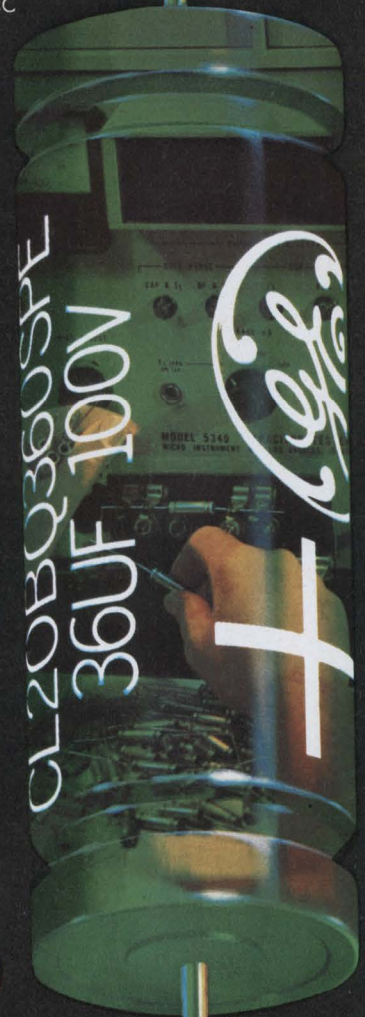
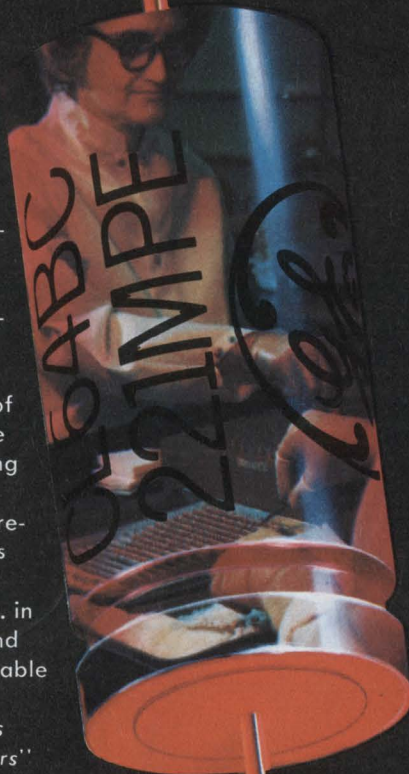

**High-Reliability Tubular
Tantalum Foil**

Tantalum to glass true hermetic seal.
For military or aerospace use where
outstanding performance and
reliability are prime factors. Meets or
exceeds performance and environ-
mental requirements of MIL-C-39006

- Voltage range . Up to 200 VDC
- uf range 1.2 to 450 uf
- Temp. range -55C to 125C

Polyester Film Foil

With axial leads meets or
exceeds performance and
environmental requirements of
MIL-C-27287. Use where size,
weight, cost and reliability
offers an advantage over metal-
clad tubulars, molded or
ceramic case units.

- Voltage range . Up to 300V
- uf range0010 to 1 uf
- Temp. range -55C to
125C



**Subminiature Tantalum
Wet-slug Capacitor**

In military and high-perform-
ance industrial miniature
applications where an extremely
small unit with highest
volumetric efficiency is required.

- Voltage range . Up to 60 VDC
- uf range 3.3 to 450 uf
- Temp. range -55C to 85C

Now there's a pack Everything includ plant or ours.

Our plan is whatever you want to make it. It can be everything you need for your panels. Or just some of the things.

We can start serving you at the design stage. Or we can provide components to meet your designs. We can supply all the wiring, too. Our own **TERMI-POINT*** point-to-point automatic wiring system that works with solid or stranded wire, and is easily maintainable. Your capital investment to get your panels wired with our method is zero. Whether you wire in your plant or we do it in ours.

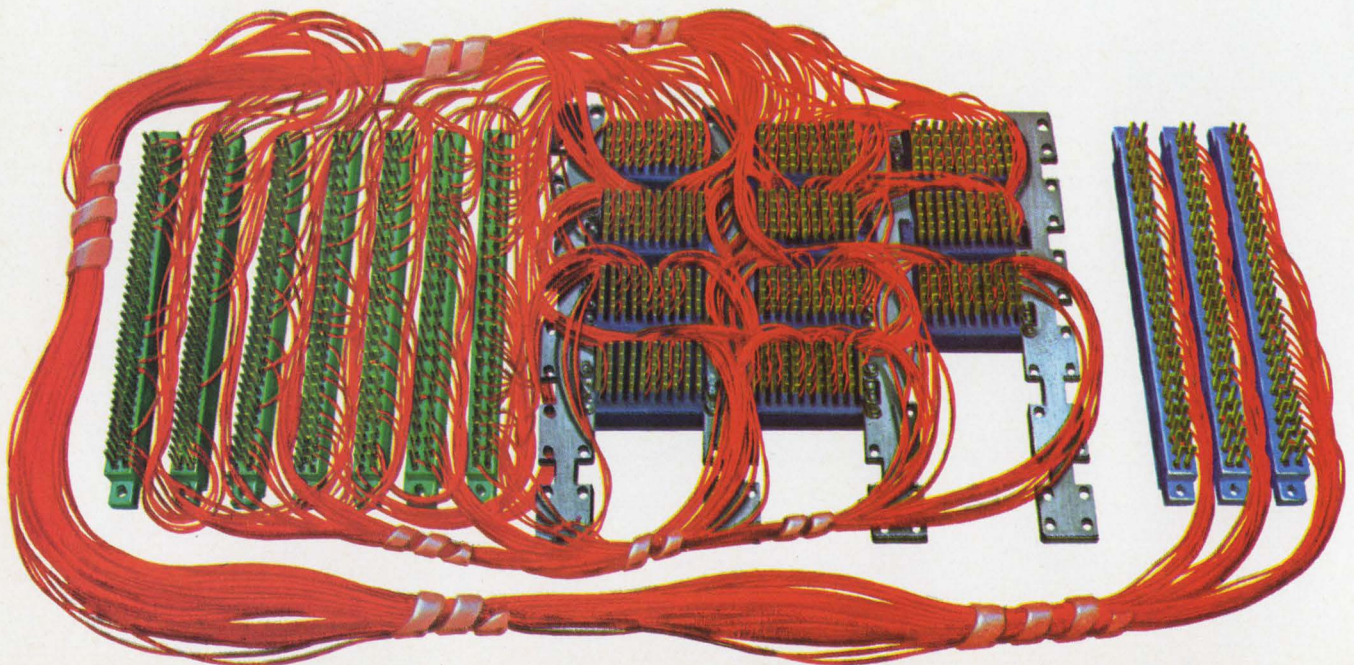

age plan for panels. ing wiring...in your

Printed Circuit Connectors. One piece or two piece. In a great variety of sizes that can all be wired automatically on TERMI-POINT or wrap-type posts.

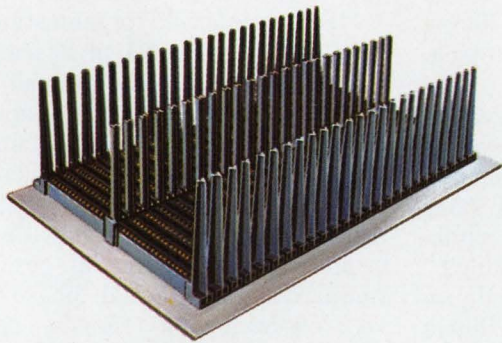

IC Packaging Panels. We can supply header components in a wide variety including Dip Headers, Miniature Spring Sockets, and various IC Sockets. All available with TERMI-POINT, wrap-type or solder posts.

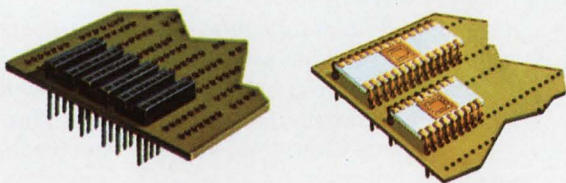

Input/Output Connectors. Both M Series and High Density Rectangular Connectors are available with rear posts for automatic wiring. They can be panel mounted and are obtainable in a host of position sizes. Both are furnished with TERMI-POINT or wrap-type posts.

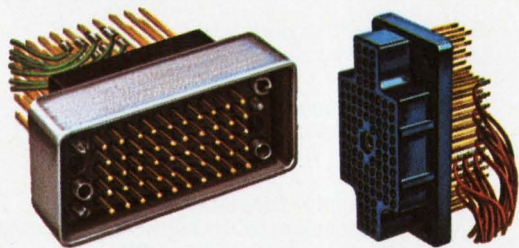

Your plant or ours. It doesn't really matter which. You can wire with our machines in your plant. Or let us do it for you in our plant. To your specifications, of course.



If you're interested in what else we can do with panels, write for more information to: **Industrial Division, AMP Incorporated, Harrisburg, Pa. 17105.**

★Trademark of AMP Incorporated

AMP
INCORPORATED

Circle 21 on reader service card

High Voltage Silicon Rectifiers

Available in production quantities now!

HIGH VOLTAGE RECTIFIERS*					
1000V	I _o	1-99	7000V	I _o	1-99
VA 10	50mA	1.36	VC 70	1.5A	6.82
VB 10	100mA	1.41	VF 5-7	5mA	1.71
			VF 10-7	10mA	1.89
			VF 25-7	25mA	2.08
1500V			8000V		
VA 15	50mA	1.44	VC 80	1A	7.15
VB 15	100mA	1.51			
2000V			10,000V		
VA 20	50mA	1.55	VF 5-10	5mA	1.96
VB 20	100mA	1.59	VF 10-10	10mA	2.16
VC 20	2A	5.20	VF 25-10	25mA	2.38
2500V			12,000V		
VA 25	50mA	1.66	VF 5-12	5mA	2.22
VB 25	100mA	1.72	VF 10-12	10mA	2.44
			VF 25-12	25mA	2.68
3000V			15,000V		
VA 30	25mA	1.93	VF 5-15	5mA	2.30
VB 30	50mA	1.88	VF 10-15	10mA	2.54
VC 30	2A	5.52	VF 25-15	25mA	2.80
3500V			20,000V		
VA 35	25mA	2.70	VF 5-20	5mA	2.97
			VF 10-20	10mA	3.27
			VF 25-20	25mA	3.60
4000V			25,000V		
VB 40	50mA	2.05	VF 5-25	5mA	3.72
VC 40	2A	5.85	VF 10-25	10mA	4.09
			VF 25-25	25mA	4.51
5000V			30,000V		
VB 50	50mA	2.40	VF 5-30	5mA	4.46
VC 50	1.5A	6.18	VF 10-30	10mA	4.91
VF 5-5	5mA	1.60	VF 25-30	25mA	5.39
VF 10-5	10A	1.77			
VF 25-5	25mA	1.95			
6000V			40,000V		
VB 60	50mA	2.62	VF 5-40	5mA	5.95
VC 60	1.5A	6.50	VF 10-40	10mA	6.54
			VF 25-40	25mA	7.20

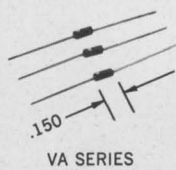

VA SERIES

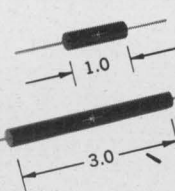

VF SERIES

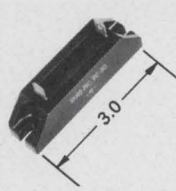

VC SERIES

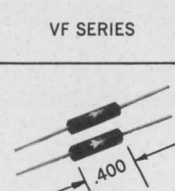

VB SERIES

*Available with fast recovery characteristic.



SEMICONDUCTOR DIVISION, 1000 N. SHILOH ROAD, GARLAND, TEXAS 75040 (214) 272-4551

Meetings

Filters on the boardwalk

Springtime in Atlantic City usually means a walk on the boardwalk, a visit to an auction, or being entertained on the Steel Pier. However, from April 27 to 29 electrical engineers and physicists will have something else to do while at this famous New Jersey resort. They will be able to attend the 24th annual Frequency Control Symposium sponsored by the U.S. Army Electronics Command. The symposium will be housed at the Shelburne Hotel and will consist of eight technical sessions.

"The basic idea of the symposium is to cover the latest developments in physics and engineering while also trying to discuss items of technical interest to the manufacturers of quartz-crystal filters," says G.K. Guttwein, technical-program director. And crystal filters will occupy the lion's share of the time with sessions on fundamental research and quartz-crystal research, filtering techniques and crystal filters, crystal design and engineering, and crystal measurements. Other sessions include an introductory one, oscillators and synthesizers, atomic- and molecular-frequency control, and time-keeping and distribution.

Twist. The highlight paper of the symposium is one of the 12 invited papers; it is by Raymond D. Mindlin of Columbia University and is titled "The Thickness Twist

of a Quartz Strip." Mindlin is an expert in the field of vibration in anisotropic bodies. Other invited papers include: review of digital filtering, generalized filters using surface ultrasonic waves, active filters, laser frequency-stabilization techniques, automatic frequency control and phase locking of lasers, surface waves and their development, and time-frequency technology in system development.

Many specialized organizations, such as NASA, the Naval Research Lab, and the National Bureau of Standards are presenting papers on various subjects. For instance, NASA papers include frequency comparison of the NASA experimental hydrogen maser with a mean of five commercial cesium standards, and diurnal phase of very-low-frequency signals near the antipodal of the transmitter; while NBS papers cover possibilities for future primary frequency standards. The Navy lab's papers are on a second satellite-oscillator experiment, and time and frequency transfer through the use of a microwave link.

The symposium includes papers from as far away as the University of Khartoum in the Sudan as well as contributed papers from Harvard, Columbia, and Georgia Tech.

For further information, contact V.J. Kublin, U.S. Army Electronics Command, Ft. Monmouth, N.J.

Calendar

Symposium on Submillimeter Waves, IEEE, Polytechnic Institute, Brooklyn, New York, **March 31-April 2, 1970.**

Communications Satellite Systems Conference, American Institute of Aeronautics and Astronautics; International Hotel, Los Angeles, **April 6-8, 1970.**

Joint Railroad Conference, IEEE; Sheraton Hotel, Philadelphia, **April 7-8.**

Reliability Physics Symposium, IEEE;

Stardust Hotel and Country Club, Las Vegas, Nevada, **April 7-9, 1970.**

Meeting and Technical Conference, Numerical Control Society; Statler Hilton, Boston, **April 8-10, 1970.**

Computer Graphics International Symposium, IEE; Uxbridge, Middlesex, England, **April 13-16, 1970.**

International Geoscience Electronics Symposium, IEEE; Mariott Twin Bridges

(Continued on p. 24)

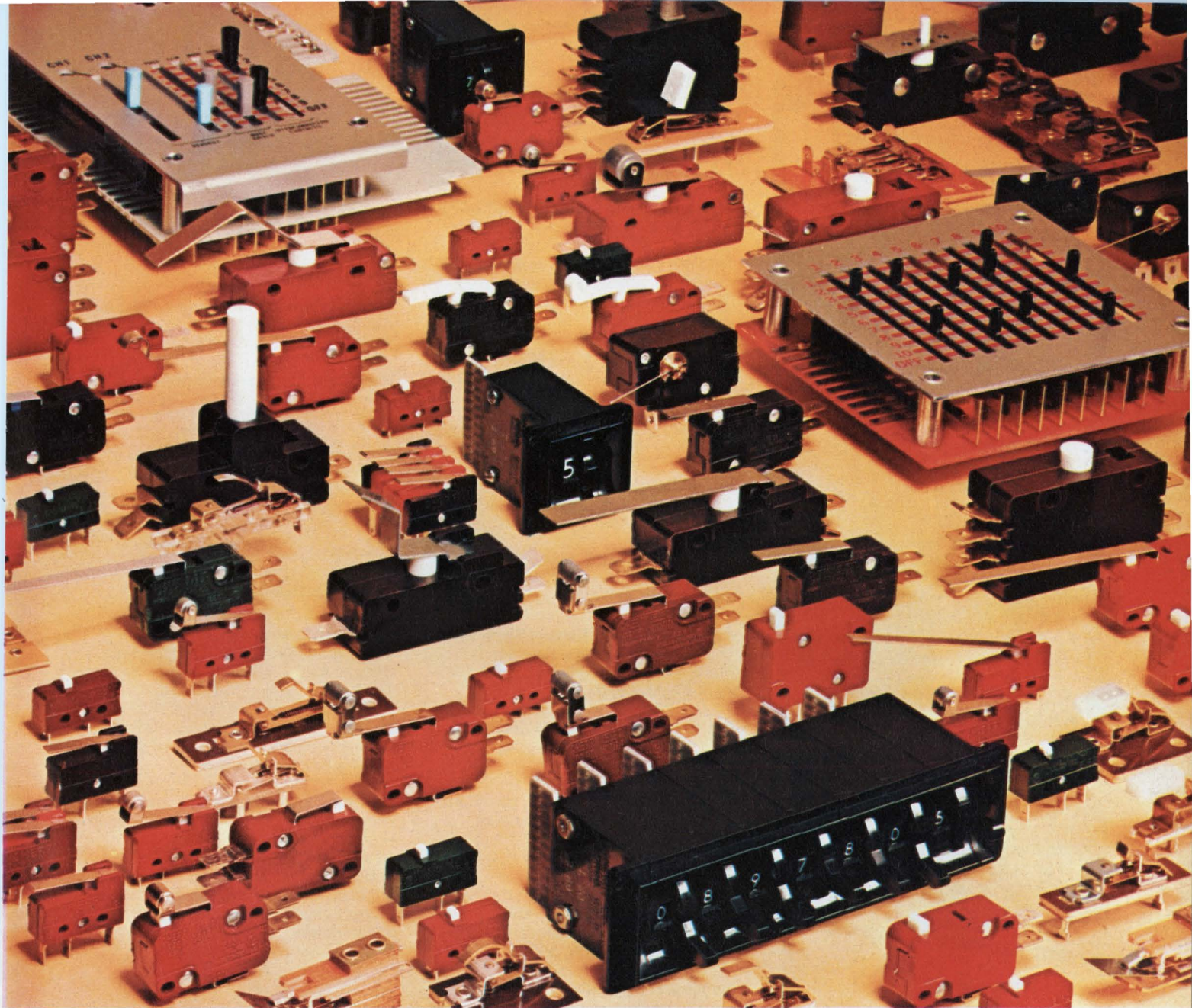

If 97,650 aren't enough ...we'll propose one just for you

Switching problem? Bring it to Cherry. We'll make the switch search FOR you. From among the nearly 100,000 different switches made possible by our highly specialized switch design and manufacturing facilities.

With so many switches from which to choose, there's sure to be one that's perfect for your application . . . and to solve your switching problems.

Whether it's a simple adaptation of something we've already produced or a standard catalog type switch available from stock, you'll get fast action from Cherry. And, if your application requires tooling, we'll propose an entirely new switch . . . just for you.

SEND FOR OUR NEW 44-PAGE FULL LINE CATALOG. It contains complete design information on Cherry long life precision switches.

CHERRY

CHERRY ELECTRICAL PRODUCTS CORP.
1650 Old Deerfield Road, Highland Park, Illinois 60035

Makers of patented Snap-Action, Leverwheel/Thumbwheel and Matrix Selector Switches.

Circle 23 on reader service card

TRYGON lab power supplies are...

Full Range
Bench and Rack
Precision
Power Supplies
to 320 VDC,
up to 150A.

**FOR
IMMEDIATE
DELIVERY**

- Auxiliary features important to varied application
- Single, dual and triple outputs
- Field proven high quality and reliability

Write today for your copy of Trygon's
1970 Power Supply Handbook

 **TRYGON POWER SUPPLIES**

111 Pleasant Avenue, Roosevelt, New York 11575
Tel: 516-378-2800 TWX: 510-225-3664
Trygon GmbH 8 Munchen 60, Haidelweg 20, Germany

Meetings

(Continued from p. 22)

Motor Hotel, Washington, April 14-17, 1970.

Semiconductor Packaging in the 1970's, Polytechnic Institute of Brooklyn; Park Sheraton Hotel, New York, April 16-17.

USNC/URSI-IEEE Spring Meeting; Statler Hilton Hotel, Washington, April 16-19.

American Power Conference, IEEE; Sherman House, Chicago, April 21-23, 1970.

International Magnetics Conference (Intermag), IEEE; Statler Hilton Hotel, Washington, April 21-24, 1970.

Southwestern IEEE Conference & Exhibition; Memorial Auditorium, Dallas, April 22-24.

Annual Frequency Control Symposium, U.S. Army Electronics Command; Shelburne Hotel, Atlantic City, N.J., April 27-29, 1970.

National Telemetry Conference, IEEE; Statler Hilton Hotel, Los Angeles, April 27-30, 1970.

National Relay Conference, Oklahoma State University and the National Association of Relay Manufacturers; Oklahoma State University, Stillwater, April 28-29, 1970.

Transducer Conference, IEEE; National Bureau of Standards, Washington, May 4-6, 1970.

Aerospace Power Conditioning Specialists Conference, IEEE; Royal Pines Motel, NASA, Greenbelt, Md., April 20-21. Industrial and Commercial Power Systems and Electric Space Heating & Air Conditioning Joint Technical Conference, IEEE; Jack Tar Hotel, San Francisco, May 4-7.

Safety in Research and Development, National Safety Council and the American Society of Safety Engineers; Cambridge, Mass., May 4-5.

National Appliance Technical Conference, IEEE; Leland Motor Hotel, Mansfield, Ohio, May 5-6, 1970.

Spring Joint Computer Conference, IEEE; Convention Hall, Atlantic City, N.J., May 5-7.

Midwest Symposium on Circuit Theory, IEEE and the University of Minnesota; University of Minnesota, Minneapolis, May 7-8.

International Microwave Symposium, IEEE; Newporter Inn, Newport Beach, Calif., May 11-14.

Annual Technical Conference and Exhibit, American Society for Quality Control; Pittsburgh Hilton Hotel, May 11-13.

Southeastern Textile Industry Technical Conference, IEEE; Marriott Motor Hotel, Atlanta, Georgia, May 14-15.

Aerospace Electronics Conference, (Naecon) IEEE; Sheraton Dayton Hotel, Ohio, May 18-20.

Conference on Signal Processing Methods for Radio Telephony, IEE; London, May 19-21.

Short courses

Data Structures, Association for Computing Machinery; Marriott Twin Bridges Motor Hotel, Arlington, Va., April 14; Holiday Inn, New York, April 15; Howard Johnson's Chatham Center, Pittsburgh, April 16; Pick Congress Hotel, Chicago, April 17; \$90 fee for nonmembers.

Managing Systems Analysis and Design, Association for Computing Machinery; Hilton Inn, Kansas City, Mo., April 16-17; Jack Tar Hotel, San Francisco, April 30-May 1; Airport Marina, Los Angeles, May 4-5; Pick Congress Hotel, Chicago, May 21-22; \$165 fee for nonmembers.

Call for papers

Symposium on Reliability, IEEE, American Society for Quality Control; Sheraton Park Hotel, Washington, Jan. 12-14, 1971. May 1 is deadline for submission of paper titles and abstracts to J.W. Thomas, Program Chairman, Annual Symposium on Reliability, Vitro Laboratories, 14000 Georgia Ave., Silver Spring, Md. 20910.

Symposium on Man-Machine systems, IEEE; Langford Hotel, Winter Park, Fla., Nov. 12-13. May 15 is deadline for submission of summaries to S.E. Michaels, Bell Telephone Laboratories, Room 3D-529, Holmdel, N.J. 07733.

Conference on Electron Device Techniques, IEEE; United Engineering Center Auditorium, New York, Sept. 23-24. May 15 is deadline for submission of abstracts to Hayden Gallagher, Hughes Research Laboratories, 3011 Malibu Canyon Rd., Malibu, Calif. 90265.

TI's quiet
revolution in
value



Plastic DTL does cost less. Add it up.

So it's only 6 or 7 cents per circuit. Who wants to pay for more than he needs—especially when production runs can multiply those cents into big money.

If you're paying more for dual-in-line packaging (plastic or ceramic)...if you need Series 15830 DTL ICs and need 'em fast...call TI or your authorized TI Distributor.

We're delivering more than 100,000 plastic devices a day—and

maintaining more than 1,000,000 pieces in inventory as a further assurance of fast delivery on our wide choice of functions.

Our plastic package has also proven its reliability. We've ac-

TI delivers 33 DTL devices, including the tough ones:

- ✓ all dual flip-flops
- ✓ all single flip-flops
- ✓ one-shot
- ✓ all power/buffer gates

cumulated 80,000,000 device hours of reliability test data during the four years TI has manufactured the DTL SN15830N series.

If you want to do some further figuring on plastic DTL, get our slide-rule data sheet. Write Texas Instruments Incorporated, P.O. Box 5012, M.S. 308, Dallas, Texas 75222. That's where the quiet revolution is going on. Or call your authorized TI Distributor.



TEXAS INSTRUMENTS
INCORPORATED

In less than one second

you've got it

Permanent gas-tight
electrical connections
with Gardner-Denver
Wire-Wrap* tools

These light, quiet air tools wrap wires at a high rate of speed for solderless connections that are permanent, gas-tight, and reliable. Model 14XL1 weighs 13½ ounces, takes bits and sleeves for 20 through 32 gauge wire.

Pneumatic Wire-Wrap tools have pistol grip or straight handles. Or you may prefer our electric-powered models. Or the model with rechargeable battery. Manual wrapping and unwrapping tools are available for service kits. Bulletin 14-1 describes them all. Write for your copy today.

GARDNER-DENVER

Gardner-Denver Company, Quincy, Illinois 62301

*Registered Trademark

Circle 26 on reader service card



wired

A hand is shown holding a wire-wrap tool against a complex wiring harness. The tool is a Gardner-Denver wire-wrap tool, and the harness is a dense network of wires connected to a metal frame. The background is a plain white surface.

See these
Gardner-Denver
Wire-Wrap Tools
at NEPCON CENTRAL
BOOTH 703
Sherman House,
Chicago
April 7, 8 & 9

Custom(er) Cable Constructions by Chester

Proof of Chester's ability to produce plastic coated multi-conductor cable construction to customer requirements is reflected in part by the production samples shown on these pages. Though only representative of the thousands of "specials" made for our many customers they graphically prove Chester's ability to translate a wide range of special multi-conductor needs into dependable and practical cable constructions.

When standard cable constructions will not suffice, Chester's vast resources, technical skills and manufacturing facilities are placed at your disposal to manufacture conductors, insulations and jackets to meet your most exacting requirements.

Whatever your multi-conductor cable needs, check first with Chester. We know you'll be more than pleased with the expeditious and thorough handling of your request.

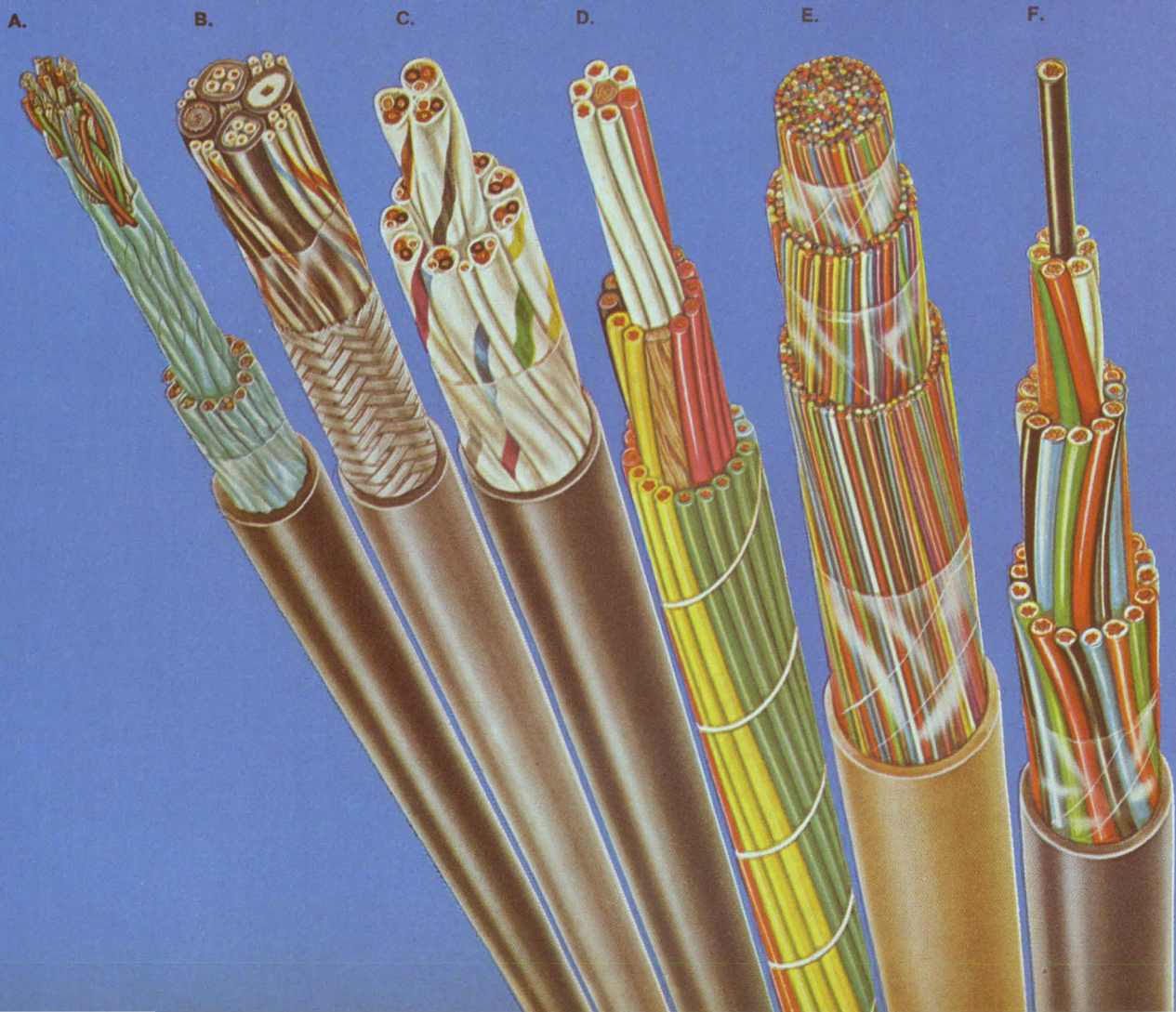

- A. RECORDING STUDIO:** Audio sound cable: 25 shielded pairs, stranded copper conductors, low loss insulation, twisted with uninsulated drain wire, isolated aluminum tape shields, cabled, PVC jacket.
- B. TV CAMERA MFR.:** Camera control cable for Audio and Video signals: a composite of PVC and polyethylene insulated conductors, cabled, overall braid shield, PVC jacket.
- C. AIRCRAFT SIMULATOR MFR.:** Control cable: 12 triples shielded jacketed, stranded copper conductors, PVC insulated, individual shield jacket color coded, cabled overall PVC jacket.
- D. ELEVATOR MFR.:** Control cable: 35 conductors, stranded copper, PVC insulated, conductors coded by colors and printed numbers, cabled with open binder; individual conductors U/L listed.
- E. INTERCOM EQUIPMENT MFR.:** 250 conductor inter-office communication and signaling cable: solid bare copper, PVC insulation, paired, cabled, PVC jacket; U/L listed.
- F. ELECTRIC UTILITY CO.:** Station control cable for general use: 37 conductors, stranded, polyethylene and PVC insulated, color coded, cabled, overall tough PVC jacket; per NEMA/IPCEA Specifications.
- G. LARGE CITY:** Communication cable: 50 pairs, polyethylene insulated, cabled, continuous layer of copper shielding tape, PVC jacket; per spec. IMSA-19-2, 600 volts.
- H. LEADING SHIPBUILDER:** shipboard cable: stranded conductors, nylon-jacketed PVC insulation, pairs shielded and jacketed, cabled, PVC jacket, and aluminum braid armor overall; per spec. MIL-C-915.
- I. U. S. GOVERNMENT:** Coaxial cable: type RG-218/U, solid copper conductor, polyethylene insulated, copper braid shield, PVC jacket; per spec. MIL-C-17/79.
- J. BROADCASTING COMPANY:** Remote control broadcasting cable: stranded conductors, polyethylene insulation, pairs & triples shielded and jacketed, cabled, PVC jacket overall.
- K. COMPUTER MFR.:** Computer control cable: 55 conductors, stranded copper conductors, PVC insulated, formed into 7 groups of 7 conductors, cabled, PVC jacket; U/L listed.
- L. MACHINERY MFR.:** Bus drop cable: 3 PVC insulated stranded conductors, with split uninsulated grounding conductor, cabled, overall PVC jacket; U/L listed; per NEC.



CHESTER CABLE
 OPERATIONS
 CITIES SERVICE COMPANY
 CHESTER, NEW YORK • 10918

PHONE (914) 469-2141 TWX (914) 469-9601

Circle 29 on reader service card

It's a great week to order

M



Metal-clad circuit materials

We supply metal-clad laminates in flexible, rigid board, and ultra-thin. Our lineup includes the widest selection of flexible materials, including Kapton and Mylar types. We offer highest quality glass-epoxy laminates of all grades, to military, NEMA, and IPC specs.

T

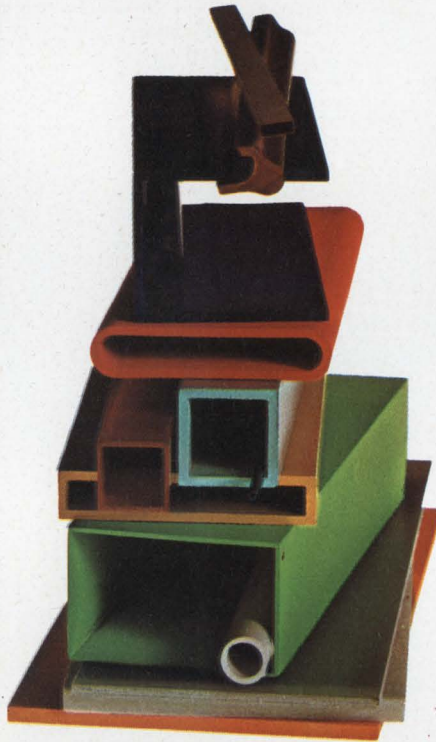

Laminated plastics

We manufacture laminated sheets, rods, and tubes in an unmatched variety of materials, dimensions, and shapes to suit the most exacting requirements. In sheets, for example, we offer more than 50 base grades with reinforcements of paper, glass, fabric, asbestos, and other materials.

W



Molded plastic parts

Molding thermosetting plastic parts calls for experience and equipment—and we have both. We offer molding capability that produces parts of unusual shapes that require little or no finishing, and with strength comparable to laminated plastics. Our know-how results in economical molded parts.

our materials and parts.



Fabricated plastic parts

Specialized equipment, experience, rigid quality control, and application engineering are four big advantages of Synthane-Taylor plastics fabrication. We can handle every step, from raw materials selection to tooling and production. We produce any size, in any quantity.



Vulcanized fibre

We furnish vulcanized fibre in sheets, rolls, coils—and fabricate it, too. It has excellent electrical and mechanical properties: resistance to arcing, flame, abrasion, impact, wear, chemicals. It is strong, flexible, formable.

Synthane-Taylor has the capability to meet your every need every day of the week. There are three plants, local warehouses, and a nationwide staff of sales engineers to serve you.

Today's the day to find out more. Send the coupon for full information.

Synthane-Taylor Corporation
Valley Forge, Penna. 19481

Please send _____ information
and/or _____ samples on:

- Metal-clad circuit materials
- Laminated plastics
- Molded plastic parts
- Fabricated plastic parts
- Vulcanized fibre
- Have a sales engineer contact me

My application is _____

Name _____

Title _____

Firm _____

Street _____

City _____ State _____ Zip _____



synthane·taylor

Circle 31 on reader service card

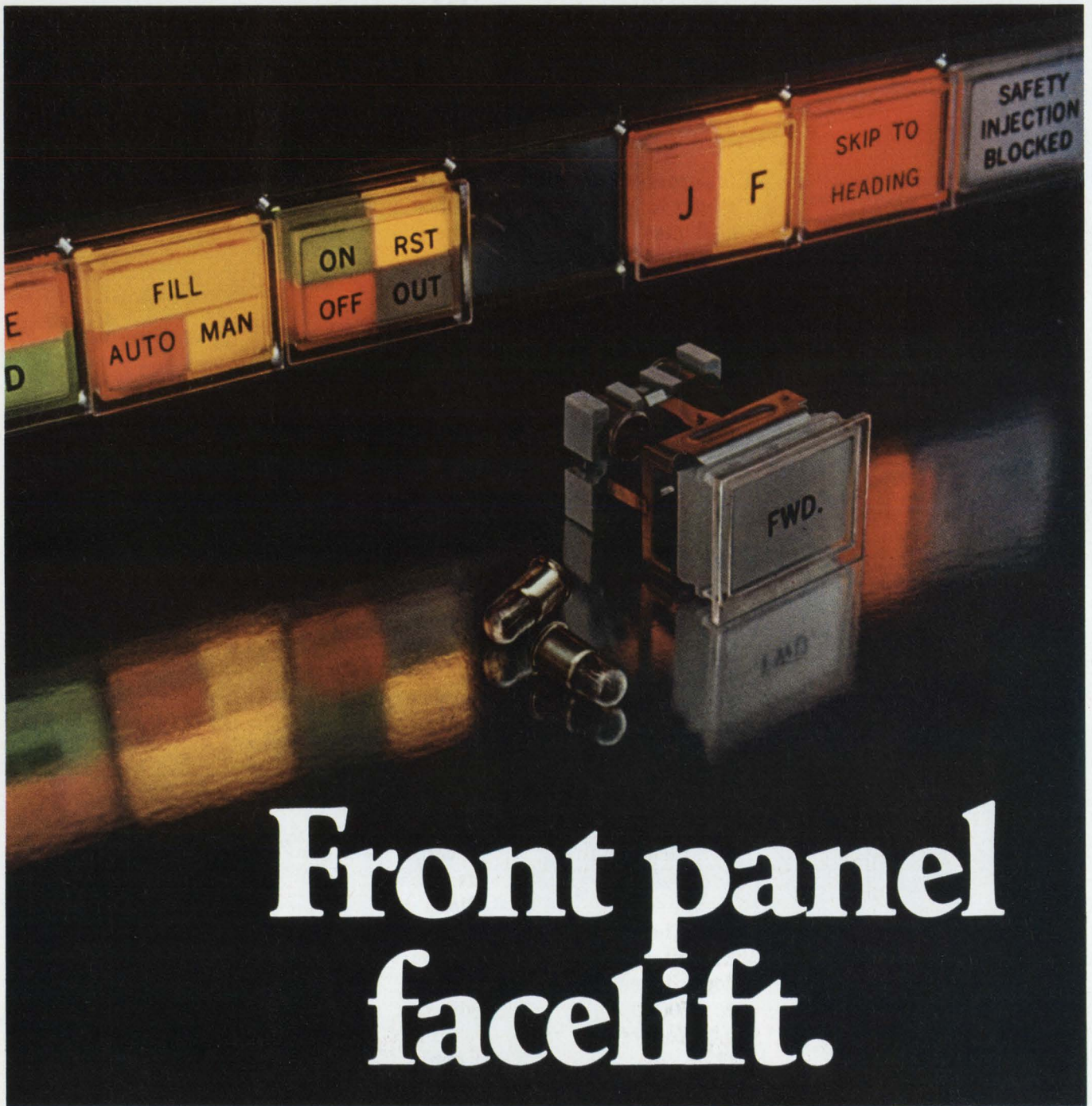

Front panel facelift.

When one of our 2W lighted pushbuttons needs a change of color filters, legends, or lamps—the change is simple. Because the switch stays mounted in the panel. Just one straight, gentle pull and the change is ready to be made.

The rugged design and proven switch performance are especially suited for military/aerospace applications. And our 2W

meets the requirements of MIL-S-22885.

The 2W is available with a wide variety of display screens, color filters and switch modules.

For more information call your MICRO SWITCH Branch Office or Authorized Distributor, or write for Product Sheet 2W.

MICRO SWITCH

FREEPORT, ILLINOIS 61032
A DIVISION OF HONEYWELL

HONEYWELL INTERNATIONAL: Sales and service offices in all principal cities of the world.

Electronics Newsletter

March 30, 1970

Computer promises System 3-like job at half price

By incorporating some unusual design features in the processor and read-only memory, Hetra, a Melbourne, Fla., computer maker, has built a small machine that equals the performance of IBM's System 3 but sells for half the price. What's more, in larger configurations, the new machine can do the jobs of larger computers at a System 3 price.

The basic processor, called the S/I, has three features that help achieve this price/performance level: a very fast internal clock, running at 15 megahertz, that pushes the TTL just about to its limit; a 50-nano-second scratchpad memory of 64 bytes that's expandable to 256 bytes; and a push-pull instruction for processing characters in a last-in, first-out stack, which helps optimize the read-only memory design. The read-only memory itself, in addition to storing the usual control information, contains a low-level Cobol-like compiler that permits the machine to operate directly with rather sophisticated instructions.

These design features, in a processor that's relatively simple, achieve a substantial throughput even in layouts that include only a card reader, a printer, and perhaps a paper-tape machine. Hetra's larger systems, the S/II and S/III, use magnetic tapes and disks. But they aren't just beefed-up S/I's; rather, they're comprised of up to four interconnected S/I's. The extra ones have a different read-only memory that tailors them to the peripheral processing application.

Hughes implants silicon diode at room temperature

Hughes Aircraft, probably the leading advocate of ion-implantation in semiconductor devices, has produced silicon-carbide diodes with good electrical characteristics at up to 400°C for implanting nitrogen or antimony ion in material. Silicon carbide is considered an ideal semiconductor material because of its chemical stability, hardness, and high-temperature characteristics. Silicon devices work best at, or a little above, 125°C. The previous difficulty with silicon carbide, aside from the scarcity of good material, has been the very high temperature needed to dope it—long periods at 1,650°C in doping by epitaxial growth, or up to 2,500°C with other growth and diffusion processes.

The Hughes Research Laboratory's implantation, done at room temperature, requires substantial annealing to heal the damage associated with implantation but only for short periods and at maximum temperatures of 1,400°C to 1,600°C.

However, George Smith, vice president and director of the laboratories, cautions that while the work holds promise for high-temperature semiconductor devices and even though silicon carbide might make a good physical light emitter, the shortage of the material remains a problem.

H-P to sell 15-Ghz transistors

The high-frequency transistor race continues to pick up speed. The latest entry: Hewlett-Packard, which soon will start commercial sales of transistors with a maximum oscillation frequency of 15 gigahertz. The devices, now being used in the firm's own instruments, deliver 50 milliwatts and 4.5 decibels of gain at 8 GHz at a bias of 400 mw. The state of the art is under 10 GHz.

To obtain this performance, H-P uses extremely shallow diffusion. Because of this and a greatly simplified proprietary fabrication process,

Electronics Newsletter

H-P says it is getting extremely high yields—on the order of 80% to 90%.

Price to the outside customer for the unpackaged chip is expected to be about \$15; under \$50 for packaged units.

Debut pushed up for CBS color EVR

Racing RCA to dominate the American television-playback market, CBS has pushed up the delivery date of its color EVR system by a year—to the fall of 1970. What's more, EVR (electronic video recording) will sell for \$795 in its new compatible color version.

EVR is a photographic system in which a flying-spot scanner built into a tv attachment converts images on specially prepared film into a video signal [*Electronics*, June 9, 1969, p. 139]. Meanwhile, RCA, which is putting its money on the holography-based VPS (video playback system), is sticking with its promise to deliver in 1972 a \$400 color system with tapes costing \$10 each [*Electronics*, Oct. 13, 1969, p. 43]. VPS will have an optical sound track—magnetic and phonographic techniques have been rejected—and RCA scientists are still looking for a photoresist suitable for mass-producing video playback system master tapes.

Navy studies two-frequency modular transmitter

Lockheed Electronics is readying a transmitter module that transmits at two frequencies as a possible forerunner to the multiple-frequency phased-array systems under investigation by the Navy. Such single, multi-purpose arrays would eliminate the need for the many separate antennas for radar and communications now on Navy ships.

Outputs of the Plainfield, N.J., firm's module are 25 watts peak at 1.25 gigahertz (L band) and 8 watts at 3.75 Ghz (S band). The input signal—250 milliwatts at L band—is first amplified, then frequency multiplied to S band.

Elements in the module are built separately on alumina substrates using microstrip techniques, chip components, and deposited chrome-gold interconnections. The circuit elements then are bolted down in an x frame and interconnected to form the 6.5-by-5-inch module.

Lockheed, which began work on the dual-frequency transmitter with its own funds, is being sponsored by the Naval Research Laboratory as part of the Ships Integrated Electronic Systems (SIES) project.

Design contract due in May for Congress computer

The design contract for the Congressional computer system [*Electronics*, Dec. 8, 1969, p. 41] will be awarded in May, says Rep. Joseph D. Waggoner (D., La.), chairman of a House subcommittee responsible for the project. Eventually the system is expected to cost as much as a major weapons system—billions of dollars over the next 10 to 15 years.

The design contract will go to one of some 35 competing software companies; hardware manufacturers will not become involved until system design is complete, in an expected year to 18 months.

N.Y. pushed out of Picturephone

Picturephone service, to have started this July in New York and Pittsburgh, will be launched only in the Steel City. The reason: the phone company is busy trying to straighten out New York's conventional service. New York now is scheduled to get its video phones no earlier than 1971 [*Electronics*, Jan. 19, p. 131].

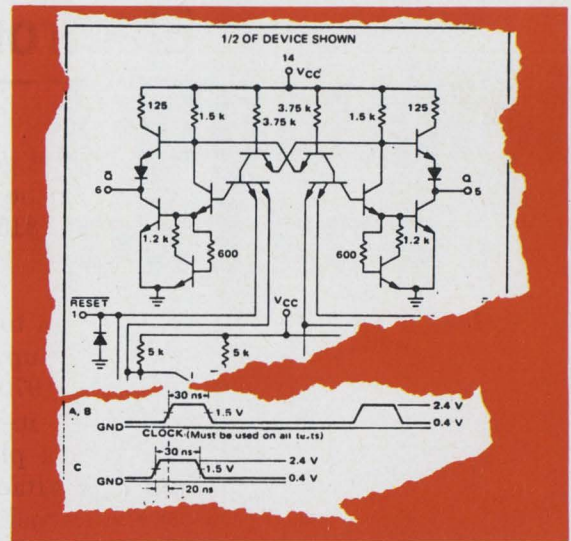
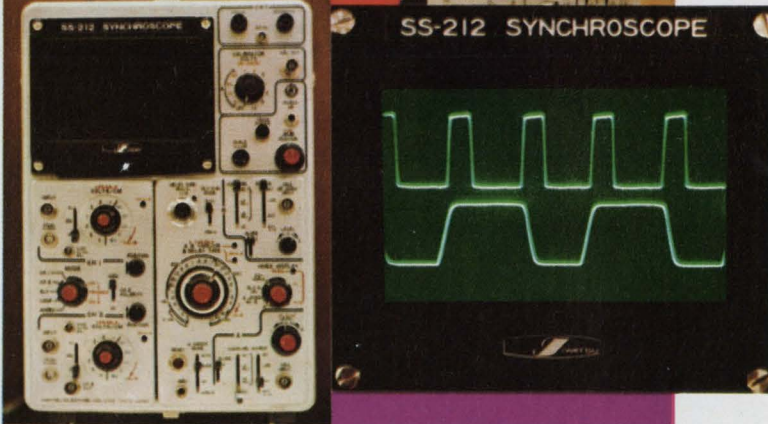
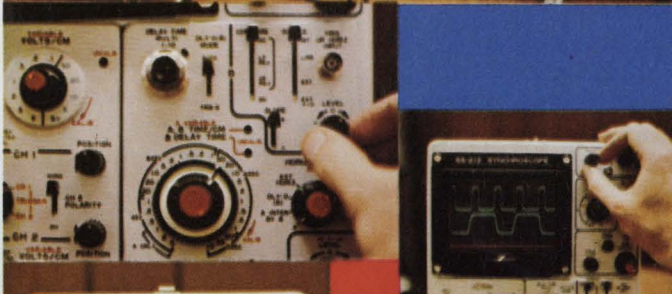
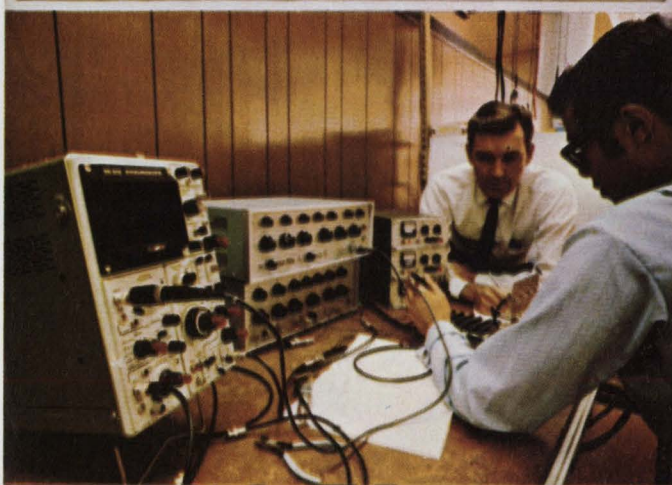
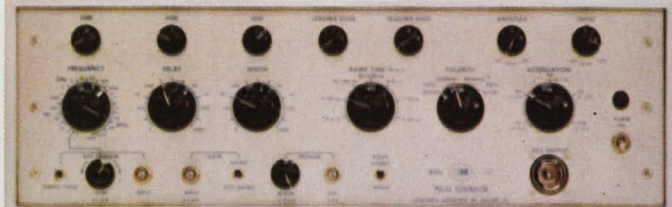

E-H the logical solution

The E-H Research Laboratories, Inc., America's leading designer and manufacturer of pulse generators and other measurement instruments, has teamed up with the Iwatsu Electric Company, Ltd., Japan's foremost manufacturer of oscilloscopes. Together they make an ideal team to solve any of your logic problems.

For example, the **E-H 137 pulser** is an ideal stimulus source offering a source impedance of 50 ohms, fast, ultra-clean, adjustable leading and trailing edge ramps, all the output levels you need for TTL and ECL logic and 100 MHz pulse repetition frequency.

Team this up with the **Iwatsu 212 oscilloscope** and you've got a team that'll perform to your utmost satisfaction for years to come. The Iwatsu 212 is the ideal wide-bandwidth scope featuring bandwidth in excess of 200 MHz, with sweep speeds and writing rate to match. One $M\Omega$ input impedance matches directly with the impedance level of circuitry under test. This is the only 200 MHz bandwidth oscilloscope featuring 1ns/cm and delayed sweep in one instrument. Big, bright 6x10 cm display is another feature.

These are only two instruments from a broad line of E-H and Iwatsu instrumentation exclusively available from E-H. So whatever your logic problems are, contact an E-H representative today for the most logical solution.



E-H RESEARCH LABORATORIES, INC.

515 Eleventh Street • Box 1289, Oakland, California 94604 • Phone: (415) 834-3030 • TWX 910-366-7258

In Europe: E-H Research Laboratories (Ned) N.V., Box 1018, Eindhoven, The Netherlands, Telex 51116

In Japan: Iwatsu Electric Company, Ltd., 7-41, 1-Chome Kugayama Sugiyama-Ku, Tokyo 167, Japan

**Reliability is a spring, a wheel
and two thingamajigs.**

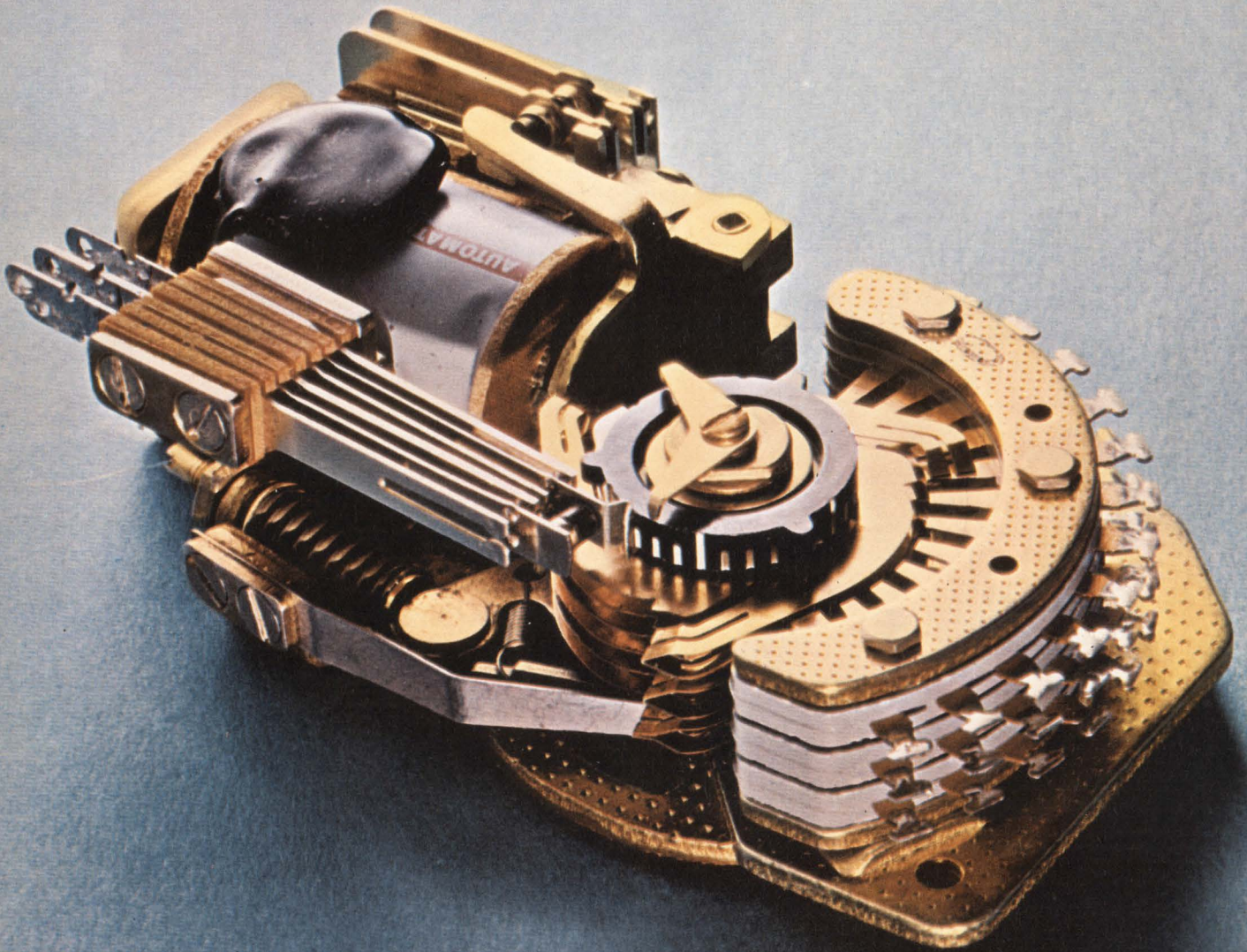



Every AE Type 44 stepping switch comes with them.

One-spring power.

The drive spring is a coil. What it does is store up power. When it comes time to switch, the spring lets loose and moves the wiper assembly forward. Each time using precisely the same pressure.

Notice our spring is tapered at one end. It's designed to perfectly match the power input. That's why you always get the best possible transfer of energy.

At one end of the drive spring is an adjusting screw. We turn it a little this way or a little that way and the tension is always perfect.

Try that with a flat spring.

We re-invented the wheel.

The ratchet wheel is a little different. The way it's made, for one thing. First, we blank it. Next, shave it. And finally, case-harden it. Then it's super strong.

Notice the big, square teeth that always provide a sure bite.

A thingamajig with teeth.

That thingamajig next to the wheel is the armature assembly. When the teeth on the end of it mesh with the teeth on the ratchet wheel, they stop the wiper assembly and position it precisely on the contact bank. Smooth as silk, every time. No jarring, no jamming, no banging.

No adjustments, either. As the teeth wear, they just drop further into the wheel. So nothing ever gets out of whack.

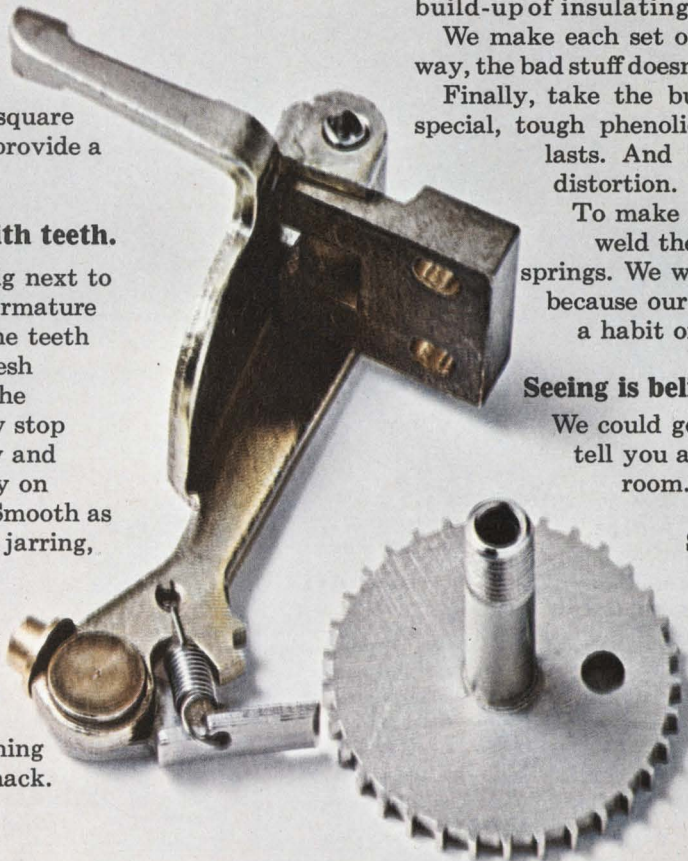

A pawl that floats.

On the end of the armature is the pawl. We made it "free floating" to eliminate the jamming and binding that go with the old style pawl stop block. And while we were at it, we stopped pawl breakage and put an end to double-stepping or overthrow.

Don't bother looking for this special set-up anywhere else. It's patented.

The other thingamajig.

It's called a contact spring. We've got some strong feelings as to what makes a contact spring strong.



In the first place, we believe there's strength in numbers. So we put two sets of contacts on each spring. This means you get a completed circuit every time. Without fail.

But some of the credit for this has to go to our solving the most common cause of contact failure—the build-up of insulating films on the contact points.

We make each set of points self-cleaning. That way, the bad stuff doesn't have a chance to build up.

Finally, take the buffers. We make ours of a special, tough phenolic material that lasts. And lasts. And lasts. All without wear or distortion.

To make sure they stay in place, we weld the buffer cups to the contact springs. We weld, rather than use rivets, because our lab found that rivets have a habit of falling off or wearing out.

Seeing is believing.

We could go on talking reliability and tell you about our testing and run-in room. There's a lot more to tell.

But we'd rather have our Sales Representative show you. And let you see first hand the reliability that's built into every AE stepping switch.

Just call or write. Automatic Electric Company, Northlake, Illinois 60164.

AUTOMATIC ELECTRIC
SUBSIDIARY OF GENERAL TELEPHONE & ELECTRONICS

Introducing The Electronics Network.

Channel 1:

Sells the decision-making market.

Electronics is the worldwide electronics marketing channel. Use it to build a market position for your products. To create acceptance for your advanced technology. Or simply to sell ideas.

Many of Electronics 81,000 subscribers cannot be reached through any other publication. Sixty-seven per cent buy anywhere from \$10,000 to over \$1,000,000 worth of products each year. And many of them never see salesmen.

40 skilled editors located in the key market areas and an annual editorial budget in excess of \$1,000,000 provide Electronics readers with broadband technical information to help them do their jobs better.

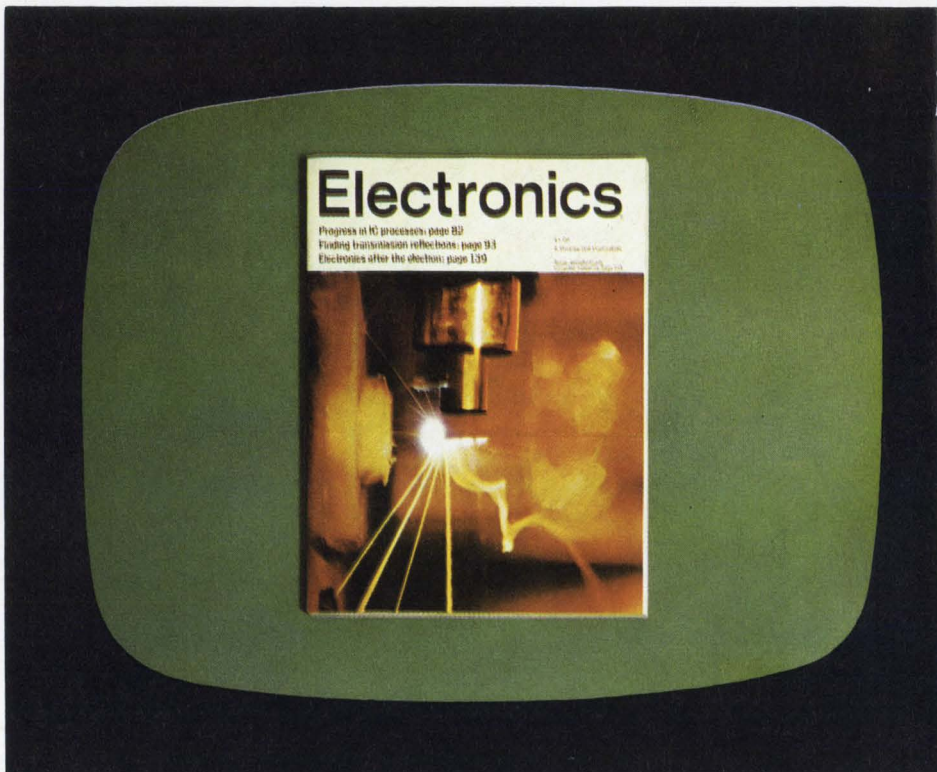

Channel 2:

Covers the mass market.

Electronics New Product Preview is the low-cost, mass-coverage channel to the U.S. market (where approximately 70% of the worldwide market is located). Use it as cooperative direct mail to merchandise off-the-shelf products, promote established low profit-margin items. Or use it to generate quick inquiries for your catalogs and specification sheets. (Our first issue produced over 50,000 inquiries.)

ENPP reaches 100,000 U.S. recipients (without duplicating the circulation of Electronics). It publishes more new-product information than any other electronics publication and presents it in ten product sections.



Four channels
designed to work together
to make your
advertising budget
go farther.

**Channel 3:
Reaches the ready-to-buy market.**

Electronics Buyers' Guide is the channel to use for reaching customers who are actively seeking sources of supply. EBG goes to 85,000 engineers and purchasing men, but is used by more than 375,000 of them. (It's borrowed a lot.) The "yellow pages" gives the buyers all the information they need in one reference: sources, product and advertisements. Prime users tell us they prefer EBG two to one over all other directories, catalogs and registers because it is so complete and easy to use.

**Channel 4:
Provides custom marketing services.**

Electronics/Management Center can develop a customized information program to help you reach your markets. It can probe market potentials, test new product ideas, improve old products, even design a complete marketing strategy.

Electronics/Management Center has the people and facilities to provide you with custom-information in the areas of management, marketing and engineering consultation.

Write for the E/MC brochure, "A full-circle information resource."

*The Electronics Network.
A market-directed communications
service from McGraw-Hill.
Electronics. Electronics New Product Preview.
Electronics Buyers' Guide.
Electronics/Management Center.
330 West 42nd Street, New York, N. Y. 10036.*

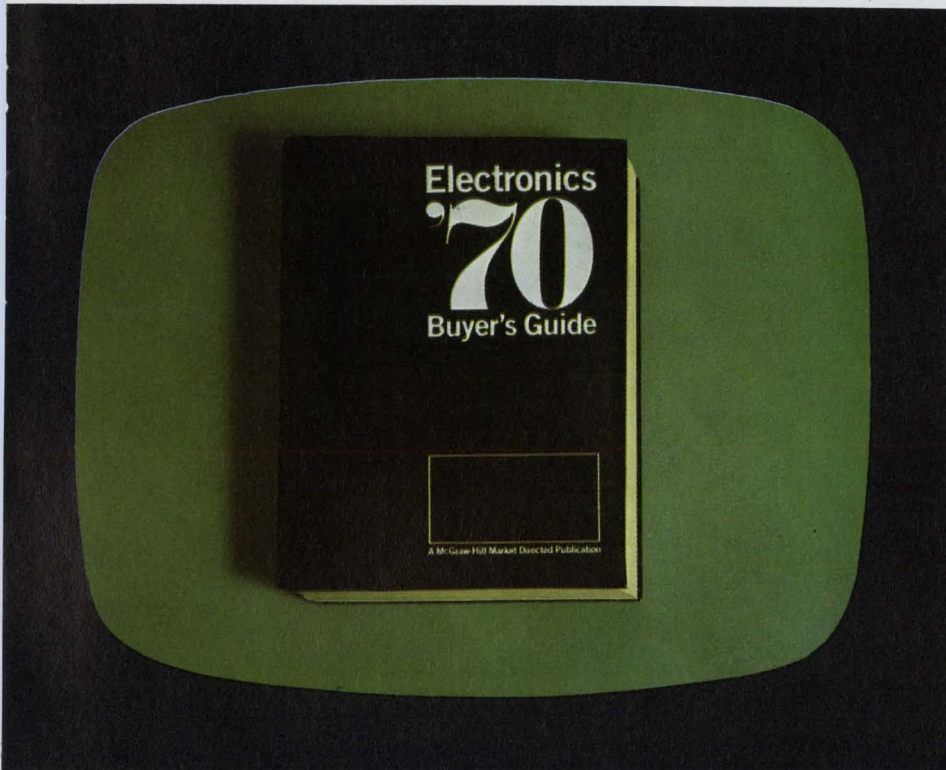

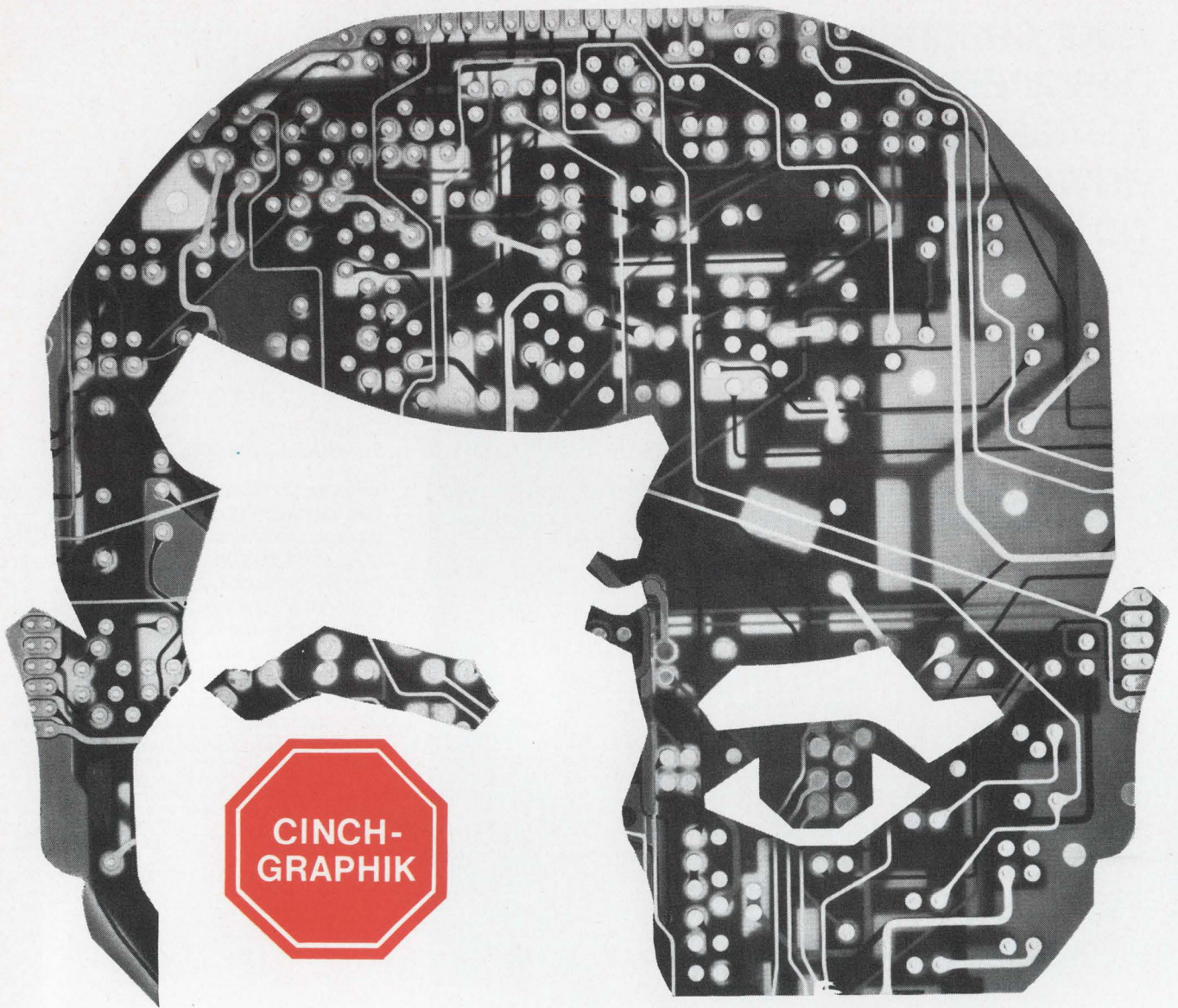

your multilayer man for volume production

Twenty million boards a year make Cinch-Graphik the world's largest independent producer of printed circuits. The industry's most advanced equipment, including an exclusive, 6-ton, 28 foot multilayer camera is housed in a 125,000 square foot plant that has capacity for additional volume production.

For information on how Cinch-Graphik can produce precision boards in volume, for you, contact your Cinch—Sales District Office or Cinch-Graphik, 200 South Turnbull Canyon Road, City of Industry, California 91744, Telephone, (213) 333-1201.

CINCH-GRAPHIK
DIVISION OF UNITED-CARR

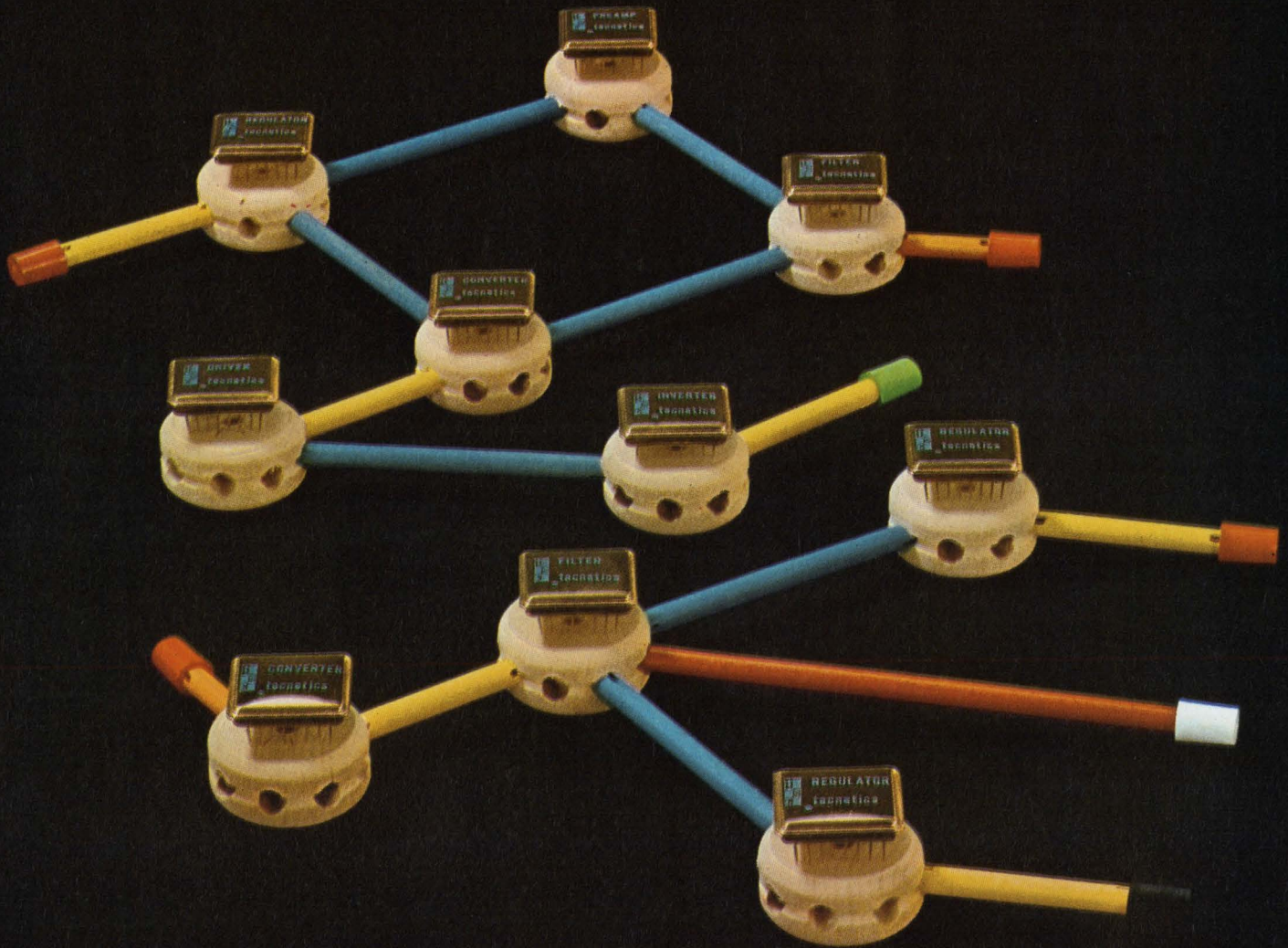

Now...save power supply design time with this advanced concept from Tecnetics

And get the added advantages of reduced size, increased reliability!

The Tecnetics team is now designing and manufacturing repeatedly-used power conditioning circuits into convenient plug-in, MIL-qualified, cold-weld, hermetically-sealed, miniature packages... to help facilitate your design and save time.

TEC is making available its combined experience in the power conditioning and hybrid microelectronics technologies by introducing a series of time-saving, point-of-load standard modules in today's dual-in-line packaging configuration. These concepts can also be used to accommodate your specific design requirements.

TEC has been designing and manufacturing power supplies for critical aerospace, military and industrial systems for more than a decade.

For more information on these new power conditioning concepts, tec-notes, prices or delivery information, call (collect) 303-442-3837; write Tecnetics, Inc. (formerly Transformer-Electronics Co.), P. O. Box 910, Boulder, Colorado 80302; or TWX 910-940-3246.

tecnetics inc.

The innovator in power conditioning

Introducing the first bipolar compatible MOS ROM.

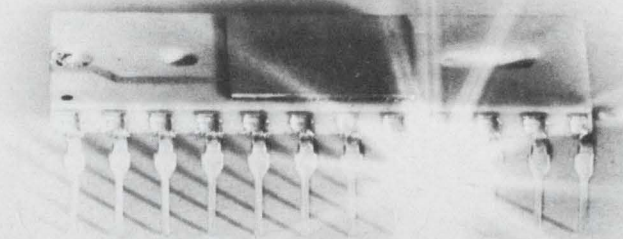

No ifs, ands or external resistors.

A lot of people have said their MOS ROM's were bipolar compatible. For output only. Or just for typical case. Or only if you hung on a resistor.

Solitron's is "worst case" bipolar compatible. Period.

Input can be as low as 0.4v for logic 0. 2.4v for logic 1. Any temperature between -55°C and $+125^{\circ}\text{C}$. Put it with any DTL or T²L and it'll work.

Of course compatibility isn't everything. Which is why we made our MOS ROM fast and versatile. (And static.)

Typical response 500ns. Worst case, 900ns. 1024 bits in four standard word-bit configurations.

Programmable chip select.

We also made it available. Order UC 6525/7525 now and you'll have it in four to six weeks with your bit pattern. Or contact us for details.

Solitron Devices, Inc., P.O. Box 1416,
San Diego, California 92112
Telephone (714) 278-8780
TWX 910-335-1221



(A part of Union Carbide is now part of Solitron.)

Auto- and cross-correlation analyses help engineers and researchers to learn more about signals generated from such sources as the human body, heavy machinery, jet engines and linear systems.

To aid in determining whether these powerful techniques can help you get more information from your experiments, we'll send you a copy of our new brochure. It provides useful applications information, and describes our newest signal correlators which feature:

- Real-time, on-line analysis
- Time delays from 500 ns to 207.5 s (Model 101A)
- Variable time constants
- Dc to 500 kHz range
- Optional Fourier transform accessory
- Optional computer interface system
- **New low prices: Model 100A \$6950; Model 101A \$8950**

Want to know more about signal correlation? You can get your copy of our new brochure with the coupon at right, or by calling (609) 924-6835.



PRINCETON APPLIED RESEARCH CORPORATION
P.O. Box 565, Princeton, New Jersey 08540

Gentlemen:

- Please send a copy of your Signal Correlator brochure.
- Please have a P.A.R. applications engineer contact me.

Name _____

Title _____

Organization _____

Address _____

City _____

State _____

ZIP _____

Phone (Area code) _____

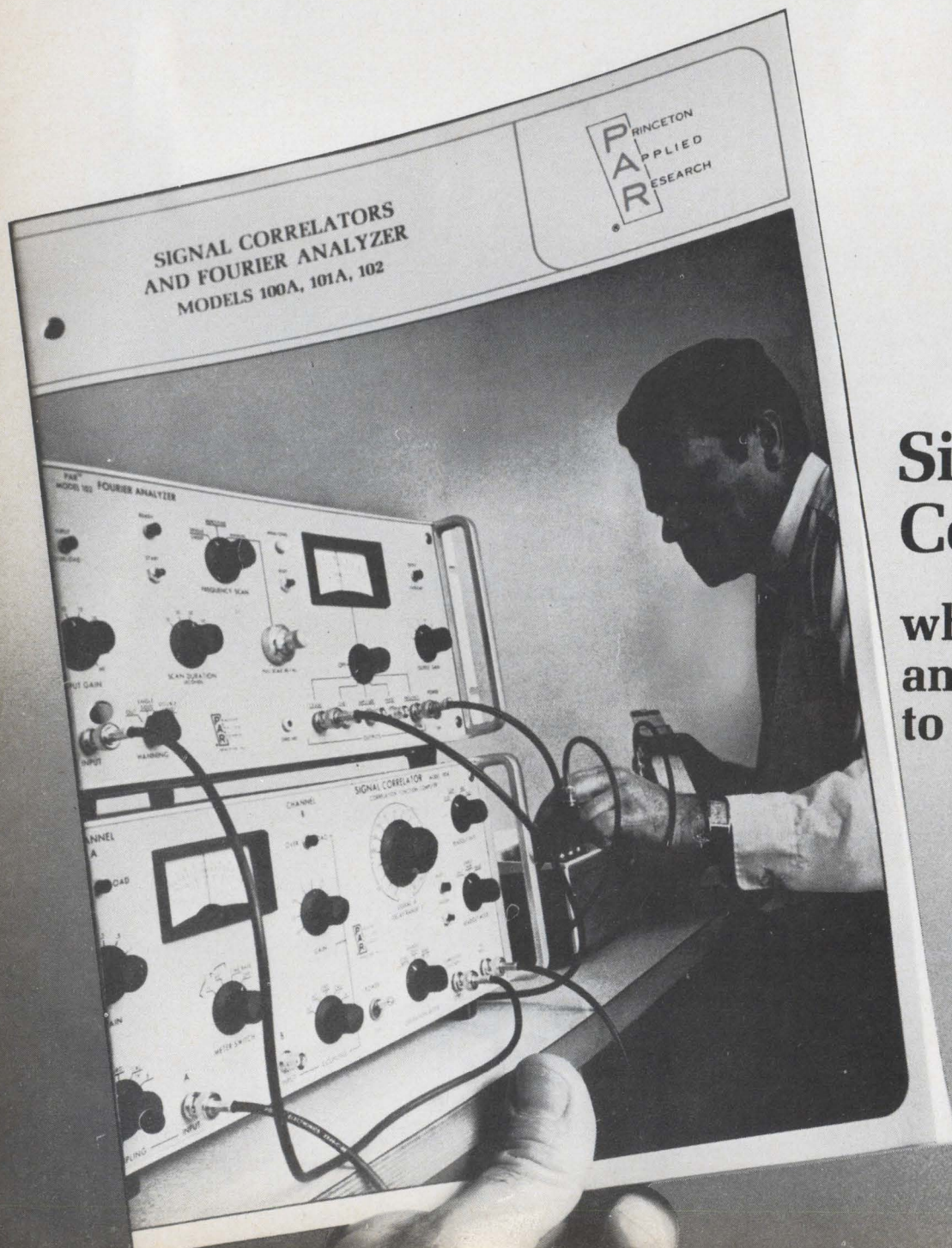

Signal Correlation...

what it is
and how
to use it.

Silicon technology simplifies devices

Properties within the silicon—and many other materials—provide semiconductor memory storage and circuit functions; technique eliminates p-n junctions

In recent years the IEEE show in New York has become less important for major technical announcements than many smaller, more specialized conferences. In fact, many engineers look at the convention more as a social week than as a time to keep up with new developments in their fields. This year, however, in one of the little noticed seminars—Silicon Devices in the 1970's—William S. Boyle, a Bell Telephone Laboratories scientist, mentioned what could be one of the most significant developments in a decade. Boyle and G.E. Smith have conceived and built a simple silicon device that can perform semiconductor memory storage and circuit functions without a junction by using just the properties of the silicon material itself. Already built by Bell is an experimental eight-bit shift register which can be used as a recirculating memory or as a delay line. In addition, light image and display devices, though not yet built, seem within reach.

The implications of a semiconductor technology requiring no junctions are enormous. For one thing, any semiconductor material—not just silicon—can be used to make use of its special properties. For another, no epitaxial layers, as required by bipolar devices, are needed; thus, this new technology eliminates many of the processing steps required in most diode fabrication—in fact, it can reduce most device fabrication procedures by a factor of four. And when one considers the size of the memory arrays required for today's computers, the results here could be revolutionary.

Simple. In concept, the new semiconductor device is exceedingly simple—a fact that should

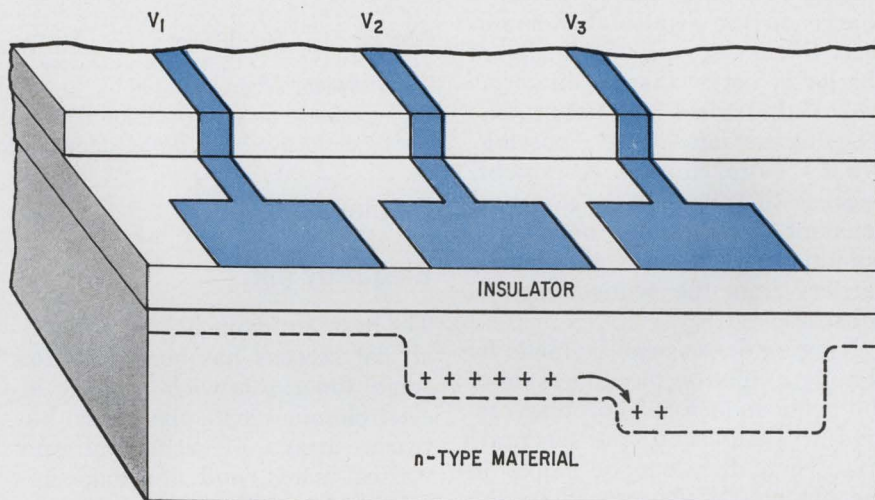

Bell ringer. The new coupled-charge semiconductor device moves charges from conductor point to point by applying a voltage V_3 greater than V_2 , which produces a deeper potential well at V_3 to spill the charges into that well.

greatly enhance its appeal. Stated most simply, charges are stored in (coupled to) potential wells—spatially defined depletion regions—at the surface of a device. The charges can be moved over the surface simply by moving the potential well by means of a suitable potential applied to another spatially defined region. Since the charges are coupled to the potential well, they move with it. Thus, the charge can be moved about the surface of the device by moving the potential wells. The process of injecting a charge into the potential well, transferring it over the device's surface, and then detecting it later at some other location forms the basis of the circuit operation. And this is done without windows into the semiconductor—no holes drilled, no wires.

In these first devices built by Bell, silicon technology construction was used. A silicon-dioxide insulating layer is deposited onto an n-type silicon substrate. A metal-

conducting pattern is then deposited on the insulating layer which forms an array of conductor-insulator-semiconductor capacitors.

Forms well. In operation, a bias potential applied to the silicon substrate forms a depletion layer at the surface of the substrate. A potential greater than the bias is then applied to a conductor to form a potential well at that location. Now when minority carriers or holes are introduced into the silicon substrate—say, from a light image incident on the bottom of the substrate—these holes will collect in the potential well at the semiconductor surface. The logic is then performed by moving the charges—via movement of the wells—and by detecting and measuring, where the detection at any electrode can be accomplished two ways: by sensing the capacitance change due to the presence of a charge, or by measuring the electrode potential directly.

The easy manipulation of carriers

U.S. Reports

on the surface of a semiconductor leads immediately to shift-register applications. In addition to the device, a charge generator is required at one end and a detector at the other end. One method of generation could be via surface avalanching in metal oxide semiconductors or by using light to induce electron-hole pairs. Detection could be accomplished by sensing the change of capacitance with a charge on the semiconductor surface. Since the rate of transfer of charge is better than a microsecond, shift registers at better than megahertz rates are possible. What's more, storage is possible because there is a fairly long time constant (in seconds) before the potential wells fill up with minority carriers from the semiconductor's substrate.

Imaging devices can be made by shining a light on the underside of the semiconductor. The holes created will diffuse to the electrode side where they can be stored in the potential wells created by the negatively charged electrodes. The image can then be read out by the shift register action. Displays can be made simply by reversing the process.

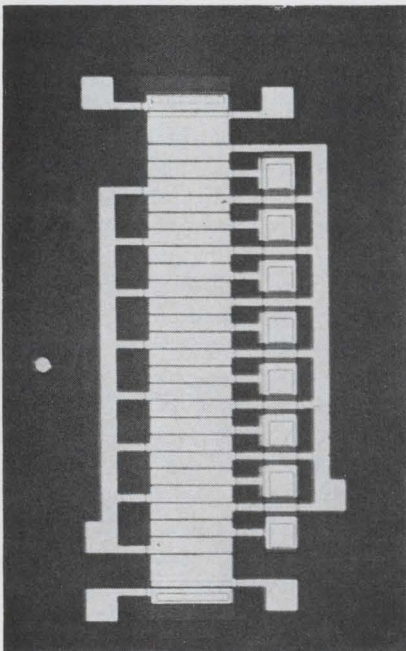

Product. Bell's simple shift register has an 8-bit capacity that's capable of megahertz speeds. It does not require p-n junctions.

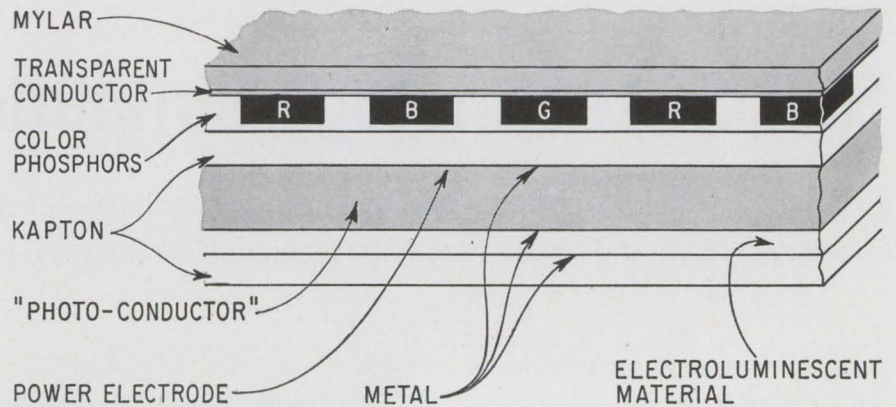

Tv sandwich. When a spot in the lower electroluminescent layer lights in response to an electrical signal on the metal matrix, impedance of the photoconductive layer drops, allowing color phosphor to glow.

Displays

Elegantly flat

The basic principle behind virtually all flat screens has been used for some time: sandwich a layer of electroluminescent phosphors between arrays of horizontal and vertical wires, and a voltage applied to a pair of these perpendicular wires will cause a spot to glow at their intersection. This is the approach used, for example, in two recently announced flat-screen developments, one by Matsushima Wireless Research Laboratory of Tokyo [*Electronics*, March 17, 1969, p. 114] and another by Autotelic Industries of Fort Erie, Ont., Canada [*Electronics*, Feb. 16, p. 70]. But the big problems today are getting adequate brightness and simplifying the addressing circuitry.

However, International Scanning Devices of Fort Erie—Autotelic is a spinoff—may have come up with an elegantly simple solution. It uses a sort of light amplifier to give an easily viewable display and makes use of a glow-discharge technique to scan the screen. Both the light amplifier and the glow-discharge apparatus are integral to the screen; in fact, the entire screen can be fabricated as a sandwich of plastic films with a total thickness of 0.010 inch.

Rolling along. The screen can be made by efficient, continuous processing (rolls of plastic film would automatically be unwound and subjected to the various coating and

photolithographic steps). Moreover, the materials in the panel are either inexpensive or used in minuscule quantities. Company president Louis P. Miranda, therefore, hopes for a selling price that will be a small fraction of that of cathode-ray tubes. In addition, the panel reduces the external-circuitry requirements and the cost of the tv set will be correspondingly less than that of a conventional crt set. As a result, Miranda sees a vast market in underdeveloped countries as well as in more advanced ones.

The cross-section shows how the light-amplifier works. The electroluminescent material glows when the horizontal and vertical lines intersecting a particular point are energized. But this glow is weak and fades fast because it's not practical to switch large amounts of power through the matrix.

The light, however, passes into an adjacent layer of photoconductive material—the light amplifier. Under the influence of the light, the impedance of the photoconductive layer drops sharply, so that a conductive path is established between a power electrode and metal leading to a surface electroluminescent layer. Because of the large potential difference between the power electrode and a transparent conductive film, the surface electroluminescent layer between them glows brightly, and this is what is seen by the viewer.

Time counts. Lawrence S. Sliker, director of R&D for International Scanning, feels that "light ampli-

fier" is a somewhat imprecise description. He prefers to call it a "light-dependent impedance-switching storage layer." He explains: "A pulse of light from the x-y matrix causes a very fast impedance change in about 10 nanoseconds—a change of about 100 to 1 in impedance. So the surface electroluminescent layer gives off light for something like 30 milliseconds rather than the 70 to 400 nsec that the matrix electroluminescent layer lights up." To the eye, therefore, the spot is brighter.

For scanning this display, all horizontal lines are enclosed in a glass bubble at each side of the screen. The glass is filled with an inert gas at low pressure (in production the bubble will be plastic). Within each bubble, there is a gap—that is, the lines are open. There is a similar arrangement for the vertical lines, with bubbles at the top and bottom of the screen.

Here's what happens: A pair of trigger electrodes in the bubble receives a high-voltage pulse and establishes a glow discharge across the gap between them. (The gap is about a millimeter wide.) Simultaneously, a sustaining voltage is applied to the other lines in the bubble. When the trigger pulse is removed from the trigger electrodes, the glow discharge is extinguished there, but transfers itself via diffusing ions and electrons to the gap of Line 1. The glow discharge continues there until a capacitor on the line is all charged, whereupon the discharge on Line 1 is extinguished and moves on by the same mechanism to Line 2. Integrated capacitors will be deposited in production versions.

Either way. For a monochrome display, the surface electroluminescent layer would be a continuous film of phosphors. For a color display, each intersection in the matrix has a discrete red, green, or blue phosphor above it in the surface layer. The luminance signal is applied to horizontal lines in the matrix, and the chrominance signal is applied to vertical lines. With this configuration, it's possible to take advantage of the phase relationship between the chrominance signal and the 3.58-megahertz

reference signal to provide a full-color tv picture.

So far, the company has built monochrome displays for demonstration purposes; these are small, perhaps an inch wide. The company is now having photolithographic masks made for a 14-inch-wide color panel, and has formulated the color phosphors. International Scanning has had preliminary designs done for large-scale vacuum-processing equipment, and estimates that it will be in full production in about two years.

Companies

Wire walking

At a time when management men at many firms in the memory business are wondering if they should jump on the MOS bandwagon, little (12 employees) Nemonic Data Systems think it has a better idea: Building and stocking plated wire and plated-wire planes, stacks, and systems without waiting for big orders to materialize.

Core memory manufacturers who also make plated wire have either abandoned wire because they

couldn't make it well or figured they couldn't make it profitably, or they've hesitated to commit themselves to volume production without firm purchase orders in hand. This is the trend that Robert A. Fillingham, the 35-year-old president of Nemonic, wants his fledgling firm to buck. Having moved into a 16,000-square-foot facility in Denver, Colo., last month just after the firm was founded, Nemonic will be producing a million bits of usable wire per month by the end of July, will have planes and stacks available about the same time, and will introduce its first prototype systems by early fall.

Stock it to 'em. "We're going to operate like the people in the MOS business," Fillingham says. "They don't wait for orders to come in. Ferroxcube won't go out and build 200 plated-wire systems a year. Neither will Lockheed Electronics. But we will, and nobody has done this to date."

It's significant that Fillingham ticks off Ferroxcube and Lockheed Electronics. Some of his best people came from those two firms, and the ex-Ferroxcube contingent, headed by Carlos F. Chong, worked at Univac in a pretty respectable plated-wire operation. Then Fillingham lured Lloyd D.

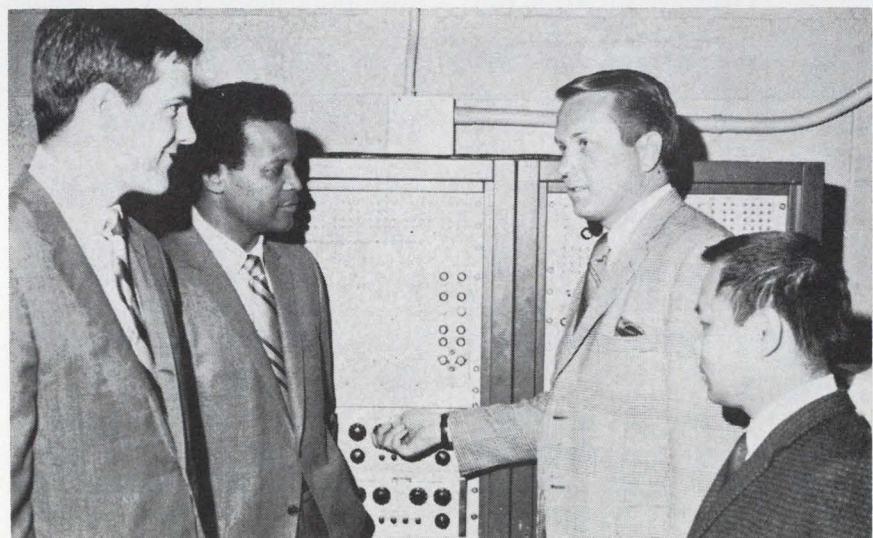

Getting wired. The founder of Nemonic Data Systems, Robert A. Fillingham, who is going to stock plated-wire memories, is shown third from left; the others are Stephen D. Hall, vice president for administration and finance; Lloyd D. Ransom, formerly with Lockheed Electronics and now Nemonic's vice president for material processes; and Carlos F. Chong, who left Ferroxcube to become vice president for engineering.

U.S. Reports

Ransom away from Lockheed Electronics, which Fillingham says was making the finest plated wire available on a production basis.

Nemonic's president got a line on his talented team when he was given the task, while at Stromberg-Carlson, of assessing whether or not that firm should be in the plated-wire business. He advised Stromberg-Carlson against it, but gathered a formidable group, which, armed with Stromberg-Carlson patents, equipment, and financing (a 20% interest in Nemonic Data Systems), set forth to fill the gap that he perceived between cores and semiconductor memories.

The gap is this, as Fillingham sees it: cores have about bottomed out. "They can't get much cheaper," he says. "Cores are mostly working at 750 nanoseconds to 1 microsecond, and these are 20-mil-diameter cores. To get faster, you need smaller cores, and these are expensive to string. So when a core memory gets into the 750-nsec region or faster we can beat them on price, and we're also certain that we can beat the socks off them in speed."

All in the family. For comparison purposes, Fillingham points out that Nemonic next year will have a mainframe computer-memory system packing 300,000 to 640,000 bits of storage into its NM-3 family with prices of 2 cents to 4 cents a bit. NM-3 will be available next year, with word sizes ranging from 8,000 to 65,000 at 8 to 40 bits per word, and a read-write time of 550 nsec. There will be earlier systems offered as standard products; but this family offers a good comparison for cores on the common basis of size, speed, and price.

At the other end of the memory market, Nemonic sees itself competing with semiconductor memories. Fillingham feels this arena could be profitable because semiconductor memories aren't yet plentiful, they're expensive in relation to Nemonic's projected prices, and they look like they'll be limited in size for a few years to systems from 50,000 bits to 70,000 bits. "I've seen price projections for bi-

polar memories of 10 cents a bit by 1972-73," Fillingham notes, "and MOS at not much less than 3 cents a bit. But these are for small-size, high-speed memories, and we're simply not interested in that kind of business."

"I believe people are just beginning to wake up and believe that MOS still isn't here," Fillingham adds. "We recognized it five months ago, and we know that wire is available and is a proven technology."

Nemonic's first system, NM-1, will reach the market around the first of October. Fillingham describes it as a family of medium-capacity, high-speed memories for typical core applications, such as 4,000 to 16,000 words varying from eight to 40 bits. Access time will be 200 nsec, read time 300 nsec, write time 450 nsec, and write after read will take 500 nsec. Entries in the family will sell for 8 cents a bit in quantity.

Propagation. The NM-2 family will follow. These will be medium-capacity, very high-speed memories. The size will vary from 36,000 to 160,000 bits at 512 to 8,000 words, with 18 to 160 bits per word. Access time will be 125 nsec, read time will be 150 nsec, a write operation will take 200 nsec, and total read-write time will be 325 nsec. In quantity, the NM-2 family will cost from 6 cents to 16 cents per bit. Fillingham says the capacity and speed make these units well suited for integrated circuit tester applications.

Then comes the NM-3 family in 1971, and by mid-1972, Nemonic will have a bulk-memory family, the NM-4, which at 5 million bits could serve as a replacement memory for IBM 360 bulk units. They'll have from 131,000 to 524,000 words, with 8 to 40 bits per word. Depending on the operation, speeds will be 300 nsec for access, 400 nsec for read, 650 nsec for write, and 850 nsec for read-write. The price will be about 1 cent a bit or less in quantity. Fillingham says such bulk units now sell for 2.5 cents to 3 cents a bit, and that the NM-4 will be a strong competitor at 0.5 cents to 1 cent a bit "if the quantity is there."

Government

Technology plateau

Future Federal support of R&D will level off somewhere between the \$15.3 billion and \$16.5 billion range of the past five years after nearly doubling in the first half of the 1960's. That grim forecast by the National Science Foundation is read as representing a net decline in R&D purchasing power in a period when a hot economy is still in the early stages of cooling.

Industrial and academic research and engineering staffs unhappy

Coast to coast

California received 27% of total Federal R&D obligations in fiscal 1968, followed by New York, 8%; Maryland and Texas, 6% each and Florida, 5%. Reports on geographic distribution, however, contain an element of redistribution due to subcontracting. For example, of NASA's \$3.5 billion prime contracts, \$346 million crossed state lines. Biggest losers were New York, \$83.4 million, and California, which lost \$55.6 million.

with the forecast get little solace from the NSF, which attributes the funding plateau to a "prevailing mood of skepticism about the place of science in solving fundamental problems"—including the Vietnam war, which itself has been responsible for draining off Federal money that might otherwise have gone for R&D.

Trends. Alarming as the overall trend may be, engineering in general and electronics engineering in particular is getting more U.S. money. Fiscal 1970 support of electrical engineering R&D, for example, is up \$40 million to \$367 million. And that figure doesn't include money spent for electronics engineering under budgets for aeronautics and astronautics.

On the other hand, industry has reason for concern about the NSF's

SLO-SYN[®]

Photo Artwork Generator draws with light ... like lightning!



Put your instructions on tape right from the rough, grid paper sketch. Then let the numerically controlled SLO-SYN Photo Artwork Generator take over. It produces on film or glass plate an accurate circuit pattern to finished board size up to 11 x 18 inches. No manual drafting. No photographic reductions. You cut a normal 40 hour operation to 8 hours or less.

Your image can be round or square, a letter or number, a schematic symbol, line or just about any character you want. Quick-change disks multiply the unit's versatility. To obtain precision micro-circuit masks, generate artwork at 100X size for conventional reduction and step-and-repeat techniques. Start with simple manual programming and adapt it later to digitizer or computer-aided techniques if you wish. Use it by itself or as part of a complete system of SLO-SYN tape controlled equipment such as drilling machines, eyelet inserters and wire terminating machines.

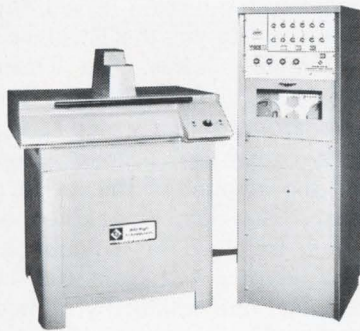

The price? You can have a SLO-SYN Photo Artwork Generator for less than \$30,000 or you can lease. Either way, start with the full information by calling or writing The Superior Electric Company, Bristol, Connecticut 06010. Phone 203/582-9561.



SUPERIOR ELECTRIC

U.S. Reports

notation that the private sector's share of R&D money fell from 66% to 58% in the years between 1963 and 1970, while the work performed at Federal and university facilities increased steadily. Some of this shift is due to cutbacks in NASA programs, the NSF points out.

The Defense Department-NASA-Atomic Energy Commission R&D share—which the NSF lumps together because their programs “tend to be similar in nature”—will drop to less than 85% of total Federal funding, from 90% during 1960-1965. Budgets at other agencies, however, will rise to 17% in 1970 from about 10% in 1960-1965. Agencies in this latter group include Health, Education and Welfare; Commerce; Transportation; Agriculture; and Interior Departments, with the bulk of their programs now slanted more strongly to research than development.

A bigger R&D outlay by the civil agencies will account for a relatively higher growth rate of research over development. Since 1966, the NSF says, development obligations have decreased, and the trend will continue throughout 1970, with basic and applied research taking a larger share.

Less growth. Basic research is running about 14% of total R&D outlays, after growing 9% from 1956-64 and only 7% in 1964-70. For applied research, which consumes from 20% to 23% of R&D outlay, the NSF says funds “will remain at least at their present levels.” The 1970 estimate for applied research is \$3.71 billion, with the Defense and Health Departments and NASA taking the lion's share. The NSF attributes a \$234 million increase in the Defense Department's 1970 applied-research outlay for design work on the Air Force's Advanced Manned Strategic Aircraft.

Industry also is getting a small share of the Government's applied research. The NSF records a major shift in applied research, with the industry portion dropping from 45% in 1963 to 30% in 1969—which the NSF again attributes to changes in Defense Department and NASA programs.

Funding for development has

suffered a yearly drop since the outlay of \$11.3 billion in 1967. The outlay for 1969 was \$10.4 billion; that for 1970 will be at least \$525 million less because of the cancellation of the Manned Orbiting Laboratory program. Another factor in shrinking development outlays is NASA's completion of expensive development phases of the Lunar Landing program.

Overview. Though the Defense Department still provides half the nation's R&D funds, that share has dropped from the 77% it was ten years ago. In 1969 NASA provided 24% and the AEC 9%, but the HEW and Transportation Departments and the National Science Foundation shares of the total are growing.

The NSF hints that the share of civilian R&D in the total R&D outlay will continue to grow, as indicated by the establishment of the Federal Government as the central support of nationwide R&D in such areas as health and food research, natural resources management, transportation, and studies of human behavior, and education. Environmental and social science will grow “noticeably” in the future, says the NSF. Life sciences and engineering currently lead in research support.

Though the Defense Department, NASA, and the AEC have and will continue to provide most of the R&D funds, their outlays “may have less weight in the total Federal effort,” says the NSF, because their programs overlap those of the civilian agencies. Examples the NSF gives: the AEC's programs in water desalting which are closely coordinated with the Interior Department, and NASA's program to develop weather satellites for the Environmental Science Services Administration.

Commercial electronics

Minding the store

Department store executives, burned by computer marketeers who promised them the moon a decade ago, are cautiously having another try at testing electronic point-of-sale systems for inventory

control and credit-verification. One of the most recent credit-checking installations to go on line linked a May Co. store in Torrance, Calif., with the downtown Los Angeles credit department earlier this month in a system designed and built by TRW Data Systems. The TRW company acquired the nucleus of hardware and management expertise reflected in the Credifier 3300 system when it acquired the seven-year-old former Credifier Corp. last December.

Although Credifier 3300 is limited to credit verification, that's all the May Co. wants from it. The off-line inventory control system being tested is provided by Ricca Data Systems of Santa Ana, Calif.

There are at least three ways to verify a customer's credit—with a negative system, in which only known bad-risk account numbers or lost or stolen credit card numbers are stored; with a full positive system, in which all account numbers are stored and updated; and with a positive-by-exception scheme, in which accounts with some condition attached to them are stored and updated.

Middle of the road. The Credifier 3300 on 90-day trial at the May Co. is a positive-by-exception system, which is less ambitious than a full positive system. The conditions applied to the 216,000 accounts (out of 500,000 normally active ones) vary. Some may be new customers from whom the retailer wants more credit experience before granting the normal \$100 limit. Included could be the account numbers of known lost or stolen credit cards, or accounts of very good customers to whom the \$100 limit doesn't apply.

The system uses a leased duplex phone line linking the Torrance and Los Angeles sites. The Torrance store has more than 100 terminal keyboards through which the sales clerk enters the account number and the amount of the credit purchase. The data is handled by a buffer, followed by a communications adapter that scans the buffer modules, and finally by a modem at the Torrance store. It's transmitted over the hot line to a modem in the Los Angeles store's credit

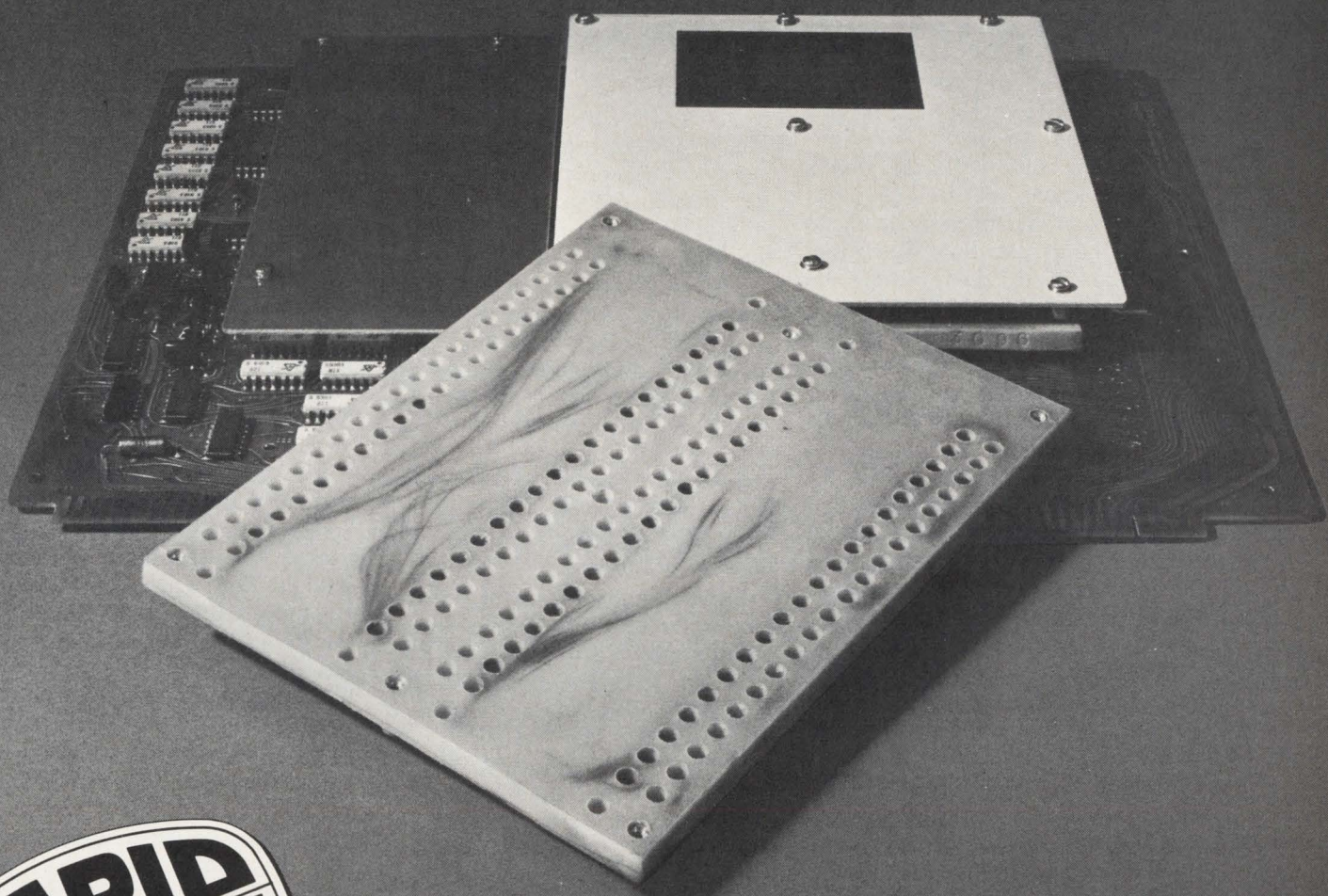

Plug in New ROM Contents in only 72 hours

READ-Only memory contents always seem to change at the last minute. No problem with Memory Technology Memories. Just ask for "Rapid Braid" Service. We'll sticker your order for "RUSH," and your all-new contents "braid" will be shipped within 72 hours after receipt of your specification. No fuss. Just unplug the old, plug in the new. (Of course, you can change a small number of words, yourself, in less than 30 minutes.)

Why not learn more about our rapid braid service — and about our READ-Only memory systems. Ask for a copy of An Engineering Guide to Read-Only Memory Systems. We'll include a Rapid Braid sticker for you, too. Write Memory Technology Inc. 83 Boston Post Road, Sudbury, Massachusetts 01776.

Memory Technology
Incorporated

U.S. Reports

department, from which it's relayed to the central processing unit. This consists of a distributor, two processors, and five disks, each with a 10-million-bit capacity.

The distributor polls the store's communications adapter and determines if a processor is available to handle the transaction; the processor then pulls the account file from the desk. If no condition is attached to that account—if no disk information identifies the card as lost or stolen—or the customer hasn't exceeded his \$100 limit, the clerk gets a green light to complete the sale in about one second on an unobtrusively located console. The transaction has been added to the customer's previous balance and checked against the "open-to-buy" file to determine that the customer is still under the \$100 limit.

Warning. If there is a restriction on the account, the clerk will get an amber or red signal. A red light can be a signal to the clerk to retain the credit card or call store security. If the clerk gets an amber light, she goes off line, picks up a phone to call central credit.

This is where the credit authorizer's terminal comes into play. When the Torrance clerk calls, the authorizer punches the account number and sale amount on the terminal's keyboard, then gets a readout of the customer's balance on the bar-code display tubes on the face of the terminal.

If she wants more data, she can access a master file showing the customer's nine-month account history, but this is not an electronic search, and takes longer. If she can bypass the master file, she has the information to authorize the sale in about 6 seconds, and no more than 45 seconds is required from the time the store clerk picks up the phone until she has her instruction.

If the May Co. adopts the 3300 for its 17 Southern California stores, TRW officials estimate, the complete network would rent for about \$10,000 a month. This is the first venture into the competitive arena of electronic retailing aids by the diversification-minded TRW Systems Group, which formed TRW Data Systems with the acquisition of Credifier.

Industrial Electronics

Printout

The bureaucratic dream of matching two fingerprints from a file of 200 million in a matter of seconds is still far from realization. But the Autonetics division of North American Rockwell is making modest progress toward that goal with a second generation fingerprint reader, the outgrowth of a bread-board model built for the FBI during a recently completed three-year, \$111,000 study. Autonetics and Cornell Aeronautical Laboratories were selected from among 30 competing firms to conduct the feasibility studies.

Engineering versions of the Autonetics reader are still somewhat bulky, requiring a desk-sized console, but production models are expected to be only as large as a desk drawer.

Quick look. A flying-spot scanner and six photomultiplier tubes scan each of 300,000 sectors on a 500-by-600-line grid into which each 1.5-by-1.25-inch fingerprint is divided. The lower limit of resolution is about 2.5 mils. Using a proprietary technique, the scanner searches each sector for light and dark ridge patterns.

To minimize the amount of computer memory required, the data, after analog-to-digital conversion, is fed into 192 circulating shift registers of 32 bits each, which, in effect, gives a black-white scale from 1 to 32 for each point reading. When the registers are filled, parallel logic-sampling gates connected to the registers examine and store in the computer memory only that data which is found significant in identifying the print.

The significant data consists of the total number of minutiae, or bifurcations and ridge endings, found in a print. Each minutia picked up by the spot scanner and identified by the logic gates is stored in the computer as an x-y plot point, with an indicator showing its direction. Logic in the system causes the spot scanner to skip blank portions of the fingerprints, or those with a broken structure caused by scar tissue.

The output of the reader is a series of binary words that gives the x-y location and orientation of all minutiae on a particular print—in effect, a map of characteristics unique to that print. The computer matches the print with any identical plot pattern in its file.

Deviations. The number of minutiae in a fingerprint ranges from 25 to 300, and the reader can detect about 85% of them, usually an acceptable accuracy. Reliability drops sharply, however, with prints that have only a small number of minutiae.

The reader now takes 30 seconds to scan a print, but Autonetics spokesmen say they hope to increase the speed in production models. This will require improved electronics for handling data from the flying-spot scanner, and mechanization of the fingerprint card handling, which is now done manually.

Harry W. Martin, program marketing manager, says reliability for the system is still not acceptable, primarily because of variations in how the same print shows up on different fingerprint cards. The amount of pressure applied when the print is taken affects the pattern. Although the reader can automatically adjust to varying ridge widths of from 5 to 15 mils on the print, Martin says, "a little more work is still needed to increase reliability." Other improvements may include image enhancement, using a cathode-ray tube with a brighter image and faster phosphorus decay time, and new system logic to eliminate false alarms from ink smudges and other anomalies.

Computers

SuperSTAR

After years of building supercomputers with discrete components, the Control Data Corp. is making the switch to integrated circuits with its latest outsized creation—the CDC STAR. The name is an acronym for "string array," derived from the system's "pipeline" architecture. It seems appropriate for

Brand-Rex reaches into the 25th Century for its new spokesman

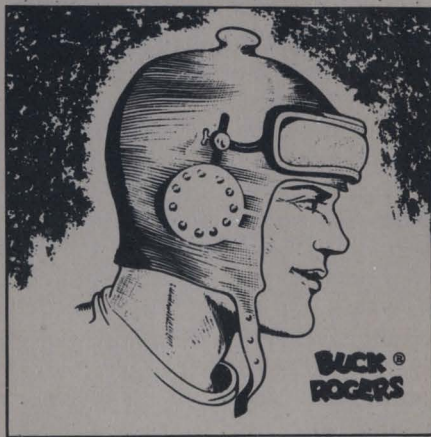

Willimantic, Conn. Planet Earth — The Brand-Rex Division of American Enka Corp., a leading manufacturer of wire, cable and insulating materials, announced today at a special conference that it has appointed the world-renowned science fiction hero, Buck Rogers, as its new spokesman. "Buck Rogers was selected for the post because of his reputation as a man who is way ahead of his time," said Mr. John P. O'Connor, Director of Sales and Marketing, at Brand-Rex.

"Buck Rogers stands for the promise of the future, just as the Brand-Rex wire and cable you install for trouble-free operation today promises greater growth potential for tomorrow. Like Buck Rogers, Brand-Rex is way

ahead," he continued.

To illustrate this, Mr. O'Connor cited recent Brand-Rex advances in several fields. For the telephone industry, Brand-Rex is intimately involved in new types of wire and cable to meet the growing needs of "total communications," such as, data transmission and telemetry, CATV and microwave systems. For the computer industry, in which the company is the leading wire and cable supplier, Brand-Rex continues to develop thousands of new designs each year for new generations of computers and peripheral equipment. For industrial plants and utilities, the company is advancing the state of the art in control cables, particularly those sophisticated electronic types demanded by accelerating computerization and automation.

Mr. Harry Wasiele, Jr., Brand-Rex General Manager, stated that he was extremely optimistic about Buck's alliance with the company.

"I feel the Adventures of Buck Rogers will be an excellent way to illustrate the many Brand-Rex advances in wire and cable for communications and electronics," he said.

"It should be an exciting and informative series."

9412

FROM



HEADS the LIST of 5 HIGH POWER OPERATIONAL AMPLIFIERS

— from 200 mA to
10 Amps — up to 235v/ μ S

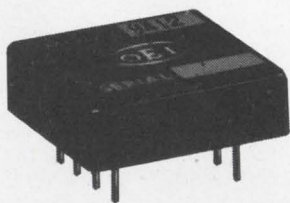

1" x 1" x 0.31" deep

MODEL 9412 OFFERS:

- ± 10 Volts Swing
- ± 200 mA Output Current
- ± 235 Volts/ μ S Slew Rate
- 350 MHz Unity Gain Frequency
- 50nS 0.1% Settling Time
- Size: 0.31 cubic inch

Complete specifications on request.

Units in stock for
immediate shipment.

Note these low prices:

\$52.00 — 1-2
\$47.00 — 3-9
\$43.00 — 10-29
\$39.00 — 30-99
\$36.00 — 100-299



OPTICAL ELECTRONICS INC.

P. O. Box 11140 Tucson, Arizona 85706

Phone 602/624-8358

U.S. Reports

a 40-nanosecond-cycle system designed to dramatically outpace the IBM 360/195 and the CDC 7600 in a variety of tasks.

The STAR will remain a starlet, however, until formal announcement and subsequent delivery of the first experimental machine to Lawrence Radiation Laboratory, Livermore, Calif., sometime before Aug. 1, 1971. Another possible customer for STAR: The Pentagon antiballistic-missile defense system, which gave advanced data processing study awards to both CDC and IBM earlier this year [*Electronics*, Feb. 16, p. 142].

The firsts. Technology and personality are included in Control Data's list of departures from past practice with STAR: it is the first CDC machine designed to use emitter-coupled logic circuits throughout, and it is the company's first computer designed by vice president James E. Thornton—instead of chief designer Seymour Cray.

Thornton says the STAR will be much faster than existing machines on some tasks, barely faster on others. A principal appeal, he adds, will be in processing large matrices, long the strong suit of CDC's systems. At Livermore, data processing officials at the Nuclear Weapons Development Centers say STAR's most important feature will be its ability to simultaneously perform arithmetic and logic functions.

The STAR will differ from earlier supercomputers, Thornton asserts, by using pipeline architecture throughout the arithmetic unit instead of being limited to instruction-processing units. The pipeline concept, he explains, is analogous to an assembly line connecting input and output memories. As a "cloud of bits" flows through the pipe, the tightly overlapped stream of floating-point and fixed-point data and instructions are processed simultaneously, instead of the essentially sequential handling of different types of data that is characteristic of earlier machines.

Specifications. STAR's 32-way interleaved central memory will boast 32 million bits of ferrite core with a 1.6-microsecond cycle time. Transistor-register buffering is included in the design; but there will

be no separate buffer memory as in the IBM 360/195. Peripherals to be hung on the Livermore machine include a 5-billion-bit disk-storage system and two 4.5-million-bit memory drums. Additional subsystems are not planned for purchase with the mainframe, although CDC says communications capability is assured by an input-output multiplexer with 12 medium-speed channels of 16 bits each, one 256-bit higher-speed direct-access channel, plus another 45 channels for memory units and controls.

Software won't be delivered with the first system, but the Army's Advanced Ballistic Missile Defense Agency has funded CDC for development of a high-level compiler to optimize the STAR's very high processing capability. The agency's interests lie in the STAR's potential for ABM control systems. Pending such a development, Thornton says, Fortran and Cobol compilers will be adaptable for use with STAR.

What about the future? Control Data apparently plans to introduce its supersystem commercially after its first delivery to Livermore next year. But, in an era when minimachines are booming, the appeal of CDC's \$15 million-plus maxi certainly will be limited. Apart from military and nuclear science applications, industry specialists see but one other developing market—the computer utility. And, to profitably use the computer, says one, "It's going to have to be a helluva big utility with lots of sophisticated customers." But by the time the STAR is ready, he adds, the market may be there.

Instrumentation

Writing a check

Calibrating digital multimeters, differential voltmeters, resistance boxes, and differential amplifiers is expensive and time consuming. This is bad enough. But at many metrology laboratories, an exodus of trained technicians toward better-paying jobs is making life that much worse. However, a California company—the Jacobi Systems Corp.

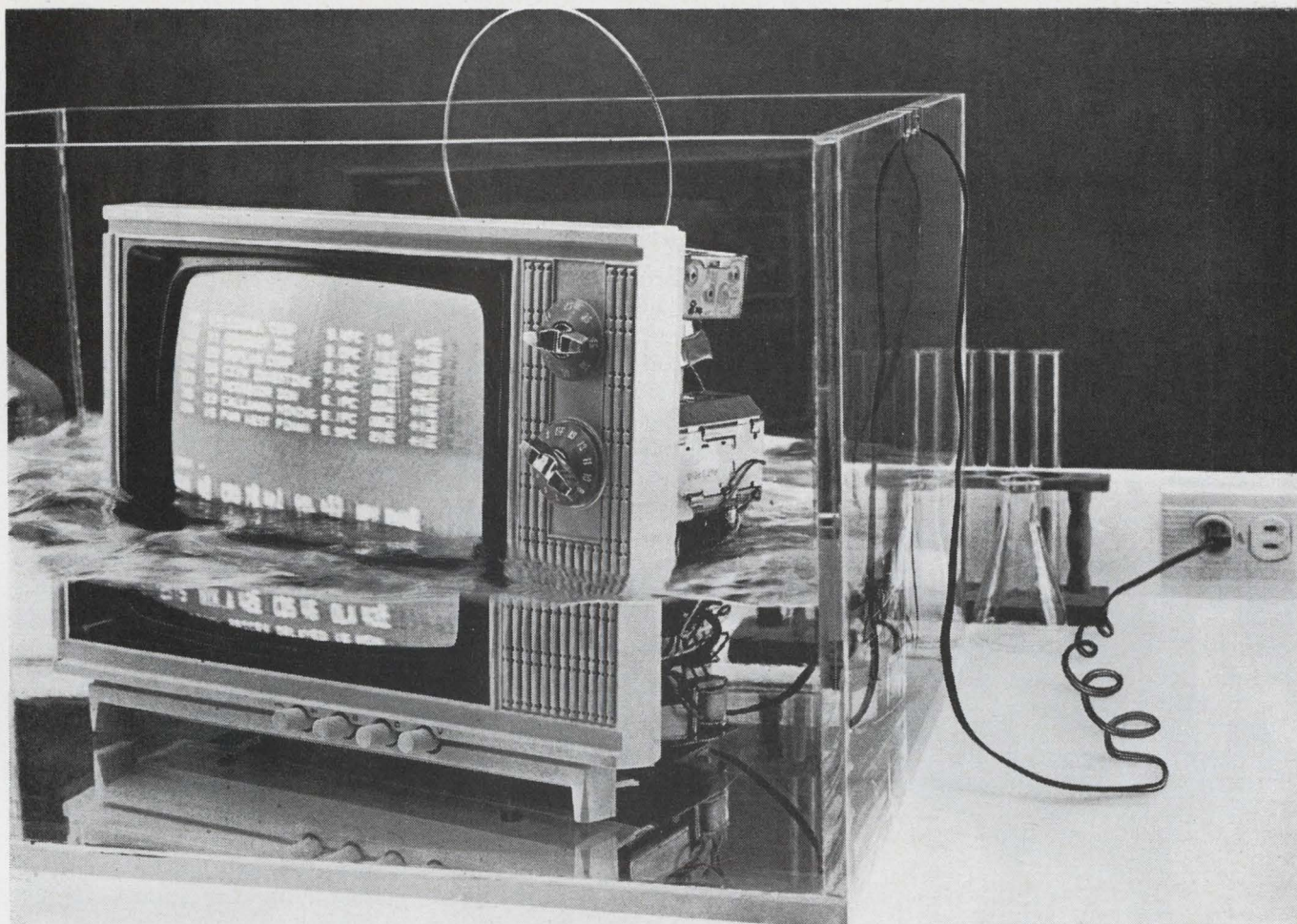

Our new dry test bath is getting a great reception

This should give you a pretty clear picture of what Fluorinert® Brand Electronic Liquids are all about.

They give you a dry test bath for temperature and gross leak testing of electronic and microelectronic units and integrated circuits. They detect flaws and leaks with great accuracy . . . and are efficient over a wide range of temperatures.

Fluorinert Liquids have high dielectric strength . . . which means you can safely test on-circuit. They do not react with the most sensitive of materials . . . which means you can test about anything.

Fluorinert Liquids drain clean, dry fast and leave no messy residue. You can use and ship units directly out of the test bath, without cleaning.

In fact, Fluorinert Electronic Liquids are now approved for the MIL-Standard 883 and the MIL-Standard 750A gross leak tests for microcircuits.

We have lots more information about this remarkable new test bath. The coupon will bring it all or call your local 3M representative.

Fluorinert® Electronic Liquids 3M BRAND COMPANY

3M Company, Chemical Division, 3M Center
St. Paul, Minn. 55101

Dept. KAX-3-70

Send me all the details about Fluorinert Brand Electronic Liquids.

Name _____

Company _____ Title _____

Address _____

City _____ State _____ Zip _____

**BUY
A KIT
SAVE
A LOT**

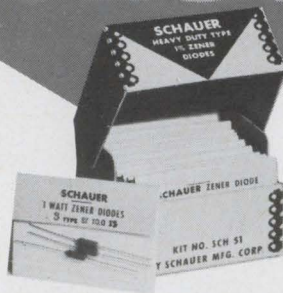

**1% TOLERANCE
SCHAUER
1-WATT ZENERS
A \$54.57 value, just**

\$24.50

Kit contains a 51-piece assortment of SCHAUER 1% tolerance 1-watt zeners covering the voltage range of 2.7 to 16.0. Three diodes of each voltage . . . packaged in reusable poly bags. Stored in a handy file box. Rating data sheet included.

Use these Schauer zeners over and over in laboratory prototypes as well as in precision test equipment. Contact your distributor or order direct. Schauer is #2 in the plastic encapsulated diode field, highest quality, the industry's lowest prices!

Semiconductor Division
SCHAUER
MANUFACTURING CORP.

4514 Alpine Ave., Cincinnati, Ohio 45242
Telephone: 513/791-3030

U.S. Reports

—has found a partial solution. It has put together an autometrology system called the J8100 that greatly reduces both the cost and time of calibrating instruments, and, in so doing, reduces the impact of the manpower shortage at some labs.

Jacobi has incorporated Atlas (abbreviated test language for avionics systems) in the J8100, which the company claims can do calibrations at one-seventh the cost and in one-seventh the time required for manual operations. The company believes it can sell the \$140,000 system to any facility where 100 or more instruments must be calibrated regularly.

According to Jacobi, yearly costs for manual calibration usually run from 7% to 15% of an instrument's purchase price. With the J8100, the company claims yearly calibration costs will run only from 1% to 2% of instrument cost. Calibration of a four-digit dvm, usually a task taking from 4 to 6 hours to complete, can now be done in a half hour, says the company; for a five-digit dvm, usually a 16-hour calibration job, the time is cut to just 1 hour.

Strong language. The system comes with 200 machine-language test programs on tape cassettes that can be specified by the user for various instrument models. Additional programmed cassettes are available at \$250 to \$350 each. The programs are written in Atlas, a standardized test specification language, using an Atlas compiler to translate each program into machine language. The compiler provides syntax and error checking, and yields a separate machine language output. Using the compiler, users also can prepare test programs, if they have access to a large, high-speed computer. Programming can be done directly in symbolic machine language, but Atlas is preferred because it doesn't require the programmer to learn machine language.

Input/output hardware includes a data entry keyboard, tape cassette reader-recorder, a cathode-ray tube alphanumeric display, a control panel numeric display, and an optional teleprinter. The control computer can be any of several

16-bit digital machines with a 4,096-to-32,768-word memory, such as the Varian 620, Honeywell 516, or Interdata Model 4. A remote timed-shared or dedicated computer also can be used. The system is in a single desk-sized console and the software operating system requires about 4,000 words of computer core memory.

Off-the-shelf calibration instruments, selected for high-accuracy, provide a-c and d-c sources. Included are a d-c current source programable in 1-, 10-, and 200-milliampere ranges; a resistance unit programable from 0 to 100 megohms; and a-c voltage source programable from 0 to 1,000 volts in five ranges; a d-c voltage source programable in 10-, 100-, and 1,000-volt ranges; an a-c rejection and noise test unit for measuring normal and common mode rejection and input noise; and a programable digital multimeter for instrument-under-test measurements and system self-test. An optional programable line conditioner can also supply primary power to the instrument being tested, at 0 to 260 volts rms and frequencies from 45 to 5,000 hertz.

Daily check. For high-accuracy calibration of dvm's with five digits or more, the system is referenced daily against a primary standard instrument to determine drift. The error is fed back into the computer, and all the system output levels are adjusted. According to Jacobi, the accuracy attained is equal to 24-hour stability specifications.

Robert Moore, manager of marketing, advanced systems, says J8100 is the first autometrology system able to perform common and normal mode and noise rejection tests for early detection and prediction of failures in instruments being tested.

The possibility of inaccurate calibration entries is eliminated, says Moore, "because the system operator is constantly questioned by the system, and any wrong answers can be flagged out to the teletypewriter." Test data management also is improved because information from the test run can—in addition to crt and teletype readout—be recorded on the system's cassette

Photocells ain't what they used to be...



they're a heck of a lot better

Photocells are doing jobs today that they couldn't have done ten—five—
or even two years ago. There have been that many improvements!

HIGHER STABILITY
MORE UNIFORM RESPONSE TO COLOR TEMPERATURE
HIGHER SPEED RESPONSE
WIDER VARIETY OF PACKAGES AND SIZES
INCREASED EFFICIENCY
HIGHER LINEARITIES

Let us show you how the "light touch in automation and control" can help
solve your problems. Call (914) 664-6602 or write Clairex,[®] 560 South
Third Avenue, Mount Vernon, New York 10550.

CLAIREX ELECTRONICS

A DIVISION OF CLAIREX CORPORATION

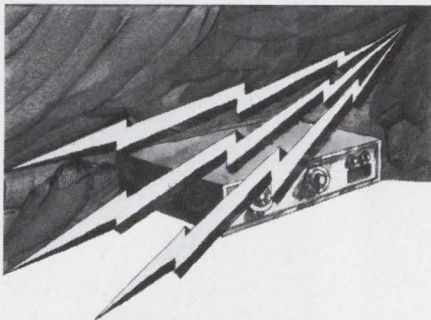

Rent- a Volt

Not very long ago, when your lab needed a precision amplifier or a voltage standard or almost any other piece of sophisticated electronic instrumentation, about the only way to obtain one was to buy it.

Not any longer. Now . . . through R.E.I. . . . you can rent almost any electronic instrument you can think of — without delay; without worrying about service and calibration; without wondering if it will become obsolete before you have a chance to turn it on; and without investing capital funds or making any sort of major commitment.

R.E.I. can give you the fastest service, the widest selection and the lowest rates of any rental firm in the country. One of our inventory centers is located near you, wherever you are, for instant delivery. Let us tell you more about the many advantages of renting vs. buying. Send today for your free copy of the new R.E.I. Instrument Rental Handbook.

Amplifiers	Filters	Power Supplies
Analyzers	Generators	Recorders
Attenuators	Meters	Sources
Bridges	Oscillators	Stroboscopes
Cameras	Oscilloscopes	Synthesizers
Counters	Plug-In Units	Test Chambers
Detectors	Generator/Synchronizer	

INSTANT INSTRUMENTS FROM THESE INVENTORY CENTERS:

Waltham, Mass. 02154
69 Hickory Drive
(617) 891-7610—Telex 923472

Anaheim, Calif. 92801
159 East Freedom Ave.
(714) 879-0561—Telex 655473

Gaithersburg, Md. 20760
16600 Oakmont Ave.
(301) 948-0620—Telex 898446

Rosemont, Ill. 60018
5607 Pearl St.
(312) 671-2464—Telex 726488

Ft. Lauderdale, Fla. 33308
4808 N.E. 10th Ave.
(305) 771-3500—Telex 51-4467

MORE INVENTORY CENTERS
COMING SOON



Rental Electronics inc.

A PEPSICO LEASING COMPANY

U.S. Reports

tapes and be saved for later statistical analysis.

Government

Bureaucratic pollution

Proposing reorganization of the myriad Federal environmental programs has itself become something of a mini-industry. But, action might actually be forthcoming soon because the authoritative voice of President Nixon's Council on Executive Reorganization, headed by Litton Industries president Roy L. Ash, is expected to recommend in May that the programs be restructured and probably consolidated.

The overall reorganization plan contains a proposal by Ash's council to reorganize the Budget Bureau, with Nixon assuming some of its operational powers, and renaming it the Office of Executive Management in the White House. It would serve as secretariat for a new domestic branch of the National Security Council.

The President's domestic affairs adviser, John D. Ehrlichman, noting the Administration's dismay over the diffusion of Federal programs throughout the Government, suspects "without really knowing" that Nixon will move for consolidation of various environmental functions in one agency.

Two roads. In any event, the clouds of proposals rolling out of the Capitol generally fall into two basic structural formulas.

The first would establish a new department or administration which would combine environmental programs of all Federal agencies. One such plan, by Senate Minority Leader Hugh Scott (R., Pa.) would set up an independent Environmental Quality Administration [*Electronics*, Feb. 16, p. 84]. Sen. Edmund S. Muskie (D., Me.) also wants a new authority, but any similarity in the Scott-Muskie proposals will probably be dwarfed by Senate debate over differences.

An alternative to an entirely new office would be changing the Department of Interior to the Department of Natural Resources.

For the record

Landing. An Army test program, directed by the Electronics Command, is trying to find out just what information helicopter pilots need to make successful instrument landings. Using A-Scan, a Ku-band scanning-beam landing system developed by Cutler-Hammer's AIL division, the tests are taking place at the FAA's National Aviation Facilities Experimental Center in Pleasantville, N.J. Areas to be investigated include: the guidance requirements for the steep glide-slope angles permitted by a microwave landing system; the problems introduced by wild and difficult terrain; ways to make several landings simultaneously using different lanes; and how to present the pilot with information about range, range rate, absolute altitude, and obstacles in his path. A-Scan consists of azimuth, elevation, and distance-measuring equipment (DME) units on the ground, and a receiver, digital processor, DME interrogator, and a control unit in the aircraft.

New line. Sanders Associates has organized a data-processing and data-communications subsidiary, Sanders Data Systems Inc. It will consolidate nearly all Sanders' commercial activities under Raymond A. Zack, a corporate vice president, fresh from Motorola where he was vice president and general manager of the Control Systems division. In addition to its displays, communications-processor line, and modular-memory and modem lines, Sanders will offer a new system 7000 composed of a Lockheed MAC computer, data-storage gear, and Sanders' own display input-outputs. More interesting, if more speculative, is president Royden C. Sanders' interest in a line of modular data-processing equipment including low-cost processors and inexpensive new display techniques. There's no timetable for this line's introduction, however.

Time on its hands. CompuTerminal, a new San Francisco time-sharer, is out to replace small in-

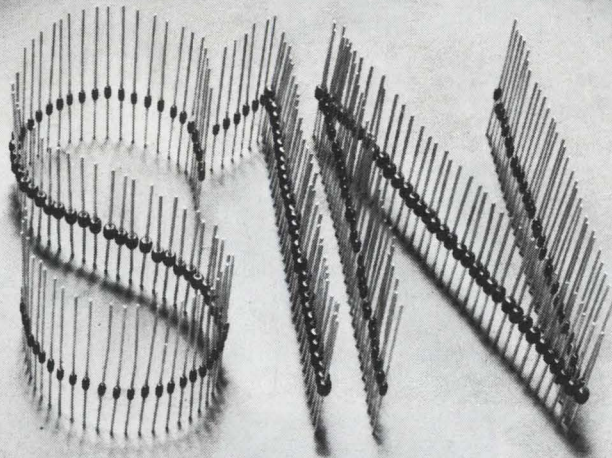

"METOXILITE" RECTIFIERS NASA Qualified — Now Available

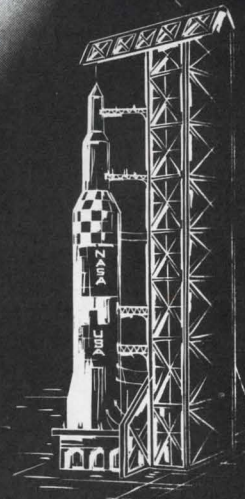

"METOXILITE", Semtech's new high-current axial lead monolithic silicon rectifier is now qualified by MFSC NASA.

"METOXILITE", a result of Semtech's advanced manufacturing techniques, offers the ultimate in ruggedness and hermeticity. All "SIN" devices are given 100% reliability screening in Semtech's qualified laboratories.

The metal oxides which form "METOXILITE'S" outer case material are fused directly to the high temperature metallurgically bonded assembly,

forming an impermeable subminiature package.

"METOXILITE", a general purpose rectifier suitable for all applications. Now available as "SIN" devices to meet existing and new space equipment requirements.

MSFC 85M03895

1 Amp General Purpose Rectifiers
SIN4245, SIN4247 & SIN4249
P.I.V. — 200, 600 & 1000 volts
 I_R @ P.I.V., 25°C — 100 nA

1 Amp Fast Recovery Rectifiers
SIN4942, SIN4946 & SIN4948
 T_{rr} — 150 & 500 nsec
P.I.V. — 200, 600 & 1000 volts
 I_R @ P.I.V., 25°C — 100 nA

MSFC 85M03896

3 Amp General Purpose Rectifiers
SIN5199 & SIN5201
P.I.V. — 200 & 600 volts
 I_R @ P.I.V., 25°C — 150 nA

3 Amp Fast Recovery Rectifiers
SIN5417 & SIN5419
 T_{rr} — 150 & 250 nsec
P.I.V. — 200 & 500 volts
 I_R @ P.I.V., 25°C — 150 nA

San Francisco—941 E. Charleston, Suite 10, Palo Alto, California 94303 / (415) 328-8025

Chicago—140 N. La Grange Road, La Grange, Illinois 60525 / (312) 352-3227 / TWX: 910-683-1896

Dallas—402 Irving Bank Tower, Irving, Texas 75060 (214) 253-7644

Philadelphia—209 Chester Avenue, Room 5, Moorestown, N.J. 08057 / (609) 234-1244

New York—116-55 Queens Blvd., Forest Hills, New York 11375/(212) 263-3115/TWX: 710-582-2959

European Sales—Bourns A. G. Alpenstrasse 1, Zug, Switzerland / (042) 4 82 72/73

 **SEMTECH**
CORPORATION

652 Mitchell Road, Newbury Park, California 91320
(805) 498-2111, (213) 628-5392 / TWX: 910-336-1264

ONLY VISHAY MAKES TRIMMERS WITH ALL THESE SPECS

**lowest
temperature
coefficient** **10**
PPM/°C
(-55°C to +150°C)

**lowest
resistance
values** DOWN TO
2Ω

**lowest
dynamic
noise** **10 Ω**
ENR MAX.
THERMAL NOISE
NON-MEASURABLE

**lowest
setability
& stability** LESS THAN
.05%
"INFINITE RESOLUTION"

Vishay puts the state-of-the-art performance of its fixed resistors into trimming potentiometers! Here, for the first time is a combination of precision/stability/TC/resolution which eliminates the need for padding resistors, decreases test time, improves product performance — and YES! Vishay trimmers meet or exceed all requirements of MIL-R-27208 and/or MIL-R-22097 characteristic C. Send for your free copy of Bulletin TR-101 describing this new line of total performance trimmers.



VISHAY RESISTOR PRODUCTS

A DIVISION OF VISHAY INTERTECHNOLOGY, INC.
63 LINCOLN HIGHWAY ■ MALVERN, PA. 19355

PRECISION RESISTORS • NETWORKS • DECADE BOXES • TRIMMERS

U.S. Reports

house computer installations such as IBM 1130's or 360/25's with a single central system. Toward this end, it has already purchased 40 Burroughs 5500 computers, and now it's looking around for a vendor for 1,200 terminals, one of the largest single terminal procurements ever. Possible suppliers of the remote gear include University Computing, Univac, Honeywell, or the Control Data Corp. Each terminal in the CompuTerminal system will have a card reader, line printer, and a display.

Contracts. Proposals are due back at the Langley Research Center, Hampton, Va., by the end of April for a \$125,000 cost-plus-fixed-fee study to determine the best damage-control system for a manned space station. The one-year NASA contract covers leak detection, location, evaluation, displays, crew warning, and repair subsystems. Proposals also are due April 16 at NASA's Goddard Space Flight Center, Greenbelt, Md., for development of a prototype C-band space-flight-qualified parametric amplifier system for the space shuttle. However, because of possible changes in requirements and advances in the state of the art by the time the shuttle is ready to be launched, NASA expects that this integrated, miniaturized data-transmission system will only amount to exercise in furthering solid state techniques, and that it will never fly. NASA has made no cost appraisals for the project. As for NASA's tracking and data relay satellite, administrative problems have caused a delay in the request for proposals.

One to go. RCA's decision to separate computer hardware and software prices leaves only GE of the nine big computer makers still to make known its intentions. Even at that, RCA figured out a way to be different: it will offer the option of making a deal excluding software at a 3% price reduction, or going for the whole package at the present rate. Also, RCA is applying its plan only to its three newest machines—models 46, 60, and 61 of the Spectra 70 line.

Most engineers know ADC Products developed 82 different "Blue Chip" transformers for P.C. applications.

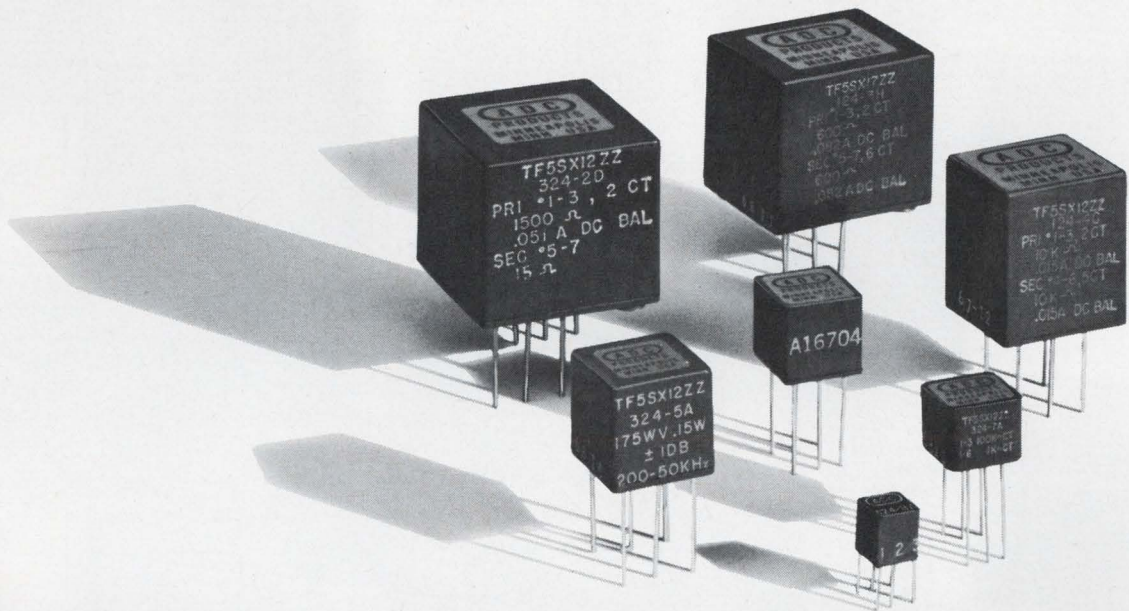

But do you know...ADC Products makes 19,897 different transformers, 3,512 different filters, 2,863 different jacks, plugs, jack panels and allied components, plus power supplies, solid state relays, pre-wired jack fields and complete communications sub-systems?

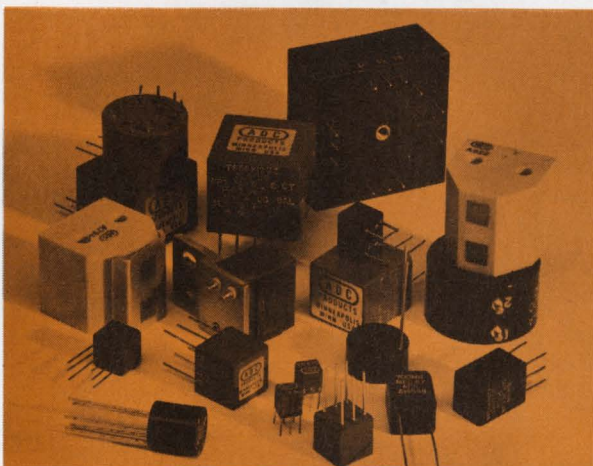

ADC not only makes hundreds of different standard products, but we also design thousands of custom devices—transformers, filters, prewired jack fields, jacks, to name but a few. We have the design staff to do it, the knowledge about your application . . . and we have a computer.

Nothing remarkable about a computer, except that we *need* it to keep track of over 26,300 custom designs already locked away. It provides us with a good starting point for optimizing your design.

This computer capability means faster service for you, higher confidence of performance in your application and just better all-around efficiency.

If you use custom iron-core components, or special components for communication applications, let ADC Products show you how computer-age technology and good old-fashioned quality can make your work easier. Write for complete information today.



ADC PRODUCTS
A DIVISION OF MAGNETIC CONTROLS CO.

4900 West 78th Street, Minneapolis, Minnesota 55435
(612) 929-7881

FRAME SIZES

CONSTRUCTION TYPES

MOUNTING STYLES

M49-FRAME
3 IN. DIA.

BOLTED STEEL
END SHIELD

END SHIELD
MOUNTING

M59-FRAME
3.4 IN. DIA.

Unitized[®]
MOTOR-STEEL
END SHIELD

SOLID BASE
MOUNTING

19 FRAME
3⁷/₈ IN. DIA.

BOLTED
ALUMINUM
END SHIELD

THROUGH
BOLT
MOUNTING

29 FRAME
4⁷/₈ IN. DIA.

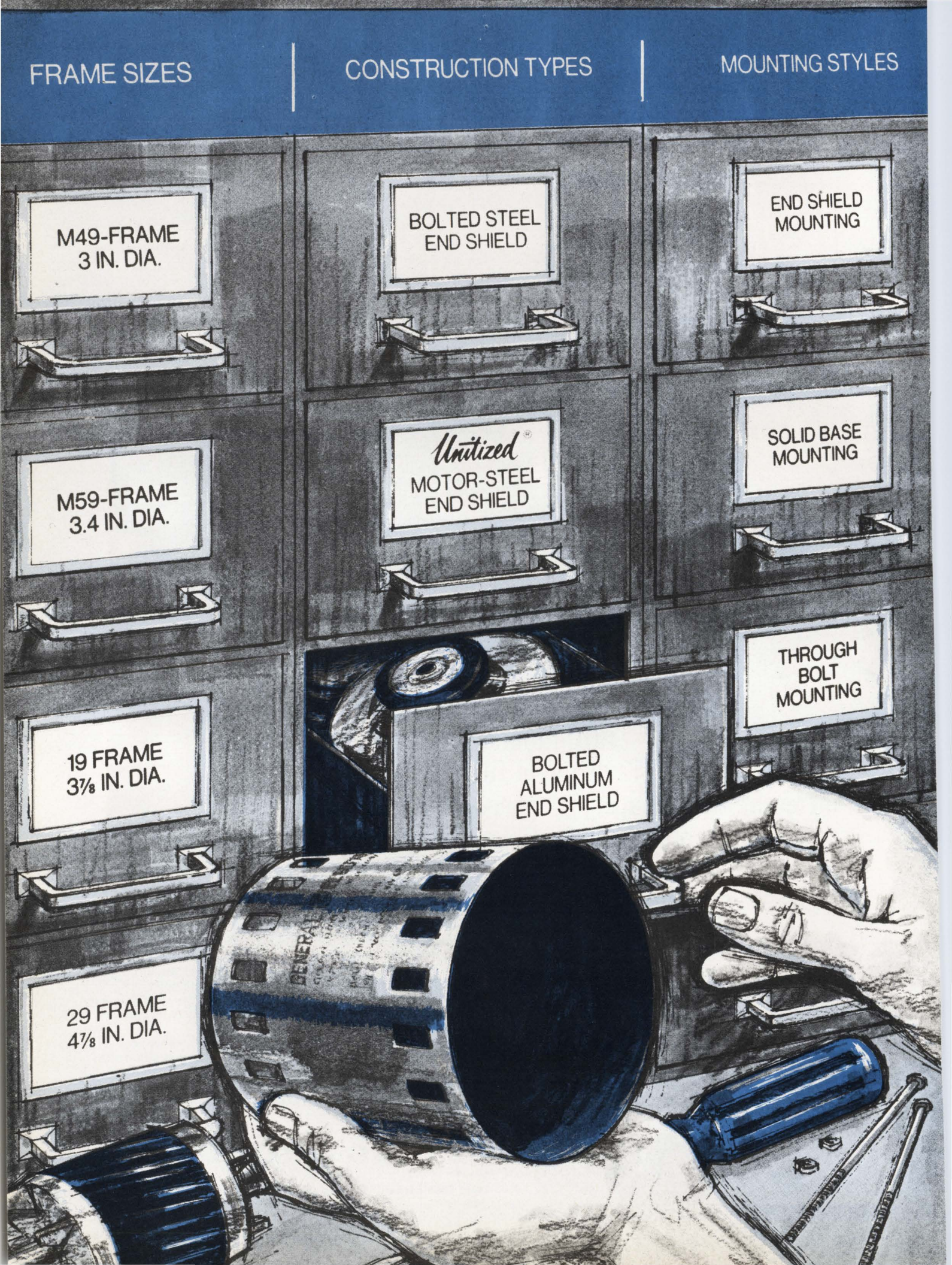

Solve your motor application problems with General Electric's versatile, "custom engineered" induction motors

Now you can combine all the application benefits of a motor specially designed to your requirements with the advantages that come with a "catalog" item.

How? By choosing the GE induction motor design features that satisfy your special electronic application needs from the many options available, such as . . .

- four different construction and mounting styles . . .
- three bearing systems...
- nine different electrical types . . .
- and four insulation systems.

The result is the versatility of design to meet your needs in a standardized motor. This custom engineering design approach means you can be sure that the GE motor you choose will be compatible with your product's design—both electrically and

mechanically. Here are just some of the choices that make this possible:

Construction types—Rigid steel shell either open or totally enclosed. Cast aluminum or steel endshields. Assembled with through-bolts or GE's patented process for manufacturing Unitized® motors. Endshield, through-bolt, solid-base or resilient-base mountings.

Bearing systems—Various sleeve or ball bearing design combinations.

Electrical types—Split-phase, capacitor start, permanent-split capacitor, shaded pole, polyphase and a complete line of reluctance-synchronous

motors. Available in single or dual rotation and instantly reversible designs.

Insulation systems—Class A, B, F and H insulating materials cover the range of temperature requirements.

Get the full story on how these reliable, versatile induction motors can help in your specific application. Call your nearby GE Electronic Components Sales Office today, or write to Section 727-27, General Electric Company, Specialty Motor Department, Fort Wayne, Indiana 46804.

P.S. Motor problems? General Electric has solutions!

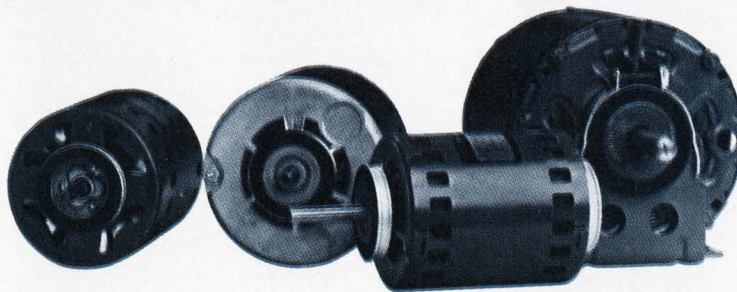

GENERAL  ELECTRIC

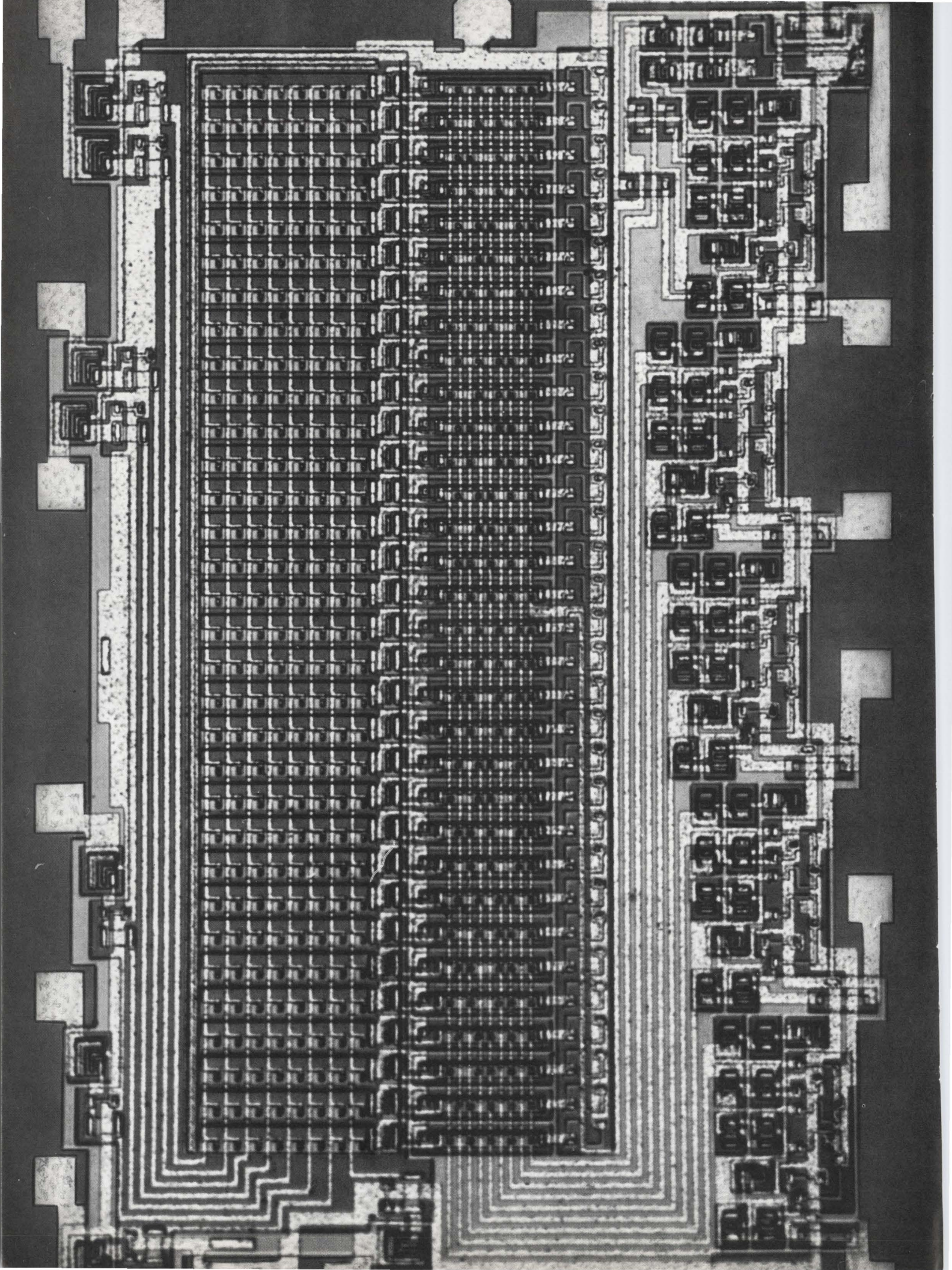

If you think Sylvania only makes pre-programmed ROMs, you haven't begun to scratch the surface.

And that's exactly what you have to do to find out how useful our SM-320 read-only memory is.

We'll sell you one of these 256-bit (32 words by 8 bits) functional arrays in its virgin state. All the outputs will be a logic "0".

All you have to do is scratch the surface of the chip, breaking the emitter connection wherever you want a logic "1" to appear at the output.

That's all there is to programming your own special data into the SM-320 ROM.

Of course, this is fine for prototyping. But, it's not what you want for quantity production.

And that's where we come in.

After you get your ROM pattern perfected, send it to us and we'll make up a special mask to match your code.

You'll have your production quantities before you know it.

The SM-320 has on-chip decoding (5 bits for 32 words) and is completely compatible with SUHL logic circuits and other TTL systems.

The next time you have an ROM problem, don't scratch your head, scratch a Sylvania SM-320. It just might get you out of a tough scrape.

Sylvania Electronic Components, Semiconductor Division, Woburn, Mass. 01801

SYLVANIA
GENERAL TELEPHONE & ELECTRONICS



MICROWAVE IC MODULES PROGRESS REPORT #10: RADAR ALTIMETER RECEIVER

When Sperry Rand's PACT (Progress in Advanced Circuit Technology) program addressed itself to radar altimeters, the objective was a receiver module on a single substrate. The objective has been achieved.

Sperry has moved out of the lab and is ready to move into the airplane with a receiver for the 4300 MHz band. It incorporates microstrip technology into a module that includes an oscillator, a switch, a mixer and a filter. The complete receiver function is packaged on a single 3" x 3" x .055" substrate.

The PACT technical development provides substantial improvement in both performance and reliability. The oscillator provides an extremely clean, low-noise input to the mixer. The oscillator-mixer combination has a double sideband noise figure of only 4 db, referenced to a 1.5 db preamplifier. Temperature range is -55 to $+100^{\circ}\text{C}$.

Reliability is greatly improved, of course, by the module's integrated, all-solid-state construction. Sperry's design replaces the customary triode oscillator and its associated reliability problems. Many other discrete components and connectors required by conventional designs have been eliminated. The new module is designed to operate under the shock, vibration and temperature conditions of the airborne environment.

The altimeter receiver again demonstrates Sperry leadership in microwave integrated modules. We would like to apply our capability to your system challenge. To help start our conversation, write or call Sperry Microwave Electronics Division, Sperry Rand Corporation, P. O. Box 4648, Clearwater, Florida 33518. (Phone 813-855-4471).

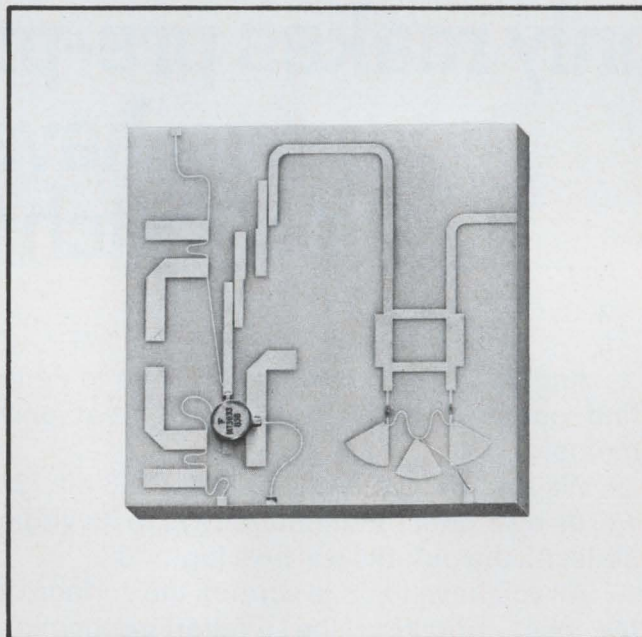

Oscillator-mixer portion of Sperry's radar altimeter receiver module (actual size).

*For faster microwave progress,
make a PACT with people
who know microwaves.*

SPERRY
MICROWAVE ELECTRONICS DIVISION
CLEARWATER, FLORIDA

International Newsletter

March 30, 1970

British growth rate to continue to 1972

An in-depth study carried out by the Electronics Economic Development Committee, an influential government-industry study group, predicts that the present growth rate of about 10% for both the British electronics market, including telecommunications, and for the output of the British electronics industry will continue at least until the end of 1972. If so, the market will grow from \$2.46 billion in 1968 to \$3.6 billion in 1972. Output will climb from \$2.56 billion to \$3.75 billion.

What's more, imports and exports, the EEDC believes, will expand at between 15% and 18% through 1972. The biggest export expansion is likely to occur in telecommunications equipment and components; while the largest import growth sector probably will be computers.

However, the EEDC sounds a warning that real improvement in trade surplus figures is not likely to materialize unless the government leans less heavily on the industry. In particular, it suggests the government should take on more responsibility for the industry's R&D expenditures, currently running at over \$250 million a year. In return, the industry would increase specialization in sectors most likely to result in improvement in the balance of trade figures, probably including computers, industrial automation, telecommunications and data transmission equipment, and microelectronics. Because of a steady reduction in government's defense expenditure, some sectors—particularly avionics—are finding it increasingly difficult to finance R&D in advanced technologies.

NASA to launch Italian satellite

Italy looks sure to orbit its own telecommunication relay satellite now that NASA has agreed to provide and launch a Thor-Delta booster. Aboard the 1972 launch will be a Sirio satellite, originally intended just for space research under ELDO supervision. But Italy decided to go it alone after complaining that it was not getting its fair share of funds. Turned into a national project, Sirio seems almost certain to receive the full funding of \$28.3 million now being discussed in the Italian parliament; of this, \$10 million will come from funds allocated for the original ELDO program.

Sirio's main mission will be to sit in stationary orbit and act as a relay station for television and telecommunications between the U.S. and Europe. A big dish being built by Telespazio near Fucino in central Italy will act as the European terminal. Sirio will also be used for research, such as testing vhf transmission from 12 to 18 gigahertz and measuring cosmic radiation, proton-energy spectrum and magnetic field.

Japanese push pcm systems

Check Fujitsu for mass-produced—hence economical—pulse-code modulation equipment. First onto the production line is a 100-megabit/second system which consists of a super-master group encoder for either one television channel or 900 voice-grade channels incorporating nine-bit linear coding. This system will have 1,440 channels. A 400-Mbit/sec system using 5,760 channels, multiplexed, is now under factory test, while an 800-Mbit/sec system using four-level coding and a 400-megahertz clock is also under test. The 100-Mbit system will be used primarily for tv coding and is expected to be field tested in another month. The pcm systems developed by Fujitsu are earmarked for Japan only, but the company says that when interest builds they will be available in the U.S.

International Newsletter

West Germany shrugs off economic cool off

The Bonn government's latest action to cool the economy—moving the bank rate up to 7.5%—will not slow West Germany's electronics industry, at least not over the short-term future. Most firms still have an order backlog to keep them busy for six months to a year. Although the rate of plant investment may fall off, demand for computers, for example, will continue unabated, with the highest increases expected for process control computers. AEG-Telefunken, which now has nearly half of the West German process computer market, feels a 50% annual increase in installations and orders can be sustained.

Japan to test fast millimeter-wave link

Field tests of a new high-speed Japanese millimeter-wave transmission system will begin in a few weeks. Recently delivered by Nippon Electric Co. to the Nippon Telegraph and Telephone Public Corp., the new equipment updates an earlier, slower system [*Electronics*, Sept. 30, 1968, p. 6E]. In that system, a 48-megahertz signal, amplitude modulated by a 225.47 Megabit/second pcm signal, was transmitted over a 4.5-mile cylindrical transmission line.

The same transmission line initially will be used in the upcoming tests, although it will be lengthened severalfold in the near future. Terminal and repeater equipment, which has already been successfully operated in the laboratory with attenuators between units, operates at a clock rate of 403.04 Mhz. Four-phase phase modulation permits transmission at double the clock rate, or 806.08 Megabits. This transmission rate is the bit stream pulse rate of a proposed higher-order pcm system.

Sweden expects surge in hardware for data networks

A promising market for modems is beginning to bloom in Sweden, according to the Swedish government's Board of Telecommunications. In five years, something on the order of 30,000 modems will be in use as the result of an on-going boom in computers and the—just beginning—expansion of data networks. Already two of the nation's largest commercial banks have started to link all their branch offices into a central network. And a consortium of banks and savings associations is planning a giant central nationwide network, called SIBOL, which will also tie in a wide number of government agencies—such as the central bank and the stock exchange—and data banks for such information as central statistics and real-estate ownership.

Right now, the Board of Telecommunications buys its modems from L M Ericsson or Standard Radio, the Swedish ITT subsidiary. However, this doesn't rule out other suppliers in the future. Currently, the board is looking for what it describes as "an inexpensive, portable model for 200 bauds."

Legal precedents to be tapped by computer in Germany

A computer soon will be used to give German lawyers and judges direct access to precedents in legal cases and to other judicial data. A Univac 418 III, to be run by Juradat GmbH, a West Berlin firm, will store in abbreviated form some 80,000 decisions and opinions of the country's supreme and state courts to help lawyers during legal processes. Juradat says the fee for a tie-in to the computer—either via teletype or telephone lines—will amount to only a fraction of the costs required for ordinary manual information searches. The computer, to be installed by the end of this year, will be operational in May 1971.

European component standards accord labeled a threat to trade by U.S.

Commerce Department fears cut in electronics exports to Western Europe; standards groups in Britain, France and West Germany call attack unreasonable

A harder line is developing within the U.S. toward trading partners in Europe and Asia, and the proposed Tripartite Accord for Electronic Components between standards groups in Britain, France and West Germany is one of the first targets of rising American anger.

Although the purpose of the pact, which is still in the planning stages, is to set mutually acceptable standards for component quality assurance and certification [*Electronics*, July 21, 1969, p. 179], U.S. government officials are viewing it as a serious threat to trade.

The dispute. What upsets Americans, says the Commerce Department's Richard O. Simpson, is that "repeated efforts to 'open' this accord to U.S. interests at this formative stage" have been "less than satisfactory." Simpson, who is deputy assistant secretary for product standards, warned the Europeans at a Geneva meeting of the United Nation's Economic Commission for Europe that "'closed' agreements on certification systems would become serious non-tariff trade barriers to those excluded."

Sensing the Nixon Administration's hard line on all trade negotiations and Commerce Secretary Maurice Stans' personal wish to maintain a positive trade balance in a vulnerable domestic economy, the Electronic Industries Association has just voted to try and kill—rather than negotiate—the accord.

The European move could cut U.S. component exports to that market, says Kenneth N. Davis, Jr., assistant commerce secretary, at the same time that Europeans are calling for repeal of the American selling price system of chemical import valuation. And protests

Davis, "We could not help but be very disappointed with the lack of interest shown by the Common Market officials when we raised this matter with them."

Paris has responded that the proposed agreement is solely designed to achieve "harmonization" of specifications. The U.S. Commerce Department and EIA think otherwise. Americans concede that the agreement will not be legislated action or even a formal agreement between governments. And they don't dispute the French argument that acceptance tests will not be mandatory. But, asks one irate U.S. export manager, "So what if the standards aren't legally binding? If they are substantively different from U.S. specifications, our products won't sell in Europe, period."

The stakes. The EIA has told the Commerce Department that incompatible standards could cut U.S. component exports "as much as 35%," according to Davis. That estimate—an extreme one—is based on total sales of components to all nations; about 35% is shipped to members of Europe's "Inner Six" and "Outer Seven" trading communities. Arguments against the accord get limited sympathy in Europe for three reasons, however.

First, EIA's own figures on total 1969 exports show good increases. Total component shipments, for example, "displayed the best annual percentage increase in the last five years," according to EIA. And Europe contributed strongly to the gains, according to the data.

The second factor—one not commonly recognized—is that U.S. producers have subsidiaries in Europe. As one industry man notes well, "Those companies are surely going

to see to the interests of their American cousins."

The third factor is the uncertain image of the EIA and the industry generally in international affairs. Even though EIA has taken a strong stand against the accord, its board of governors recently vetoed strengthening its international department by turning it into a division.

Similarly, while some individual companies are concerned about such "closed" agreements, they seldom release experts to work in international technical groups before positions are filled.

Simpson warns industry that "support for U.S. participation in international standardization work cannot be a sometime thing." He adds, "this is a fact of life that sometimes escapes American industrial and business managers."

How will industry respond to the call? The odds are not particularly good, especially in a tight domestic economy. "Unfortunately we are accustomed to reacting only to crises," sighs one American manager. "That's a fact of life, too. It's like buying life insurance or quitting cigarettes. We all know we should do it, but somehow we keep putting it off. If you put it off long enough, you're dead."

East Germany

Another link with Moscow

The East Germans have a word for it: Wissenschaftliche Systemlösung, which means "scientific system solution."

This rather vague term is fast becoming the vogue in East Ger-

man technical circles these days. Judging from the way the technocrats use it, and their obsession with it, you'd think they invented this approach to harnessing technological advances in solving engineering problems and increasing productivity.

Fair game. At this month's Leipzig Fair, East German industry officials made much ado about how this concept is implemented. As one example of a systems solution, they demonstrated how productivity can be raised by putting electronics to work in simplifying various technological steps encountered in the metal working industry.

What's involved in the example shown at the fair is a long-distance data-transmission link that spans the more than 1,600 miles between Leipzig and Moscow. That link is used to speed up both layout and production of certain complex machine parts and also to provide East German engineers with access to Russian know-how in machine design.

During the demonstrations at the fair, East German and Russian engineers pointed with considerable pride to the savings in both time and costs that their new system affords. And indeed the results are impressive. Ordinarily, they assert, it takes a designer from nine to 12 days to lay out, say, a complicated gear assembly with 40 to 50 gears and associated parts. The new system, on the other hand, cuts down that time by 95% and manufacturing costs by 40%, thanks to a new N/C machine tool.

Long distance. In detail, the system works as follows: The customer for a certain machine part enters all design parameters and dimensions that describe the part onto standard-size preprinted cards. At the Leipzig factory, the design information is punched out in coded form onto paper tape, and then processed in a terminal unit for transmission over regular telephone lines to the computer at Moscow.

At Moscow, the data is fed to a Minsk 22 computer, a medium-size machine with 16 magnetic-tape storage units. It is installed at Moscow's Research Institute for

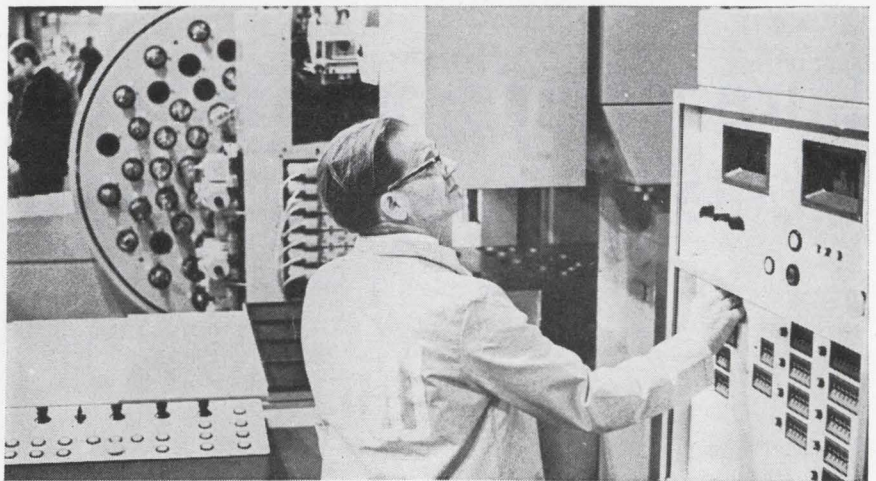

Tooling up. Operating instructions for new East German N/C machine tool are coded from data sent from Moscow over 1,600-mile link with Leipzig.

Machine Tool Design. Stored in that computer are design criteria which Soviet specialists have worked out over the years for a multitude of machine parts. The computer furnishes data for several possible design variations that best meet the original specifications. Sent back over the link to the Leipzig factory, this data is punched out on paper tape. The tape, in turns, is used to operate an automatic drawing machine, a Russian-designed Itekan 2.

Add changes. Designers at the Leipzig factory then add onto a drawing any changes that may be necessary and send these changes back to Moscow for checking. There, the computer optimizes the final design and provides data for a step-by-step manufacturing program, for a parts list and for a final assembly drawing.

The final step involves sending the manufacturing program in coded form to an East German computer at Karl-Marx-Stadt, 60 miles away. There, a Robotron 300 determines the optimum data for the N/C-controlled machine tool.

Great Britain

Taken to task

When a man is a tiny cog in a vast industrial machine, doing the same work in the same environment every day, he may not give

his best all the time. The result, if he's a creative man like a designer or development engineer, is often late delivery of the drawings or the goods, escalation of costs, or both.

The remedy, according to two management specialists with Plessey Radar Ltd., is to replace the conventional project team organized on a functional basis—all electronics men together, all mechanical men together—which tends to separate men from the object of their work, with smaller, cross-functional teams organized around specific tasks. Each man gets a psychological boost, and works better, by close association with an immediate object.

More important, if an element of competition is included by leaving open the possibility that a man can lose his place in the task team, and even that the team, in the last resort, can lose its assignment to another team, the effect is better still.

According to the Plessey man—Clem Richards, engineering manager of the Display and Data division, and Brian Ancsell, management services manager—this arrangement, plus computer assistance in network planning and cost control, has resulted in increased productivity and consistent cost savings—sometimes as much as 20% under the estimate. How Plessey Radar operates its task-team system was described by Richards and Ancsell at the Sym-

posium on Management and Economics in the Electronics Industry at Edinburgh.

Plessey Radar's work is mainly aimed at one-of-a-kind, large-scale contracts for air-traffic control and defense. Data and display systems for these projects take in a range of electronic, mechanical, and electrical engineering skills. Functional teams formed for specific projects tended to persist long after their true function had ceased because there was no compelling reason to disband them. In contrast, the task teams recruited across the specialties are given specific resources for the task at hand. When these are used up the team is without means and is forced to disband. The organization is more flexible, and communication is improved.

To form the teams, the chief engineer chooses specialist managers and a chief systems engineer to whom they report. These men sit down with the contract to work out how its commercial and technical requirements will be met. Each team manager then writes a detailed specification of his task, including "cost-to-completion" expenditure estimates and network-planning charts for use with a PERT software package. This takes about six weeks. Each manager offers his "quote" and plan of work to the management for consideration. If the management thinks it's competitive, he gets the go-ahead; if not, he has to think again, and as the last resort a new manager may be appointed. Hence, each manager is in effect a subcontractor, trying to get a contract.

Fired up. The go-ahead gives the manager the money and facilities to start work, and the authority to recruit his team from the functionally-organized labor groups in the company. The manager gets his men by giving seven days notice of his requirement to the department head; but, he cannot ask for men by name, only by grade. However, if the men are not satisfactory he can send them back to the pool and demand replacements, in the same way that a company boss can hire and fire men.

A man joins the task team when the manager wants him and stays

as long as the manager judges he can afford him, then he goes back to the pool. In the same way, when a manager's job is completed he goes back to his pool. Next time around, he may be only a team member, not a manager. Hence, the task-team system requires a background of conventional functional organization against which to operate. But, Richards says, once the system is in full swing with many task teams operating there's no significant conflict. In any case, not all the work of the company is suitable for task-team execution, and on projects where task teams are used, there's some routine work which is still best carried out by the pool. Richards estimates that at any time about 70% of manpower is in task teams.

France

Above it all

For all the masses of atmospheric data that have been pouring in from weather satellites during the past few years, meteorologists still don't know as much as they would like to know about the winds in the stratosphere. But they'll have a better idea of what's going on up there by the end of the year.

By then, France's Centre National d'Etudes Spatiales (CNES) expects to have some 350 weather balloons strung out at random in the skies over the Southern Hemisphere. The balloons will float in stratospheric winds at a constant altitude of 7.5 miles. Keeping track of them will be a special 185-pound satellite in a 562-mile high, circular orbit. On each 100-minute pass around the earth, the satellite will query each balloon and retransmit its weather data to six ground stations located in South America, the Canary Islands, Africa, and CNES headquarters near Paris. The French space agency has dubbed the project Eole, French for the Greek god of the winds.

Friable. CNES chose the Southern Hemisphere for a couple of good reasons. For one thing, the southern stratosphere is relatively

uncharted by meteorologists. For another, there is much less air traffic there than in northern skies. Even so, CNES is taking no chances: If an airplane should happen to fly into the instrument packages dangling from the balloons, the package is designed to crumble instantly.

Instant disintegration on impact, in fact, was the principal requirement laid down by CNES in its specifications for the rod-like transponder, heart of the balloon's instrument package. The transponder measures roughly 6.5 feet in length by 2.75 inches in diameter, and hangs below the balloon's sensors and solar-cell-charged batteries.

Electronique Marcel Dassault (EMD), manufacturer of the transponder, has come up with a two-stage design to give CNES what it wants. EMD is a subsidiary of Avions M. Dassault, maker of the famed Mirage fighter, and its engineers are well aware of the dangers of a high-speed aircraft hitting even a small object. The transponder is designed in two functional sections. One picks up analog information from the sensors and converts it into digital format; the other stores the data and transmits it to the satellite on demand. In both sections, ceramic substrates have been used almost exclusively. The hybrid and monolithic IC's that make up the transponder are mounted on friable plastic or phenolic paper circuit cards that fit into grooves inside a light, brittle bronze cylinder. Covers for the circuit subassemblies are made of beryllium. The assembled package weighs 2.2 pounds.

Q. and A. On station 7.5 miles above the Southern Hemisphere, the transponders will carry on an intermittent digital dialog with the satellite. Each transponder has its own address, and the satellite can contact a specific balloon in either of two ways. First, it can transmit each address in turn, stopping to listen when it receives a response. Second, it can query a given balloon on command from a ground station. The satellite collects five specific measurements from each balloon: ambient temperature, am-

bient pressure, balloon envelope overpressure, battery voltage, and the distance between satellite and balloon.

The transponder uses a super-heterodyne, phase-lock receiver with a reception passband of 1.5 kilohertz. The phase-lock feature ensures a constant coherence between received and transmitted signals, thus allowing ground stations to determine the distance from satellite to balloon by measuring doppler shift. When a transponder receives its own address and a respond order, it transmits its information to the satellite in a prescribed sequence:

▶ An unmodulated carrier signal that the satellite's receiver locks onto.

▶ Six 0 bits followed by six 1 bits used to establish the distance between satellite and balloon. Knowing this figure and the location of the satellite, ground stations can pinpoint the location of the balloon in a series of calculations.

▶ A final signal carrying sensor data.

EMD has tested three prototypes and is currently preparing for the production of the 500 transponders needed for the project. CNES plans to test the satellite in orbit for three weeks, then release the balloons at the rate of 200 per month until 350 are in the air. The remaining 150 balloons will be used as replacements. Release points for the balloons will be three bases in Argentina—32°, 36°, and 50° south latitude.

Bread and board

While working for a French data-processing equipment maker, engineer Jean Besnard spent irksome hours waiting for new logic-circuit designs to be simulated in hand-wired prototype modules. Convinced there was an easier way to simulate new circuitry, Besnard has spent the past two years developing a new integrated circuit breadboard that takes much of the drudgery out of such work.

Besnard is so sure his breadboard is a winner that he has quit

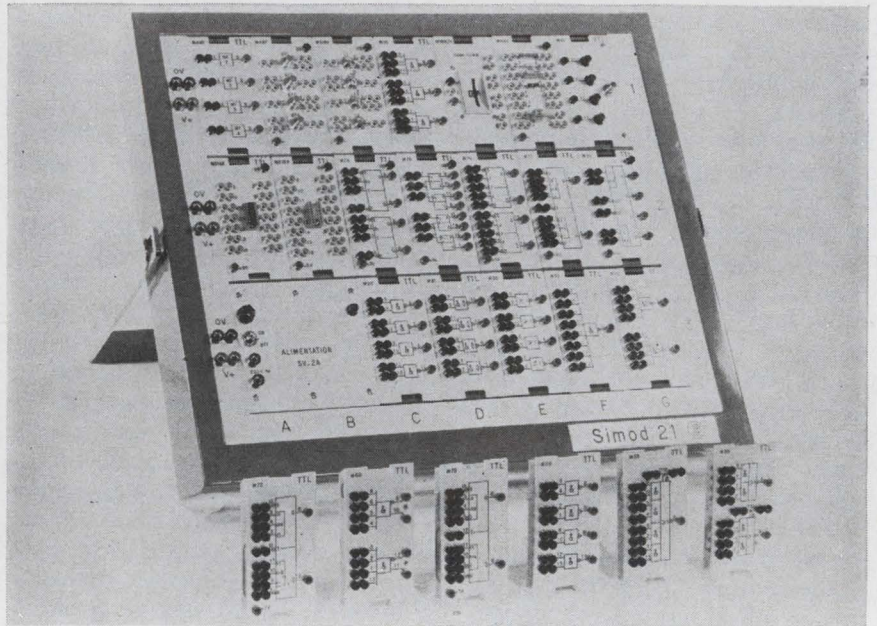

Very simulating. Integrated circuit breadboard holds modules for each different IC type. Patch cords interconnect modules and power supply.

the data-processing job and will spend full time with his father's firm, a metal-forming company called Besnard & Fils, that is now branching into the electronics business to make the breadboard.

Devices to simulate performance of new circuit designs already exist, of course, but Besnard believes his is the first, at least in France, with a modular design that lets engineers plug in different integrated circuits at will.

Debut. The new unit will be shown for the first time at the Paris Components Show, which opens this Friday for a six-day run.

So far the device can be used only with transistor-transistor logic the commonest type of IC in the data-processing industry. Modules for 15 TTL circuits are now available. The face of each module measures 2.5 by 5 inches. They are arrayed in rows in an easel-like box, that also includes modules for power supply and push-button circuit testing.

Users buy modules corresponding to a particular type of IC, which the user must supply. They insert on the hidden back side of the module an IC of virtually any major manufacturer corresponding to the module's IC type. Being able to use any brand of IC is important, says Besnard, because of slight per-

formance differences that inevitably exist between brands.

A printed-circuit board connects the IC's pins to female plugs on the module's display surface. Two plugs per pin allow multiple coupling. Symbols beside each plug indicate the corresponding pin and its function. Connecting the pins by means of jump cables to each other and to the unit's power supply and control boxes lets the designer test voltage output.

Four push-buttons and four toggle switches enable zero to 5 volt electrical pulses—cleaned up by a filter and trigger circuit—to pass through the circuit being tested. A red light corresponding to each switch glows to indicate 0 or 1 logic voltage levels in the TTL circuits.

Neatness counts. If interest shown at the Paris Show warrants it—and if different manufacturers' circuit types begin to fall more into neat categories as they do in TTL—Besnard plans to start offering MOS modules in three to six months.

The basic box for the 21-module unit will cost \$285. TTL modules will sell for from \$21.50 to \$39, depending on complexity. Power supply, including transformer, filter circuit and IC voltage regulator, will cost \$90.

Washington Newsletter

March 30, 1970

Page chief leads for communications job

Joseph A. Waldschmitt, president of Page Communications Engineers, is the leading candidate for the top communications job at the Pentagon [*Electronics*, March 2, p. 77]. Waldschmitt, also a vice president of Page's parent company, Northrop Corp., would be assistant to the Secretary of Defense (Communications). Insiders say selection is proceeding slowly, however, and that other candidates are by no means out of contention. Among them are Secretary Laird's top staff man for the National Communications System, David Solomon; White House aide Ken Belieu; AT&T's T.W. Scandlyn and Benjamin Oliver; Hewlett Packard's Bernard Oliver; Bell Labs' John R. Pierce; the Red Cross's Adm. B.F. Roeder; and the Air Force's John W. Perry, deputy for communications in the Installation and Logistics office.

IBM to seek patent on 'eye-safe' laser

The International Business Machines Corp. is preparing a patent application for a laser operating in the 1.54-micron region and specified by the Army surgeon general as "eye-safe." Pending the filing, the laser devices group headed by James T. Vanderslice at Federal Systems division, Gaithersburg, Md., will say only that breadboard models are operating, the laser has the lightweight characteristics needed for range-finding applications, and it produces an output of about 1% from an input "on the order of 100 joules." IBM says its in-house effort cracked the problem of developing a transmitter source in the 1.5 μ -region "that was light enough and efficient enough for range-finder applications."

Strapdown guidance eyed for shuttle

Strapdown inertial guidance is being studied for the space shuttle by several companies including AC Electronics, a member of the Boeing-Lockheed team; Honeywell, teamed with North American Rockwell; and Hamilton Standard, which is not yet committed to a bid team. Thus far, the only use of strapdown on manned spacecraft was Hamilton Standard's backup system on the lunar module. Proponents claim strapdown has cost, weight, and reliability advantages over gimbaled designs. Cost may be decisive throughout the program. With this in mind, Lockheed is making a detailed study of available avionics, hoping apparently to use off-the-shelf equipment wherever possible.

Boeing and Lockheed—if they get one of the contracts—would also like to look at the tradeoffs of a different launch-landing plan for the shuttle booster. This team thinks it might be less costly to launch from one base, and have the booster glide to a landing perhaps a thousand miles away. Originally it was thought the noise and risk of flying over populated areas would require use of one isolated base.

Comsat's role as Intelsat manager safe for eight years

Communications Satellite Corp.'s role as technical manager of the International Telecommunications Satellite Consortium will continue for about eight more years with tentative acceptance of a compromise agreement by member nations after a five-week meeting in Washington [*Electronics*, March 16, p. 62]. U.S. officials say privately that the compromise, accepted in principle by most Intelsat countries before adjournment, is better from Comsat's viewpoint than was expected. European nations had been demanding an end to Comsat's management. The com-

Washington Newsletter

promise gives Comsat a six-year contract, effective from the date of the permanent agreement. This is expected to take 18 to 24 months to work out in detail.

FCC expecting flood of comments on satellite policy

The FCC is getting ready to receive a flood of comments on its domestic communications satellite policy, one which closely parallels the White House recommendation [*Electronics*, Feb. 2, p. 125]. FCC's "notice of proposed rulemaking" is expected sometime in April following a vote which favored 5 to 2 the plan to open up U. S. space communications to anyone with the money and a technically acceptable satellite system proposal. Expressing opposition to the plan during a closed meeting were commissioners Robert E. Lee, conservative Republican, and Kenneth Cox, a liberal Democrat whose term expires June 30.

DOT to fund work on linear induction

Large linear-induction motors—quiet and pollution-free—for high-speed ground transport will get fresh Department of Transportation money in April with the award of a multimillion-dollar demonstration project scheduled for operation by 1972. Los Angeles, Kansas City, and Washington are lead cities for the commuter project which calls for a 150- to 200-mile-per-hour tracked air-cushion vehicle. If Transportation boss John A. Volpe has his way, the demonstration project will be based on existing technology.

NASA budget boost has dim future

Expect the \$298.5 million manned space-flight addition to the NASA budget to receive stiff opposition March 31 when the bill reaches the House floor. The Republican Policy Committee has said it will support only the Administration's \$3.333 billion figure, and some Congressmen have stated they will fight the increase.

Joseph E. Karth (D., Minn.) wants to cut not only the \$80 million added for extra engineering studies and advanced-prototype efforts for the space shuttle, but also the \$110 million already in the budget for the shuttle and station. Edward I. Koch (D-Lib., N. Y.) will push to eliminate all station-shuttle funds, plus the \$145 million added for the Apollo program, the existing \$35 million allocated for Viking, and \$38 million planned for the Nerva nuclear rocket engine. The slashes proposed by Karth and Koch are not expected to get decisive support.

NASA planning personnel are still unsure exactly how the proposed extra dollars might be spent—probably because the agency isn't making "any great plans based on receiving any more money," one high NASA official explained. Industry isn't optimistic, either.

Addenda

Ion engines are getting a new source of support after years of effort by NASA. Intelsat is funding a year's research at TRW Systems for an improved engine design for large orbiting spacecraft. The funding level is still low, however. Intelsat's manager, the Communications Satellite Corp., has given TRW only \$40,000. . . . Watch for Commerce Secretary Maurice Stans to call U.S. industry leaders to Washington soon to plan an all-out drive on unfair restrictions by other nations. The proposal suggests Stans is listening to Motorola's Robert Galvin and others calling for more Government-industry cooperation, like that in Japan, to crack foreign markets.

Take advantage of RCA's ability to supply superior SCR's and Triacs... when you need them.

Ask our solid-state specialists why RCA's broad line of industrial SCR's and triacs excel in quality, reliability, and performance. They'll tell you that RCA thyristors are subjected to some of the toughest quality assurance tests in the industry. Thus, they save design dollars by virtue of superior performance in critical applications.

Ask users of industrial thyristors why RCA is a key supplier and they'll tell you RCA services the industry! Whatever the application—area lighting to avionics, regulators to inverters, or power supplies to modulators—RCA has SCR's and triacs to meet your application requirements.

Use these SCR's and triacs in your control applications:

SCR Family	Rating		Triac Family	Rating	
	$I_{T(RMS)}$	V_{DROM}		$I_{T(RMS)}$	V_{DROM}
40740	10 A	600 V	2N5568	10 A	400 V
40752	20 A	600 V	2N5572	15 A	400 V
2N690	25 A	600 V	40671	30 A	600 V
2N3899	35 A	600 V	2N5543	40 A	600 V

NOTE: SCR ratings of 100, 200, & 400 volts and triac ratings of 200 & 400 volts are available in each family. Stud packages & isolated-stud packages are also available in each rating.

For further details and your copy of the latest thyristor catalog, THC-500, see your local RCA Representative or your RCA Distributor. Or write RCA Electronic Components, Commercial Engineering, Section RN3-2/UR6, Harrison, N. J. 07029. In Europe: RCA International Marketing S.A., 2-4 rue du Lièvre, 1227 Geneva, Switzerland.

RCA
Thyristors

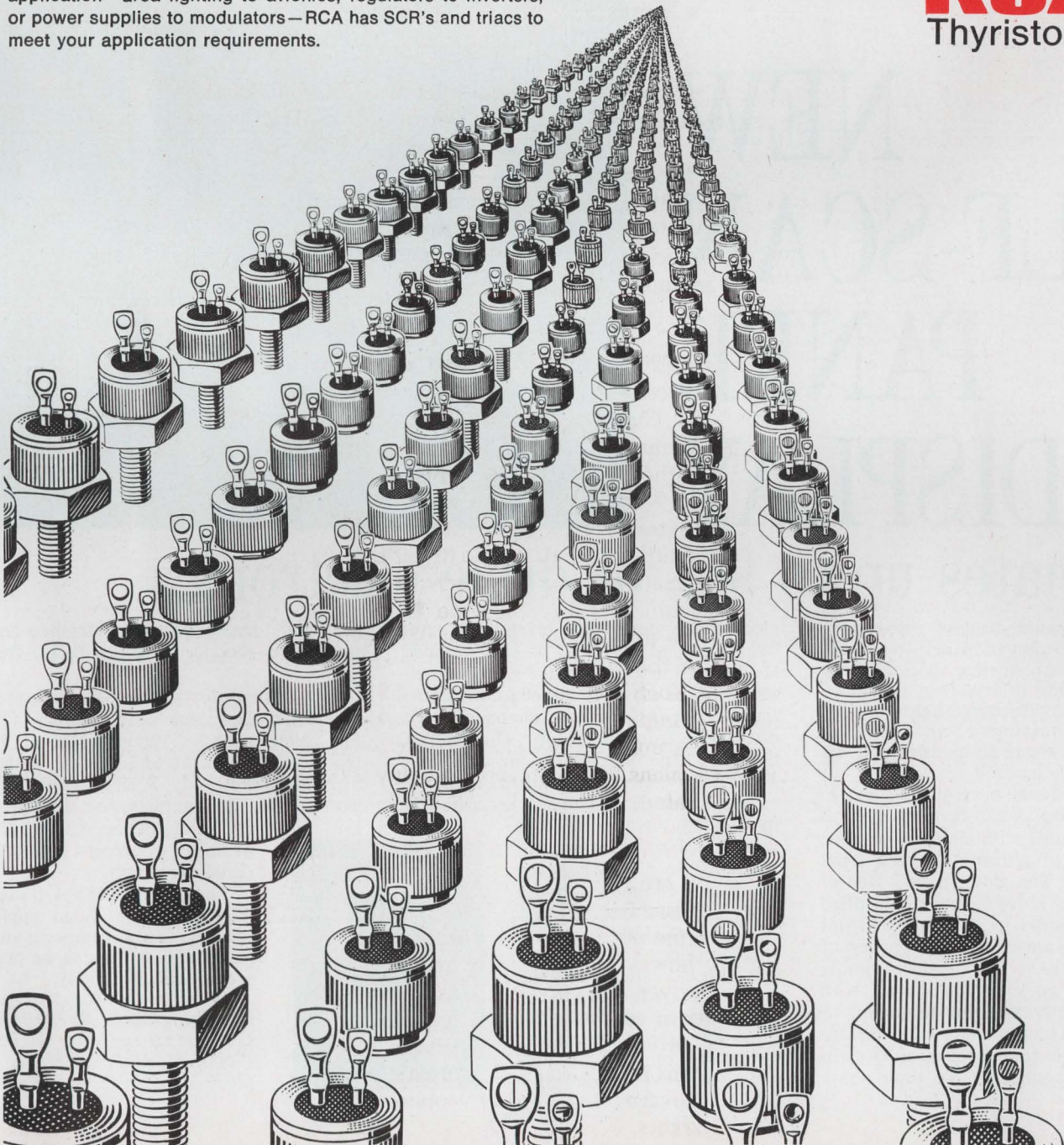

NEW SELF-SCAN™ PANEL DISPLAY

eliminates up to 90% of drive electronics

SELF-SCAN panel displays represent a Burroughs invention of panel design and circuitry that permits time sharing of the cathode electrode drivers in a flat panel display using gas discharge light emitters. Consequently a savings of up to 90% of the electronics required to drive the dot matrix display is realized.

For informational purposes the SELF-SCAN panel display can be thought of as a dot matrix panel with common cathode strips capable of glowing on both front and back sides. The glow on each side of the cathodes is independently controlled by a set of anodes located on the front and back of the panel. The rear portion of the display consists of 7 glow-priming anodes which work in conjunction with 111 vertical cathode strips (common to both sets of anodes). These cathodes are interconnected in three groups of 37 cathodes each and connected to a three phase

clock which sequentially brings each cathode to ground potential. As each cathode is grounded in sequence, the glow is transferred to the adjacent cathode. This transferred glow at the rear of the panel is not discernible from the front. (The illustration shows the first cathode grounded and glow at the 7 rear anode intersections.)

When it is desired to display a dot on the viewing surface, the front glow transfer anodes are utilized. (The glow transfer anodes and common cathodes make up the front matrix.) The appropriate transfer-anode is selected in synchronism with the cathode and the glow transfers forward to the panel front for viewing. (The illustration shows the top and center dots on the first cathode transferred for viewing.)

The whole display panel is refreshed and updated to produce a bright flicker-free display.

As a normal dot matrix panel requires a cathode driver for each cathode (80 high-voltage drivers required for a 16 digit display) and the SELF-SCAN panel display requires *only* 3 clock controlled cathode drivers regardless of the number of digits, the significance of this development is immediately apparent.

The SELF-SCAN panel display has unlimited applications, as alphanumeric and graphic messages can be presented with simplicity.

Write today for descriptive brochure, Burroughs Corporation, Box 1226, Plainfield, N. J. 07061. (201) 757-3400.

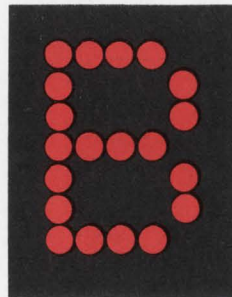
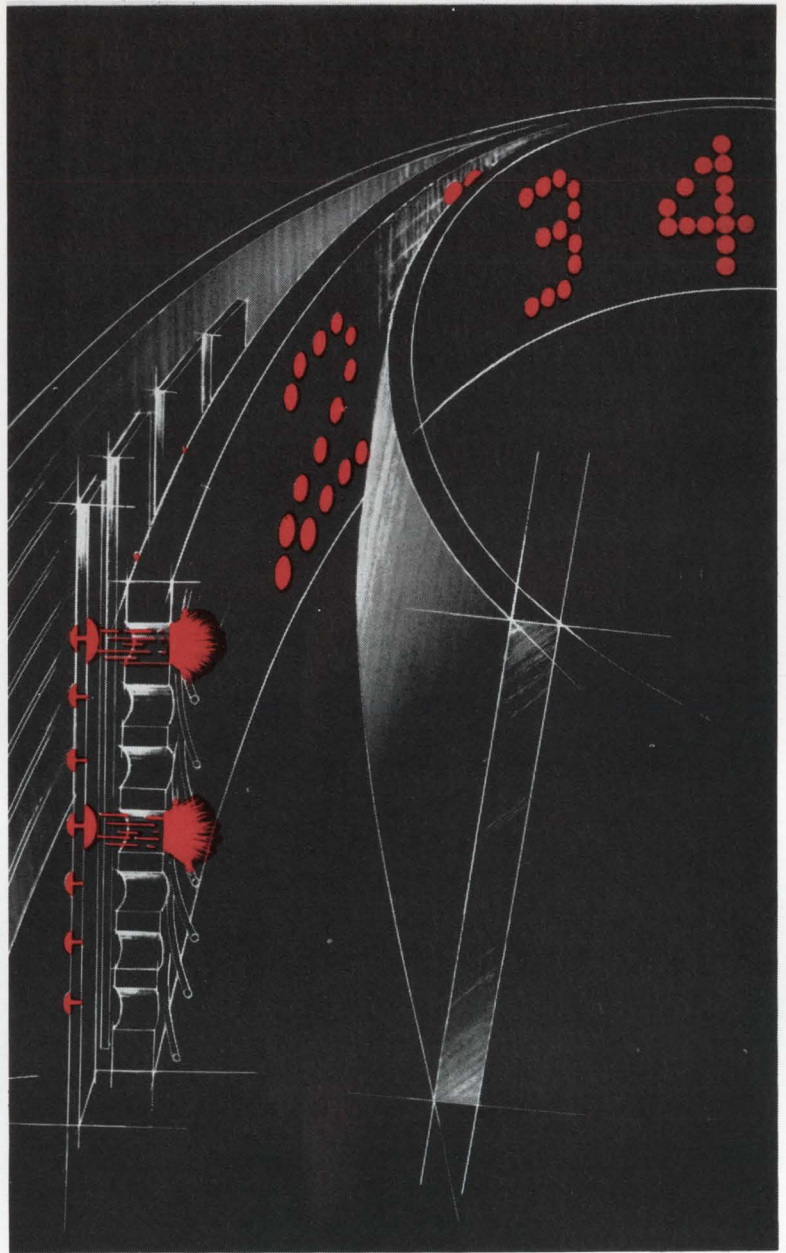

Technical Articles

**Product planning
is more than
getting new ideas**
page 86

Design engineers to an increasing extent are being asked to actively participate in deciding which new products their companies should make. This role depends on many factors, but the essential component is the need to work smoothly with other groups within the company, such as research, marketing, and manufacturing.

**You don't have to
go to far to find
a CAD program**
page 98

Early computer-aided design programs, while a major step forward, still left plenty of room for improvement. Now a second generation of computer programs has evolved, but all programs rely on circuit models. This article rounds up both the advantages and disadvantages of available computer programs and their models.

**TOPS opens up new
route to reliability**
page 108

The unmanned spacecraft that makes the "Grand Tour" of the outer planets will have to insure long life and adaptability for a mission lasting eight to 12 years. TOPS, for thermoelectric outer planet spacecraft, being developed at the Jet Propulsion Laboratory, could affect the design of all future unmanned space probes.

**Synchro-to-digital
converters: Pick one
that fits your needs**
page 116

Tracking synchro-to-digital and resolver-to-digital converters continuously update their output, are highly accurate and are nearly immune to noise and harmonics, but are expensive. Sampling units update every 1.25 msec, can't cope with harmonics and noise, and aren't as accurate, but are less expensive. The right one for you depends on your needs.

**The broken promise
of LSI: Packaging**
page 123



Although sales and development of large-scale integrated circuits have been accelerating, packaging problems—high costs, low yields, defects, and slow deliveries—could put a serious crimp in the projected fast growth of the technology. Caught in the middle of a severe squeeze, manufacturers of LSI, particularly the MOS segment, are beginning to design their own packages,

aiming for higher levels of integration in the process, and lower packaging costs.

**Millimeter-wave
communications**

Coming

With future demand from all sources expected to put a strain on long-distance communication lines, Bell System is working on a proposed millimeter wave system, using waveguides as the transmission line network. Key to the system is the source of millimeter waves that will make it a reality.

There's more to product planning

Planners have to blend the skills of both engineering and marketing much less move ahead; the trend appears to be toward teamwork,

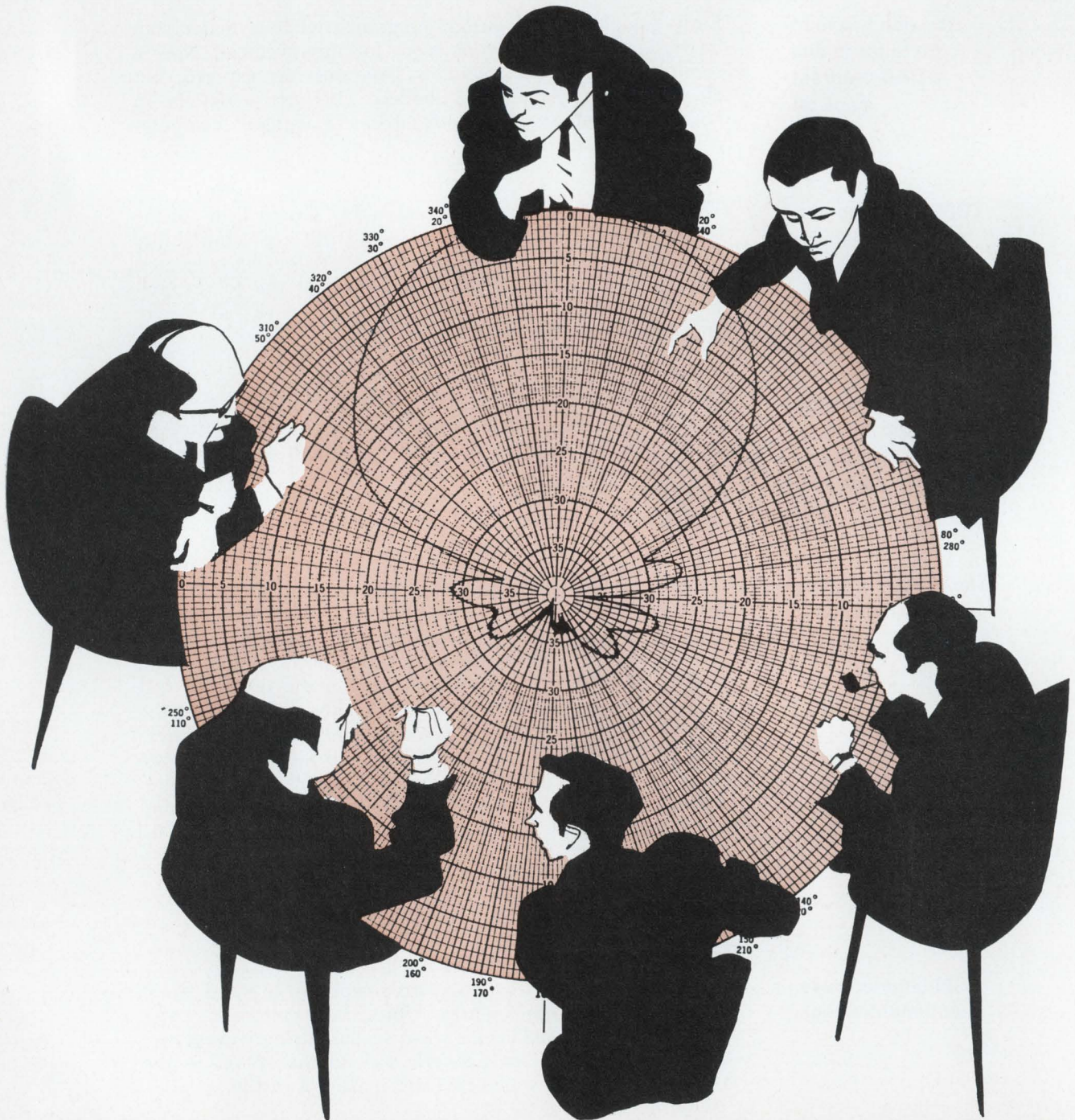

than the generation of new ideas

if they want their companies to keep pace with their competitors, with the technologist playing a larger role in the decision making

● Product planning, whose job is it? Technologist's? Marketing executive's? Take your pick, but don't wager on being right. For product planning, as practiced by most electronics companies, is the job of both the technologist and marketing executive or, at least, someone who combines the knowledge, if not skills, of both. Unquestionably, today's technologist is finding himself playing an ever-increasing role in product planning. As a member of the "product-planning team," the technologist must now cope with factors as diverse as evaluating the market potential of new products, gauging how the products fit into his company's capabilities, knowing his company's financial posture as well as that of the economy in general, and understanding his customers' needs. But overall, the technologist's primary responsibility in product planning is still the origination of ideas.

Most companies credit their own people—their engineers and scientists—as the idea men. The greater the new technology content of a product, it seems, the more likely it is that engineers within the company will originate the idea. Other frequently mentioned idea sources are customers, planning committees, fulltime specialized planners, outside consultants, and various combinations of these. These sources tend to be associated with ideas involving less advanced technology.

The views of George Smith of Beckman Instruments Inc. typify those of the company-people-dependent firms. Smith is director of research and development for the microcircuits operation of the Helipot division in Fullerton, Calif. "Ideas for radical departures from standard products generally come from technical people, and most of our managers have technical backgrounds," he says. On the other hand, he finds that ideas for variations on standard products come mostly from customers and the company's marketing people.

Stated another way, companies tend to depend on their own experts for revolutionary product ideas. Texas Instruments' Optoelectronics group in Dallas, for example, strongly encourages innovative thought among its technical specialists. Ed Youch and Ken Morton, market strategists through whom much of the Optoelectronics group's planning ideas funnel, are strongly aware of their need for ideas originated by technical specialists. The primary responsibility of a product

planner is to recognize the revolutionary product change, to "grab the new idea and make the market," in Youch's words.

Many companies have established communication channels to encourage the flow of ideas from engineering people to the market planners. At the Cimron division of Lear Siegler Inc., in San Diego, Calif., product planning follows an informal system. Anybody at any time can put forth an idea by submitting a four-part checklist, which contains marketing, engineering, manufacturing, and financial information. Then other departments are brought into the act. The proposal is reviewed by a staff consisting of the president, the controller, and managers from marketing, quality assurance, manufacturing, and any others thought necessary. According to Cimron's president John Cope, this system avoids the problems that crop up when a single group—marketing, engineering, or whatever—dominates the planning. Marketing, for instance, might want to match the competition regardless of market size; engineering sometimes tends to be too blue sky. All groups should be represented to provide checks and balances.

Sanders Associates Inc. of Nashua, N.H., too, tries to make it easy for engineers to submit ideas. Thomas Culligan, corporate manager of market research and and planning, states that the company president, Royden Sanders, has a policy of fostering individual creativity as long as it's consistent with good business practice. Toward this end, Sanders "allows anyone with a good idea to come to him; almost anyone can come right in." Then, after Sanders gets to the core of the idea—"wings the technical mystery out of people," as Culligan puts it—he sends them to the R&D office, which helps them to put in writing the information needed to plan a development program and satisfy patent department requirements.

In contrast, many companies rely on committees to generate new-product ideas. Brainstorming committees are common. For example, at Electronic Communications Inc., a division of National Cash Register in St. Petersburg, Fla., product planning begins with a yearly brainstorming meeting "at which we ask ourselves 'What should we be doing?'" reports Joseph Mensch, director of systems engineering at ECI. Each division leader advocates his own particular plans, which may or may not result in company funding. "Appropriate

Input-output forecasts reconnoiter the market

Although the input-output technique is an extremely powerful tool in economic forecasting (and hence in product planning), it has a serious drawback: It needs up-to-the-minute data, and plenty of it. The U.S. Government is a major supplier of input-output data, but while the Government's data is comprehensive, it's no more recent than the latest Government census of industrial activity. Such censuses have been made in 1958, 1963, and 1968, for example.

In a dynamic industry like electronics, this is too great an interval. However, one company, Quantum Science Corp., a New York-based firm specializing in electronic technology and marketing, is now providing detailed five-year input-output forecasts with annual updating of the data base. Quantum furnishes its clients with input-output charts and tables from which it's possible to extract answers to the following questions:

- ▶ What are the end markets for products?
- ▶ How big are each of these markets and how fast are they growing?
- ▶ What are the markets, their sizes and growth rates, for other related products the client might consider producing?

Quantum Science answers these questions in amazing detail by slicing its data-base cake in a variety of ways. The end-market equipment categories of population-oriented electronics, information and communication systems, instrumentation, etc., are subdivided into specific equipment—high-speed computer line printer, high-fidelity receiver, five-decade digital voltmeter are examples. For each of these equipment categories and subdivisions, Quantum can furnish the unit and dollar volume of every component the equipment needs over the next five years. For the components, too, the classifications are broken down into minute detail—medium-array metal oxide semiconductor register, high-power video transistor, film-dielectric nonmetal-case capacitor, for example.

To understand how this mass of detailed data can be used, consider the case of a hypothetical capacitor manufacturer, Capcorp, which finds that its sales of ceramic capacitors have been dwindling. The company examines Quantum's charts for capacitors and finds that the trend can be expected to continue for at least the next five years.

The solution, then, is for Capcorp to find markets for another type of capacitor—a new product. Capcorp now examines the Quantum charts to find the distribution of capacitor sales among the various user markets over the next five years. This will reveal those end uses that will have large requirements for capacitors. Capcorp finds that these are color tv and digital-computer central-processing units.

Capcorp rejects color tv as a potential market. The consumption of capacitors by that industry is very large indeed—the trouble is that it's too large. It's dominated, as the data shows, by a few extremely large capacitor suppliers, and there is severe price competition.

The CPU's are another story. Although smaller than that for tv, the market is still sizable and no suppliers have a corner on the market.

Next question: What kinds of capacitors will CPU's require? Back to the charts, this time for a rundown of each of the components in a CPU, where Capcorp finds such items as electrolytic aluminum capacitors, electrolytic tantalum-foil capacitors, and mica capacitors listed, with total dollars and units given for each type for each year through 1974. Capcorp quickly discovers that large-can aluminum electrolytic capacitors are needed in large quantities in CPU's and the need grows steadily each year. Moreover, the total dollar volume reveals that, although unit price will decrease somewhat, the total dollars will grow steadily too. The company accordingly plans to introduce a line of new aluminum capacitors.

Even with this decision made, there's still more information to be gotten from Quantum's data. Quantum identifies all companies manufacturing CPU's and the estimated use of tantalum capacitors by each. Capcorp can therefore concentrate its sales efforts on those companies that can give it the most business. It can even assign sales quotas to individual salesmen from this data.

Quantum gets its data from bills of materials for products, both existing products and future ones "designed" by Quantum's engineering staff, combined with estimated production rates. Quantum is aiming for a typical forecast error of about 10%, according to Mirek Stevenson, the company's president.

EQUIPMENT TECHNOLOGY ANALYSIS						
COMPUTER EQUIPMENT DIGITAL CPU	6		\$ - TOTAL SALES IN MILLIONS			
	6	1	QTY - TOTAL QUANTITY IN MILLIONS COEF. - DIRECT I-O COEFF. IN PERCENT			

* EQUIPMENT CATEGORIES	* 1968	* 1969	* 1970	* 1971	* 1972	* 1973

* PASSIVE COMPONENTS	*	*	*	*	*	*
* CAPACITOR	*	*	*	*	*	*
* PAPER DIELECTRIC	*	*	*	*	*	*
* METAL CASE	\$	\$	\$	\$	\$	\$
29 1 1 1	QTY * .208	.233	.275	.332	.389	.446
	QTY * .138	.160	.194	.242	.292	.342
	PRICE/COEF * .010	.009	.009	.009	.009	.009
* NON-METAL CASE	\$	\$	\$	\$	\$	\$
29 1 1 2	QTY * .000	.000	.000	.001	.001	.001
	QTY * 2.376 T.	3.251 T.	4.408 T.	6.076 T.	7.928 T.	10.000 T.
	PRICE/COEF * .000	.000	.000	.000	.000	.000
* FILM DIELECTRIC	\$	\$	\$	\$	\$	\$
* NON-METAL CASE	\$	\$	\$	\$	\$	\$
29 1 2 2	QTY * 1.874	2.402	3.128	4.189	5.193	6.250
	PRICE/COEF * .011	.012	.013	.014	.015	.016
* PASSIVE COMPONENTS	*	*	*	*	*	*
* CAPACITOR	*	*	*	*	*	*
* ALUMINUM ELECTROLYTIC	\$	\$	\$	\$	\$	\$
29 1 5 0	QTY * 1.485	1.843	2.391	3.164	3.951	4.750
	QTY * .781	1.108	1.585	2.276	2.975	3.675
	PRICE/COEF * .071	.075	.080	.087	.093	.099
* METAL CASE, TUBULAR	\$	\$	\$	\$	\$	\$
29 1 5 1	QTY * .099	.152	.218	.311	.411	.511
	QTY * .298	.502	.792	1.218	1.653	2.088
	PRICE/COEF * .005	.006	.007	.009	.010	.011
* LARGE CAN STYLE	\$	\$	\$	\$	\$	\$
29 1 5 4	QTY * 1.382	1.685	2.165	2.845	3.531	4.218
	QTY * .479	.600	.787	1.051	1.315	1.579
	PRICE/COEF * .066	.068	.073	.078	.083	.088

COMPONENT MARKET ANALYSIS						
PASSIVE COMPONENTS CAPACITOR ALUMINUM ELECTROLYTIC METAL CASE, TUBULAR	29 1		\$ - TOTAL SALES IN MILLIONS			
	5	1	QTY - TOTAL QUANTITY IN MILLIONS COEF. - DIRECT I-O COEFF. IN PERCENT			

* EQUIPMENT CATEGORIES	* 1968	* 1969	* 1970	* 1971	* 1972	* 1973

* COMMUNICATION	\$	\$	\$	\$	\$	\$
* CLOSED CIRCUIT	\$	\$	\$	\$	\$	\$
8 5 0 0	QTY * 2.046	2.140	2.268	2.378	2.612	2.846
	QTY * 9.119	10.081	11.264	12.634	14.837	16.837
	PRICE/COEF * .736	.673	.619	.571	.540	.510
* COMMUNICATION	\$	\$	\$	\$	\$	\$
* CLOSED CIRCUIT	\$	\$	\$	\$	\$	\$
* INTERCOM	\$	\$	\$	\$	\$	\$
8 5 1 0	QTY * 1.118	1.136	1.145	1.144	1.128	1.128
	QTY * 5.205	5.579	5.933	6.252	6.497	6.742
	PRICE/COEF * .648	.590	.540	.497	.457	.417
* HOME	\$	\$	\$	\$	\$	\$
8 5 1 1	QTY * .594	.579	.562	.546	.526	.506
	QTY * 2.611	2.677	2.736	2.798	2.838	2.878
	PRICE/COEF * 1.149	1.050	.957	.873	.796	.719
* COMMERCIAL	\$	\$	\$	\$	\$	\$
8 5 1 2	QTY * .524	.557	.583	.598	.602	.602
	QTY * 2.594	2.902	3.197	3.454	3.659	3.864
	PRICE/COEF * .435	.407	.381	.357	.334	.310
* COMMUNICATION	\$	\$	\$	\$	\$	\$
* CLOSED CIRCUIT	\$	\$	\$	\$	\$	\$
* PUBLIC ADDRESS	\$	\$	\$	\$	\$	\$
8 5 2 0	QTY * .363	.372	.381	.390	.400	.410
	QTY * 1.471	1.587	1.713	1.847	1.993	2.139
	PRICE/COEF * 1.496	1.404	1.322	1.242	1.163	1.084
* FIXED	\$	\$	\$	\$	\$	\$
8 5 2 1	QTY * .339	.348	.357	.366	.376	.386
	QTY * 1.393	1.504	1.626	1.755	1.896	2.047

internal negotiations precede any funding by the company," says Mensch. "There is no formal, structured market planning at ECI," he says. "We use serendipity and old-fashioned gut feelings. When a leader feels he's right, he fights for it."

Radiation Inc., a subsidiary of Harris Intertype, says that its Microelectronics division based in Melbourne, Fla. also approaches product planning with a form of brainstorming. A group of individuals from advanced marketing and from research look at products for a broad market and come up with what they consider saleable items. Whether they can be built is decided later, when the engineering department examines cost, reliability, and fabrication problems. Finally, there is a concept review, at which final approval or disapproval is made.

Extremely large, highly structured companies firmly endorse the committee approach to product planning, but their planners tend to shudder at the casual manner exemplified by ECI and Radiation Microelectronics. Lincoln Hayes, director of corporate planning for Ling-Temco-Vought of Dallas, puts it this way: "At LTV we organize for new products." The vehicle for this organization is a new-business committee, the director of which must answer to stockholders. At its regular monthly meetings, ideas are presented from various divisions, the committee discusses them, and makes plans for developing those that seem attractive after market analysis.

"We don't use the suggestion-box approach," Hayes says. "Line supervisors get the ideas from the people in their departments and bring their plans to the committee."

Most companies agree that product planning is most effective when it's organized to some extent, with definite responsibility fixed and with definite review loops established. Not all, however. One, Roger Cady, manager of small computer engineering for the Digital Equipment Corp. of Maynard, Mass., feels strongly that the function is best done in his company on an informal basis. "We have no definite product planning function," he says. "This is partly because we want to put a large amount of responsibility onto each engineer. The engineer is responsible all the way through. Only about 20% of his time is engaged in pure engineering, and 80% is given over to coordination." He is not

allowed to place any blame on other groups, such as manufacturing. In Cady's view, this policy draws the engineer closer to the project: "The engineer's identification with his product is impossible if he is just given a set of specs to work on and if he cannot contribute new ideas."

TI's Ed Youch points out a weakness in the highly organized, corporate-committee approach to product planning in which ideas must filter up through the chain of command in order to gain attention. "What happens if the first-line supervisors aren't so smart? Since they must filter out 49 of the 50 ideas presented to them, what happens to the other 49?"

But in the contrary view, formal planning committees are essential to weed out well-meaning but impractical suggestions from engineers. Since planning committees are not involved in personal pet projects, they can be objective and hard-headed, and plan products that stockholders can make money on.

The trend, nevertheless, is to encourage the contributions of individual engineers to planning, even when ideas are scrutinized and passed on by a committee. "Product-planning committees are a necessary evil," says W. Donald Bell, vice president of marketing at Silicon General Inc. of Westminster, Calif., "but they aren't the thing that creates new products and identifies new ideas."

When a new product is more evolutionary than revolutionary, customers play a far bigger part than they would otherwise. The company's engineers and salesmen act more as go-betweens than as originators. For market feedback on its evolutionary products, Beckman's microcircuit operation uses a computer to analyze sales and inquiries on standard products. The company then contacts the customers to find out how a part was used in the system and how they liked the product. "And we listen to their complaints," says R&D director George Smith. "This provides significant input to standard products lines that are developing."

Often, in the generation of evolutionary product ideas, the go-between role is a crucial one. The Digital Equipment Corp., for example, regards its field engineers as a primary source of product ideas; they generate ideas based not only on what the customers want, but also on what the competition is doing.

Not every manufacturer believes that employee participation in product planning through customer contact is a good thing; some feel that dealing with the customer will distort the engineer's viewpoint. Jack Margolis, product-planning manager for Sanders Associates' Data Systems division of Nashua N.H., believes a dangerous situation could arise if engineers are in close communication with customers—they may identify too closely with the customer. "An engineer could turn an old product into a new one. He may obsolete products, or make them unnecessarily complicated," Margolis claims. Careful direction of an engineer's efforts is needed after he's been exposed to customers, says Joseph Nola, manager of market planning for Sylvania Semiconductor of Woburn, Mass. "Otherwise you'll find a man has spent months working on an idea that's good for one customer," he warns.

Some see such singlemindedness as a serious drawback to the participation of engineers in product planning. David E. Musgrave, manager of marketing services

for Sperry's Microwave Electronics division of Clearwater, Fla., feels that the main problem for product planners is the "pride and bias" of engineers, their narrow interests and their wish to "maintain the status quo within their narrow capabilities."

Several companies have seen narrowness as a problem, but have taken steps to do something about it. Bell of Silicon General is a big believer in having the engineer understand how the company's products are applied, and he's an advocate of having broader engineers. Says he, "The technical person no longer is shielded from the customer by marketing in effective companies." Bell says some of the ways to broaden the engineer's capabilities are to encourage him to make visits to customer plants, attend seminars and trade shows, and to engage in technical interchanges in technical societies.

Many companies feel that they can scarcely do less, out of enlightened self-interest; otherwise they run the risk of alienating their engineers by cutting them off from the planning process. Charles Haines, director of product lines for Micro Systems, a minicomputer manufacturer in Santa Ana, Calif., says the rate of formation of new companies in the electronics industry in the past three years "is an indictment of inferior product planning." These people who are forming new companies "came from existing companies, got some training and experience there, and they didn't have a chance to express what they wanted to in that company, and found it very easy to go outside, get financing, and start a new company."

There is often conflict between engineering and sales people over market plans. Here, a product planner can act as a buffer, to break down the wall between the creative engineer and the marketing people. To bridge the gap, Raytheon's Communications and Data Processing operation of Norwood, Mass. has set up an "interface man"—Kenneth A. Backer, who has the title of chief, planning and development group—who must act like an "interpreter at the UN," according to Paul Harding, marketing manager for data display and switching systems. Harding found that before this arrangement, the necessary dialogue too often was bogged down, one side opposed to the "huckster" and the other opposed to the "long-haired scientific nut."

By getting the engineer more deeply involved in the product-planning loop, the interface man can avoid many of the problems that crop up when a plan is turned over to engineering for development. Sylvania Semiconductor's Nola says, "The key thing is that the engineer must feel he is part of an organization, part of a whole market-intelligence system." Unless he is brought into the loop, he may find it difficult or impossible to identify his contribution in the final product, especially when the system is complex.

By the same token, unless the engineer understands the goals of a product plan, he may be turned off if his ideas are rejected because they don't fit the plan immediately. Ken Backer of Raytheon says, "It's hard for an engineer to realize that his good idea just can not be used right now." But the product-planning interface can help here by making sure that the goals are properly understood.

What information and information sources do product planners use, aside from customers and company engi-

neers and salesmen? One of the principal sources is technical journals. Trak Microwave of St. Petersburg, Fla., for example, keeps track of military programs and the stage of their development through the technical press. Trak's marketing manager Tom Roberts can then decide when the time is ripe to approach a contractor with a proposal. For a small company like Trak, with 85% to 90% of its business in microwave oscillators, this is a simple and effective approach to product planning. "Since Trak is a small company," Roberts explains, "we don't go after large programs such as ABM, but look to subcontractors who develop the electronic gear" for such programs. By keeping in close touch with customers and keeping abreast of awards through the publications, Trak can move at the opportune time "to go to these contractors and get specs, and then see what we can offer."

Publications are also helpful in keeping track of the competition, and this information can be factored into product plans. "At Radiation, we keep abreast of the competition by talking to them. We also track our competitors very closely by reading the journals and looking for first announcements," says John Cecil, marketing development manager for memory products. Then, "when a new product is introduced by our competition, we call the distributor and find out their specs and price, and order a few items for evaluation."

Surveys are another frequently used device for gathering information about customer needs for new products. Companies will have outside agencies run surveys by mail, but without the source of the questions, so that the answers won't be biased and the competition is not tipped off.

Outside consulting services such as A.D. Little and Co. of Cambridge, Mass., and the Quantum Science Corp. of New York are often utilized. Such services have an enormous data base and can provide valuable quantitative information on the future needs of customers [see "Input-output," p. 88].

But what if a need doesn't exist? Or if the user doesn't know it exists? Here, the company's judgment is critical—it must decide if the idea is new and useful enough to be viable. Then it must start educating potential customers to create an awareness of need. Engineers at ECI, for instance, believed that an all-solid state, no-moving-parts uhf radio could be built. "We

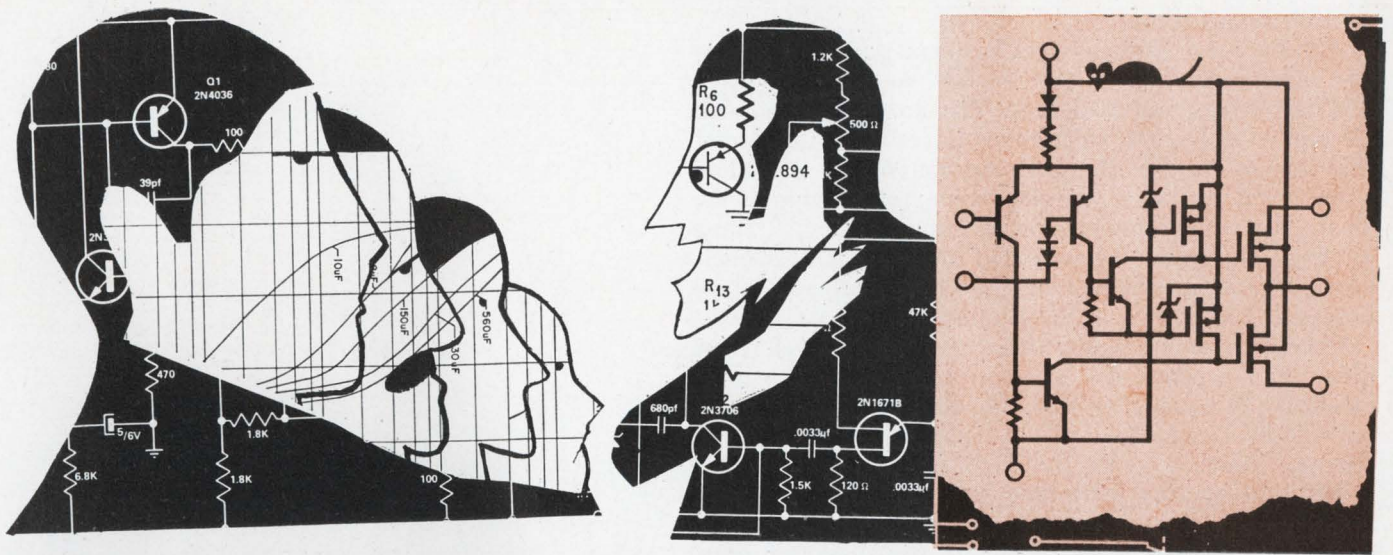

thought this was the thing of the future,” says ECI’s Joe Mensch, “but we had to sell the user on its merits. To do this, we ran a uhf symposium and invited 50 to 100 customers and Defense Department representatives. Our intent was to plant the seed that this was a viable device, and after a long gestation period a program evolved from all this. Although ECI has to develop it in-house, advertise it, and sell it to the user at our own expense, the payoff was a development contract.” Now ECI is hopeful of getting a five-year production contract. Moreover, we anticipate many other potential markets for this product.”

On a larger scale, Motorola Semiconductor of Phoenix, Ariz., put its money on emitter-coupled logic integrated circuits several years ago. Now, after talking up the high-speed advantage of ECI all that time, the company is just seeing a large market develop.

How important is technological forecasting to product planning? There are many elaborate and sophisticated techniques of technological forecasting. However, use of such techniques is largely limited to government agencies, extremely large aerospace firms, and think tanks like the Rand Corp. of Santa Monica, Calif. Such organizations try to predict the technology that will be available five, 10, 15 or more years in the future.

For the vast majority of firms, five years is the remote future. Their product planning is based on

the current state of the art and very short-term extrapolations of it. Les Smith, director of marketing for AC Electronics, a division of General Motors in Milwaukee, Wis., puts it this way: “A planned product requires a real-world market and a real-world application of the technology. Otherwise it would never be economical. The minimum period over which product planning is useful is about two years because it takes that long merely to develop a reasonably complex product, and the maximum period is about five years.” At that point technological obsolescence enters the picture.

“In my area—inertial guidance—our own people are best informed over a period of three to five years in the future,” says Les Smith. “Few companies have any expertise beyond this period, even large companies. The large companies can afford it, but most of them don’t do it.”

Why not? Well, technological forecasting is expensive, as Les Smith implies. Moreover, the accuracy of such forecasts is not easy to prove. And most significantly, many electronics companies are working in a fast-moving, dynamic, milieu in which even his estimate of two years as the minimum product lead time for planning is overly conservative. A year or less is the typical lead time for a radical new product in the integrated circuit business.

Perhaps the real value of technological forecasting today is in establishing corporate goals, considered along with variety of other factors, rather than in the planning of specific products. For example, TRW of Cleveland has a corporate long-range planning activity, handled by a business development committee, which each year examines old and new products. For this annual review, each division makes its own long-range plans, which are combined with plans for the TRW group of which it is a member, and the combined plan is submitted through the group’s general manager to corporate headquarters. Then “we examine the social, political, economic, and technological climates,” says Arnold Anchordoguy, manager of the development office at TRW Systems group, and try to assess how trends may affect our businesses both from the standpoint of opportunity and threat.” Members of the business-development committee include all operating division general managers, key staff specialists such as the chief scientists, and directors of marketing and planning



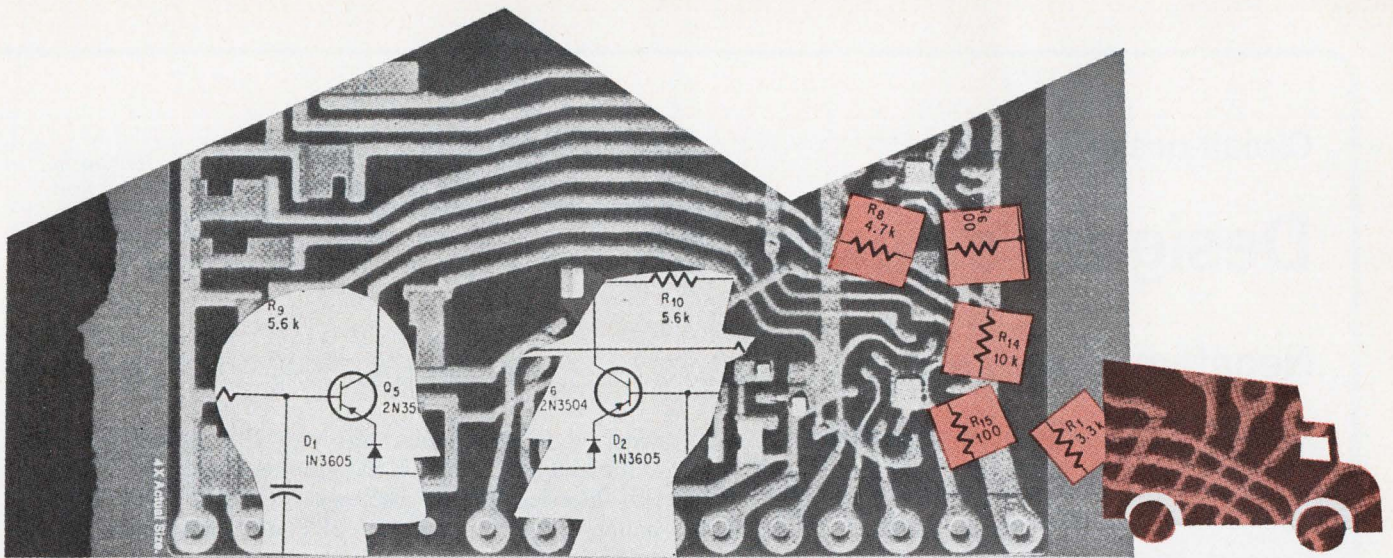

says Cope, to maintain the element of surprise and because "if you show reps a prototype, one of them is bound to go out and sell it, even though the product and its price may change quite a bit before it's available."

One common cause of product-planning failure in many companies is insufficient market research. The engineering department may have a pet technology that it is anxious to turn into a product, and as a result may have overly optimistic ideas about the market potential as a result of wishful thinking.

Another cause is failure to promote a product, to create a need for it. Roger Cady of DEC cites a case in point: the PDP-8 display system, which Cady says was somewhat ahead of its time and was too costly to get many customers interested. "If we had done some market research," says Cady, "we would have found little interest."

"But," Cady cautions, "the negative input—i.e., the market isn't there yet—is not necessarily a no-go indicator. Rather, it is a caution signal and may indicate that a reorientation of the marketing end of the product cycle is needed." In the case of the PDP-8 display, "there was less marketing strength involved than engineering strength; that is, we didn't create the market that was potentially there."

Another common cause of failure is insufficient production capacity. Sanders Associates offers an example: a cassette data recorder. Sanders originally developed its cassette technology as part of a classified contract, and felt that it might enter the data recording business as a result. "We chose an avionics application," Culligan says, "a recorder to aid real-time data reduction in an airborne antisub system." Unfortunately, "when we tried to sell it into the automatic in-flight data system (AIDS), we got hurt—low volume kept our price up, narrow product line cut our alternatives in relation to the competition's. We had no product line for ground support."

Sanders therefore couldn't prorate costs "across enough ledger columns to offset engineering and marketing costs. We had too much engineering—in house and in product."

Culligan continues, "I once talked with one of the men behind the cassette development, and he told me that his group had envisioned a broad range of

products. But for a wide line of products, you need a critical mass of organization to handle it. In this case, only one product was produced and the large mass of support personnel never materialized, as it would have if the product line had been broader. If the product line had been properly planned, the marketing would have sprung up and the recorder would have been a success."

An overly ambitious product plan can be dangerous, too, if the number of products exceed the capability of the production lines. Ray Stata of Analog Devices Inc. of Cambridge, Mass. offers an example: "Last year we had a general failing, in that product plans were put in motion that couldn't be implemented by the rest of the company. We came up with about 20 new products at the beginning of 1969. So we printed the catalog, with the products in them, and whoosh—in came the orders. And we really couldn't produce and deliver at the rate desired.

"Looking back," Stata says, "we would have spaced them out. Thus, while last year was successful, it was painful too.

"So this is an example of a failure of product planning which has little to do with the product itself. I think marketing and product planning failed in that they didn't realize the importance of timing in introduction. But I think there's no other place for such responsibility to reside. Somebody has to make sure that resources will fit together and play," says Stata.

Closely related to overly ambitious product planning is the problem of missed opportunities—also a form of failure in product planning. Stata analyzes the problem this way: "There's always a spectrum of opportunities available to you at any point in time. And you commit to certain ones on the basis of return on sales, market penetration, etc. And so long as everybody is whistling, nobody really worries about whether we might have done better with a different decision.

"Possible success using alternate paths is a difficult thing to evaluate," Stata continues. "I think it comes down to this: When you are making decisions, you should have on your desk a big heap of ideas and alternatives, and you should sort through them at the beginning to spot the best ones. It's better to have far more ideas than you can implement. Then you can pick and choose." ●

Designer's casebook

Designer's casebook is a regular feature in Electronics. Readers are invited to submit novel circuit ideas and unusual solutions to design problems. Descriptions should be clear. We'll pay \$50 for each item published.

Negative impedance stabilizes motor's speed

By Sam Ben-Yaakov

University of California, Los Angeles

A small d-c motor is subject to speed variations with load, even when driven by a constant voltage source. But a negative impedance inserted in series with the motor can hold speed variations under load to within 2% for a given control voltage setting over a long time period.

The electromotive force developed by the motor is linearly proportional to the motor's speed:

$$EMF = Kn$$

where K is a constant and n is the motor's speed. If the motor with internal resistance R_i is driven by a voltage source V_s with an internal resistance R_s , it will develop a speed:

$$n = \frac{EMF}{K} = \frac{V_s - i(R_s + R_i)}{K}$$

where i is the current through the motor. If R_s is made negative and equal in magnitude to R_i , then the speed equation reduces to V_s/K . Thus the motor's speed is a function of V_s and is independent of the load.

The negative resistance is achieved through a negative impedance converter, an operational amplifier connected with both positive and negative feedback. The source resistance presented to the motor, which is placed between the negative input of the op amp and ground, is controlled by the resistance ratio $-R_1R_3/R_2$ and can be adjusted to approach the value of R_i by the 2-kilohm R_1-R_2 potentiometer.

Although the nominal voltage of the motor is 6 volts, the control voltage can be adjusted to provide a wide range of motor speeds.

The capacitor prevents the circuit from oscillating, and the transistor generates the needed drive to the motor.

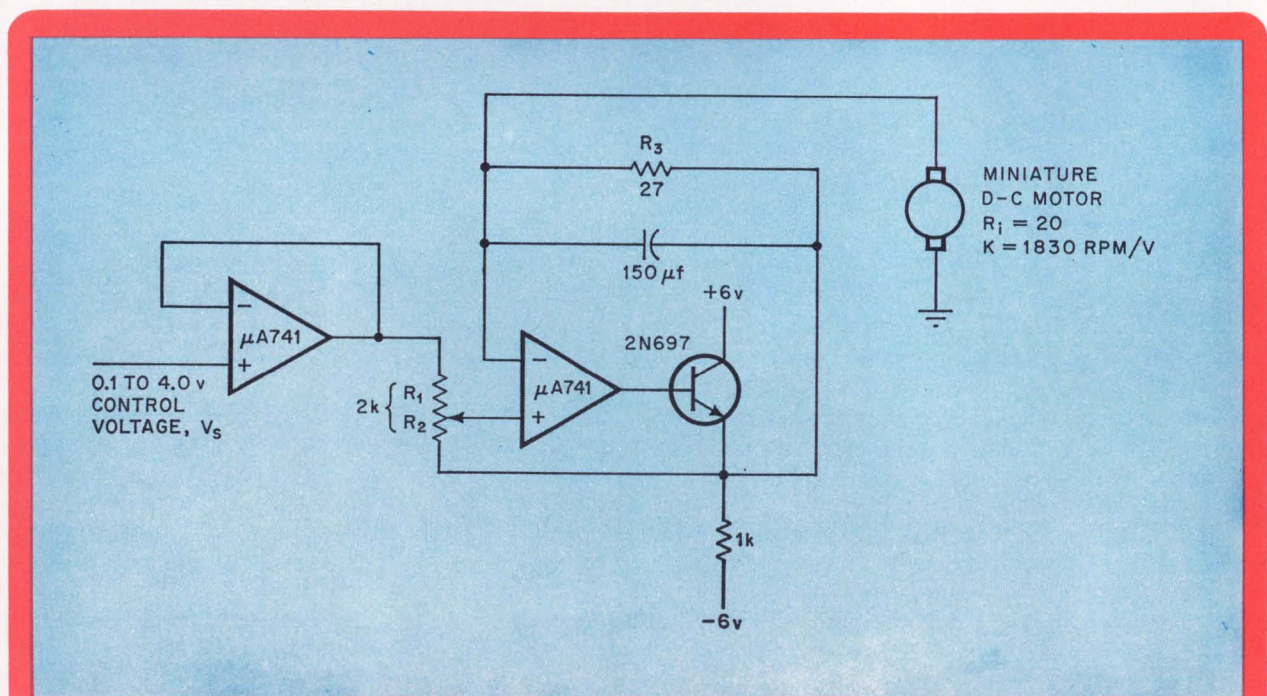

Negative impedance. The equivalent resistance of the motor's driving source is made equal to the negative of the motor's internal resistance thereby rendering the motor's speed independent of load variations. The negative impedance is measured at the op amp's negative terminal with respect to ground.

Signal detector operates from 5-volt supply

By D.K. Smith

General Dynamics Corp., San Diego, Calif.

A unijunction transistor circuit that detects the presence or absence of signals can be easily used with a digital logic network. This feature is made possible by its ability to operate from a 5-volt supply and its low power consumption—18 milliwatts. When a signal is present, the output across the load rises to the supply voltage level, while in the absence of a signal the output falls to ground.

The timing circuit consists of the unijunction transistor Q_2 , timing components R_t and C_t , and the silicon controlled rectifier Q_3 and its associated resistors. The unijunction transistor normally is free-running at a frequency determined by R_t and

C_t . The SCR thus is continually triggered and turned on through the load. The output remains at ground, indicating the absence of an input signal.

A signal arriving at the input, turns on transistor Q_1 . The unijunction transistor's emitter is grounded, thus inhibiting the timing circuit. In addition, Q_1 transmits a negative-going pulse through diode D_1 and the capacitor C_c to Q_3 's anode, turning off Q_3 . The voltage at the detector load's output rises, indicating that an input signal is present.

When the input signal terminates, the timing circuit is again freed, but only after a time lapse determined by the period of the unijunction circuit. If another input pulse arrives before Q_2 is triggered, the time lapse is restarted.

The holding time may be varied from a few microseconds to a few seconds.

The detector load is current-sinking logic which provides the holding current for the SCR. The purpose of the resistor R_g is to reduce the holding current requirement for the SCR.

The circuit has been operated over a temperature range of -25°C to $+75^\circ\text{C}$.

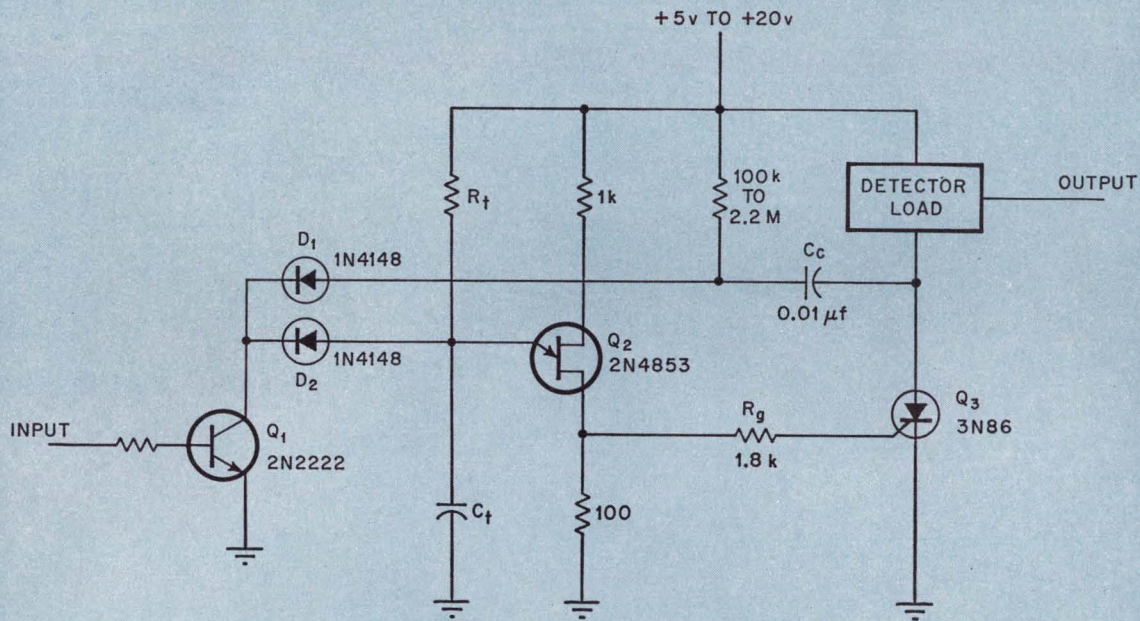

$R_t = 47\text{ k}$
 $C_t = 0.1\ \mu\text{f}$ } TIME LAPSE 7 MILLISECONDS
 $R_t = 390\text{ k}$
 $C_t = 2.2\ \mu\text{f}$ } TIME LAPSE 1.4 SECONDS

Knowing when. When a signal is present at the input, Q_1 turns on, grounding the unijunction transistor's emitter and inhibiting the timing circuit. In addition, a negative-going signal is transmitted to Q_3 's anode, turning off the SCR. The voltage across the load rises, indicating the presence of an input signal.

Inverted-mode transistors give chopper low offset

By R.C. Scheerer and J. Logis

Westinghouse Defense and Space Center, Wash., D.C.

A balanced chopper transistor modulator using two npn and two pnp transistors connected in the inverted mode instead of the standard transistor configuration give a much lower offset voltage. Furthermore, the need for matched transistor pairs is eliminated, while only one secondary winding is required in the transformer.

The circuit is useful in chopper-stabilizing amplifiers, frequency-modulated oscillators, synchronous modulating/demodulating circuits and regulated a-c power supply design.

Most other designs require matched transistors so that the collector-emitter saturation voltages cancel and track with temperature variations. In this modulator, the transistors connected in the inverted mode have a saturation voltage of 2 to 4 millivolts and offset voltages are usually as much

as four times less than in other designs.

On positive-half cycles of the modulating excitation voltage, E_m , the base-collector junctions of Q_2 and Q_4 are forward-biased, and these transistors conduct. Transistors Q_1 and Q_3 are reverse-biased and remain off. Current flow through the collector-base junctions of Q_1 and Q_3 is blocked by diode D_1 ; the output voltage thus is at ground potential. Since the chopper transistor is connected in the inverted mode, a much lower $V_{ce(sat)}$ is obtained (2 to 4 millivolts), against the 0.2 to 0.4 volts obtained for standard transistor saturation voltages.

And since the emitter-collector voltages of the conducting pair of transistors are equal but opposite in polarity and tend to cancel each other, the offset is further minimized. These voltages tend to track with temperature.

On negative-half cycles, the base-collector junctions of transistors Q_1 and Q_3 are forward-biased, thus driving the transistors into saturation. Sufficient base drive is obtained by the proper selection of resistors R_{b1} and R_{b3} . Transistors Q_2 and Q_4 are reverse-biased and remain off during the negative cycle. Current flow through the collector-base junctions of Q_2 and Q_4 is blocked by diode D_2 . The voltage at the output during this interval rises to the input voltage, E_{in} .

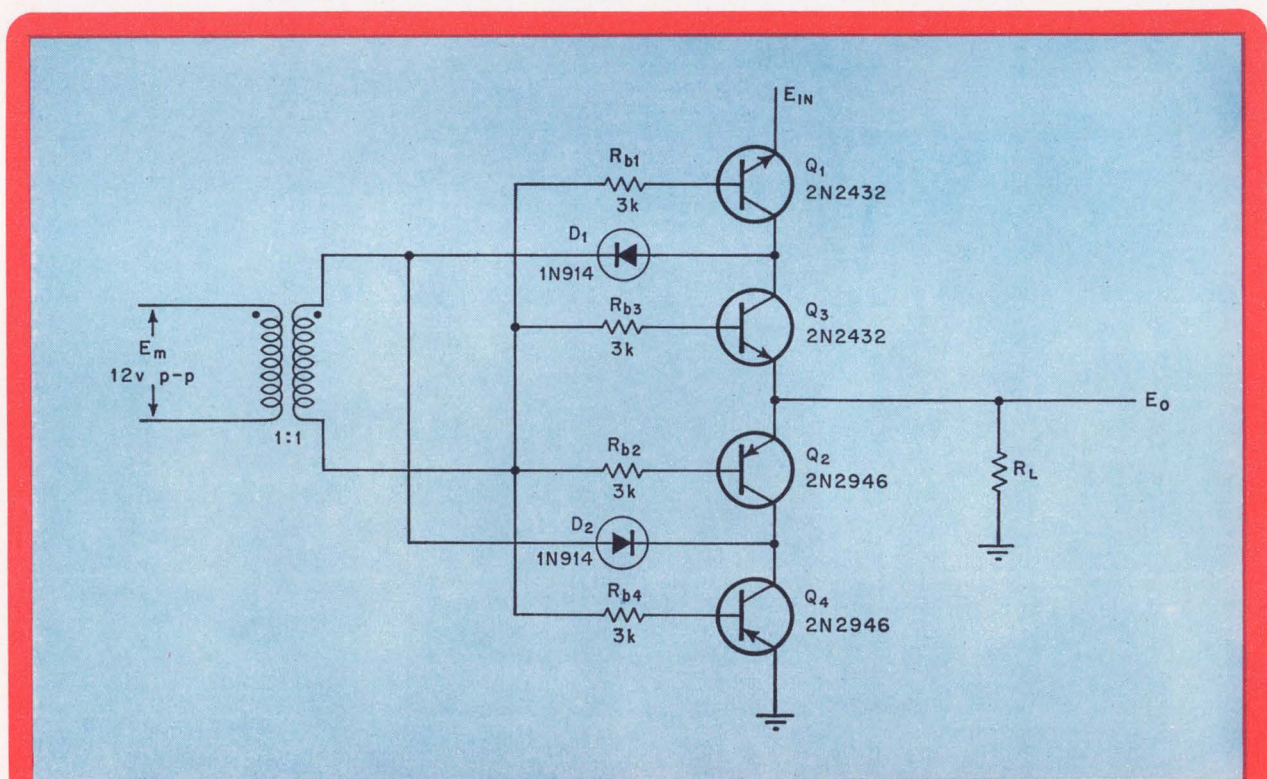

Modulator. Chopper transistors (two npn's and two pnp's) are used in their inverted mode instead of the standard configuration to produce saturation voltages in the range of 2 to 4 millivolts, against the common saturation voltages of 0.2 to 0.4 volts in other modulator designs.

Why sacrifice power for size?

You might need a magnifying glass to closely examine RCA's new gallium arsenide high efficiency infrared emitting diode. But small as it is, the 40736R's power and versatility open a whole new world of applications for electro-optical systems designers.

Here's why. The miniscule GaAs emitter is contained in a compact OP-10 package with an overall diameter of less than 0.095 inch. Thus, it is well-suited to closely-spaced printed-circuit board mountings where minimum crosstalk is a prime requirement. And the 40736R uses a unique parabolic reflector to pack 1.6 mW (typ.) radiant power output (at 50 mA drive current continuous service) into a narrow collimated beam pattern cone—15° half angle, half power. In pulse service, up to 1.5 A drive current may be used. Typical P_0 is 24 mW at 1 A. Center wavelength for both continuous and pulse service is 9300 angstroms.

Use the 40736R to design: punched-card and tape readers • high speed counters • edge trackers • encoders • intrusion alarms • small bomb fuzes • end-of-tape indicators • line finders • data transmitters • circuit isolators • film coders.

Is your application one of them?

For further details, see your local RCA Representative or your RCA Distributor. Or write to RCA Electronic Components, Commercial Engineering, Section SN3-30/US5, Harrison, N. J. 07029. In Europe: RCA International Marketing S.A., 2-4 rue du Lièvre, 1227 Geneva, Switzerland.

RCA

RCA's 40736R GaAs IR diode emits more power from a smaller package



Thinking of getting into CAD? You don't have to go far to find a program

There are many programs from which to choose; South Florida University's G. W. Zobrist looks at what's available

● Largely confined to academic discussion only two years ago, computer-aided design now is a practical tool for designing and analyzing electronic circuits. Today's circuit designer can call upon many CAD programs to perform analysis, synthesis, simulation, sensitivity, and parameter variations on circuits. But to select the program that provides the best results, the design engineer must know both the capabilities and the shortcomings of CAD programs.

Basically, computer programs fall into two categories—first and second generation. Existing CAD programs, such as NET-1, ECAP, Circus, Sceptre, and Nasap are considered first generation; those that will become available during the next three years are called second generation.

First-generation programs have languages that permit designers to specify their circuit problems simply and in universal formats such as Fortran. Although the first-generation programs are widely accepted as doing a good job, they are based on circuit and numerical analysis techniques available in 1965, and are still far from perfect. Among their shortcomings are:

▶ No macro capability in the input languages. Elements that may be used repeatedly in a circuit must be described each time they are required.

▶ Algebraic expressions cannot be used with most input languages to describe desired functions. Only piecewise

linear functions are available to accomplish this aim.

▶ Circuits or waveforms usually cannot be stored because the program requires too much memory.

▶ Most programs have dense matrices, limiting the size of the design. Dense matrices don't take advantage of the zeros in the array which, when arranged in a certain order, speed up the mathematical solution and save memory space. Almost all 1965 numerical analysis techniques and algorithms had dense matrices; sparse matrix methods have been applied to circuit analysis only in the last two years, and if done in circuits with approximately 50 or more components, the techniques reduce analysis time by an order of magnitude.

▶ Time-constant selections limit transient analysis. To obtain a transient solution, the machine must solve an integral. If small time steps are chosen, the solution can take a long time; while with large time steps, instability, as well as an incorrect solution, can result.

Among other shortcomings, storage space is inadequate for varying parameters. For example, assessing the effect of a small temperature increase on a circuit cannot be done easily. There is no means for improving circuit designs through automated programmed optimization. And since batch processing is the prime method under which programs operate, if there is an error on the input card, the wrong result would not be obvious until the output is plotted.

Hopefully, second-generation programs such as NET-2 and Circus-2 will eliminate most of these difficulties. When completed, NET-2 is expected to offer expressions to describe nonlinear functions with Fortran; trapezoidal integration with a variable step size that can be controlled automatically, or as specified by the user, eliminating wrong guesses that produce incorrect results, and routines for solving nonlinear algebraic and differential equations, presently unavailable.

NET-2 also will feature transient, d-c, and linearized a-c analyses, each available in a Monte-Carlo mode for statistical problems, an optimization mode for minimizing components, and a parameter-variation mode to determine the effect of a component change on the circuit. Also expected are a library of commonly used symbols to which the user can add, a macro feature, and sparse matrix techniques.

Circus-2 is expected to offer a facility for storing waveforms; a library of topology and parameter values for

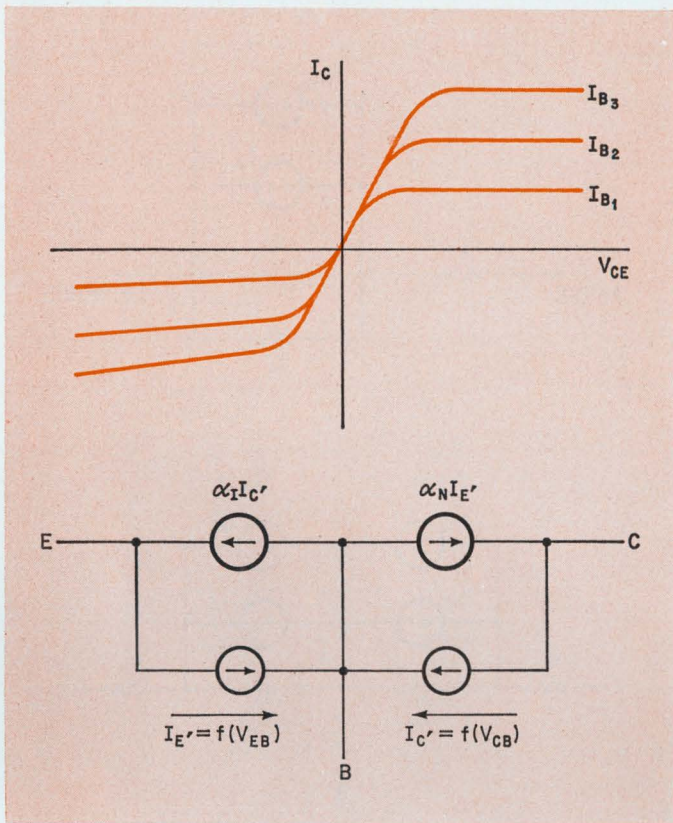

High accuracy. An Ebers-Moll model is a more accurate technique for determining the nonlinear behavior of a transistor than the piecewise models.

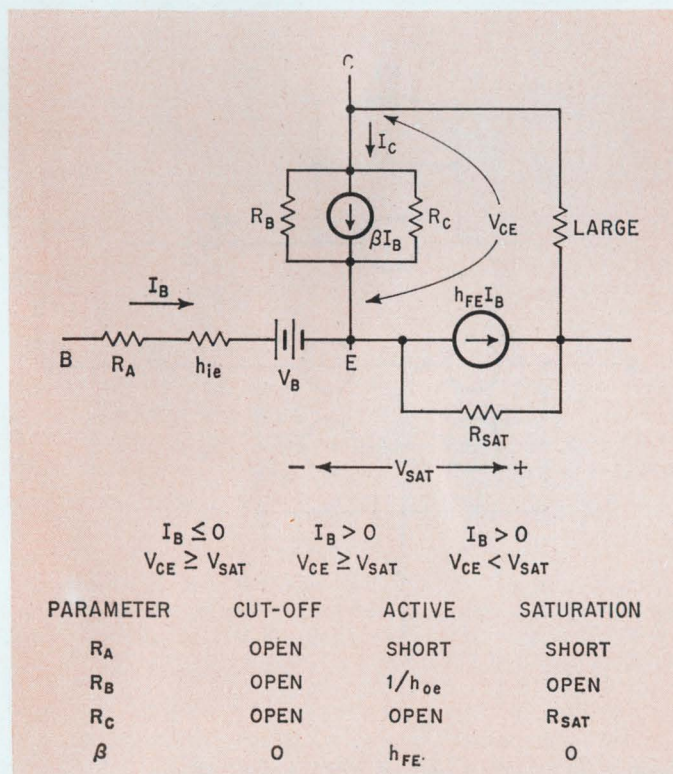
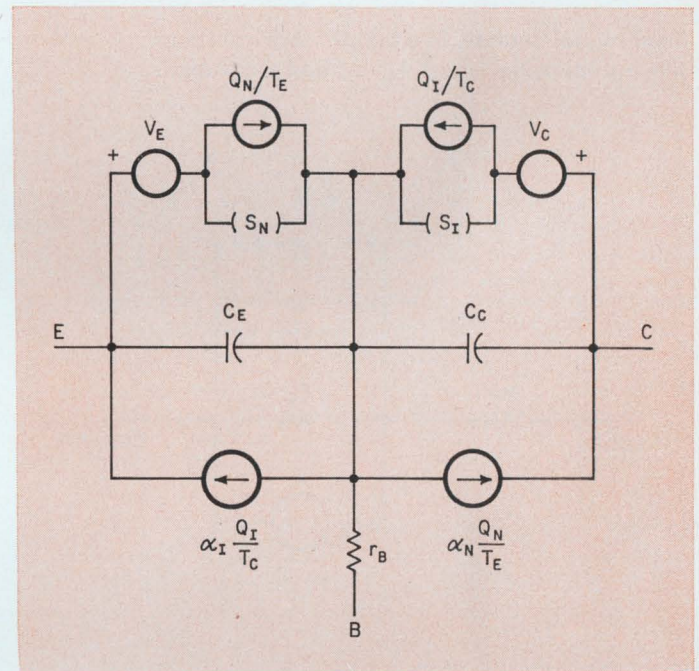
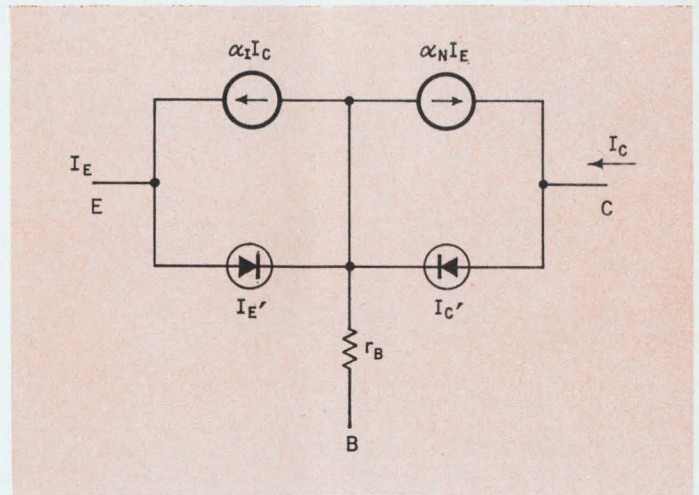

Piecewise. The piecewise approach to transistor analysis requires the operating region to be subdivided into three parts—each region requires a separate model.

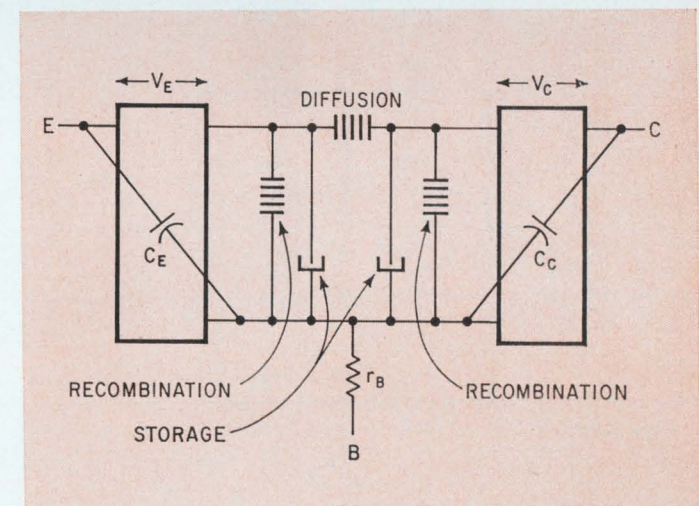

Transient analysis. Three basic models for analyzing transient behavior in a semiconductor are the Ebers-Moll, top, charge control, center, and the Linvill, bottom. Each can be described by a set of equations and each can be represented in terms of the relationships with the others.

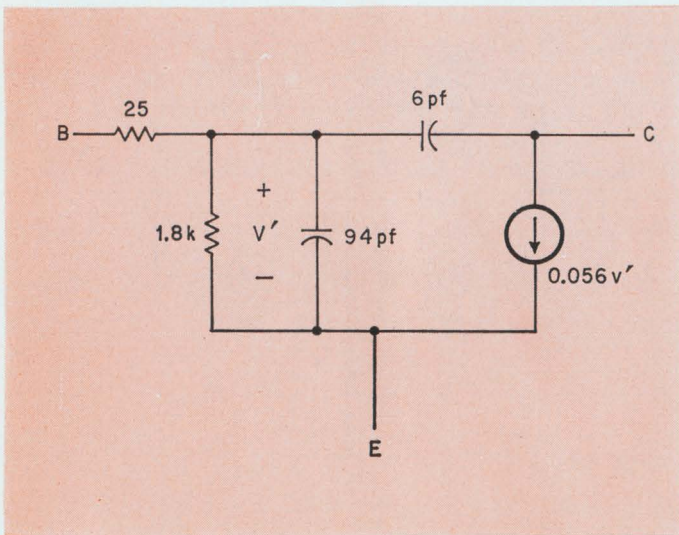

Small-signal analysis. In programs such as Nasap, a hybrid-pi model is useful in a-c and d-c analysis.

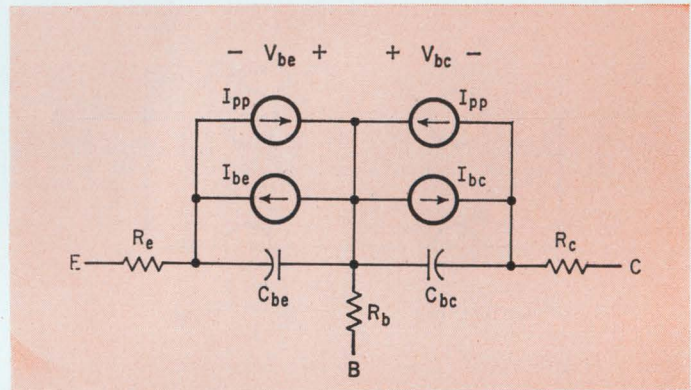
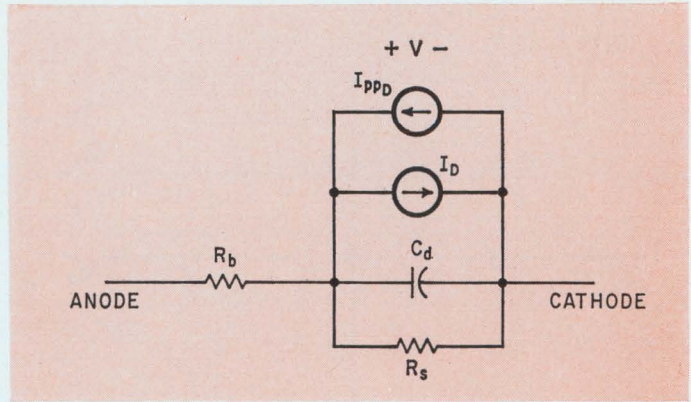

Modified Net-1. Charge-control model, a modified version of NET-1, is used in programs such as Circus. At top is the diode version, on the bottom, for transistors.

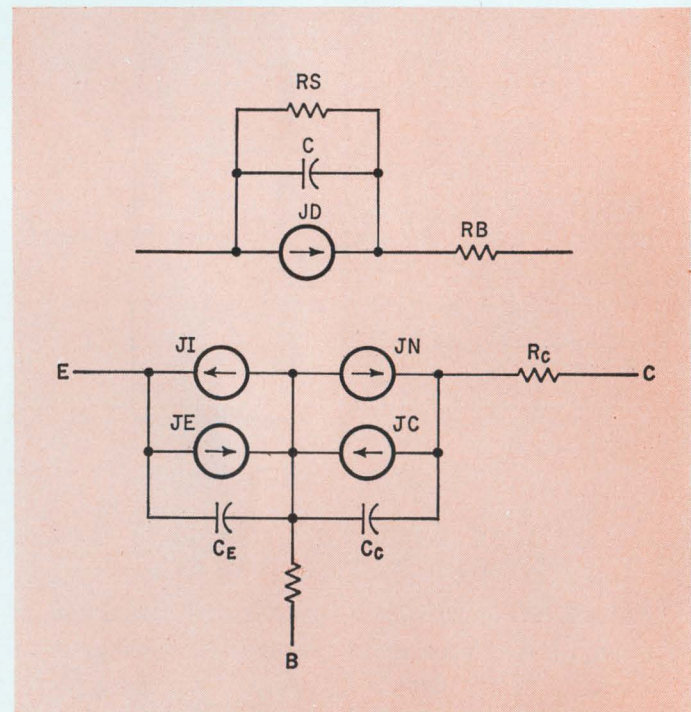
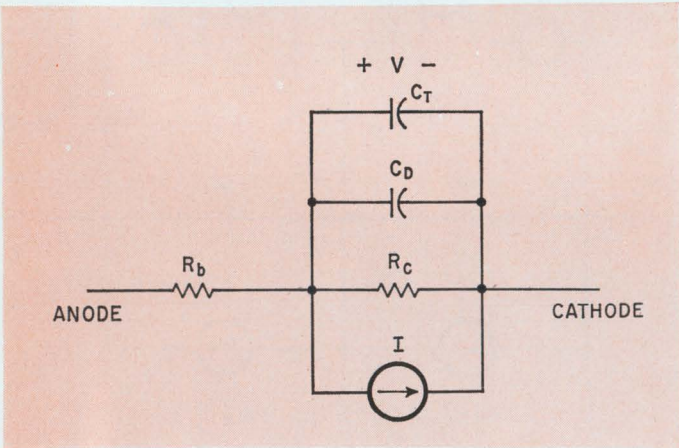

Sceptre. In programs such as Sceptre, another variation of the Ebers-Moll model is used. This program, unlike NET-1 and Circus, offers the designer the option of modifying the parameters. Diode version is at top, transistor at bottom.

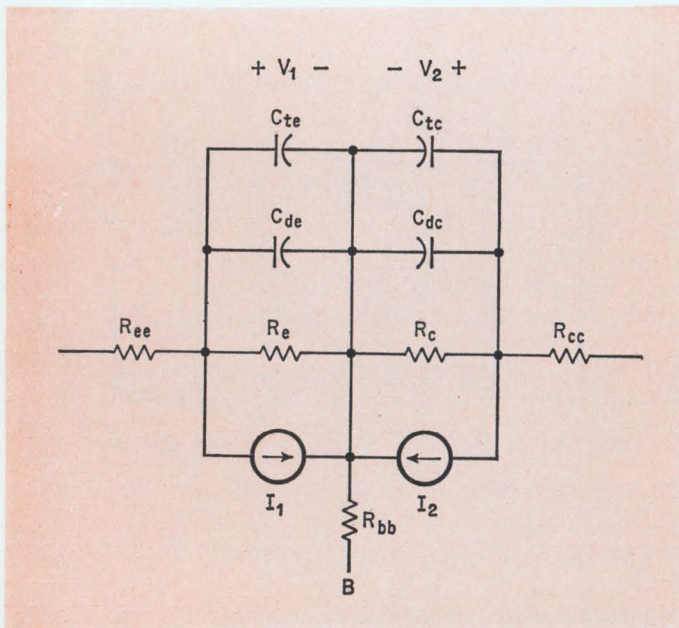

Modified Ebers-Moll. A variation of the Ebers-Moll model is the NET-1 circuit. At top is the one used for analyzing diodes; the one on the bottom is used for transistors.

devices, and an explicit integration scheme. In Circus-2, transient, d-c and linearized a-c analyses will be available in an optimization mode. Capabilities also will include a macro feature, and expressions to describe nonlinearities and probability functions with Fortran.

Two desirable features for subsequent second-generation programs are a graphical output and an open-ended language that permits users to combine commonly used commands into macro commands, allowing the operator to obtain results visually and quickly.

Invalidities sometimes crop up in some present programs; these result from program operation, rather than the model itself. Invalidities include:

▶ Models used in the computer analysis programs described are limited to lumped elements; the result may be invalid for very high frequencies where distributed parameters are needed.

▶ In semiconductor devices a small drift in voltage can result in a large current change. In the iteration process a large junction voltage is generated that causes a current whose numerical value exceeds the machine's arithmetic capability. A scheme to prevent this is to assign a maximum junction voltage, or to change the device's operating point by a smaller amount than indicated.

▶ Some networks have more than one steady-state solution. The initial condition information must be supplied

to insure that the correct solution is obtained.

▶ A practical device model is usually only useful over a limited range of its operation. For example, the hybrid model of the transistor does not predict the steady state frequency response over a wide band, the Ebers-Moll model does not predict a-c small-signal response accurately. The Ebers-Moll and/or first-order charge-control model do not satisfactorily represent saturating transistors at moderate switching speeds. Therefore, the designer must know the model's limitations.

▶ The simple model may not predict phenomena such as thermal effects, noise properties, radiation effects, and energy storage. Special, and probably more complex, models may be required to investigate these effects.

▶ The time-step solution—the size of the time increments elected during integration—is one of the most important decisions the user has to make for a transient analysis once an appropriate model has been formulated. The choice of a time step is important for two reasons: numerical accuracy and computation time.

Numerical accuracy is affected by the time-step selection if the time step is too large due to the resulting poor approximation to the desired integral. If the time step is too small, each of the summation's terms may lie outside the precision range of the computer when compared to the total sum of all contributions. Therefore, the time step must be chosen so that it is both small enough to yield an accurate solution and large enough to preclude excessive computer time.

A trial-and-error procedure can be used to establish a suitable time step. First, a transient solution is run for a short interval for a selected time constant. Then the time step is reduced until no significant changes result. If, on the first examination, the response compares satisfactorily, the time step may be too small, and the procedure is reversed.

Numerical instability sometimes results if the time step is too large. This can be observed in the output as a departure from the smooth variation of the voltage or currents. The best choice is the largest possible time step that yields acceptable results.

One way to judiciously choose an initial time step is to tabulate all the local time constants or local natural periods.

The model's time constants usually determine the running time of the computer program. This can be a severe limitation in networks having a large ratio of largest-to-smallest time constants. The smallest time constant controls the permissible integration step size; the largest determines the network behavior and, therefore, the time interval over which integration must be performed. If the integration step size is not kept in line with the smallest time constant, numerical instability results.

There are implicit integration routines that do not have this restriction, but they are of little value because of their low-order accuracy.

The problem of small time constants should not be approached by developing more elaborate integration schemes, but by finding useful transformations for the branch-node connection matrix, since this matrix contains the information concerning the time constants.

One approach is to transform the branch-node connection matrix into a more desirable form and thus reduce the ratio of largest-to-smallest-time constants. This

greatly increases the integration step size but retains numerical stability.

There's yet another factor that must be considered in CAD programs: before they can perform accurately they must be able to exactly describe a circuit to the computer. To do this, a model must accurately represent a component's voltage or current. Since agreement between computed results and actual circuit performance is still entirely dependent on device modeling, without accurate models to describe the physical processes taking place in a circuit, computer calculations are just wasted effort.

Ideal models must accurately reflect the device's electrical performance under all operating conditions. There are two common approaches that meet these conditions—the mathematical and the physical models. The mathematical model is aimed at the requirement for computational efficiency. The physical model represents the natural processes taking place within the device. The two have different characteristics.

In the mathematical modeling technique, a device is defined through an equation. The equations are based on the z-, y-, h-, or s-parameters. The designer first decides which set of parameters is best suited to the design problem, then he obtains values for the parameters by directly measuring at specific frequencies of interest. Last, he inserts the model information into the overall circuit description and solves.

The mathematical model is best applied when device physics are not known, and linearity is the basis of all mathematical methods. For bipolar transistors, linearity applies only to small-signal behavior, so a mathematically based model usually is not applicable. Small-signal transistor circuits in the very-high and ultra-high frequency ranges are good examples for mathematical analysis because s-parameters are easily obtained without requiring short circuits.

The major objection to mathematical models is that they do not consider the device's physics since z-, y-, h-, and s-parameter models apply only to frequencies and operating points where measurements are made and do not reflect the material makeup of a device. Operating conditions usually are not known before a circuit analysis is performed; therefore, these models are applicable only where a device's characteristics are varying slowly.

With the physical model the designer first represents the physical properties of the device symbolically. Then he relates these to an equivalent circuit. Finally, the circuit is simplified as far as possible; the model parameters are measured, evaluated, and inserted into the overall circuit for final solution.

Models based on the device's physical properties are applicable for most frequencies and operating conditions. These do not require as many measurements as their mathematical counterparts, and nonlinearities are easily handled. But since the physical model is a simple one, it is usually not as accurate as one that's directly measured at a specific point of evaluation. And the language used to describe the parameters in physical models is not easily adapted for use in a given circuit analysis program because it is not commonly known.

But both mathematical and physical modeling involve several basic procedures and have much in common.

Electronic components may be modeled as linear, piecewise linear, or nonlinear, and may be subjected to

Diode modeling. Three models represent a diode for its three regions of linear operation.

d-c, a-c, or transient operation. The models also may contain information regarding thermal, radiation, and electromagnetic effects. Every circuit can be represented by a model made up of resistor-inductor-capacitor elements and dependent sources that can be linear or nonlinear.

The linear model of a solid-state device is only valid for small-signal operation. In a transistor, for example, a different model must be used for the cutoff, active, and saturation regions. When the model is used outside the intended region the results are invalid.

A practical modeling approach is to decompose the voltage-current characteristics of the device into linear regions, represented by lumped elements. The designer must make sure that variables external to the device stay within valid limits.

A linear d-c model for a diode and a transistor are shown at the top of facing page. Even though this circuit is for a particular configuration the models are applicable for others. Linear d-c models can be quite useful in applications such as saturating circuits, where the state or region of operation is predictable.

The a-c circuit models can be divided into two general classes: those where the energy, or frequency effects are negligible, and those where this approximation can not be made.

In the first case, conventional two-port parameters

Transistor modeling. Three models represent a transistor for the saturation, active, and cutoff regions of linear operation.

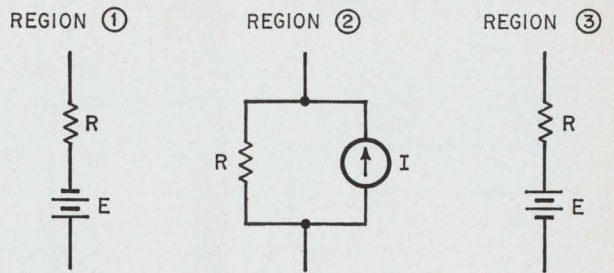
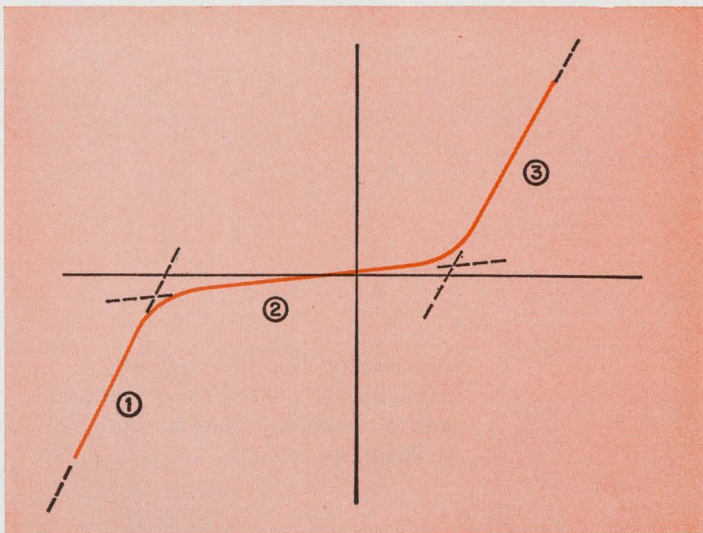

can be used. The h-parameter matrix is the most useful, since its parameters relate to those of the device's physical properties that are easy to measure. In the latter case, the hybrid- π model is useful for describing circuit operation, but not for high-frequency and field effect transistors. The hybrid and hybrid- π models for a transistor are shown on the next page.

Multiterminal linear devices can be analyzed through a black-box approach, representing the linear multiterminal device by an experimentally obtained frequency response matrix. With this approach there is no fundamental difference between lumped, distributed, or ideal networks. It is also feasible to accept experimental as well as analytical data to describe the multiterminal device. Indefinite transfer matrices are used as the analytical tool to characterize these multiterminal devices; they are later embedded into a network.

Solid-state devices typically are nonlinear except for small fluctuations around an operating point where the linear assumption usually is valid. To analyze operation in these nonlinear regions, the designer relies on three techniques: piecewise linear, or nonlinear analytic equations, and graphics.

The piecewise linear representation is an approximation of the device's characteristic curves. Its linear model can be presented in several forms; two that are commonly used are shown on page 106. The model at

the bottom is a simplified representation. The junction effects are supplied by the ideal diodes and the transfer effects by the dependent current sources.

In applications such as switching, the transistor is driven into more than one operational region. To represent the device under such behavior, the model must describe the device accurately throughout all regions.

Two basic approaches that work for modeling solid state devices for large-signal operation are piecewise linear and continuous representation. These models are based on the current flow in the semiconductor material.

In the piecewise-linear approach, transistor operation is broken down into several linear regions, usually cut-off, active, and saturation. A different model serves for each region; a total operational picture of the device is developed by matching boundary conditions at each subregion.

The other approach is to formulate a model that is continuous over the device's entire operating range. In this approach, the current is composed of drift and diffusion components, continuity relations, net space charge, and electric field. Three basic models are based on this approach: the Ebers-Moll, charge control, and Linvill lumped model.

The Ebers-Moll, based upon the superposition of a forward and reversed biased transistor, represent nonlinearly more accurately than piecewise models. The emit-

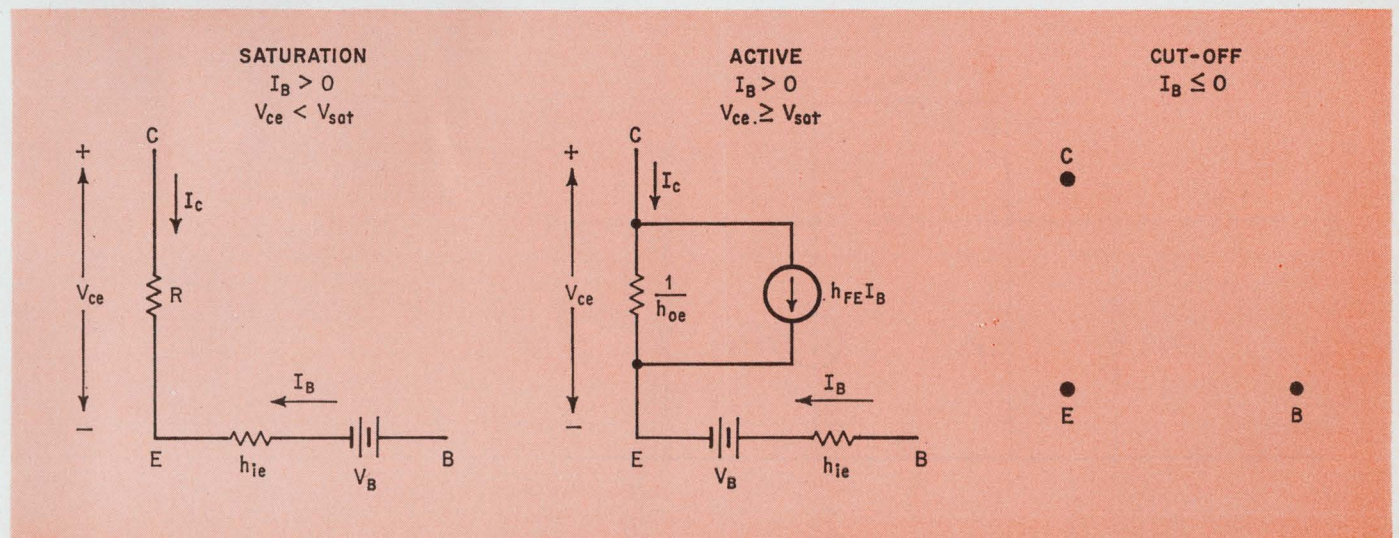

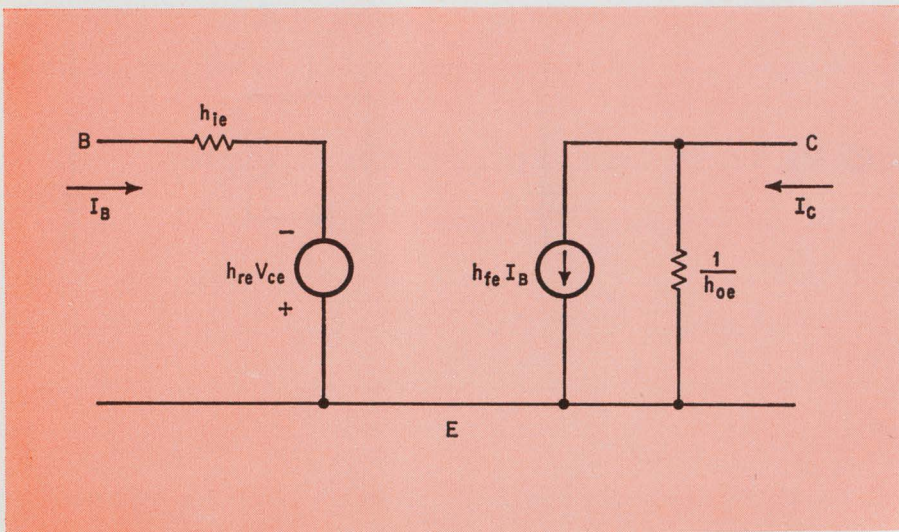

A-c modeling. Hybrid model, left, and hybrid-pi, bottom, show two basic ways to represent a transistor during a-c linear operation.

ter-to-base and base-to-collector junctions are described by capacitors and diodes, while the base region is represented by frequency-dependent current sources. This model is based on commonly used electrical quantities and has found wide acceptance. Its main disadvantage, however, is that there is little relation to the physical properties of the device.

The charge-control model introduced by R. Beaufoy and J.J. Sparkes was developed by viewing the device as a charge-controlled current source. Although also a mathematical tool, it's not as easy to use as the Ebers-Moll model.

The Linvill lumped model directly represents the continuity and diffusion equations. Related to the physical properties of the semiconductor, it's very useful in describing thermal and radiation effects. In this approach the designer divides the semiconductor into finite regions and analyzes these through finite difference equations that represent continuity and boundary conditions. The larger the number of finite regions, the greater the precision. One disadvantage, however, is that the values required to represent these regions are not directly measurable.

A modified charge control theory has been developed that interrelates the Ebers-Moll model (electrical), Beaufoy-Sparkes charge control model (mathematical), and Linvill lumped model (physical). The characteristic equa-

tions become identical for the three when appropriate measurable parameters are substituted for each term in a model's equation. Thus, all three models have the same natural frequencies, and are equivalent in transient response.

Hybrid and hybrid-pi models usually are used for semiconductors in linear small-signal programs. The programs are most useful in a-c analysis or d-c operation. However, they are not capable of handling piecewise linear operation, so saturation, cutoff, or large signal variations cannot be taken into account.

One such program is Nasap, and a typical hybrid-pi model for Nasap is shown below. The output is a transfer function in terms of the complex variable s . A transient response is obtained by performing an inverse Laplace transform of the transfer function. If semiconductors are used, the designer must be certain that the device, embedded in the network, is operated in a linear region. If frequency response studies are performed through this program, the hybrid-pi model is the most useful because it's applicable over a wide band of frequencies. Other computer programs that rely on topology to obtain the transfer function have the same properties.

The NET-1 program uses a modified Ebers-Moll model that is prestored in the computer; it's brought into use by specifying the transistor model number under which

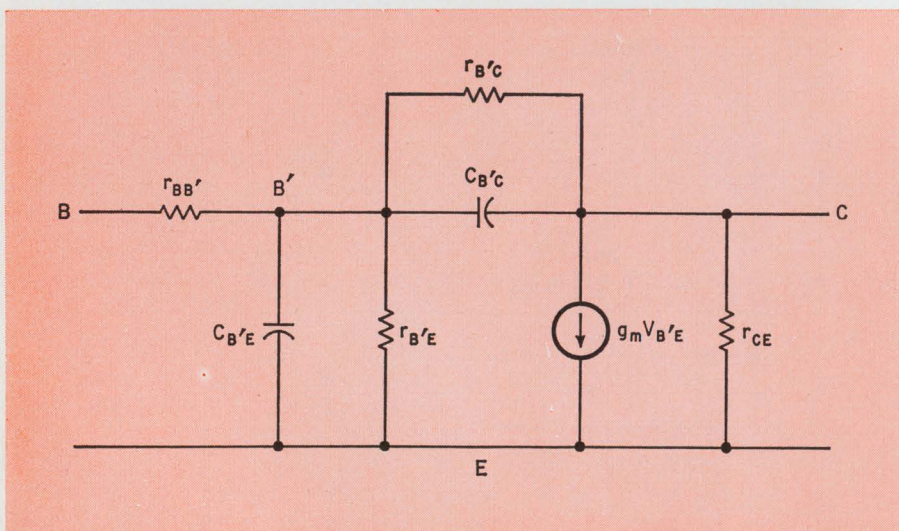

the device was stored. The model does not include breakdown, base narrowing, or conductivity modulation, but it does provide for modification of individual parameters.

This model is basically similar to the Ebers-Moll, but includes collector resistance R_c , and bulk resistors R_{ee} , and R_{cc} . The emitter and collector diffusion capacitances C_{de} and c_{dc} , and current generators have been modified somewhat by adding constants M_e and M_c . This enables the operator to account for variations in the device's characteristics between q/kt and $q/2kt$. The current gains also are expressed as functions of the junction voltage.

The same model used in NET-1, with a change in notations, is also used in Circus. One available program converts the equations for the NET-1 model into those needed for Circus—the first order charge-control model is completely equivalent to the Ebers-Moll model if measurable parameters are inserted. There are two differences in the model: the gain is modeled by a table of values that are dependent upon current; and the values then are linearly interpolated to find β , so the diffusion capacitance becomes a function of current through a set of tabulated values. The result is that the Circus model has a discontinuous first derivative which cannot be solved mathematically—usually, graphic techniques as well as mathematical are required.

Sceptre, another CAD program, also uses the Ebers-Moll model as its basic element for transistors. Unlike NET-1 or Circus, Sceptre can be used to enter or modify any model.

In modeling diodes, the usual procedure is to enter the current generator, which is a function of the junction voltage, using the equation $i_d = i_s (e^{qV_j/kT} - 1)$. But to do so, accurate measured values for i_s and θ are required. A preferred procedure is to enter the terminal characteristics of the diode by measuring the diode current as a function of the voltage across it. This information then is tabulated and stored in the machine until it is needed.

Shunt capacitance should not be removed, as is usual in a low-frequency application, because the current generator depends on the voltage across it. Therefore, since it is an internal state variable, the current source is updated at the start of each time-step solution. If the capacitor is removed, the current source is based on the voltage across either the current generator or a shunt resistance from the preceding solution. This results in a computational delay and also may cause significant errors.

The transistor model shown at bottom left of page 100 is the conventional modified Ebers-Moll equivalent circuit as described for NET-1. The nonconstant character of R_{bb} can be accommodated by entering the diode equation in tabulated form. The effect of bulk resistor R_{cc} also can be included by using a tabulated function for the base-collector junction diode equation.

Provision for a small-signal equivalent circuit for transistor or diode operation also is available in Sceptre. These models do not account for saturation or cutoff; any large-signal variation produces invalid results.

A modified Ebers-Moll model for a zener and a tunnel diode also has been developed and is suitable for use with Sceptre. This modeling of a zener diode is effected by adding additional current sources to approximate the voltage regulation when breakdown occurs. The tunnel diode is described by a tabulation of voltage-current characteristics.

Radiation effects can be incorporated into Sceptre, as well as in NET-1 and Circus, by including a time-dependent current generator in parallel with the equivalent junction circuit. This model usually suffices to describe the flow of charge across the semiconductor

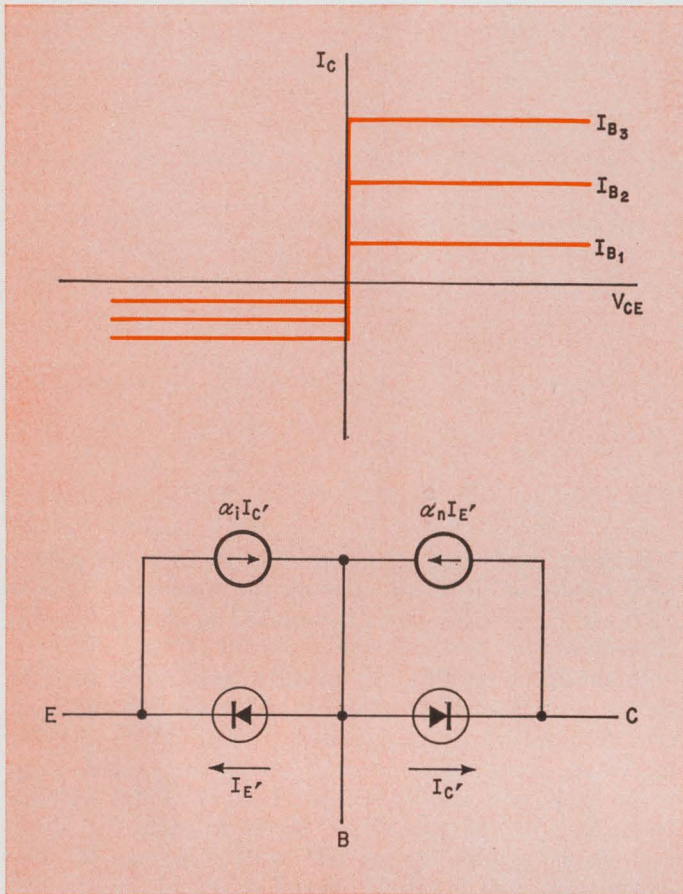

junction that occurs under certain kind of radiation.

Transistor and diode models for the ECAP program include the standard elements—R,L,C—dependent current sources, and a very generalized ideal switch. The switch permits a piecewise linear model to be used to characterize solid state devices employed in large signal applications.

Transistors in the network usually exist in any one of three regions of operation—active, cutoff, or saturation. During analysis a transistor may change from one region to another. To account for this, a three-region model was developed for ECAP to describe the small signal linear, cut-off, and saturated operation. In a d-c or an a-c analysis, the transistors remain in the region established by the operating point of the network.

The three-region model, given on the next page, is used effectively to simulate a transistor that changes operating regions during the analysis. Diodes can be simulated by a model which can be switched between the conducting and nonconducting regions.

Practical models should be simple and accurate. Since the computer analysis programs available now analyze networks with less than 30 elements, the model selected for this system should not be overly complex. One approach is to disregard parameters of a complex model which do not contribute significantly to the overall solution. The tradeoff is a compromise between numer-

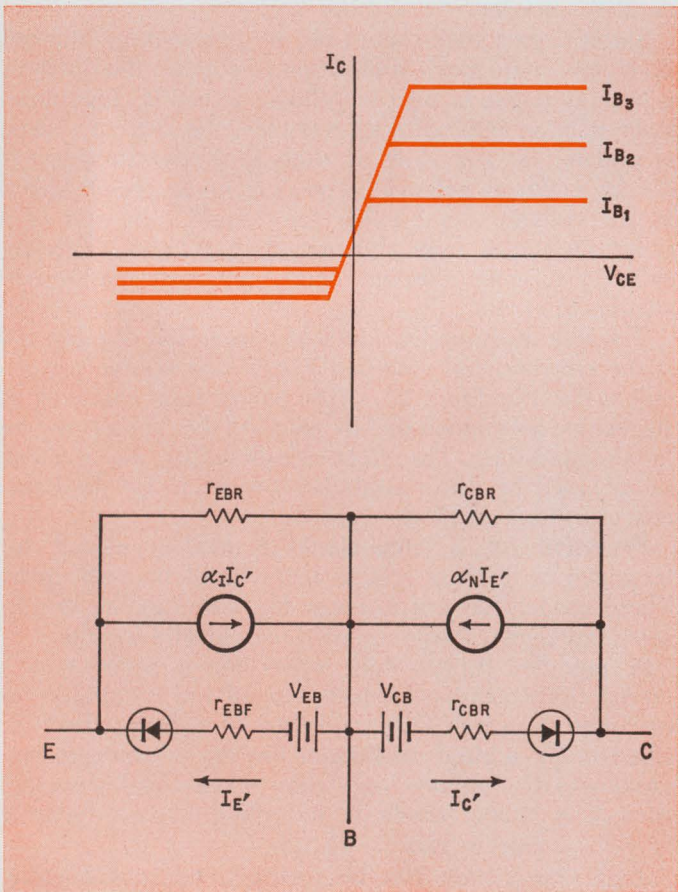

Nonlinear modeling. Piecewise d-c model for a transistor, top, and a simplified form, bottom, are two methods of analyzing the nonlinear behavior of this solid state device.

ical accuracy and simplicity in the program's model.

For very high-speed or high-frequency circuits, lumped models may not predict results accurately; the model should also consider the distributed parameters. This flexibility should be a feature of any good circuit analysis program.

Sceptre is one program that is flexible with regard to discrete models, allowing the designer to determine thermal and fabrication effects on the networks response. In Sceptre the thermal characteristics of the device are represented in tabulated form, rather than as discrete elements. A set of simple small-signal models that could be derived from a large-signal model is very useful for quick analysis. These models could be switched automatically by the computer if it is warranted during the execution of the network analysis program. This speeds the program's running time. ●

Bibliography

- J.J. Ebers and T.L. Moll, "Large Signal Behavior of Junction Transistors," Proc IRE, Vol. 42, December, 1954, pp. 1761-1772.
 R. Beaufoy and J.J. Sparkes, "The Junction Transistor as a Charge Controlled Device," ATE Journal, B, October 1957, pp. 310-327.
 J.G. Linvill, "Models of Transistors and Diodes," McGraw-Hill; New York, 1963.
 D. Koehler, "The Charge-Control Concept in the Form of Equivalent Circuits, Representing a Link Between the Classic Large Diode and Transistor Models," BSTJ, Vol. 56, No. 3, March 1967, pp. 523-576.

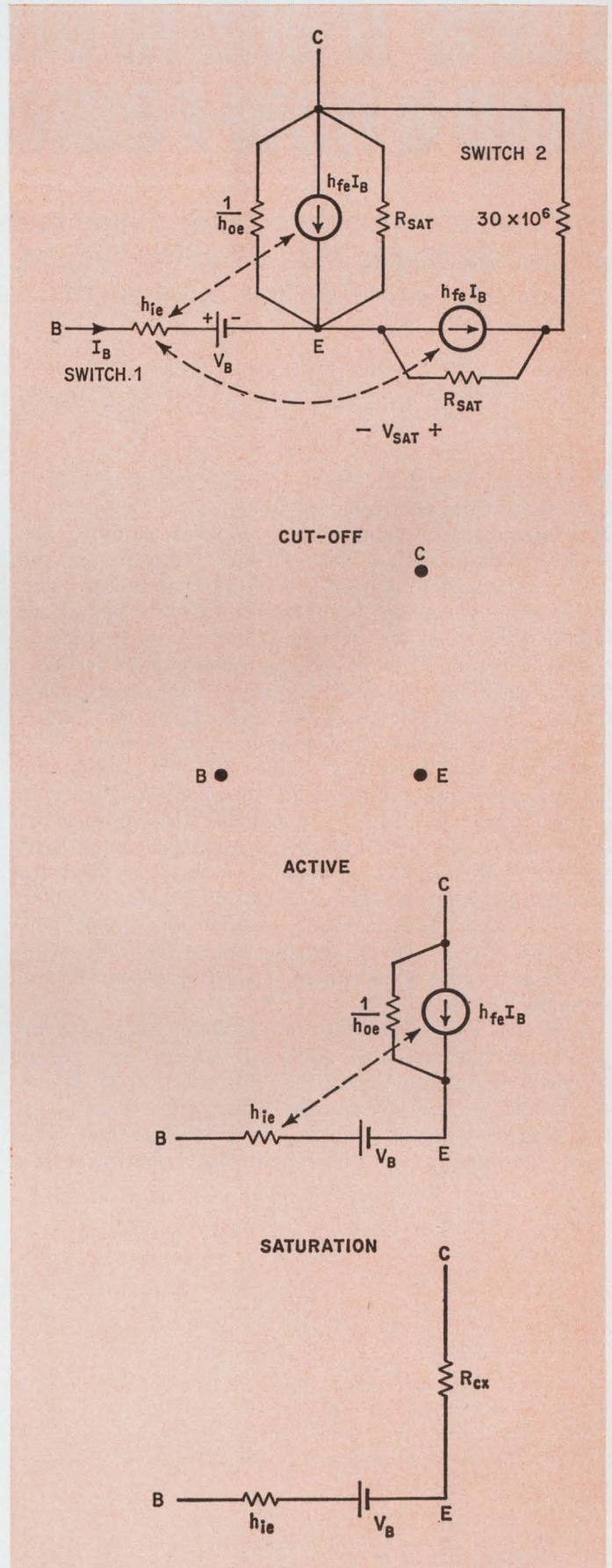

Switching. The three-region model used in ECAP simulates a transistor that changes regions of operation during the analysis. Ideal switch permits the use of a piecewise linear model.

TOPS' trails to outer planets map a new route to reliability

The crucial elements in outer-planet missions that could last from eight to 12 years are an adaptable data-handling system, and a self-testing and repairing computer with triple redundancy in subsystems, says *Alfred Rosenblatt* of *Electronics' staff*

● Although President Nixon only this month approved a mission to the outer planets [*Electronics*, March 16, p. 71], engineers for some time have been studying the requirements of such a "Grand Tour". Long life and the ability to adapt to the effects of internal failures and the space environment probably are the most important factors that must be designed into an outer planets spacecraft. And the Jet Propulsion Laboratory, Pasadena, Calif., has addressed itself for more than a year and a half to these problems in its nuclear-powered TOPS—Thermoelectric Outer Planet Spacecraft—project.

Many at the laboratory feel the TOPS effort, conducted for NASA, will affect not only an outer planets spacecraft, but the design of all future unmanned space probes. An outer planets mission imposes severe constraints, particularly with respect to reliability and the need for automatic operation. These constraints could lead to the most adaptable spacecraft ever developed, with new kinds of subsystems for data handling, fault diagnosis and repair, radio communications, attitude control, and imaging.

Lifetime and adaptability are probably the most important considerations, and will affect the design of all the subsystems more than any other single factor. A Grand Tour will last anywhere from eight to 12 years; the longest planetary mission thus far—to Mars—took only nine months. Insuring reliable operation for such a

long time—100,000 hours is a round figure quoted by JPL engineers—will be a formidable task. A completely automatic fault location and repair system is a must for coping with equipment failures. But another reason for complete automaticity is distance. At Neptune or Pluto, the round-trip communications time between the spacecraft and earth is about eight hours. It would take too long to send data to earth—where calculations would be made to determine such factors as how to circumvent a fault or when to turn on control rockets for a midcourse maneuver—and send commands back to the vehicle.

At the center of the adaptability requirement is the data handling system, shown on page 111. In addition to controlling, collecting and preparing scientific measurements for transmission to earth, the system also keeps track of the engineering data that describe the health of the spacecraft. And it trouble-shoots and locates faults, and makes repair.

Controlling all this activity will be the STAR—for self testing and repairing—computer, an ultra-reliable central control processor, that uses at least triply-redundant subsystems. Using special programs, it will locate faults and perform maintenance chores on just about every subsystem in the TOPS spacecraft, including itself. The central data system also will have a computer-accessed telemetry system (CATS), which controls sampling of scientific and engineering data; a data storage system made up of a buffer memory, bulk-storage tape, and a read/write memory that's shared between the central STAR computer and the telemetry system; and a central source for all clock timing within the spacecraft's electronics. The CATS will operate from a 2-megahertz clock; STAR will be slower, at about 100 kilohertz.

This is the current design approach, says Benn D. Martin, in charge of developing the central data system, and he emphasizes the word current. "The only sure thing is that it will change." But JPL hopes to have major portions of the system breadboarded and "playing in the laboratory" within 18 months.

The system is a more centralized approach to data handling than JPL has ever attempted, Martin says, adding that "people were afraid to put all their eggs in one basket." By doing so, "we're able to combine similar functions and implement the entire system with fewer components. Then we can add redundancy selec-

Contender. Fourteen-foot unfurlable antenna dominates one possible configuration for a Thermoelectric Outer Planet Spacecraft considered at JPL. Radioisotope thermoelectric power generators are out on a boom to reduce effects of their radiation. Their heat may be piped in to ameliorate the extremely cold temperature the spacecraft will encounter in deep space. Some of the experiments that could be included on a TOPS craft have been indicated, but no decision has been made about which will fly.

tively, where we really need it.”

Sharing a memory between the central control processor and the telemetry system also is a spacecraft first. It's a necessity: if STAR is to trouble-shoot, it needs to have access to what's going on everywhere in the spacecraft. Data storage ability contemplated for the data handling system in addition to the shared memory is prodigious. A semiconductor buffer will store 8 million bits; another memory system, probably a tape unit, will hold 2 billion bits.

The CATS system does more than just acquire measurements. It also can process the measurements, comparing them to critical health or activity levels that are stored in its memory. When any fall out of their allowable tolerances, CATS can alert the STAR computer to perform program routines for diagnosis and location of the fault. And if CATS should fail, STAR also will be able to control the telemetering, although at a slower rate.

It also will be possible for STAR to reprogram the telemetry system and change the sequence and rate at which it scans the scientific and housekeeping sensors via programs brought in through the shared memory. This might be needed in critical mission situations—for example, when the spacecraft enters a radiation belt and certain measurements must be taken more often.

Each scientific instrument will have its own interface unit with the digital telemetry system. Relying on signals from the central telemetry system, the interface unit will also control the instrument's measurement procedure. And the unit also could store certain measurement results.

Rather than a hard-wired commutator, the telemetry system will have a binary tree switch, operated at a 20-Khz rate, to connect to the analog inputs. This could be random-addressable, allowing any input to be sampled simply by changing a control word in the telemetry processor. Built with field effect transistors, the commutator could be made more reliable by selectively paralleling the more critical switches. Completely redundant paths for a particularly important measurement could be provided by connecting the critical sensor to both its binary and complement addresses.

The STAR computer shown on page 112 could be the single most important element in the TOPS system design. STAR is an experimental computer which came

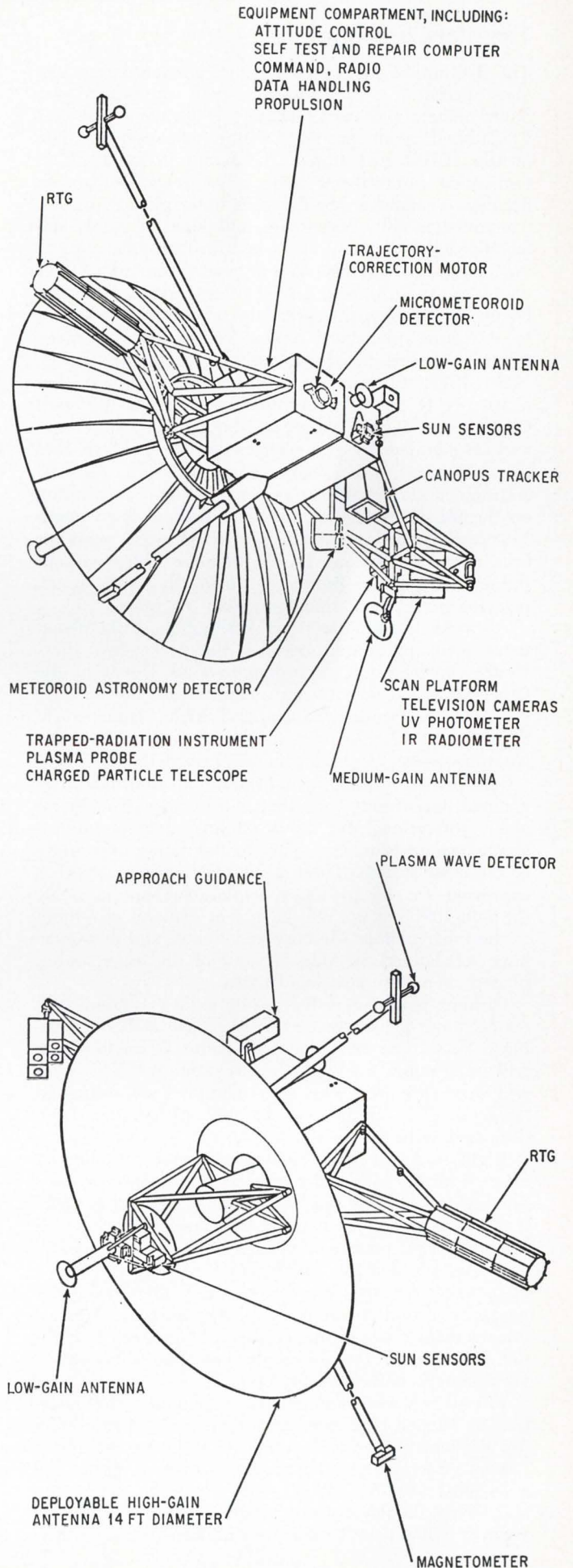

The stars are right

The decision to focus research and advanced development tasks on a ballistic spacecraft mission to the outer planets was made in July, 1968 at JPL. It was the advantageous position of the outer planets late in the 1970's that tipped the scales in favor of an unmanned, multiplanet flyby, says JPL's William S. Shipley, co-manager for the TOPS outer planets project. The mission will "coordinate individual research and advanced development tasks and will provide a focus that lends an identity to the work," he adds. This decision was fortuitous, indeed—it anticipated President Nixon's announcement earlier this month that a mission to the outer planets is a goal of the nation's space program for this decade [*Electronics*, March 16, p. 71].

By 1977, the planets will be positioned so that a spacecraft aimed at Jupiter by a Titan 3D with Centaur and Burner stages will have its course altered and accelerated by the planet's gravity field so that it could reach other outer planets—Saturn, Uranus, Neptune and Pluto—in a reasonable time. Depending on the mission this time ranges anywhere from about 7½ years for a three-planet tour to almost 12 years for four planets. Missions to Neptune or Pluto without the gravity assist of Jupiter, but using the same launch vehicle, would take something like 30 years.

At NASA headquarters in Washington, three-planet tours seem preferable because they take less time. Under consideration, according to Paul Tarver of the Office of Space Science and Applications, are an 8½-year tour to Jupiter, Saturn and Pluto, launched in September 1977, and a nine-year Jupiter—Uranus—Neptune junket beginning in November 1979.

The planetary alignment presents an unusual astronomical opportunity, one that will not occur again for about 180 years. And it has stimulated great interest among scientists seeking clues to the nature and origin of the solar system. These goals match those NASA has expressed for its planetary exploration program. By the mid-1970's, NASA will have sent exploratory probes to the inner planets Mercury and Venus, and may even have soft-landed on Mars. A tour of the other, outer, planets seems the next logical step.

Current planning is for a \$10 million funded start on an outer-planet spacecraft in fiscal 1972, according to NASA director Thomas O. Paine. A single center will be selected to direct the program. But how NASA will meet the total cost of a Grand Tour—estimated between \$500 million to \$1 billion—has not been discussed publicly.

Right now, though, there's no "special TOPS budget or centralized billing for money that's spent," JPL's Shipley is quick to point out. Rather, the TOPS tasks involve research and advanced development work which in the normal course of events would be undertaken anyway, says Rob Roy McDonald Jr., who, as Shipley's co-manager on TOPS, coordinates the various tasks that could be useful to an outer planets mission. Normal management channels are responsible for each individual task, and McDonald emphasizes that "the existing management authority stays put."

But all this will undoubtedly change once the outer-planets mission is pursued as a flight project. JPL director William Pickering is understood to be making a "major effort to get the program," according to one NASA observer. But other centers will be competing and "even though TOPS is totally at JPL, this doesn't mean it will get the Grand Tour mission," says another.

to JPL as an idea in the mind of Algirdas Avizienis when he joined the laboratory in 1961. Avizienis describes his brainchild as "really imitating the job a skilled technician would do if he were along on the spacecraft." And although STAR began as a research program—a first breadboard only began working last year—Avizienis says "we're happy to find a use for it."

But Avizienis also predicts STAR will find many other applications. Its highly reliable organization and its ability to repair itself can be useful in monitoring equipment in intensive care hospital wards and in instrument landing systems.

The STAR computer could keep track of just about everything in the TOPS including the electronic systems performing the communications, guidance, scientific, and data handling chores, and the propulsion system as well. The computer could determine, by sensing engine temperatures and pressures, whether an engine burn is proceeding as planned. If these parameters fall out of preset limits, the engine could be turned off before the spacecraft is hopelessly out of position. The system would record what took place, call in a new program, and either try to reorient the spacecraft or send messages to earth and wait for instructions. This is done "as a matter of course at Cape Kennedy," points out Avizienis, "and now it will be able to be done in space."

The functional units of a STAR computer may be thought of as a collection of small special units in triplicate, tied together by two information busses, says Avizienis, the memory-in bus and the memory-out bus. Thirty-two-bit computer words are transmitted on these busses in bytes of four bits. Error-detection is done with multiply-by-15 code [*Electronics*, Sept. 4, 1967, p. 41].

As instruction words appear on the busses, each unit samples the operation code and performs the required operation. The test and repair processor (TARP) is the "hard core" of the system, serving as a central controller and as the fault-diagnosis unit for both the computer and the other spacecraft systems. Three identical TARP units are always fully powered and operating; there are partially powered standby spares as well. All outputs are decided by majority threshold voting. When one powered TARP disagrees with a voted output, it is returned to its standby condition, and one of the spare units is turned on.

When a fault is diagnosed and located in a computer unit, the TARP commands the unit to be replaced by switching off the faulty unit's input power and switching power to the next spare. A special magnetic power switch, designed to fail open, is part of each unit's power supply.

At present, JPL has been testing a basic STAR consisting of a central test and repair processor, two read-write memories, and a braided-wire read-only memory, main arithmetic processor, a logic processor that performs logic operations on data words, and a control processor that contains the location counter and index registers. The input/output devices are a typewriter and a card reader.

Furthermore, work is progressing on assembling a computer with a complete set of subsystems, to be followed by exhaustive testing to see how faults are picked up, or, as Avizienis puts it, "to see how the machine actually behaves when it's hurt." Both permanent and transient faults, detectable through the system's coding scheme, will be inserted. When a transient fault is caught, the computer program will be restarted far enough back to produce good data again. Avizienis says the test program could go on for as long as two years, but while it's in progress he'll begin incorporating what's learned into an advanced computer design, a sort of "super-STAR."

But the "greatest and most challenging job" Avizienis faces has nothing to do with the computer design—it's "acquainting every engineer working on the TOPS program with the feasibility of automatic maintenance," and to get them "to design their electronics to be maintainable." He'd like to see the engineers write diagnostic programs for their equipment as they design it.

As for applying STAR, Avizienis says it will have to be scaled down for an outer-planets mission because "it's too general purpose now." TOPS may not, for example, need all of the computer's arithmetic ability. And the number of memory modules could be adjusted for a particular mission—up to the STAR's capacity of 65,000, 32-bit words in 4,096-word modules. Fortunately, STAR is a "complex machine" which can be made simpler by pulling things off, Avizienis points out; it doesn't have to be designed upward.

STAR will, at the very least, be built with medium-scale IC's. And JPL has a pilot contract with Radiation Inc. to produce four basic bipolar IC's from which, it's hoped, some 80% of the computer's logic could be built.

There's actually no hard design of the spacecraft; the configuration keeps changing as ideas are developed. However, it's likely to look "like it's mostly all antenna," says Rob Roy McDonald Jr., a TOPS project manager, referring to a 14-foot-diameter parabolic dish, as shown on page 109, that will be unfurled once the TOPS is out in space. And the spacecraft will weigh between 1,200 and 1,300 pounds. The dish has a Cassegranian feed and its central portion is a fixed structure, rather than unfurlable. Such a construction may, it's thought, yield better control of the dish's focal point, and make it easier to maintain the dish's orientation with respect to the feed. The nuclear power source—four radioisotope thermoelectric generators supplying 440 watts by the mission's end—are placed to produce the least radiation within the space vehicle.

The earth orientation of the spacecraft's antenna also will have to be carefully maintained to ensure proper transmission of scientific and engineering, or housekeeping, information to the tracking stations on earth. And a stable platform on the spacecraft will have an imaging system to take pictures of the planets as the vehicle flies by. Both of these capabilities require a stabilized spacecraft. From among three possible candidates for

Nerve center. Basic and preliminary design of TOPS' central data system shows the self testing and repairing (STAR) control processor and the telemetry system sharing a read/write memory. Buffer memory is likely to be a semiconductor unit. The size of the mass store, however, could dictate a tape recorder, although its moving parts are undesirable.

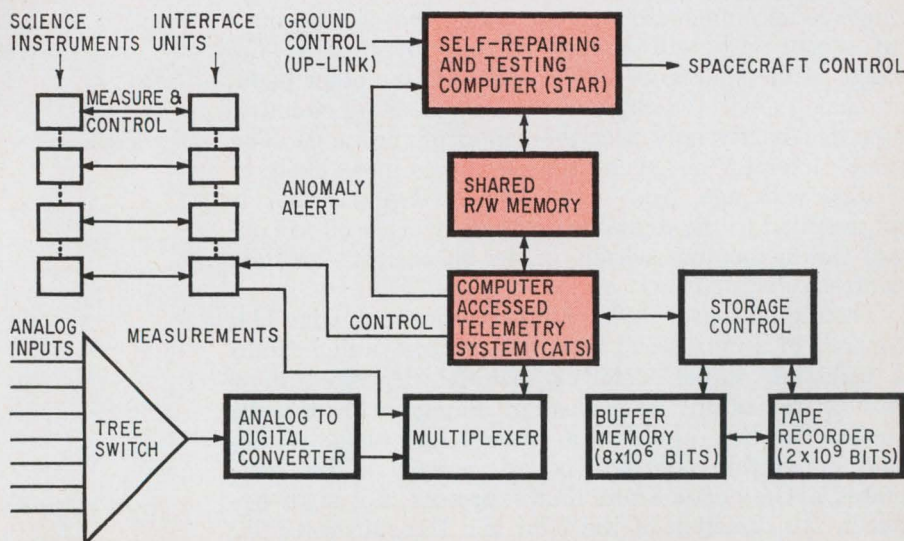

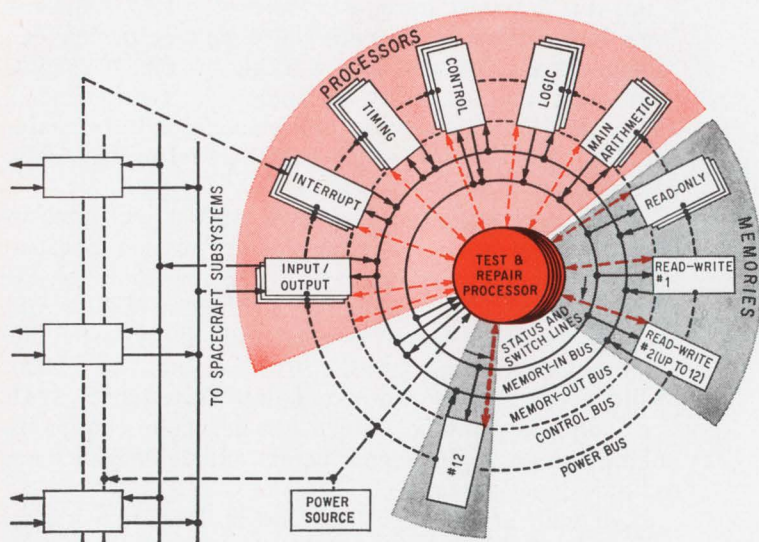

The pilot. The central test and repair processor in the STAR computer will direct control and maintenance of all subsystems aboard an outer planets spacecraft, and isolate faults and repair itself. The TARP consists of three identical majority voting units and standby spares. All other parts of the computer, which JPL is designing for a 90% probability of lasting 15 years, are at least triply redundant. On an actual mission, the computer in a spacecraft could be simpler than the complete system shown here.

an attitude stabilization system—three-axis, dual-spin or spin stabilized, and gas stabilization—JPL chose a system stabilized about three axes, according to W.E. Dorroh Jr., senior engineer on TOPS' attitude control system. The gas stabilization system was quickly rejected because even if enough gas could be put aboard, control valves would require too many actuations to operate reliably over the life of the mission.

The spin-stabilized and three-axis-stabilization systems actually offered nearly identical tradeoffs with respect to weight, power and longevity. Tipping the scales in favor of three-axis stabilization probably was JPL's long experience with this kind of system. Ranger, Surveyor, Lunar Orbiter, and Mariner systems managed by JPL all used it. On each axis, gas jets and a reaction wheel (with a standby spare) will be used to control the spacecraft's attitude.

To provide the reference for accurately pointing the spacecraft's 14-foot-antenna at earth, JPL is developing a sun sensor that produces digital signals using a mosaic of photoconductive material. The sensor's signals are used to control an electrical bias on the reaction wheels so that the spacecraft is positioned to point the antenna at earth.

A digital, rather than an analog, device was selected for several reasons. First, the digital sensor will operate independent of the sun's intensity, which, during the mission, will vary over a range of 900 to 1, a large range to accommodate with an analog sensor. The digital sensor also will operate linearly over $\pm 15^\circ$ —the range of the spacecraft's yaw angle. On the other hand, an analog device would, without compensating circuitry, operate linearly only near the center of the range. The scale factor for an analog device also is more likely to change with age. And, in addition, a digital sensor is more suited to the digital techniques being used to control the momentum wheels in the spacecraft's attitude control subsystem.

The digital sensor in development, shown on page 114, consists of a cylindrical lens that focuses sunlight onto a cadmium sulfide detector material deposited in a Gray code pattern on a glass or aluminum oxide substrate. The lens produces a straight line image of the sun across the detector's coded segments. This generates a Gray-code word that expresses the angle between the direction of the light and the substrate. JPL

now is working on an 8-bit sensor to be used on the pitch axis of the TOPS-mission spacecraft, according to Louis Schmidt, director of the sun sensor development. (An 11-bit device is expected to be built later for the yaw axis. Roll will be controlled by a Canopus star tracker similar to the Mariner's but with improved-life-time.)

By using additional coded segments to produce a vernier-like effect on the least significant bit it's possible to detect angular changes as small as $.025^\circ$, with JPL shooting for a total allowable position deadband of $.05^\circ$, Schmidt says.

In the sun sensor, the cadmium sulfide is used in a photoconductive mode so that the Gray-code segments change from very high to very low resistance as the line of sun light sweeps across them. In each digit line, the light-sensitive material is arranged in a series of horizontal sandwiches in which ± 5 -volt supply busses are the bread; cadmium sulfide segments—one of which begins precisely at the line where the other ends—provide two layers of lettuce; and an output signal electrode in the middle represents the meat. Which segment of cadmium sulfide is shorted to switch either the $+5$ -volt or -5 -volt supply line to the signal line depends on the position of the light. And the result, with a complete sensor mosaic, is a readout of the sun line's position in a binary Gray code.

However, there's a problem—the switch between the two supply voltage levels when the light moves from one cadmium sulfide line to the other does not occur instantaneously. There's a transition region during which the output signal voltage passes through zero. This zero-crossing point is detected by a hysteresis switching amplifier, which is buffered by a high-input impedance operational amplifier in a voltage follower mode.

Output from each sensor line, then, is a 1 or 0 regardless of light intensity. The light-sensitive material is used merely as a switch. It does not produce an output current as silicon light sensors do when operated in a photovoltaic mode.

JPL has built four 8-bit sensors using a recrystallized, thin-film cadmium sulfide on half-inch-square aluminum oxide substrates, according to Schmidt. The recrystallization process represents a "new art," he says. The cadmium sulfide is vapor-deposited, then heat-treated and doped with copper, resulting in an extremely uniform multicrystalline material.

Of the many types of experiments under consideration for a TOPS mission, an imaging system—one that will send back pictures of the surfaces of the planets—will probably spark the most interest among scientists and layman. But although different types of dielectric tape cameras and slow-scan vidicons are being eyed, JPL's Allan Eisenman, says "we'll probably have a lot of de-

velopment to do before we get the sensor we want." Eisenman, a senior engineer working in TOPS' scientific imaging effort, sees no one sensor combining the high sensitivity and lifetime that will be needed. The sensor's resolution cannot be specified yet because it involves tradeoffs with the focal length of the lens. This, in turn, is affected by how closely the TOPS flies by each planet. However, focal lengths could range anywhere from one to four meters, with apertures up to 200 millimeters, says Eisenman. And he cites six miles as a ball park figure for the desired resolution of objects on the planets' surfaces.

The further away the spacecraft travels from the sun, the more sensitive the imaging sensor must be. Light level at Jupiter is 200 foot-lamberts, for example, but out at Pluto, it's only 1.6 foot-lamberts, low enough to give Eisenman pause about operating in the sensor's photoelectron-noise-limited region. Large flyby velocities also may smear the image produced on the sensor if the shutter is opened for too long.

Dielectric tape cameras have been developed for the military by RCA and Westinghouse, and CBS is working on its own system. However, each of these systems are "basically unproven" for space flight, Eisenman says.

Dielectric tape cameras offer a significant advantage—they permanently store an image as they sense it; a separate videotape recorder is not needed to store the image until it can be transmitted to earth. The image, which is first focused on a layer of photosensitive material, is stored in the form of charge patterns on the dielectric tape, made of silicon dioxide or polystyrene. Then the tape is read out directly by an electron beam.

Among the vidicons under consideration, tubes with arrays of silicon diodes are getting special attention because of their ruggedness and long life. Both types of silicon mosaic tubes are under consideration—those in which light is imaged directly on the silicon, and the more sensitive type in which electrons, first produced by light striking a photocathode, are accelerated and focused on the mosaic array.

High-resolution film cameras, with a film scan system similar to the one carried aboard the lunar orbiter, were considered—and rejected. Film is particularly susceptible to radiation, and both the film and the film-processing chemicals are too short-lived.

Slow scan rates will be needed with any sensor be-

Lined up. For Grand Tour missions later in the 1970's, the planets will be in position so that Jupiter deflects and accelerates a spacecraft moving towards the other bodies.

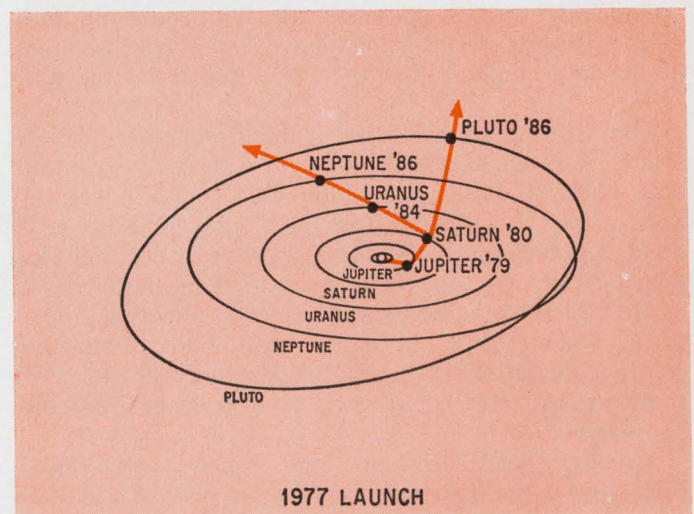

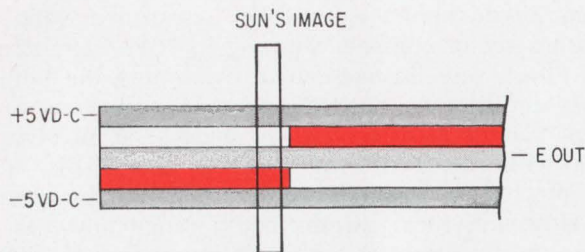

Sun's image. Digital sun sensor, using coded cadmium sulfide segments (in color above and at right), produces a binary-word equivalent of the sun's angular position (shown for five bits). Five-volt supply voltages can be converted to the TOPS system's logic levels in the switching amplifiers.

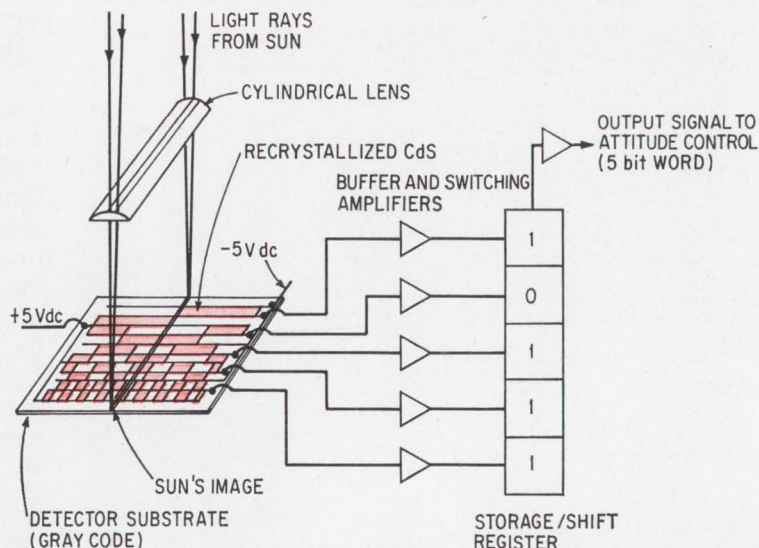

cause of the slower speeds of the buffer circuits and tape recorder, and the limited transmission rate to earth, points out Eisenman. For example, at a rate from Jupiter of 130,000 bits per second allowed by the transmitter power, it might take 40 seconds to transmit a frame. Frame rates may range anywhere from 2 to 60 seconds and the sensor should retain an image for comparable periods.

Although a silicon vidicon tube generally has limited storage ability, image storage time increases as the silicon is cooled, Eisenman observes. At -40°C , frame times could be as long as 40 seconds. And it also may be possible, asserts Eisenman, to retain an image on the silicon dioxide layer that covers the array of silicon diodes.

Right now, JPL is buying and characterizing a variety of vidicons. JPL wants a specification for a "baseline" imaging system by June. And according to Eisenman, the specification may ask for more than one type of sensor.

There'll be a second imaging system aboard a TOPS to provide guidance as the craft swings by each planet. Approach guidance would have to be done automatically—there would be no time to wait for commands from earth. Such an optical guidance system would view the location of the stars and any satellites of a target planet to determine the spacecraft's trajectory. Mid-course maneuvers would be controlled by the on-board computer. This optical guidance function could be integrated with the scientific imaging system, says Eisenman, fitting on a single, rather than on separate, stable platform.

The TOPS craft will have a dual-frequency r-f subsystem for sending the pictures and other scientific data back to earth. It will be able to both transmit and receive on S-band links and transmit-only on X band. The latter link will be used primarily for dumping data quickly to the deep-space tracking network on earth. TOPS also will have a pulse-code modulated command system using all-digital logic, built around recently available 256-bit metal oxide semiconductor shift registers. Bit rates could range from 4 up to 1,000 bits per second.

Although satellites have used X-band communications, this is the first time the frequency will be used in a spacecraft, points out Alden Galbreath, who's in charge

of the r-f subsystem for TOPS. The S-band links will be used for sending command and control information, for Doppler tracking, and for determining range to the spacecraft.

Right now, the most likely candidates for both the S- and X-band power generators are those old standbys, traveling wave tubes. JPL is looking at available solid state devices, particularly at S-band. And the laboratory is working at improving materials for twt cathodes and electron guns.

The available power from the nuclear power source will, of course, be at a maximum early in the mission and decrease with time. JPL may develop an X-band transmitter with dual-level outputs of 20 and either 40 or 50 watts. At the higher level, information could be transmitted from Jupiter at a 130,000-bits-per-second rate to be received by tracking stations using 210-ft antennas.

JPL is working hard at extending the twt's lifetime. One approach is to develop a single tube with more than one electron gun, says Galbreath. In one mockup of such a multiple electron gun, eight guns are mounted radially around a turret. Each gun can be switched so that its axis is in line with the axis of the rest of the twt. A thermostatic motor rotates the turret and changes the gun that's supplying electrons to the tube. Galbreath feels it may be possible, with the electron guns and the

twt all under a vacuum seal, to position each gun to better than one mil, yielding "good" performance.

For the long life that's required, the traveling wave tube will be the weakest link in the radio subsystem design. Emission from the cathode decreases with time—the cathode "wears out" or it gets poisoned by impurities, according to James Boreham who's charged with developing the spacecraft's receivers. The longest-lived tube under test at JPL—a 10-watt unit—has lasted more than 40,000 hours, he says, indicating that 25,000 to 35,000 hours of life could be expected in space, far short of the 100,000-hour-life desired.

But going to a more reliable solid state device may not be the answer. Although enough power can be obtained at S-band, the efficiency with which d-c power is converted to r-f is still too low, Boreham says. "The r-f transmitter is a big user of electrical power," he points out, "and we must eke out all the efficiency we can get. Even a few percentage points are important."

The figures for Mariner 69 illustrates how much power is lost in the r-f transmitter. For an output r-f energy of 20 watts, the twt transmitter required 95 watts of d-c power, an efficiency of 21%. For the TOPS design, JPL wants 20 watts of output power at S-band, but at an efficiency of at least 40% says Boreham. Chances are that only a twt will provide this.

The r-f subsystem designers also will take a hard look at the circuits they've used in the past. JPL essentially has been using the same circuits developed for the first Mariner mission in 1964.

The major task over the next few months is to identify the circuitry that needs improving and redesign it, circuit by circuit, says Galbreath. The circuits and block diagram must be thoroughly simplified. "The transponder will be one of the first elements we'll try to simplify," he says. "We'll be looking at such things as voltage-controlled oscillators, video amplifiers, mixers and i-f strips. When we have these, we'll be able to consider the redundancy we'll need," he adds.

For a mission lasting as long as a Grand Tour, an entirely new method of achieving reliability must be developed, according to JPL's Thomas R. Gavin, TOPS' reliability expert. New test techniques will be needed for the medium- and large-scale integrated circuitry that may be used; it won't be possible to apply the piecemeal reliability techniques used up to now. "We learned

a lot from handling Minuteman parts," says Gavin, "but when we tried to apply these screening techniques to IC's, they just weren't adequate."

Until Mariner 69, Gavin says, reliability techniques applied to discrete components resulted in zero failures after launch and hardly any pre-launch failures (those that occur after equipment has been assembled and while it's being tested). When IC's were first introduced on Mariner 69, there were 100 pre-launch failures among the 2,500 or so IC's, according to Gavin. And there was at least one, and possibly two, failures in flight.

Basically the piece-parts test methods applied to IC's made input and output tests of each circuit. This was inadequate, Gavin says, because it didn't provide any information about what was actually happening to the individual circuits within the semiconductor chip. Needed are better understanding of the failure modes within an IC chip and a knowledge of how to detect them. New manufacturing techniques will be developed. (Radiation Inc., for example, is using a double-photoresist process to eliminate pin holes in the metallization on the IC's they're developing for the central computer.)

Of course, it won't be possible to test all of the circuits within an IC chip. But sampling techniques could be developed that would give a better insight into what's happening, according to Gavin. One idea, being pursued by Philco Ford, is to put special test patterns on each wafer. It also might be possible at least to check the most critical modes in which an IC subsystem must operate, and to ascertain at the chip level that all logic states are operating.

Gavin reports JPL wants more reliable integrated circuit packages, whose materials will be more compatible with silicon. And the effects of radiation on integrated circuitry also will be carefully studied. Much of the military effort aimed at developing radiation-resistant circuitry considered high energy, short-duration pulses, Gavin points out. The problem for a TOPS mission, proceeding, for example, through the radiation belts around Jupiter, is low energy radiation which lasts for long periods of time. Hardening or shielding the circuits also is being studied.

With respect to MOS devices, Gavin says engineers are convinced MOS will continue to be more susceptible to radiation than bipolar devices.

In assessing the types of technology that eventually might be used aboard a spacecraft making a Grand Tour, one JPL engineer points out that the lab "doesn't have the time or money to go too far out," adding that "we might even fly the technology on an earlier mission."

Benn Martin brings up another consideration, tied to the longevity required of the outer-planet system. "We'd want to have a test time that's somehow proportional to the lifetime of the mission," he says "so we'd want more time than is usual to investigate degradation and performance trends in whatever technology we used." And the great complexity of the craft's electronics would make desirable even more test time. Estimates are that the technologies selected might have to reach a proven status or be "technically mature" by the end of fiscal year 1972 or 1973, providing at least a four-year lead time until the initial launch. In contrast, for earlier Mariner flights only two to three years elapsed between the time technologies were selected and the design frozen, and the actual launch. ●

Synchro-to-digital converters: Pick the one that fits the job

Trackers handle high angular velocities; samplers respond to step changes; *Frederick Roberts* of North Atlantic Industries, Plainview, N. Y., examines operating characteristics and virtues of each type

● **It spins;** maybe it's an antenna, or part of an aircraft simulator, or a positioning arm in an integrated-circuit handler or a machine tool. Regardless of its job, if you want to control this rotating shaft with a computer, monitor its angular displacement with a digital meter, or record its movements with a data-logging setup, you need a synchro- or a resolver-to-digital converter.

A synchro and a resolver are basically the same; each is a rotary transformer that converts the angular displacement of a shaft coupled to the transformer's shaft into a set of sinusoidal signals. The devices differ in that a synchro has three secondaries connected in a Y, and thus has three output leads, while a resolver has two secondaries which aren't connected to each other, and thus has four output leads. A resolver-to-digital converter turns the two sine waves coming from a resolver into a digital signal. A synchro-to-digital converter comprises a resolver-to-digital converter along with an input network that transforms the three-wire data of a synchro into the four-wire data of a resolver. Since this input network is all that sets a synchro converter apart from a resolver unit, anything true about one type holds for the other.

Classed according to how they digitize, converters come in two varieties; one samples its sinusoidal inputs and periodically converts, while the other tracks its inputs and continuously converts. Once you know how

accurate your measurement should be, what the shaft's top angular velocity is, how distorted the analog inputs are, and whether you're multiplexing, it's clear which type you should pick.

In general, if you want better than 10-bit, or 0.35°, accuracy, if the shaft's velocity is higher than 45 revolutions per minute (270°/second), or if the inputs are distorted by noise or harmonics, take the tracking converter. Base prices for tracking and sampling converters of the same accuracy are about equal, starting at less than \$1,000. A high-accuracy (17-bit) tracking converter with a display goes for \$6,000. A sampling converter responds more quickly to step changes in the shaft's angular displacement. This explains why sampling converters lend themselves to multiplexed systems where many channels of analog data are going to a single converter; switching a channel of synchro or resolver signals to the converter's input is equivalent to applying a step function. However, when there are many shafts, all with high angular velocities or all whose angular displacements are to be measured to a high accuracy, it's necessary to connect each shaft to its own tracking converter, and then multiplex the digital outputs of the converters.

This converter selection process all sounds simple, but it's not unless you understand the types of errors inherent in the tracking and the sampling converters,

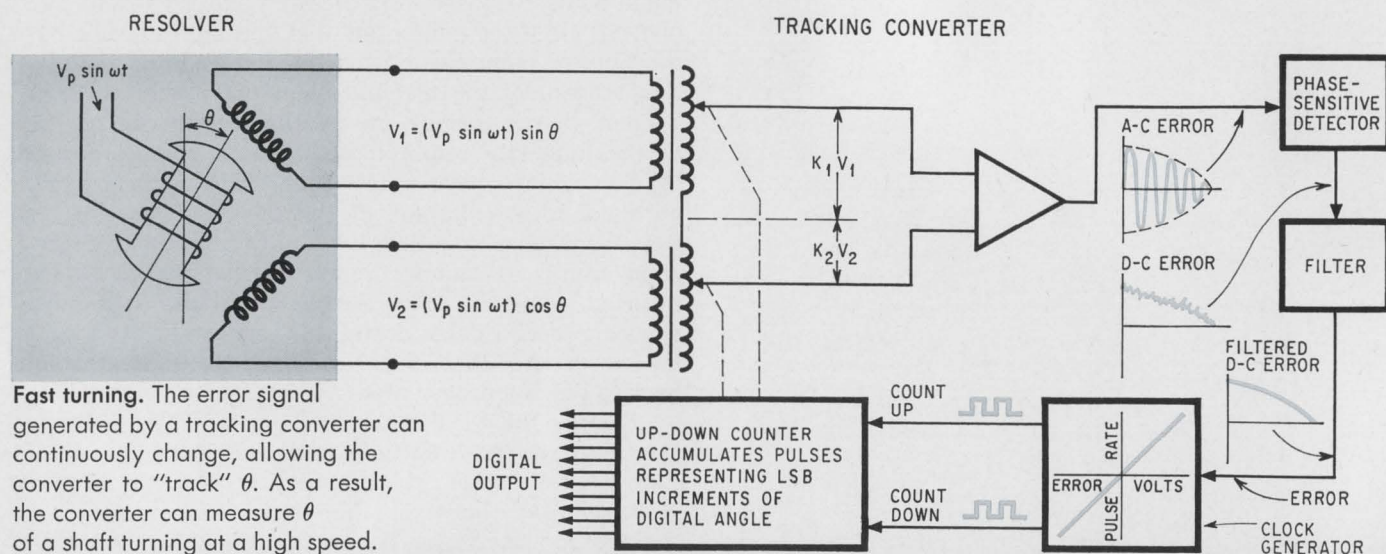

Fast turning. The error signal generated by a tracking converter can continuously change, allowing the converter to "track" θ . As a result, the converter can measure θ of a shaft turning at a high speed.

or inductive, and each has a row of output taps. Coming from the dividers are voltages equal to K_1V_1 and K_2V_2 , where K_1 and K_2 are numbers between 0 and 1 whose values depend on from which divider taps the two outputs are being taken.

A summing amplifier subtracts K_2V_2 from K_1V_1 , generating an error voltage, which is zero whenever K_1V_1 equals K_2V_2 . In this case the shaft's angular displacement is given by

$$\theta = \tan^{-1} (K_2/K_1)$$

For the tracking converter, finding θ is simply a matter of noting which output taps are selected to reduce the error voltage to zero. It does this by feeding back the error voltage to a switching network that steps through the two sets of taps looking for the null settings.

At the summing amplifier's output is a phase-sensitive detector, which, besides changing the error voltage from a modulated sine wave into a d-c signal, removes harmonics and quadrature components. The detector's output goes to a clock generator, which puts out a pulse train whose repetition rate rises and falls with the error voltage's level. The pulses go both to an up/down counter and to the switching network.

Consider the case where the shaft being monitored is at rest, displaced from some reference radius by θ_1 ; the error voltage is zero, and the converter's display reads θ_1 . If the shaft moves through an angle, θ_2 , the error voltage jumps to some value, positive if θ_2 is positive, and negative if θ_2 is negative. The error voltage turns on the clock generator; out comes a pulse train. As the converter's switching circuit adjusts the dividers closer to their null settings, the error voltage drops and the repetition rate drops with it. When the voltage hits zero, the counter turns the number of pulses it has received into a digital signal that goes both to an output register and to the display, which reads $(\theta_1 + \theta_2)$.

Unlike tracking converters, which are less than 10 years old, sampling converters have been around as long as digital systems themselves. As a result, there are a large number of proprietary designs used by various manufacturers to process data samples. Nonetheless, most peak-sampling, or simply sampling, converters follow the same principles as tracking units. Some sampling devices use successive approximation, but their cost and performance are equivalent to those

and the key limitations of each type.

To understand how converters work, first look at a resolver. Its primary is mounted on a shaft, which is coupled to and rotates with the shaft whose angular displacement is to be measured. A sinusoidal voltage, $V_p \sin \omega t$, excites the primary; as the shaft being monitored rotates, the amplitudes of the voltages, V_1 and V_2 , induced in the secondaries rise and fall. Because they're mounted 90° apart on the resolver's stator, the two secondaries produce sine and cosine amplitude responses respectively to changes in the shaft's angular position. In other words, the outputs of the secondaries are

$$V_1 = [V_p \sin (\omega t)] \sin \theta$$

and

$$V_2 = [V_p \sin (\omega t)] \cos \theta$$

where

θ = the shaft's angular displacement.

Finding θ is then just a matter of measuring the ratio of V_1 and V_2 since

$$\theta = \tan^{-1} (V_1/V_2)$$

Converters, in effect, measure this ratio, calculate its arc tangent, and digitize it. Tracking and sampling units go about this procedure in slightly different ways.

A tracking converter has two dividers at its input, one for V_1 and the other for V_2 . They may be either resistive

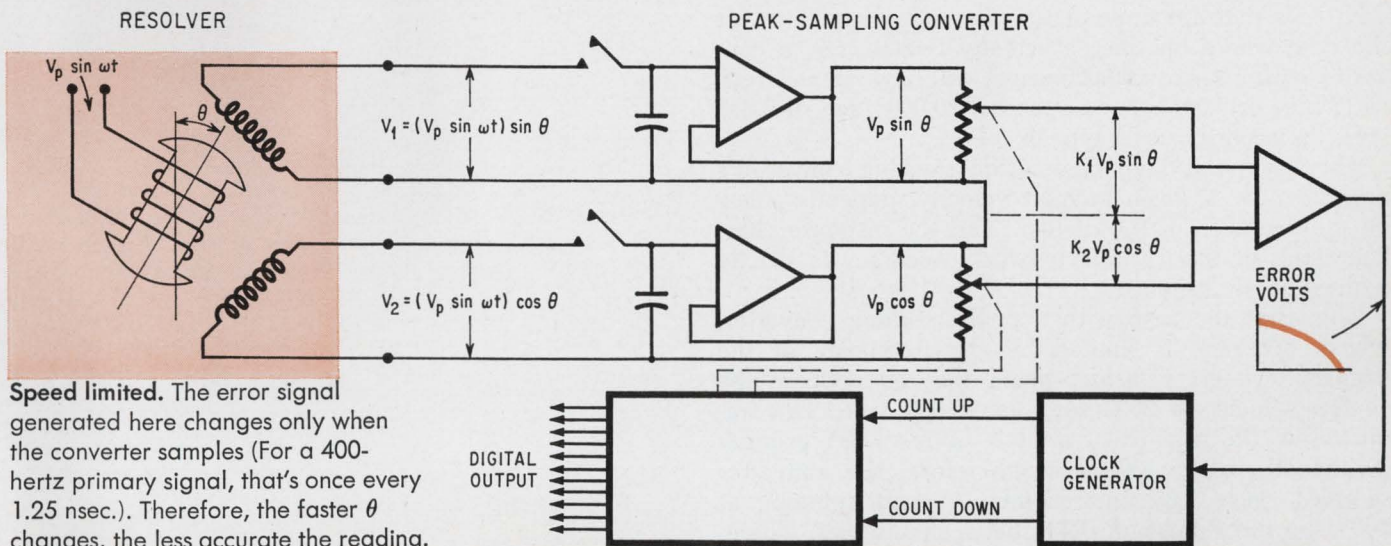

Speed limited. The error signal generated here changes only when the converter samples (For a 400-hertz primary signal, that's once every 1.25 nsec.). Therefore, the faster θ changes, the less accurate the reading.

that use a d-c tracking loop.

The layout of a peak-sampling converter is almost identical to the one just described for a tracking model. An amplifier generates an error voltage which goes to a counter controlling a switching network. The difference is that before going to the dividers, the resolver voltages, V_1 and V_2 , each pass through a sample-and-hold circuit. This consists of a switch, followed by a capacitor in parallel with and an amplifier in series with the input terminals. A control network closes and opens the two switches each time $V_p (\sin \omega t)$ peaks.

The outputs from the sample-and-hold circuits are $V_p \sin \theta$ and $V_p \cos \theta$, d-c signals whose amplitudes depend only on the shaft angle. The signals go to the dividers, whose outputs are $K_1 V_p \sin \theta$ and $K_2 V_p \cos \theta$. A summing amplifier subtracts the two, producing a d-c error voltage, which goes straight to the clock generator. No rectifiers or filters are needed.

The difference between the two types of converters lies in the way each generates the d-c error voltage needed to drive its switching network. The tracking converter generates an a-c error voltage and then rectifies it; the sampling converter turns its inputs into d-c signals before the inputs get to the summing amplifier.

Comparing tracking converters with sampling converters means looking at three questions: What limits the dynamic accuracy of each type; how well does each type handle distortion, and how well does each type perform in a multiplexed system?

Dynamic accuracy is a measure of how fast an angular velocity a converter can follow. It's determined in a tracking converter by the unit's velocity constant, K_V , which tells by how much the converter's output must lag its input in order to generate an error voltage large enough to be sensed by the summing amplifier. K_V is defined as

$$K_V = A/\alpha$$

where

$$\alpha = \text{the lag angle}$$

and

$$A = \text{the shaft's angular velocity}$$

For example, if K_V is 200 sec^{-1} and A is $200^\circ/\text{sec}$ (33.3 rpm), the lag angle is 1° . In other words, the converter's output is accurate to no more than 1° , or eight bits.

Fortunately, commercial tracking converters have K_V 's that are equal to $200,000 \text{ sec}^{-1}$ and are feasible now with K_V 's that are three or four times higher. Thus, for the case where the shaft's velocity is $200^\circ/\text{sec}$, a converter with a K_V of $200,000 \text{ sec}^{-1}$ will have an accuracy of 18 bits, or 0.001° . For a speed of $20,000^\circ/\text{sec}$, or 3,333 rpm, the accuracy is 11 bits, or 0.1° .

The key point here is that the tracking converter's accuracy, for a given angular velocity, depends solely on the precision of the dividers and the response characteristics of the tracking network. Accuracy is strictly a question of design.

This isn't the case with a peak-sampling converter, whose accuracy is limited by the frequency of the primary voltage. Consider again the cases where the shaft's velocity is $200^\circ/\text{sec}$ and $20,000^\circ/\text{sec}$. The frequency of the signal that excites the resolver's primary is almost always 400 hertz; therefore, the converter samples every 1.25 milliseconds. A shaft spinning at $200^\circ/\text{sec}$ turns through 0.25° between samples. There-

fore, the converter is accurate to within only 10 bits, compared with 18 bits for the tracking converter.

If A is $20,000^\circ/\text{sec}$, the sampling converter is accurate to within only four bits, or 25° , compared with 11 bits for the tracking converter.

Obviously, peak-sampling converters can't be used in a high-angular-velocity system. On the other hand, they do outshine tracking converters when it comes to responding to step changes in θ , since they don't have to take time rectifying and filtering. In the worst case, a 180° step change, a tracking converter takes about 30 msec to update. In contrast, a sampling converter updates within 100 microseconds of the time the last sample was taken, regardless of the magnitude of the step. At worst, a sampling converter (again assuming 400 hz is the primary frequency) takes 1.251 msec to update.

But sampling converters have nowhere near the immunity to distortion possessed by tracking converters. In generating a d-c signal for its clock generator, a tracking converter's phase-sensitive detector measures only that portion of its input that's in phase with a reference signal. As a result, harmonics, noise, and out-of-phase components are ignored.

The situation is much worse with sampling converters because their accuracy depends on their ability to sample only the primary signal peaks. Harmonics, noise, and

quadrature components can mask the peaks. Most makers ignore the problems by assuming that the synchro or resolver data that their converters will have to handle will be clean. But in the factory, the airplane, or most other spots outside the engineering laboratory, a converter is likely to be exposed to spurious signals and harmonics from such sources as power supplies and the resolver itself.

To see how serious the problem can be, consider the case where the harmonic content of the resolver data is just 0.3%. In a peak-sampling converter, the samples would then be

$$V_1 = V_p \sin [\theta (1 \pm 0.003)]$$

and

$$V_2 = V_p \cos [\theta (1 \pm 0.003)]$$

Therefore, the maximum variation of V_1/V_2 would be approximately $\tan \theta (1 \pm 0.006)$. If, for example, θ is 45° , it can be measured to an accuracy of no better than 0.17° , or 11 bits.

This doesn't sound too bad; but remember, in this example the harmonic content is but 0.3%. MIL-S-20708C, followed in most military systems, permits the harmonic level of synchro and resolver data to be as high as 5%. It's with this type of distortion that a converter must be expected to deal.

Sampling converters can remove harmonics from V_1 and V_2 before they reach the sample-and-hold circuits

with matched input filters. Using filters, however, solves one problem by introducing another. A typical filter shifts its output by 80° to 90° . This shift is neither tightly controlled by the filter maker nor particularly stable with time and temperature. Therefore, though filters may take out harmonics and noise, they shift V_1 and V_2 in phase by unequal amounts. This raises the problem of ensuring that samples are taken at the proper time with respect to one another. The key to a sampling converter's accuracy is taking samples only when the 400-hz carrier peaks. If V_1 and V_2 are shifted, there's no way to guarantee that the primary and the two data signals all will be peaking at the same instant.

Even though sampling converters digitize within 100 μ sec, they are not suitable for random-access jobs because they are limited to an 800 samples-per-sec rate. Since digital systems are usually not synchronous with the 400-hz reference frequency, the access time of a 400-hz sampling converter must be viewed as no less than 1.25 msec.

Since they follow their analog inputs in a continuous series of least-significant-bit changes, tracking converters have access times on the order of 5 nanoseconds.

The simplest, and least expensive, multichannel system involving converters contains a single sampling converter connected to a number of independent synchro or resolver sources. A timing circuit steps the converter's input terminals from one source to the next. However, to ensure that the converter takes a sample from each source, the converter must be connected to each one for 1.25 msec. This has the effect of reducing the number of samples taken per source. For example, in a single-channel system, the converter samples the one source 800 times a second. If there are two sources, each is sampled only 400 times a second. As the number of samples per second drops, the accuracy of converter's readings drops with it.

Consider again the case where a converter is digitizing the angle of a shaft rotating at $200^\circ/\text{sec}$. In a single-channel system, the converter's accuracy is to within 0.25° (10-bit accuracy). Suppose now that we're dealing with a six-channel system, each channel carrying data from a $200^\circ/\text{sec}$ shaft. Now, instead of 1.25 msec passing between samples for a given channel, 7.5 msec pass. The accuracy then is 1.5° (seven-bit accuracy).

Still this is better than a tracking converter can do. Because of its poor step-input response, a tracking converter would need 30 msec to interrogate each channel.

The 100- μ sec digitizing time of a sampling converter can be exploited if all the data sources in a multichannel system are sampled simultaneously and the samples are multiplexed. This can be done by putting a sample-and-hold circuit in each channel, and stepping the input terminals of the converter's dividers from channel to channel. Each then has the accuracy of a single-channel system, up to a point. And that point is 12 channels, since there are only 12 separate 100- μ sec conversion periods in the 1.25 msec between peaks. Putting more into a system has the effect of decreasing the number of samples per second taken in each channel.

But in multichannel systems where better than 11-bit accuracy is needed, the only answer is to put one tracking converter into each channel and then multiplex the converter's output. ●

National comes full circuit

with sense amps.

The LM354A/SN7524 completes the logic and interface package for designers of mini-computers. Proprietary MSI circuits and a full line of the most popular second source DTL and series 54/74 TTL; everything into and out of the memory. Logically from National.

The LM354A and LM354. Pin-for-pin replacements for the SN7524 and SN7525 monolithic dual sense amps. Independent channel strobing built to fit the specs of the most demanding mini-computer designer.

Our LM354A features plus or minus 4mV maximum threshold voltage tolerance. Parts to even tighter tolerances are available on special order. All circuits are 16-pin dual-in-line silicone.

LM354A/SN7524—\$6.25 @ 100 up.

LM354/SN7525—\$4.80 @ 100 up.

We've taken a strong position in supplying production quantities of advanced ICs for the mini-computer manufacturer. Everything you need. Take it from National. Delivery, performance and competitive pricing always. Write for specs. National Semiconductor, 2900 Semiconductor Drive, Santa Clara, California 95051. (408) 732-5000. Telex: 346-353. Cables: NATSEMICON

TTL, DTL & linear ICs for the mini-computer.

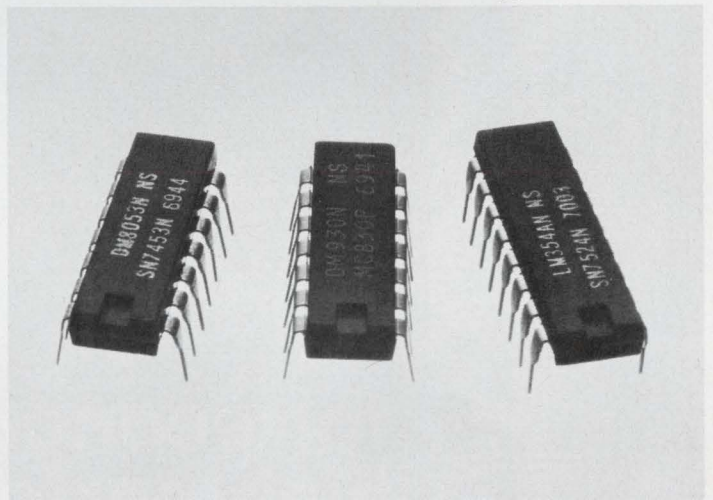

National/Linear



New flame resistant **GLASKYD[®]** **7100 FR**

Alkyd Molding Compound

for economical high performance connectors

This card-edge printed circuit connector won't singe your reputation.

Made with GLASKYD 7100 FR, it's replacing DAP for some mighty good reasons. Point 1—it provides comparable wet electrical properties at a much lower material cost. Point 2—it's economical in other ways, too. In slug form, its fast molding cycle increases production significantly. Point 3—it has low weight loss at elevated temperatures and permanent flame resistance exceeding normally accepted requirements. So specify New

GLASKYD 7100 FR alkyd molding compound over DAP for savings and quality right down the line.

Among the many types of GLASKYD available, chances are there's a GLASKYD molding compound that will meet your needs . . . for flexural strength, impact strength, arc resistance, low water absorption, flame resistance, heat resistance, dimensional stability, and many more advantages. Write today for technical brochure to American Cyanamid Company, Plastics Division, Wallingford, Connecticut 06492.

CYANAMID

SALES OFFICES IN: CHARLOTTE • CHICAGO • CLEVELAND • DALLAS • DETROIT • LOS ANGELES • MINNEAPOLIS
OAKLAND • PHILADELPHIA • TUKWILA, WASHINGTON • WOODBRIDGE, CONNECTICUT • ALSO AVAILABLE IN CANADA.

The broken promise of LSI: packaging

LSI makers risk lost business due to slow deliveries; users find costly chips are useless in flawed packages and package makers may be letting a market slip away

By James Brinton

Electronics staff

● The package for the large-scale integrated circuit rapidly is becoming more of a problem than the chips themselves. And it couldn't come at a worse time, as sales of LSI, especially MOS, began to bloom late last year and are booming in 1970. One company alone, Viatron Computer Systems, already has placed orders for more than \$50 million worth of LSI so far this year.

But the problems of packaging LSI devices seem to be growing faster than the market, and unless they are solved, they could slow LSI market growth. Reliability, assembly yield, and delivery problems plague users of large ceramic packages. Major suppliers like TI complain that package suppliers are slipping in their schedules and are unwilling to put capital into development of new package techniques. Package suppliers also don't want to tool up for lines of different LSI packages now because they fear obsolescence, and worry that the really large markets for LSI arrays are still on the horizon.

Because of these problems, several LSI suppliers are developing in-house package design and manufacturing facilities, and may even

begin competing with traditional package makers in what could easily become a restructured LSI package market.

A spokesman for a major user of the flatpack and dual-in-line LSI packages sums up his problems this way: "Array complexity and many pinouts mean high assembly costs and low assembly yield. The packages themselves are costly; yet they crack, break, and warp; their seals open, pins fall off . . . and on top of it all, we can't get delivery."

The problems are hurting the MOS houses in particular—and at a time when demand is high. "It's a seller's market in packages now," says Michael Goulla, senior buyer at General Instrument's Semiconductor group. "We're not only having trouble getting packages, we end up throwing out two for every three delivered," he adds. And according to a packaging industry authority, wire bonding and assembly waste about 2.5 packages for each LSI device delivered.

"We've never had real problems getting chips, but we've had to beat the bushes for packages," says Edward M. Bennett, president of Viatron Computer Systems Corp.

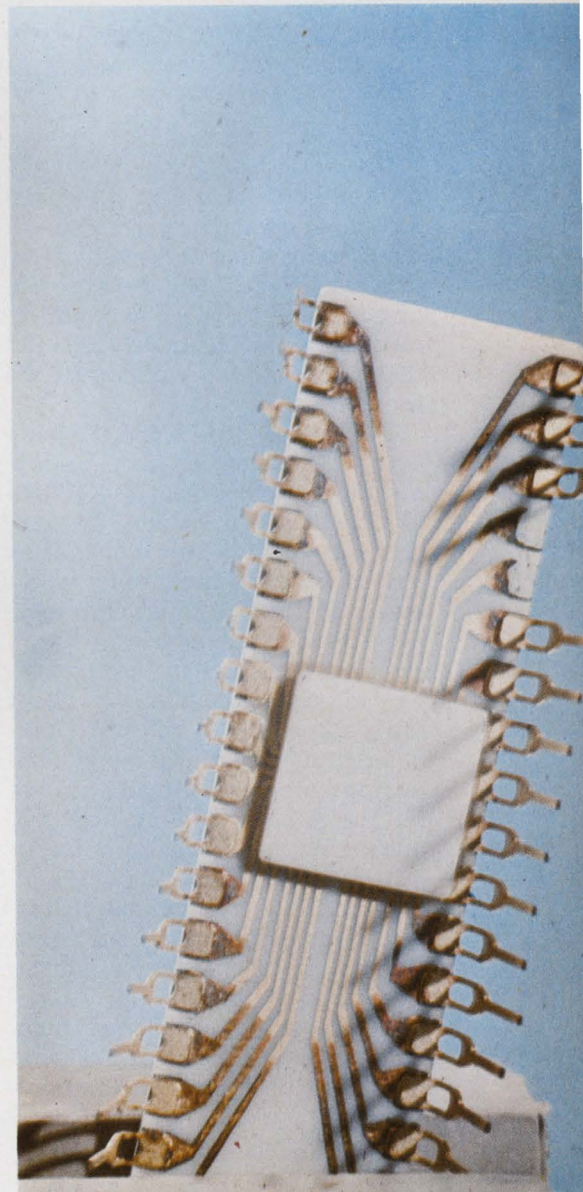

The purple. Conductor discoloration may be harmless flux corrosion. But missing leads are irreparable, and make users of today's often costly LSI circuitry angry.

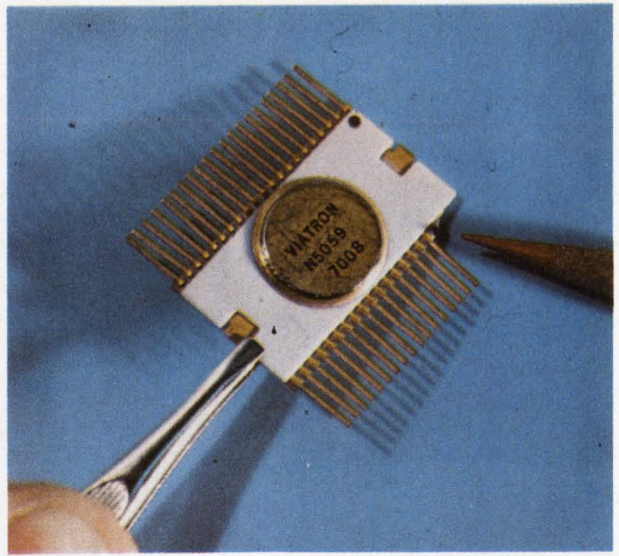
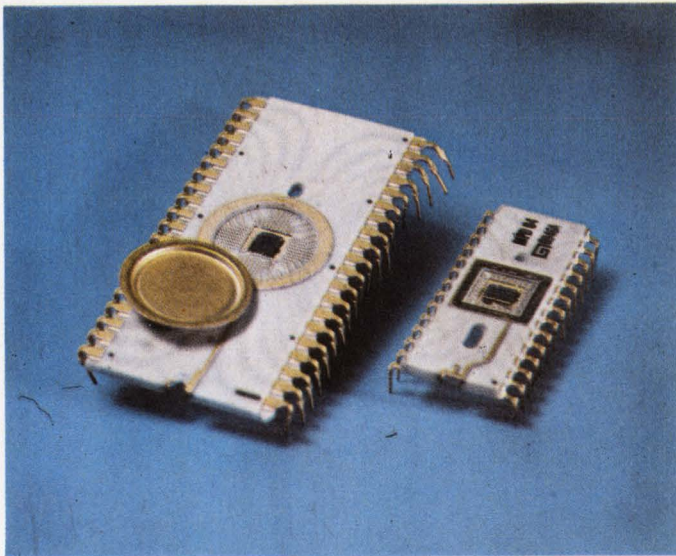

Damaged in transit. The photo on the left shows packages from different vendors which lost their caps, and their hermeticity, in transit. At right is a package with one corner missing. Leads and ceramic are gone, as if the package had been clamped in a vise and broken.

Viatron's vice president for micro-electronic operations, Lawrence C. Drew, adds that only half of the firm's packaged LSI devices survive printed-circuit board attachment, and this effectively doubles the price of every package the firm buys.

Delivery is a problem at nearly every LSI maker or user. "Delivery times are way out," says Robert Kessler, LSI systems manager at Texas Instruments, which often has to wait six months for packages. He feels material and package suppliers are overloaded with business, and perhaps are overextended and overoptimistic about the pace of their deliveries. Another firm placed a seven-million-package order last August, and so far has received only about 10,000 units—many of them defective or missing critical parts.

Reliability is a factor, too. George L. Schnable, manager of advanced materials and technology at Philco-Ford, implies that while LSI devices are more reliable per function, smaller IC's may be more reliable per package—thus narrowing LSI's edge. Bulkier packages, more wire bonds and pins, large area seals, and other factors seem to work against the LSI package.

Mice? Despite foam plastic packing, some packages arrive with corners missing, as if mice had nibbled at them in transit. Packaged devices arrive for incoming

inspection with loose or missing caps—and with damaged wire bonds or chips. Some packages look good from a distance, then users find pins attached out of registration with the contact pads on the ceramic. These packages are hard to install; frequently, pins are lost, and occasionally pins even short adjoining contact pads.

General Instrument has had so much trouble with warped and cracked packages that it is developing a proprietary method of reclaiming them, according to Robert Koch, manufacturing engineer.

Disassembly. More packages fail in assembly as leads break off or bend, endangering the hermetic seal. Sturdier pins would seem to be the answer, but these already are available, says Viatron's Drew, and fail anyway. "Either the brazed connection to the package contact breaks, or the whole contact pad lifts off the ceramic, carrying the lead with it," he says, "and there's no way to repair a package when that happens."

Post-assembly failures occur too. One firm's packages develop a purple discoloration that moves from the brazed-on pins inward to the seal protecting the LSI chip. The maker insists that it's only cosmetic—a flux corrosion—but at the going price of LSI chips, few users want to risk a pin or seal failure.

Money. With chip makers throw-

ing two packages away for every three delivered, and using 2.5 packages for every delivered LSI device, price becomes an important issue. TI's Kessler cites the "significant cost packaging adds to over-all circuit cost," especially in his specialty area of semiconductor memories. GI's Goulla is brooding, too; he says GI pays about \$1.50 each for 40-lead dual-in-line packages in lots of 50,000 per month. Even if every package made it through incoming inspection, the packaging cost per chip would still rise to \$3.75 plus labor and other overhead if the 2.5-1 ratio is trustworthy.

Squeeze. Package makers like Mitronics Inc. note that the quick rise in demand from the MOS industry largely is behind today's shortages, and others think the same demand may be holding prices up. Allen Davis, Mitronics' California sales manager, says he could probably sell his industry's entire output to MOS makers alone.

Robert Applewhite, American Lava sales supervisor, says that even though his firm has concentrated on MOS demands to the exclusion of bipolar LSI packages, it still is pressed to meet demand. He estimates that his industry delivers 750,000 to one million packages monthly, and predicts two to three million a month will be required by the end of the year.

And even though all package

makers are expanding, he adds, industry only has a fair chance of catching up with demand. One worry is that even if "package suppliers boosted output, it would only encourage MOS makers to sell more," thus extending the catchup period.

The task is further complicated by the variety of package styles needed by LSI makers. Applewhite notes that in DIP form alone, LSI makers want 40-lead packages with leads on 150- or 600-mil centers, and there are hints of 50- and 60-lead package requests to come. Obviously, standardization would help, but LSI and package makers alike continue to back their own designs.

And for those that don't have their own designs, a compromise often is necessary. Joseph P. Murphy, semiconductor operations manager at Four-Phase Systems Inc., points out that the company's upcoming computer had to be partitioned around available package styles—28- and 40-pin dual-in-line—even though other pin numbers and arrangements would have made the design more efficient.

Squeeze. Spectacular growth in demand, together with a nickel shortage which made Kovar alloys scarce, plus a shortage of ceramic materials, caught up with the packaging industry late in November of 1969.

There are other factors, too. Tight money and the package makers' honest uncertainty about a quantity market for large, expen-

sive packages, led many to withhold capital investment in production equipment and materials.

An American Lava spokesman sees no rush to invest in new tooling for packages that might be quickly outdated. In addition, he says, materials procurement and turnaround times are long in the packaging business. So it would seem that unless it turns to its own resources, the LSI maker must gird for a long wait.

And now the situation has become known as the package squeeze. General Instrument's Goulla sees little relief until at least 1971. By then, he feels, package makers will have expanded their facilities, which also should bring down costs. Goulla anticipates prices dropping to 50 to 80 cents within 18 months. But these are prices LSI makers already say they need.

R.S. Carlson, general manager of Autonetics' Products division, foresees package woes in Anaheim for up to six months, and is trying to qualify added suppliers for the company's special 42-lead, co-fired DIP.

Now the gap between the ability to produce and the demand is so great that Carlson says his operation is living a "hand-to-mouth existence."

He isn't alone. One LSI maker has a flying courier squad which moves from plant to plant by jet, picking up packages almost as soon as they are made. Another firm uses its two executive aircraft

largely for carrying LSI devices and packages. Viatron runs a nearly continual shuttle service among its MOS LSI vendors, borrowing packages from "haves" to lend to the "have-nots."

Lemon Oil. There's more bitterness and less mutual understanding about price. While spokesmen generally agree that, given enough time, the physical problems of packaging could be solved, the mention of price is a red flag. Generally, LSI makers and package makers accuse each other of gouging.

According to one package maker, a large West Coast MOS manufacturer requested bids of just over 90 cents on a custom DIP in lots of a million. The package firm didn't feel it could respond at less than \$1.25, a price the MOS firm felt would cut into its profit. In fairness to the package maker, the contract would have tied up its production line while neglecting an already profitable 40-lead dual-in-line product.

And this isn't an isolated case. At Autonetics, David Nixen, manager of packaging and assembly development, feels that a further reason for the shortage and cost of LSI packages is the maker's desire to stick with what Nixen judges to be their money makers, 14- and 16-lead DIP's.

Each of these complaints could be answered in time, but for firms with heavy LSI commitments—like Autonetics, Viatron, GI, and others—the time's not there. Autonetics is heavily involved in MOS production for the Sharp Corp.'s electronic calculator and is having much less trouble with MOS yield than package delivery. Sharp is reported to have turned to a Japanese package source and to be tooling up for its own MOS.

Viatron, eager to get as much of its controversial System 21 equipment into users' hands as possible, has tried vendor after vendor in search of packages for its own MOS, and isn't thrilled—or sufficiently supplied—by any of them. And Viatron's outside MOS sources also are cramped by the squeeze.

For the different approaches that LSI package users employ in designing and building their own packages, see the story beginning on page 126.

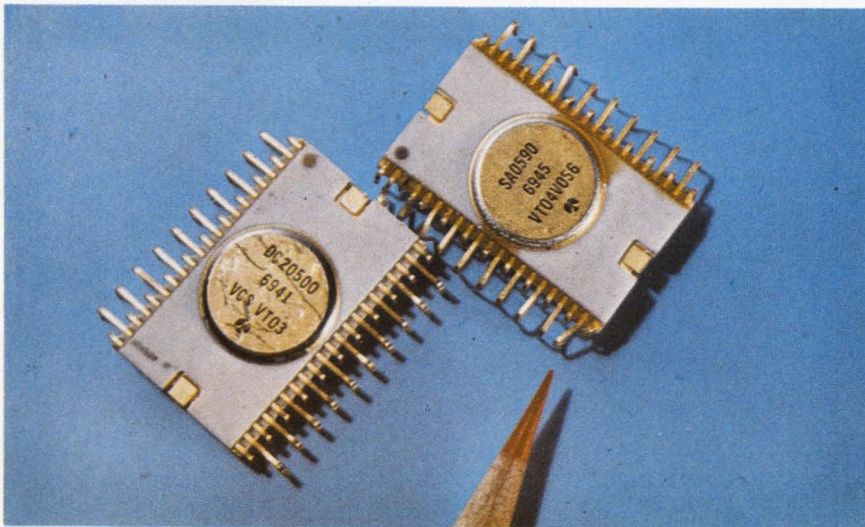

Quick fix. To reinforce this LSI device, Viatron engineers laid a bead of plastic down along its edge, but still the pins bent and broke off.

LSI makers pick up the pieces

● No LSI manufacturer wants to wait out a packaging squeeze that could take months before it even begins to ease up. And with a fast-growing chip market forecast for 1970, semiconductor firms are asking their own staffs to design their own packages—sometimes applying very advanced techniques. If these companies decide to build, as well as design, their own packages—and many of the important semiconductor houses are heading in that direction—the profile and technological makeup of the packaging market could change significantly.

Many firms already have prototypes of in-house-designed packages. Most are aiming for reliability and deliverability, but at the same time, semiconductor firms are pushing for higher levels of integration through multichip techniques, seeking to cut interconnections and pinouts to a minimum, and trying to reduce labor costs.

Thus, typical of other firms caught in the squeeze, Viatron has designed its own package, and now has it in prototype form. GI, Motorola, Fairchild, TI, Hughes, Raytheon, and others are doing the same, or seriously thinking about it.

Generally, each firm feels that it may be able to ease the squeeze by going directly to materials suppliers. Most also hope for drastic cuts in package price. Others look forward to optimized partitioning and assembly yield through packages tailored to their needs. And if these in-house production facilities turn out to be greater than what is needed for “bail-out,” it would seem that some of these firms will indeed reduce the share of the market which opened for package makers in 1969.

Do-it-yourselfers. The MIT-Lincoln Laboratory’s beam-lead substrate work appears to be having a significant effect on these efforts. Robert E. McMahon, leader of the laboratory’s microelectronics group, is known as the pioneer in the field.

The beam-lead substrate ap-

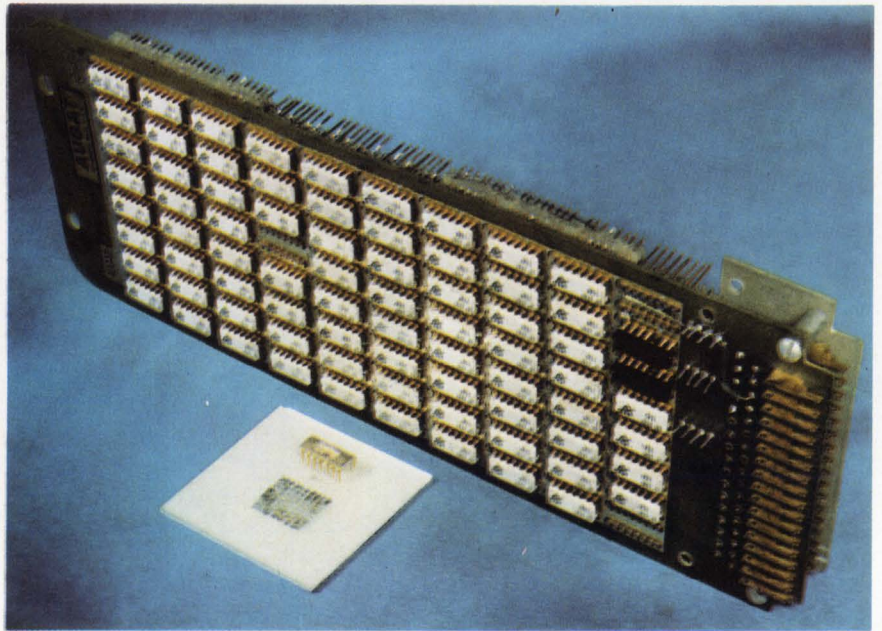

The package as the enemy. A million to one is the ratio of total volume to chip volume in this multiplexer made up of 80 dual-in-line TTL packages. Lincoln Lab’s Robert McMahon computes that interconnections and support structure account for 98.5% of total volume, with DIP’s representing the other 1.5%. Density is only one chip per cubic inch.

Beam leads on Kapton.

More chips per cubic inch—by several orders of magnitude—are in this 36-chip, 24-by-24-bit memory plane developed at Hughes by K.C. Hu. Paralleling McMahon’s work, Hu is using beam leads on Kapton over ceramic to create multichip assemblies with greater partitioning freedom, fewer interconnection bonds, and perhaps a lower price tag than now is possible with single-chip LSI packaging techniques. Hu now is working on a kilobit memory plane using the same Kapton-on-ceramic technology.

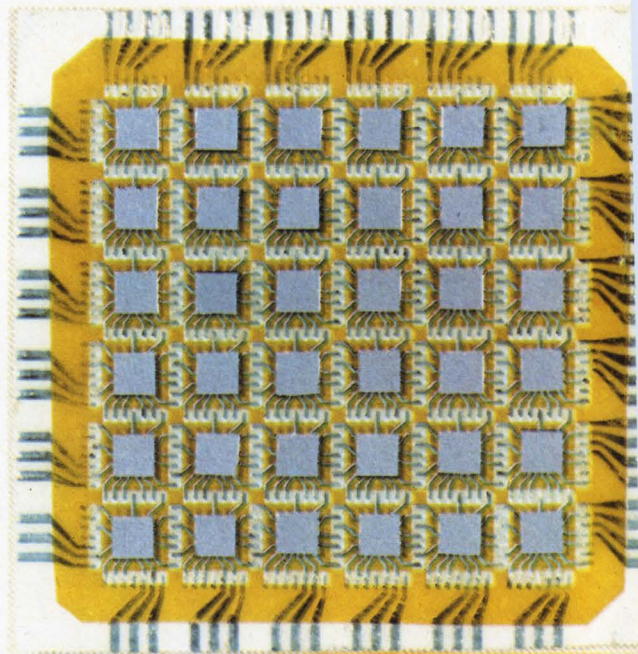

proach was born out of an abortive attempt to miniaturize a subassembly built out of dual-in-line-packaged IC’s, says McMahon. The assembly took up about six cubic inches, used 18 large DIP’s, and

thus held about three standard-sized IC’s per cubic inch. McMahon’s group tried to whittle down the size through giant flatpacks capable of holding 20 or more IC’s—but the assembly still was only a

cubic inch smaller after the redesign; higher density within the package hadn't helped much.

"Interconnections, printed-circuit boards, supporting frames and connectors were about 98% of the volume in both cases. Obviously, the thing to do was to reduce interconnections and supporting structure," he says.

McMahon's group took another whack at the problem, breaking it down on a basis of fewest interconnections at the p-c board level, but this required an arbitrary package size. "So we tried to do away with the package," he says. "And we found we could cut volume by 40-to-one over dual-in-lines."

After this initial success, McMahon's group found that Kapton, a polyimide plastic, could serve as a substrate yielding tighter packing densities at lower cost than alumina. And it soon became obvious that different kinds of logic could be mixed in the same beam-lead substrate. Also, chips of any design could be selected for the best combination of integration and yield for lowest cost. The technique even lent itself to automation; chips could be aligned on vibrating tables, soldered to a thin copper heat sink sheet, the Kapton laid over them, and the overhanging beam leads quickly bonded.

Requests began to pour in three to six months ago as manufacturers either anticipated or were hit by the package squeeze. Indeed, the beam-lead substrate idea already has taken root at General Instrument, Motorola, Viatron, and Hughes.

Variations. Working at Hughes Aircraft, K.C. Hu is using Kapton and beam-lead substrate concepts to construct multichip memory systems, like the one shown on page 126. Instead of placing all interconnections atop the plastic and using crossovers or crossunders like McMahon, Hu uses an x-y grid of conductors separated by a dielectric layer. On it, Hu places so-called carriers which are themselves miniature beam lead substrates, made on plastic with flip-chips bonded on them face down. The carriers have metalized leads extending beyond their edges, and these in turn are bonded through openings in the dielectric to the

The Lincoln Lab legacy

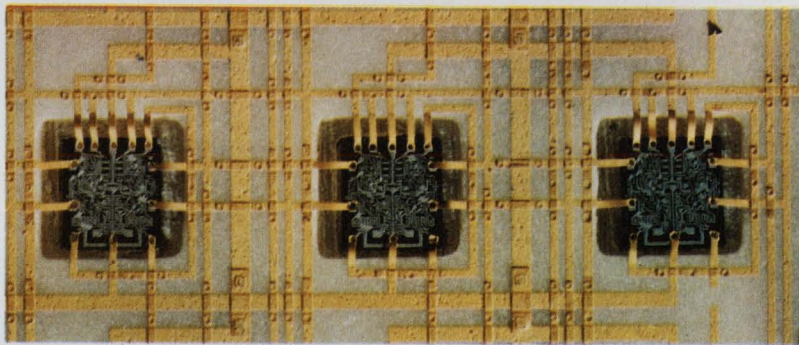
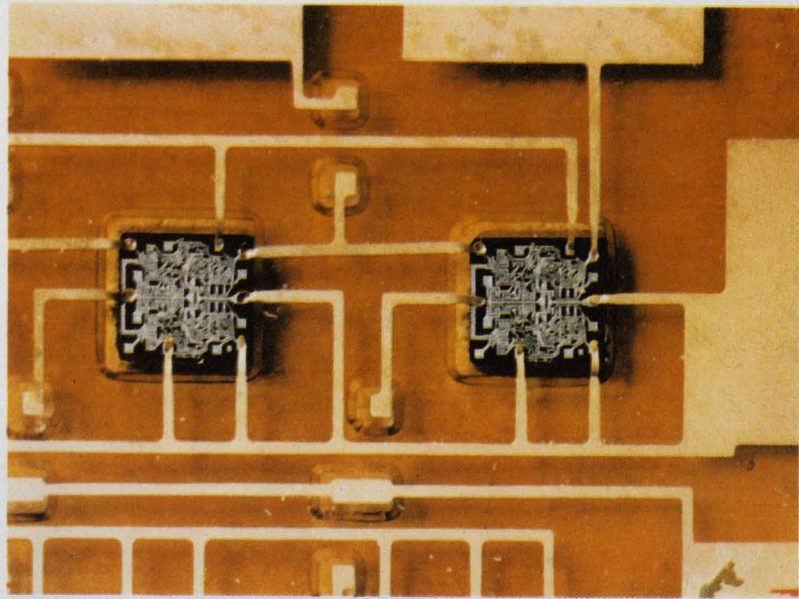

Robert E. McMahon's MIT Lincoln Laboratory microelectronics group has worked on beam-lead substrates since 1967-1968 [*Electronics*, Aug. 19, 1968, p. 52]. Working with a variety of substrate materials, including glass and silicon, they finally settled on alumina and a polyimide plastic, Kapton, as most practical.

The top photo above, and the one on the cover, show beam-lead substrates made with Kapton. The cover photo details two crossunders for use with intersecting interconnections; crossunders also are made possible by adding another layer of Kapton. Only crossunders are used with alumina substrates. Connection between conductors is via a hot-tip bond.

Chips are laid down in registration with the windows on the substrate and are soldered to a copper-clad heat sink. Unlike some other approaches, Lincoln Lab doesn't isolate the chip in plastic. The group's alternative approach is a bonder which raises each chip to the level of the substrate, and then makes the necessary bonds. Then the whole assembly is attached to the copper-clad heat sink sheet.

Interconnection patterns are created by familiar photoresist techniques, but the neat windows in the Kapton are etched with a caustic solution.

According to McMahon, the price of the Kapton beam-lead substrate is less than 50 cents per square inch. Thirty to 40 standard-sized chips can fit on a one-square-inch area in the current state of the art.

Ceramic substrates are both more costly and difficult to make. In one method, the windows are punched out of "green" ceramic, which then is fired. Afterward, the windows are filled with glass and the interconnection pattern is laid down over them, then the glass is etched away. A second approach uses a thin layer of a photosensitive material called Riston; it's laid on the substrate over the open windows; plating and deposition of conductors is done over this, and the extra Riston is removed later.

Raytheon—the ceramic approach

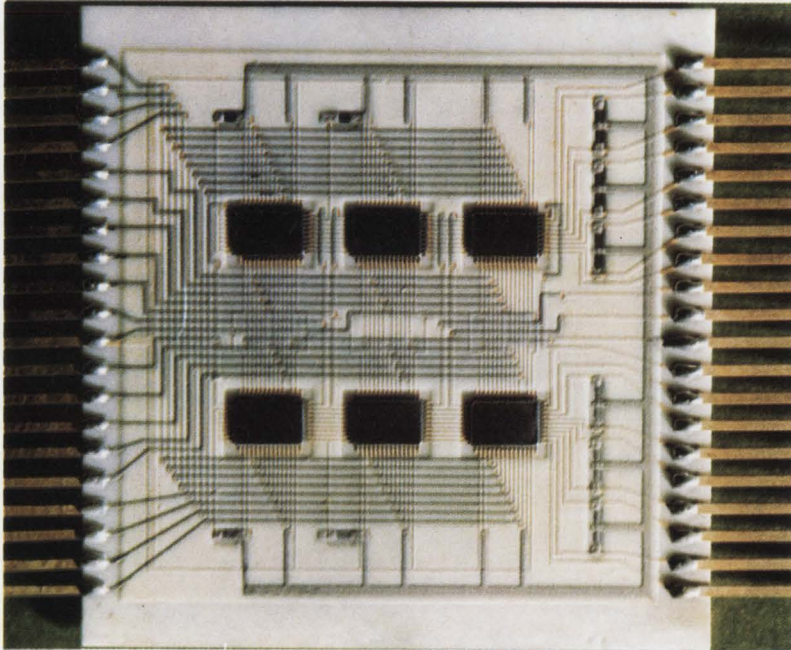

Ray-Pak began in the mid-1960's with polyurethane-protected ceramic circuits packaged four to a card in a plug-in format measuring about four inches by five inches. Though crude by today's standards, this hybrid scheme cut the volume needed to package the sub-assembly by four to one over discrete wiring.

From this kind of package to the sort shown in the photo above there were several evolutionary steps, each shepherded by Stanley M. Stuhlberg, hybrid circuits department manager at Raytheon's Missile Systems division. But now, Ray-Pak is achieving high packing densities in a sturdy format using Raytheon's own beam-lead large-scale IC's, multilayer metalization, and a variety of pinout configurations.

The Ray-Pak line is assembled in separate sections—substrate, seal, collar, another seal, and cap. But the idea of a homogeneous ceramic package made possibly with fewer firings led to a proposal to the Army for work on a contract for an advanced LSI package, shown in the smaller photo above right.

Raytheon built two variations of this package. The one shown in the photo allows users to drop in a hybrid or monolithic device up to an inch square; the other is a substrate/package combination. According to Stuhlberg, "the idea would be for the user to buy it,

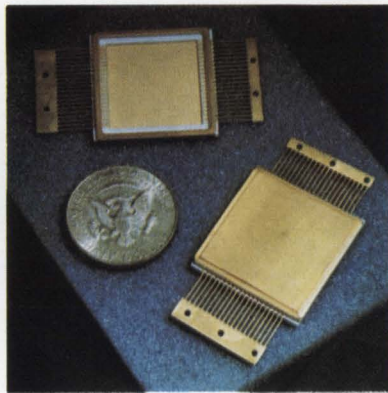

put his own metalization and componentry on it, then cap it."

Both packages would adapt the co-firing technique pioneered by Autonetics. They would be formed of squares and rectangles of unfired ceramic with pinout and ground-plane metalization (if needed) deposited before assembly. Then the stacked parts would be fired at about 1,500°C, creating a homogeneous package with a hermetic seal around the pinout conductors.

The four-inch-long seal around the Kovar cap has been made with a yag laser welder, which Stuhlberg says does a fine job at low cost, and also with an electron beam welder, which Stuhlberg prefers, but says is more costly. In any case, no solder is needed to make or to seal the packages, making them suitable for high nuclear-radiation environments, to the delight of both the Army and Stuhlberg.

x-y conductor grid to set up the desired memory organization. Hu foresees possible automation of the process by making the carriers in strips and laying them down quickly and consecutively.

Material and equipment cost is very low, he says; chip bonding is done in one operation using flip-chips; carrier bonding also could be a one-shot process, and the Kapton assemblies easily withstand -55° to $+125^{\circ}$ C temperature ranges.

Say goodbye, Bond. Motorola's Roger Helmick, manager of digital IC planning, regards bad wire bonds as the biggest reliability culprit in LSI. And so, he says, Motorola is using a new "beam-lead laminate" concept to eliminate them.

Apparently, the method converts standard chips into beam-lead devices by using a small metalized plastic sheet to hold pinout connections. Bonding at the chip could be either pad by pad or perhaps by wobble bonding; bonding these "poor-man's beam leads" to the substrate also could use wobble bonding. So far the system has been used in an 8,000-word memory module which mixes MOS storage arrays with bipolar driver chips.

GI Issue. General Instrument may be interested in something similar to the beam-lead laminate, according to Robert Koch, manufacturing engineer. Koch's idea would use a Mylar sheet with pinout metalization to connect chip and substrate in only two quick, cheap wobble-bonding operations. He feels that something like this is needed to get manufacturing yields up to the point where envisioned 60- and 70-pin packages will be practical. He figures that to succeed in making every wire bond good on half of the packages assembled, the average factory assembler would have to be 99.999% accurate. Even at the 99% level, packaging yield falls below 50% for 60-lead devices, each of which requires 120 wire bonds.

Perhaps furthest advanced in variations on the beam-lead substrate is Viatron. Jay R. O'Donald, manager of array engineering, is reviewing prototypes of a package that uses plastic-backed beam

The best gets better.

The HP 5248 General-Purpose Counter can now measure to 3 GHz with a single plug-in—without any gaps. This is made possible by our new 150 MHz to 3 GHz Heterodyne Converter, Model 5254C, and by extending the direct counting range of the 5248 counter mainframe to 150 MHz.

There's another benefit unique to these instruments that's not immediately apparent. Converter and counter ranges actually overlap so you derive the final answer by merely adding the converter dial reading and counter reading. There's no need to remember to subtract readings over any part of the frequency range.

Even before the latest improvements, no other counter could match the

usefulness and flexibility of the 5245 Series. We now offer fourteen different plug-ins to help you make all the measurements you need. These include six frequency converters; transfer oscillator to 18 GHz; two time interval units; two prescalers; video amplifier; DVM; and preset unit.

And you can't beat the 5245 line for reliability either. Its remarkable dependability has made it extremely popular, particularly with rental firms—some of our best customers. When their clients rent an HP counter, rental firms know they won't lose rental fees because of downtime.

The price of the new 5254C Heterodyne Converter is \$825. The

5248L counter is \$2900. You won't find a more economical single-package solution to your dc to 3 GHz counter needs. Your local HP field office has all the details. Give them a call. Or write to Hewlett-Packard, Palo Alto, California 94304; Europe: 1217 Meyrin-Geneva, Switzerland.



HEWLETT *hp* PACKARD
ELECTRONIC COUNTERS

02918

Circle 129 on reader service card

**There's a
new reason why
this continues to be
the world's most popular
counter line.**



Viatron's home brew

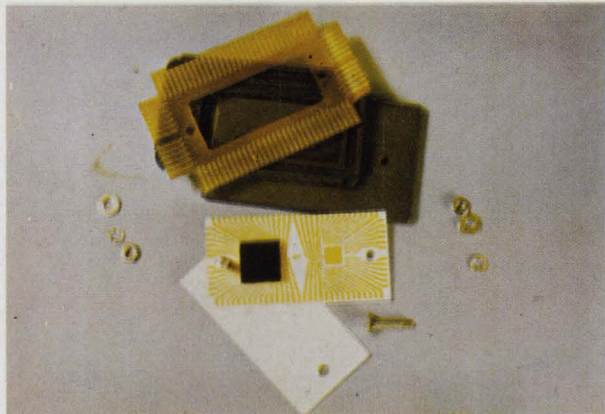

First. Here are the separate parts of the Viatron package: the white plastic insulator is on the bottom, and the ceramic substrate is atop it. Above is a stack of other parts, with the brown Kapton lead frame on top. A compressible rectangular spacer is beneath it, and the gray metal cap is on the bottom of the pile. The black cubic object at the left of the substrate conceals an LSI device and adds a measure of mechanical protection. Hermeticity is provided by a conformal coating of parylene plastic.

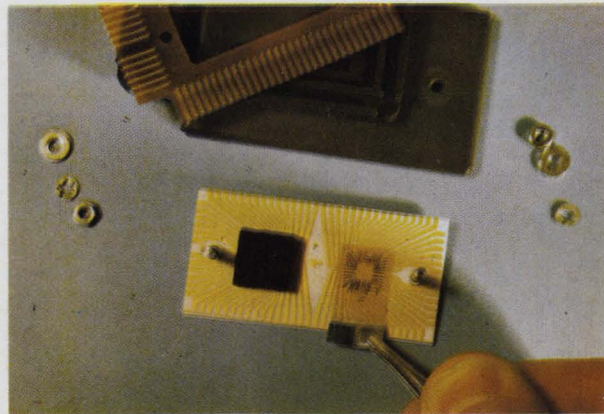

Second. Although no LSI chip is visible, Viatron's method of connecting chip to substrate is as follows: held in the tweezers is a tiny Mylar lead frame on which a pinout pattern is metalized with the chip attached to the substrate, perhaps with conductive epoxy. Viatron would use the Mylar lead frame to connect chip pads to substrate metal in two wobble-bonding operations, one for the chip, one for the substrate. Labor cost would be far below that for wire bonds.

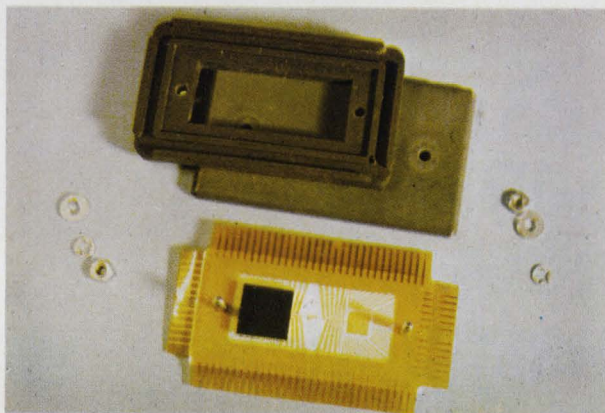

Third. What the Mylar lead frame does for the chip, the Kapton lead frame does for the ceramic substrate. It should be nearly impossible to lose one of these pins except with a pair of scissors, because Kapton's initial tear strength is more than half a kilogram per mil, and is far stronger than techniques using discrete pins. Nor is it likely to expand out of registration if heated; its expansion coefficient is about two-millionths of an inch per degree C. Note the ridges on the bottom of the rubber-like spacer placed on the gray metal cap.

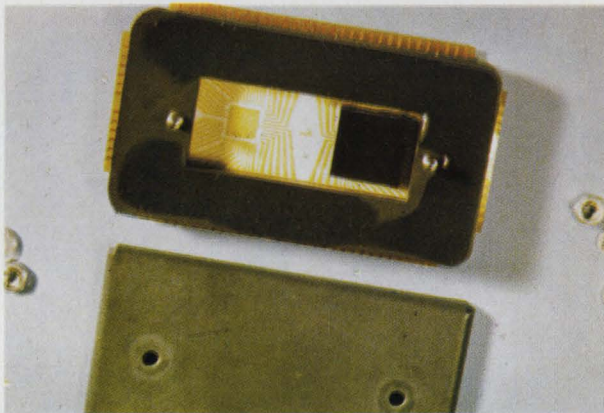

Fourth. Now the spacer is in place. The inner ridge, shown in the last photograph, forces the Kapton lead frame against the ceramic conductive metalization. This may be all the bonding that's required, and Viatron is experimenting now in hope that it is. If so, the firm would use the outer ridge to press the Kapton pinouts down on the printed-circuit board conductors, hopefully eliminating another bonding step. Throughout assembly, all parts are aligned with the two bolts that hold the package together.

leads both to pin out of the chip and out of the package.

A ceramic substrate holds one of the dice, and a tiny Mylar sunburst of beam leads is wobble bonded first to the chip, then to the substrate metalization. After coating both chip and substrate with parylene, the chip is capped with

epoxy, and a larger array of Kapton-backed beams are laid down on the ceramic's periphery and the device is covered with a flexible spacer to assure tight contact between the substrate and Kapton pinouts. The whole package, including a metal cap, is aligned and held together by careful position-

ing of two bolts. The Kapton package pinouts could be either bonded to the p-c board or held there by pressure (see panel above).

Viatron's Lawrence C. Drew, vice president for microelectronic operations, notes: "Our goal is to get rid of the package and the labor needed to insert and connect

chips. We've been forced by low assembly yields and by anticipated array complexity to strike out on our own." But not totally—Viatron men have had some earnest conversations with Lincoln Lab's McMahon.

Drew admits that such a non-hermetic package would give gray hairs to a Mil-spec-oriented engineer, "but our machines operate in a benign environment," he says. The average business computer isn't going to encounter the wide temperature and humidity extremes of military gear, "and besides, between silicon nitride, glass, or parylene passivation our chips should be safe from contamination, and with epoxy and metal caps, they'll be safe from physical harm."

Initially Viatron will produce the package in single-chip form, says O'Donald, moving to double-chip packages when the plastic beam-lead packages produce assembly yield's above 90%. And neither Drew nor O'Donald think this is out of reach.

A two-chip version would offer a total of 88 pinout locations. By buying the ceramic itself and making its own packages, Viatron hopes to produce the two-chip version for 15 cents, the one-chip version for less than a dime.

Fairchild is making its own packages now — 24- and 36-pin DIP's. Fairchild's Sol Shatz, says the company is "involved to the extent of assembling piece parts ourselves—we will not depend on others for complete packages." There's a lot of effort going into new semiconductor technology, he says, "but there's not enough being done in packaging; the last so-called new idea was the DIP." But at Fairchild, as at other firms, this is changing.

Shatz holds a patent that he feels may be a solution to package cost through automation. In the patent, a half-inch square of ceramic holds IC chips in two grooves; the chips can be inserted automatically and held by epoxy. An interconnection pattern then is laid down on the ceramic square and is inserted in a larger carrier, this one of arbitrary size with half-inch grooves. Then thick- or thin-film conductors interconnect the half-inch substrates, and bring pinouts to the edge of the carrier.

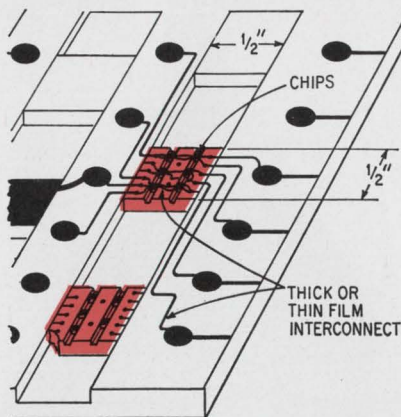

Groovy. By using a building-block approach to chip and substrate assembly, Fairchild may automate multichip LSI assembly and packaging.

Each successive insertion could be automated, and each metalization layer could be batch-processed. The final assembly would be potted or cased, and would cost less to produce than wire-bonded devices.

Conservation. Companies like Raytheon, the Bell System, and others may represent the conservative wing of package development. These firms, and others, like American Lava, are using ceramic flatpacks, but are pushing the state of the art to get as much efficiency as possible out of them.

Raytheon's Ray-Pak is a ceramic line which has grown up with time. Ray-Pak began several years ago with a hybrid IC effort at the company's Missile Systems division and has evolved into a sophisticated ceramic package which now holds many of the multichip devices going into its military systems (see panel on p. 128).

Based on this work, the Army Electronics Command selected Raytheon to develop an advanced ceramic flatpack larger than a 50-cent piece to house LSI and hybrid devices. It is said that the Army wants to standardize its systems around such a package in the future.

American Lava, with a vested interest in a continuing market for ceramic packages, has developed a ceramic package with many of the characteristics of a multilayer p-c board.

The package, according to American Lava's William Hargis, adapts itself to differing chip formats: flip-

chip, beam lead, etc. The package itself supplies multiple levels of interwiring for these chips to minimize pinouts. Hargis points out that this also allows higher packing density and thus less propagation time between IC's.

The user would supply American Lava with the chip layout pattern, and the artwork for the multiple levels of interconnection. American then would build up the package a layer at a time using "green," relatively soft, ceramic; interconnection between layers would be through so-called "vias," conductors in holes linking adjoining layers.

American Lava would stack the sandwich, fire it, and thus create a homogeneous assembly. To seal the package, a metal ring would be attached on top and a metal lid brazed or welded to it. So far the process isn't ready for high-volume production, but Hargis says that problems of camber and "via" alignment have been solved.

Outcome. The effect of this in-house packaging effort among LSI makers may be to reduce the current share of market occupied by the package makers. Some LSI makers will build at least some of their own packages; Texas Instruments and Fairchild already do, and Motorola may try building its own "beam-lead laminate." Viatron plans a full-scale package production operation. And among them, these four firms probably account for more LSI than any others.

But the growth in total demand for LSI may offset percentage losses in the package vendors' share of the market. Even so, they may be tooling up for slimmer pickings. During the past few years small new firms have entered the packaging field, and some LSI makers are looking forward to passing along their new ideas to these companies for production, or at least for second sourcing. GI's Goulla mentions two the industry watches with interest: Ceramic Metal Systems, and the SCS Corp. Viatron's Raymond T. Fitzsimmons, senior packaging engineer, says that USES Corp., looks promising.

Thus, the package market has been changed by the package squeeze, and while more LSI packages than ever will be needed, business isn't going to be spread around the way it once was. ●

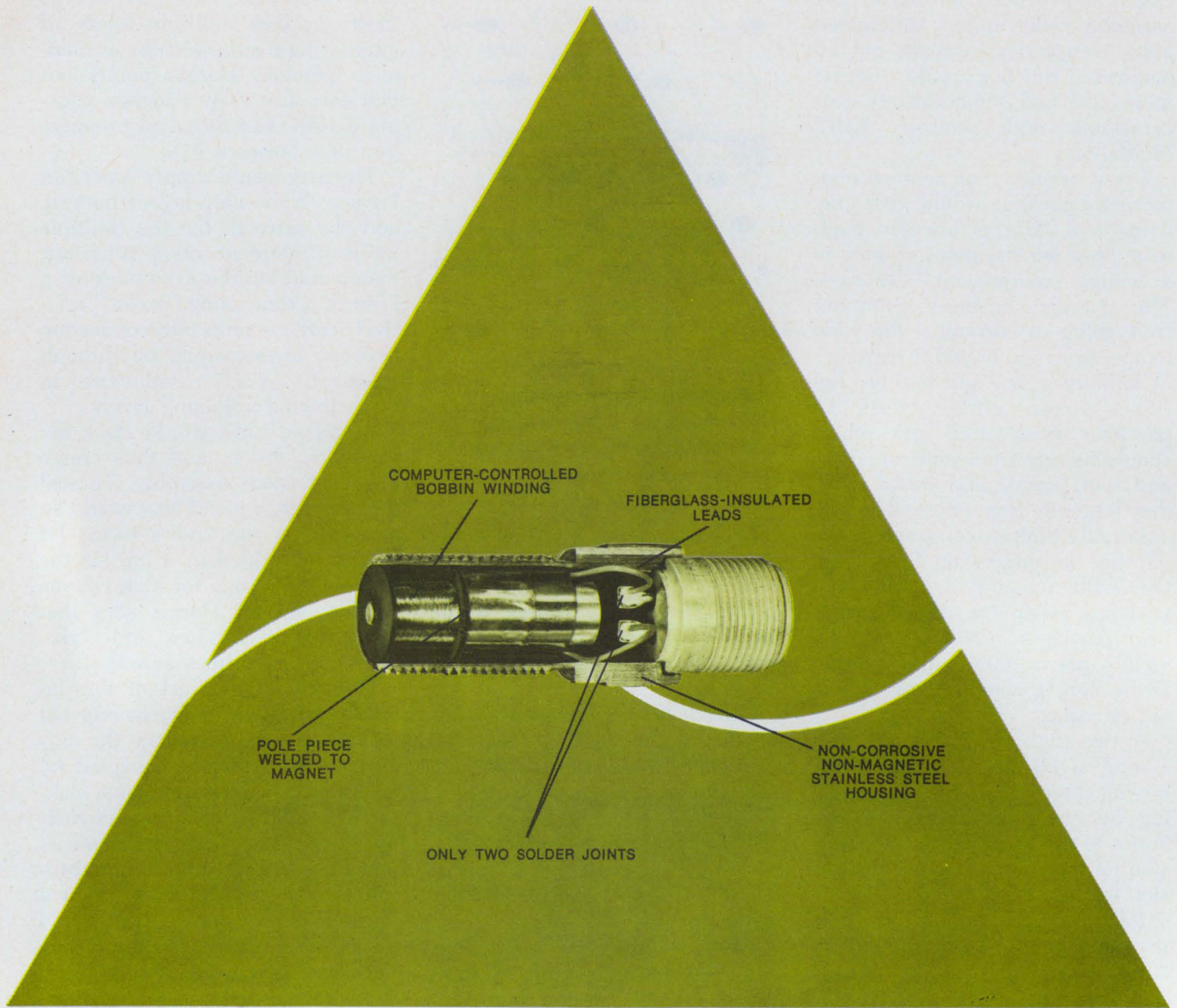

Airpax challenges the competition to show you these features in their magnetic pickups.

Airpax builds quality into every magnetic pickup. Improvements our engineers have made assure you of a reliable device for the most demanding application. **Another Airpax component of confidence!**

□ Compare these new Airpax features with other quality pickups. Non-magnetic, non-corrosive stainless steel housing for performance in severe environments. And a separate rugged bobbin with a computer-controlled, machine-wound coil. Elimination of the air gap by

welding pole piece to magnet assures constant output. **Only two solder joints** . . . for increased reliability. And internal fiberglass-insulated leads add heat resistance to +550°F. □ No wonder there were Airpax pickups on the manned lunar landings! For more information on the complete magnetic pickup line, write or call **Airpax Electronics, Seminole Division**, P. O. Box 8488, Ft. Lauderdale, Florida 33310. Phone (305) 587-1100. TWX: (510) 955-9866. Telex: 051-4448.

AIRPAX . . . components of confidence.

MOS array is custom-programmable

Costs of tailor-made design are greatly reduced by technique for etching holes in oxide; initial jobs seen in process control

Custom-designed random-logic integrated circuits at the price of catalog IC's—that's what Texas Instruments is offering in its programmable logic arrays (PLA's). These arrays are metal oxide semiconductor devices in which the logic can be programmed simply by etching holes in the oxide in the appropriate spots. To connect an MOS transistor in the silicon substrate into the logic pattern, a pit is etched in the oxide over that transistor, deep enough to leave only about 1,200 angstroms of oxide over the device. Then, when metal is deposited in the pit, it acts as the gate electrode and also connects the transistor to the logic network.

This means that a single-mask—the oxide-removal mask—is sufficient to program the chip; the other masks are identical for all circuits. Thus, costs of customizing are greatly reduced and so is lead time—to 90 days.

To design a PLA, all that's needed is a description of the required sequential-logic operations in the form of Boolean equations. These equations are processed by computer, resulting in an automatically drawn mask for the oxide removal.

TI expects the first applications to be in process control. However, MOS marketing manager Dave Roop points out that the IC's are also suitable for such applications as calculators, digital terminals, and as a replacement for relay logic—any application, in fact, requiring slow random logic.

Two versions of the PLA are currently available. The TMX-2000JC accepts 17 inputs and provides 18 outputs; the TMX-2200JC has 13 inputs and 10 outputs. In addition, there are internal differences between the two types. Both, however, have similar internal organization: First, the input signals are

applied to a product matrix. For example, the signals I_1 and I_2 might be combined into the products $P_1 = (I_1 I_2)'$, $P_2 = (I_1 I_2)$, as shown in the diagram on page 134. These products are then fed to another matrix where they are combined according to the logic equation, for example, $F = P_1 + P_2$, etc. Actually some of the outputs of the product-combining matrix can be fed back to the product matrix to provide additional logic capability. Thus, the product

Q_1 , for example, could be recirculated and used to form another product $P_3 = (I_1 I_2 Q_1)'$. This feedback is accomplished via a group of JK flip-flops. The TMX-2000JC provides 16 feedback lines to the flip-flops. The TMX-2200JC provides 72 product terms and 10 feedback lines. Flip-flop operation is controlled by a single clock and a common flip-flop-reset input.

Buffers. A special feature of the PLA's is their npn bipolar-transistor output buffers which provide

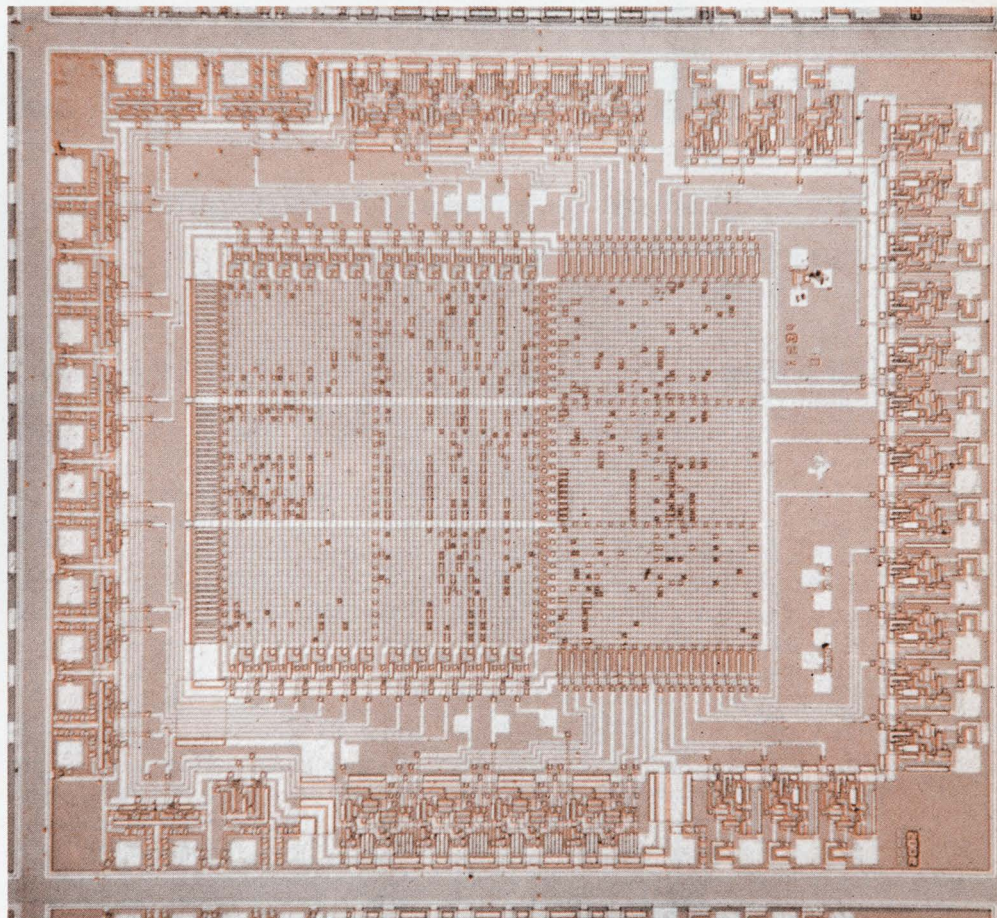

PLA circuit. Product matrix is the rectangle to the left of center and product-combining matrix is at right center. Flip-flops are at the top of the chip and the output buffers, which are bipolar, are at right.

the voltage and current level required by transistor-transistor logic and diode-transistor logic. The manufacturer reports that combining bipolar transistors with MOS transistors on the same chip presented no special difficulties, largely because high-speed performance isn't expected. The specified clock rate is 200 kilohertz.

The IC's have an equivalent complexity of 130 gates on a 162-by-144-mil chip. The matrix regions alone contain 5,000 devices. Both arrays come in ceramic DIP's.

Price for the TMX-2000JC is \$35 in 1,000 quantities, \$30 for the TMX-2200JC. There is no mask charge for orders of 1,000 or more; in lesser quantities the mask charge varies from \$1,000 to \$3,000.

Texas Instruments, Inquiry Answering Service, P.O. Box 5012, MS 308, Dallas 75222 [338]

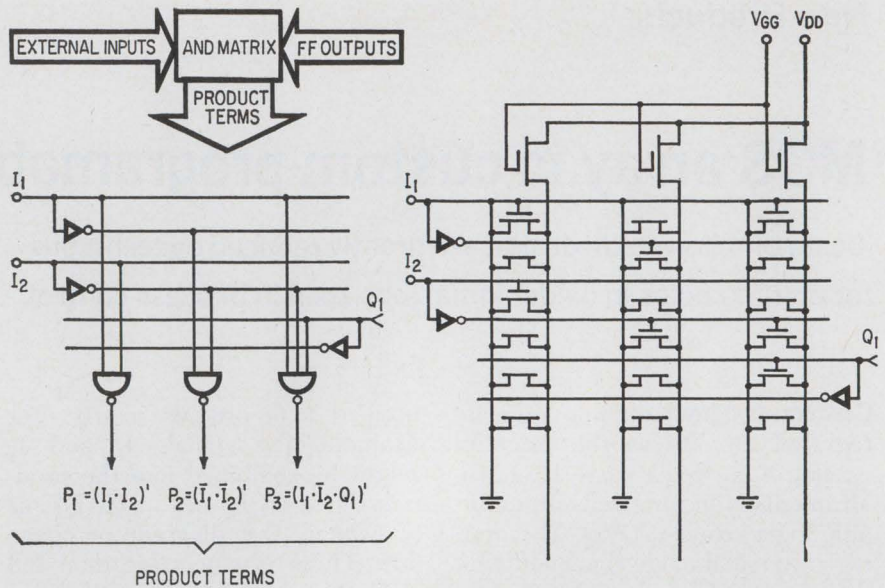

Product matrix. External inputs such as I_1 and I_2 and flip-flop outputs such as Q_1 are combined in the product matrix to form products such as P_1 , P_2 , and P_3 . To connect signals according to the required logic program, metalization forms gates of MOS transistors as shown at right.

Displays

Monolithic numerics go to market

Seven-segment readout aimed at glow-discharge tube business, plus jobs in portable, lower-power applications

The promise of an inexpensive, all solid state seven-segment digital readout has been exciting the electronics industry for some time, and it has finally been fulfilled in the form of the MAN from Monsanto. MAN-3 is a monolithic gallium arsenide phosphide light-emitting diode array that will sell for under \$3 in large volume.

Besides the usual applications for digital readout devices, the MAN-3 "will open up new areas such as truly portable, battery-powered instruments and low-power, high-reliability displays for the military," says Clarence Bruce, director of marketing for Monsanto's Electronic Special Products division. Each segment will produce 200 foot-lamberts of bright red light with an input current of only 5

milliamps, or 400 foot-lamberts at 10 ma. Bruce points out that the brightness level of a typical desk top is 50 foot-lamberts, so that in desk calculator applications, for example, the lower figure will be more than adequate.

Each of the seven segments consists of five active areas. The line width is 1.5 mils, but because of the optical effect of red light on a black background, the lines appear to be 10 mils wide. And the overall characters, which actually are 1/8-inch high, appear more than double their size. In all, the unit contains 35 monolithic diodes and one extra for the decimal point.

The device's packaging is both functional and economical. The monolithic chip (and the decimal-point diode) are mounted on a lead

frame, and the unit is encapsulated in clear epoxy after a wire bonding operation. Bruce says there is no need for a hermetic sealing layer because gallium arsenide phosphide is not affected by moisture as is silicon. Besides, if a sealing layer were to be added between the chip and the epoxy, it would have an adverse effect on both the light transfer and heat transfer characteristics of the package.

Four different units are being offered. The MAN-3 is a single array in a single package. Prices for the MAN-3 range from \$12.45 for one unit to \$2.50 each if 100,000 are ordered and delivery is taken within 12 months. The MPC-1 consists of a MAN-3 on a small printed-circuit card and costs \$13.95. The MPC-2 is a three-unit display; the MPC-3

... LED arrays compete favorably with tubes in display density as well as power needs ...

has six units. These are priced at \$35.80 and \$69 each, respectively. In the multidigit units, the arrays are mounted on 200-mil centers which allow up to 16 digits to be packed in only three inches.

The MPC-3 is wired so that only 14 leads are required for the six digits—a multiplex scanning system

years." Although the monolithic array has just been announced, Monsanto has been making custom monolithic arrays for some time, but the pricing for these custom units is higher—\$5 per dot, \$250 setup charge and a minimum order of \$1,000.

As for using the arrays, Bruce

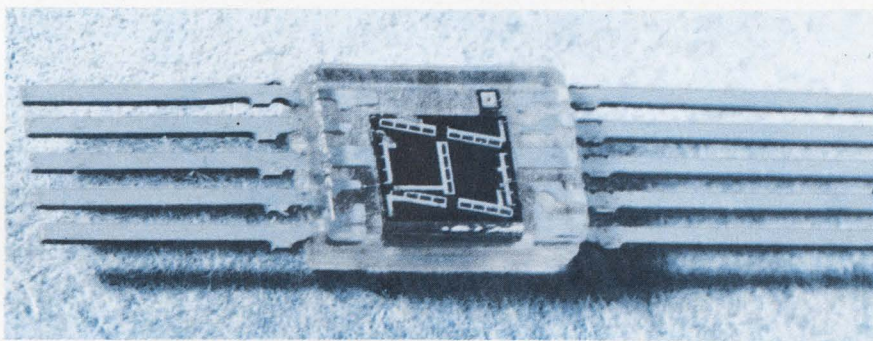
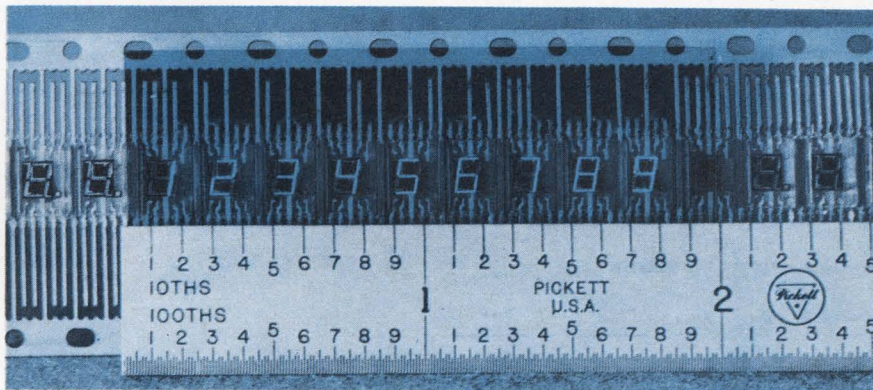

Compact. An array of digits (top) is shown on a lead frame assembly. A single MAN-3 (bottom) is covered with clear epoxy for protection.

is used. Bruce says a decoder/driver integrated circuit, called the MSD-101, that will accept a binary-coded decimal input and also provide a lump test function, will be available soon.

One reason for Monsanto's jump on the competition in the monolithic LED array market might be that it's also the leading supplier of GaAsP wafers to the industry. And the Electronic Special Products division had the help of the R&D people in the materials lab. Bruce says that experience also helps: "We've been working with gallium arsenide phosphide for about nine years, and we've been producing devices for about five

says that "electrically, the MAN-3 is easier to design with because it requires only 8 milliwatts per segment compared to about 56 mw for a gas tube. But besides this, they are also the nicest looking units on the market." One area where gas tubes can't compete, Bruce says, is in replacements for crt readouts where three or four lines of numbers are required—the LED arrays can be placed on top of each other with one-inch spacing from center to center. Thus, five lines of 20 digits each can be placed in a five-by-five inch area.

Monsanto Electronic Special Products, 10131 Bubb Road, Cupertino, Calif. [339]

Aces for the Bridge Game

1.5 Ampere Single-Phase Silicon Bridges 50 Thru 600 PRV

Immediately available from authorized General Instrument Distributors

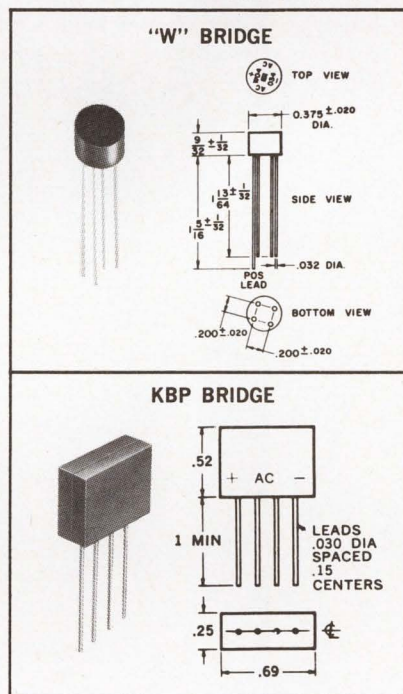

PRV	TYPE	1-99	100-999	1000
50	W005 KBP005	\$.88	\$.60	\$.51
200	W02 KBP02	.93	.62	.53
400	W04 KBP04	.98	.65	.56
600	W06 KBP06	1.03	.69	.58

ALSO AVAILABLE: 3, 5 and 10 Ampere Single-Phase Bridges and 5 and 10 Ampere Three-Phase Bridges.

Write for General Instrument's "Full House" Condensed Catalog and detail bulletins to: General Instrument Corporation, Semiconductor Assembly Division, 65 Gouverneur Street, Newark, N.J. 07104



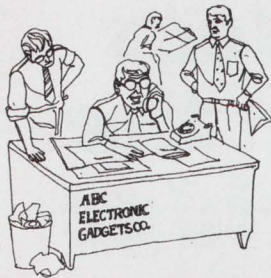

**Call RCA
for tunnel
diodes.
They're stable,
they're available
off the shelf.**

RCA tunnel diodes offer prime advantages of immediate availability plus remarkable stability proved by over a million device-hours of testing.

Note these outstanding characteristics: low capacitance, high I_p/I_V ratios, mechanical ruggedness, improved thermal resistance, uniformity — all achieved through an RCA process of epitaxially-grown junctions. Check the chart for key parameters.

Added features: the gold-plated leads require no pretinning for soldering efficiency. And the package lends itself well for high-volume PC-board mounting operations. Use RCA tunnel diodes especially in your high-speed switching and high-frequency signal-processing applications.

See your local RCA Representative for more information. Or call your RCA Distributor—he's fully stocked. Special selections are yours if you need them. For technical data on specific types, write: RCA Electronic Components, Commercial Engineering, Section CSN-30 Harrison, New Jersey 07029. In Europe: RCA International Marketing S.A., 2-4 rue du Lièvre, 1227 Geneva, Switzerland.

Type	I_p (mA)		I_p/I_V	C (pF)		tr (ps) Typ.
	Min.	Max.		Min.	Max.	
40561	4.5	5.5	6/1	25	1800	
40562	9	11	6/1	25	900	
40563	18	22	6/1	30	600	
40564	45	55	6/1	40	350	
40565	90	110	6/1	40	150	
40566	4.75	5.25	8/1	15	1200	
40567	9.5	10.5	8/1	15	600	
40568	19	21	8/1	20	400	
40569	47.5	52.5	8/1	25	200	
40570	95	105	8/1	25	100	
40571	4.75	5.25	8/1	8	600	
40572	9.5	10.5	8/1	8	300	
40573	19	21	8/1	10	200	
40574	47.5	52.5	8/1	12	100	

RCA

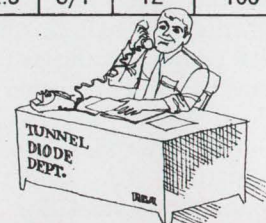

Digital counter is simple—and inexpensive

Designed to replace electromechanical units on assembly lines, this low-priced 3½-digit instrument runs at up to 1 Mhz

Realizing that most engineers don't want to pay for specifications they'll never need, Digilin Inc. has developed a simple, low-priced counter. It isn't up to the specs and versatility of the \$500-and-up counters, but the new device counts up to 1999, has a digital display, fits into a panel—and is priced at \$149.

When they planned the 320,

Digilin engineers set their sights on replacing electromechanical devices used for such industrial tasks as counting products moving down an assembly line. When a transducer, such as a phototube or a pressure-switch assembly, sends a pulse to one of these counters, its solenoid is activated, advancing a numbered-wheel display.

Although the 320 isn't a pin-for-

pin replacement for these units, it works with the same transducers. A 2-volt pulse whose rise time is between 20 and 300 nanoseconds advances the display, and a +2-volt pulse resets the instrument.

Since it's made with IC's and Nixie tubes, not gears and numbered wheels, reliability is a strong point with the 320. Also, it runs at speeds up to 1 million counts



Digital panel meter series DP400 is a 10,000 count d-c voltage measuring device that provides direct digital readout of the value of the applied input voltage. Accuracy is $\pm 0.02\% \pm 1$ count. Three models are available with full-scale input ranges of 1, 10, or 100 v. Price (10-29) of the 100 v full scale model is \$246. Computer Products, P.O. Box 23849, Ft. Lauderdale, Fla. [3611]

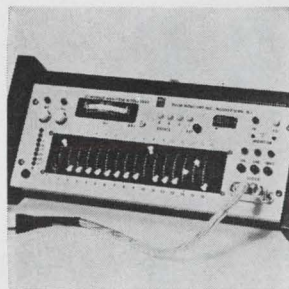

Compact IC/module analyzer model 2080 contains a built-in stimulator, generator, monitor and IC power supply, and eliminates the need for any peripheral test instrumentation. It will test chips with up to 16 pins. Unit measures 16 x 10 x 6½ in., and weighs 16 lbs. It is priced at \$1,290 in small quantities. TeleSciences Inc., 351 New Albany Rd., Moorestown, N.J. 08057 [3621]

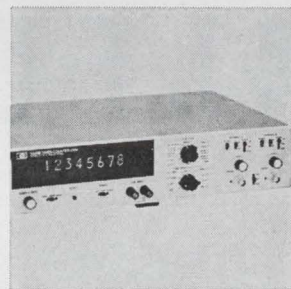

Counter model 5326B is a 50-Mhz unit that can average time intervals. That means it can measure repetitive time intervals as short as 0.15 nsec, and it has resolution as fine as 10 psec. The instrument also has an internal integrating dvm, with which it can measure its own trigger-level settings. Price is \$1,550. Hewlett-Packard Co., 1501 Page Mill Rd., Palo Alto, Calif. [3631]

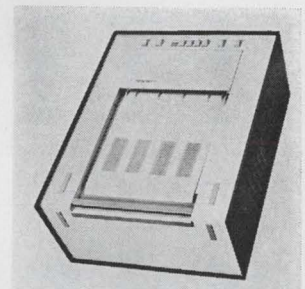

Recorder model 440 has four, 40-mm channels, two event markers, and eight pushbutton-controlled chart speeds. It is equipped with a pressurized ink system that utilizes disposable plastic ink cartridges, and a pen-position servo system that assures 99½% accuracy. Unit weighs 45 lbs. Brush Instruments Division, Gould Inc., 3631 Perkins Ave., Cleveland, Ohio 44114 [3641]



Statistical digital voltmeter designated Solartron model 1860 is for measuring and analyzing parameters of stochastic or deterministic signals. Direct digital display and analog and digital outputs of the mean, mean modulus and true rms value of the signal being analyzed, are provided. Price is \$3,250; delivery, 30 days. Marconi Instruments, 111 Cedar Lane, Englewood, N.J. [3651]

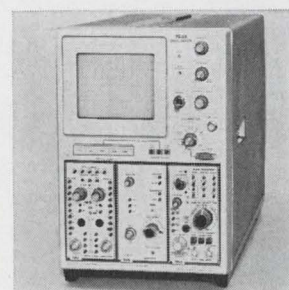

Flexible oscilloscope type 7503 is a 90-Mhz, three plug-in unit with a dual-trace vertical amplifier in the mainframe provided by vertical-mode switching, which enables the user to simultaneously measure waveforms with widely different characteristics by electronically switching between two vertical plug-ins. Tektronix Inc., P.O. Box 500, Beaverton, Ore. 97005 [3661]



Frequency counter-tachometer FT300 is a four-digit panel meter that has five easily changeable frequency ranges and two tachometer ranges with maximums of 1 Mhz and 100,000 rpm, respectively. Features include adjustable display time, overrange indicator, input sensitivity adjustable from 50 mv, and 1-megohm input impedance. Dixon Inc., Box 1449, Grand Junction, Colo. [3671]

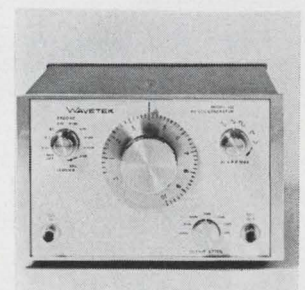

Function generator model 142 features a frequency range of 0.001 hz to 10 Mhz and an asymmetry function. It provides positive- and negative-pulse outputs as well as the usual sine, square, and triangle waveforms. Output frequency can be controlled manually, or by applying a control voltage to the front panel BNC connector. Wavetek, P.O. Box 651, San Diego, Calif. 92112 [3681]

LITTELFUSE LILLIPUTIANS

TINY PERFORMERS IN GIANT JOBS.

All systems are go with High Rel Littelfuse Pico and Microfuses on the job—small components for high reliability. It was that way in the Gemini, Surveyor, and Apollo space programs. It is that way in computer, instrument, and missile, "zero defects" programs here on Earth. The High-Rel Pico and Microfuses have precise blow times, can withstand high temperatures, use minimal space, and are resistant to vibrations and shock.

There is a whole line of High Rel Pico and Microfuses, from 2 milliamps to 15 amps. Littelfuse will gladly quote prices on custom applications for small giants that do the big jobs best.

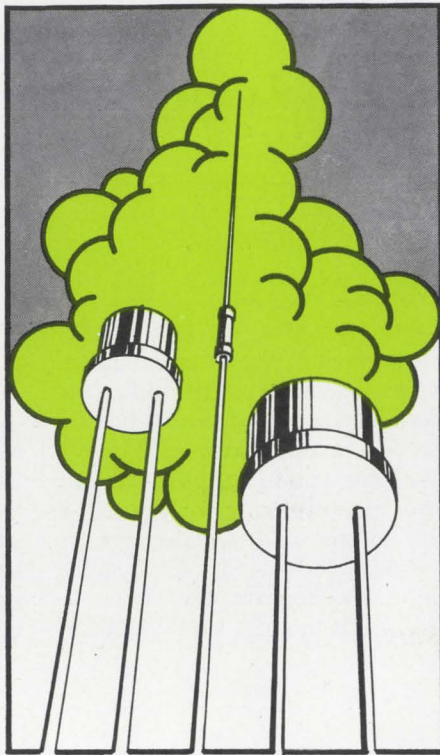

LITTELFUSE

DES PLAINES, ILLINOIS 60016 • SUBSIDIARY OF TRACOR, INC.

Circle 161 on reader service card

REAL TIME SPECTRUM ANALYZER



Frequency Range: 0-10 Hz to 0-6 kHz
 Resolution: 1200 Point Stored Sample
 Dynamic Range: 45 dB
 Price: Model 2002- \$9600



BARRY RESEARCH

934 E. MEADOW DRIVE • PALO ALTO, CALIF 94303
 PHONE 415 321-6800 TELEX 348 329



Joiner. Since it has a BCD output, this counter can be connected to other digital equipment.

per second. "With a mechanical counter, if you start getting 10 counts a second, you're really clipping along," says Eugene Hibbs, president of Digilin.

Another feature of the 320 is its binary-coded-decimal output, which allows it to be connected to digital recording or control gear.

The 320 is 3 by 4¼ by 3 inches and draws 7 watts.

Digilin, Inc., 6533 San Fernando Road, Glendale, Calif. 91201 [369]

New instruments

Data terminal runs the show

Teletype plus control logic form command center for automatic test systems

"I just want to sell more of those boxes," says Loebe Julie, explaining why his company, Julie Research Laboratories Inc., is moving into the digital-control field. "Those boxes" are the high-resolution bridges and potentiometers that Julie has long been building. When the company started making its products programable, Julie found that few of his customers could take advantage of this feature, because they lacked the needed interface gear. The only things around, he recalls, were simple data loggers and expensive computer systems.

Julie's remedy for this situation

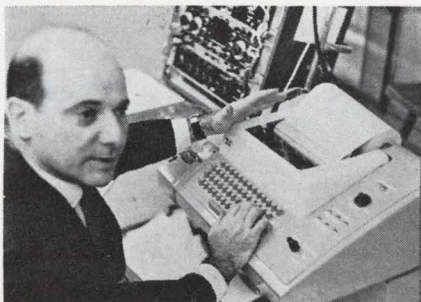

Speed writer. Test programs for the 106 data terminal can be written in less than an hour.

is the ATS-106/20, a data terminal and interface that either controls instruments itself or links them with a computer. The 106 is a standard Teletype with a bank of special logic networks built into its chassis. These networks convert binary-coded-decimal and 10-line-decimal signals into ASCII-coded signals, and vice versa; send commands to the instruments; read their response; and print test results in any format.

To build a system around the 106, a user first assembles the needed instruments; the 106 works with any programable devices, Julie-made or not, and can be directly connected, without buffering, to those that work at diode-transistor- and transistor-transistor-logic levels. The system can have as many as seven instruments, that being the maximum number of measurement outputs that the 106 can handle. It can adjust as many as five instruments.

After building the system, the user writes a program, which can take from 10 minutes to an hour depending on its complexity.

The 106 has four operating modes. In MANUAL, the 106 does nothing; the operator adjusts and reads the instruments.

MANUAL-RECORD means the operator adjusts the instruments while the 106 prints the results, and also puts them onto a paper tape, which runs the system while the 106 is set to AUTOMATIC.

In COMPUTER, the 106 relays commands to the instruments and sends measurements back to a computer.

The 106's price is \$19,400; delivery time is three months.

Julie Research Laboratories Inc., 211 W. 61st St., New York 10023 [370]

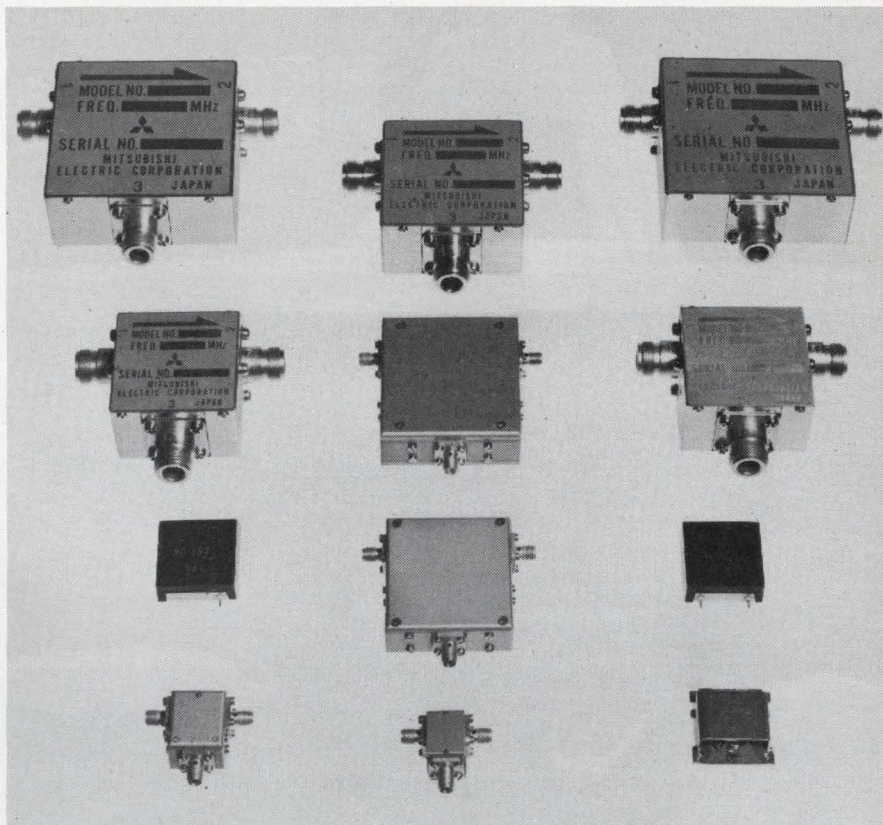

Thanks for Visiting the Mitsubishi Booth

We extend our sincere appreciation to all those IEEE Show visitors who took the time to stop by the Mitsubishi Electric booth. The enthusiastic interest shown in the displays was especially encouraging. We are glad to be able to report that our monolithic ICs and mini circulators—VHF, UHF, and SHF, as well as the 700 MHz type—were all favorably received.

Now that the show is over, we welcome any further inquiries from you about the new research developments and techniques.



Circle 139 on reader service card

XENON corporation DC XENON & KRYPTON ARC LAMPS

39 commercial street • medford, massachusetts/02155 • (617) 395-7634

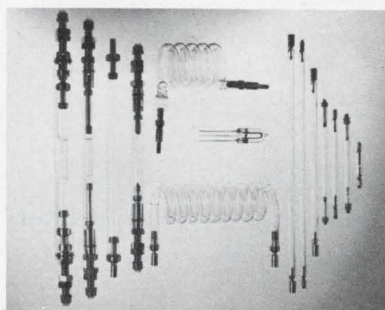

FLASHTUBES & ARC LAMPS

TYPICAL DESIGNS:

- Linear
- "U" Shaped
- Air Cooled
- Helical
- Water Cooled
- Annular

TYPICAL APPLICATIONS:

- Strobe Photography
- Copying Machines
- Computer Printing
- Pulsar "UV" Bleaching, Fusing & Curing
- Laser Pumping
- Beacon Lights
- Photo Chemistry

AVAILABLE IN SOLDER SEAL OR GRADED SEAL PACKAGE

• FREE FLASHTUBE CATALOG ON REQUEST •

Specialists in the Generation of Light

NEC covers the world

It's a small world.

Japan's largest electronics/telecommunications manufacturer makes it smaller. Daily.

NEC products and projects—from satellite communications to computers and IC components—are covering the world.

Examples:

Trailer trucks transport NEC NC-23 Switching Systems. In Canada, the USA—with complete compatibility. Other crossbar customers include Brazil, Korea, India and more. Proofs that **NEC crossbars the world.**

First of its kind: NEC's 240-channel 2GHz Radio PCM. Just one of NEC's innovative firsts in Pulse Code Modulation technology. Customers in Mexico, Australia, Thailand, Belgium prove that **NEC PCM's the world.**

NEC's "Oh Nine" (NA4-09) PABX expands telephone capacity from 50 to 400 lines. Start with 50. Add up to eight 50-line units as your business grows. Plug-in method, compact, light-weight design save money and floorspace. Proofs that **NEC telephones the world.**

Largest contract awarded one firm: NEC's Iran microwave network: a 3,557-km, 83-station system. NEC's 70% share of Brazil's 7,100-km network, plus Mexico's solid-state system prove **NEC microwaves the world.**

Radio PCM

Microwave Antenna

NC-23

(NA4-09) PABX

Products for today—
Innovations for tomorrow

NEC

Nippon Electric Co. Ltd. Tokyo, Japan

Overseas Offices: Taipei, Manila, Bangkok, Djakarta, Kuala Lumpur, New Delhi, Karachi, Teheran, Beirut, Melbourne, Düsseldorf, Mexico City, Rio de Janeiro, Bogotá, New York, Chicago, Los Angeles.

Main Products: electronic computers, data communication systems, telephone systems, carrier transmission, radio communication, radio & television broadcasting, satellite communications equipment, electrical household appliances, other applied electronic equipment, and electronic components.

Bonder indexes automatically

Precision mechanism allows bonding without visual alignment of wire and pad

The major innovation in a new thermocompression bonder from D.P. Veen Co. is use of a ball-bearing slide in the work mechanism, rather than the traditional lever arrangement. The slide virtually eliminates excessive play in the mechanism, so that circuits can be bonded with a template, without having to look through the microscope. Chips, of course, must be

accurately positioned, but this is a fairly simple procedure.

John C. Diepeveen, president of the firm, also has introduced the sine motion to his process. The principle applies to the wire's motion—following a pure sine curve instead of a strictly vertical movement, and to its speed—a slow-fast-slow timing rather than only one speed. The slow starting and stop-

ping speeds help eliminate bounce and overshoot, and the fast intermediate speed makes the overall bonding time quicker.

The problem of wire rippage also is alleviated through the sine motion. A smaller wire may be used—7/10 mil instead of 1 mil. A thinner wire makes it possible to use a smaller ball, then a smaller pad and smaller chip, and finally

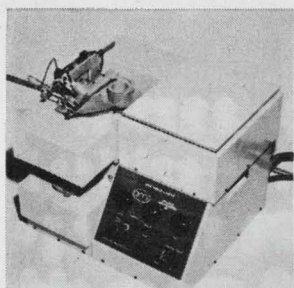

Automatic system DH-F-VIL-10 probes and sorts diode dice or wafer capacitors at speeds to over 4,000 per hour. It incorporates linear and circular feeders with vacuum-transfer and probe nozzles. Parts are placed in test nest, probed, and upon signal from test set are gently air ejected into the appropriate category. Affiliated Manufacturers Inc., Box 248, Whitehouse, N.J. [421]

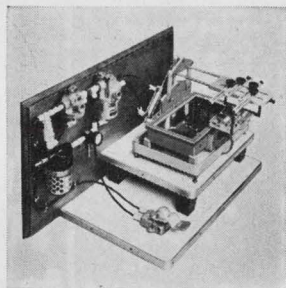

Portable soldering machine speeds dip soldering of p-c boards and tinning of IC leads. It adjusts to fit any size and shape p-c board up to 5½ x 11 in. More than one board can be handled at a time. Arms of the unit extend away from the solder bath for easy loading and unloading. Temperature can be regulated to 650° F. Dextronix Corp., Box 337, Cornwallis Heights, Pa. [422]

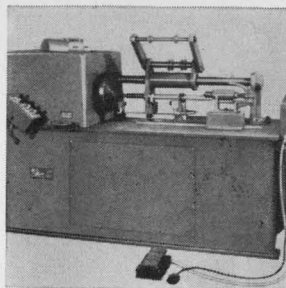

Gearless, heavy duty, multiple transformer winder model 500-AM features instant spiral/rapid traverse, wire size range 10-28 Awg, 14 in. max. coil o-d, 12 in. max. coil length, 30 in. max. loading distance for multiple winding, 8-75 turns-per-in. winding range, 0-to-250-rpm winding speed. Price is \$8,600; delivery, 8-10 wks. Geo. Stevens Mfg. Co., 6001 N. Key-stone Ave., Chicago [423]

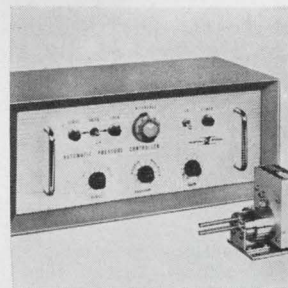

Automatic pressure controller series 213 provides increased yield and better reproducibility from run to run in sputtering and reactive evaporation processes. Steady pressure control of doping gases makes it useful in preparation of semiconductors. Control has been achieved from above 1 atmosphere to less than 10⁻¹¹ torr. Granville-Phillips Co., E. Arapahoe Ave., Boulder, Colo. [424]

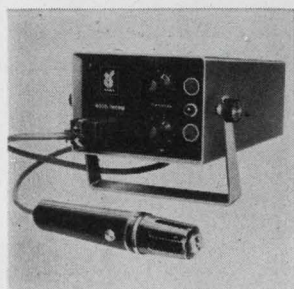

Rotary thermal wire stripper model RT-1 features centrifugal-force insulation severing that ends conductor damage. It will strip most insulations used in electronics manufacturing including Teflon and Kapton without damage to even hair-like No. 40 strands. Wire diameters are No. 40 to 0.300 in. Roto-Therm Division, Republic Corp., 950 N. Sepulveda Blvd., El Segundo, Calif. [425]

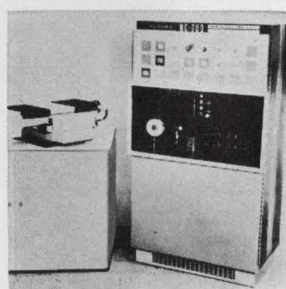

XY positioning tables are designed for use with numerical controls or stepping motors. They are adaptable to a variety of production operations including laser drilling, trimming and cutting, welding and soldering, circuit board drilling, back-panel wiring, component insertion, and light machine drilling and tapping. Hughes Industrial Systems, P.O. Box 92904, Los Angeles [426]

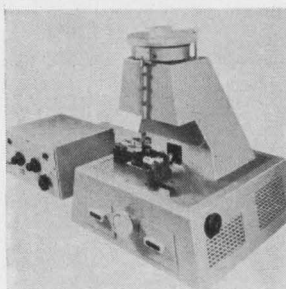

Automatic core handler X-13 is used with a core tester to electrically test 14 to 30 mil o-d ferrite-memory cores at rates from 200 to 1,300 cores a minute. The combination provides a complete test system. The handler transports the core to a test station where programed current generators determine acceptability. Horex Electronics Inc., 21st St., Santa Monica, Calif. [427]

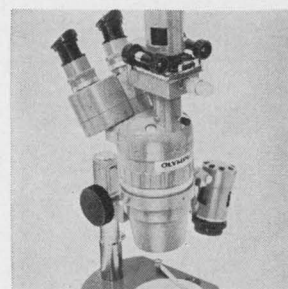

Hybrid-circuit production and inspection time is cut 50% by a new stereo-microscope system. The Infoscope projects circuit diagrams, waveforms or digital displays into the bonding operator's or inspector's field of vision. This permits checking assembly accuracy and performance without looking away from the eyepieces. Olympus Corp of America, Nevada Dr., New Hyde Park, N.Y. [428]

METALIZED POLYESTER CAPACITORS

ACTUAL SIZE



M2W
SERIES

ANY SIZE, VALUE,
VOLTAGE AND
TOLERANCE

to your exact
specifications...
at stock prices

Unique, self-healing units that remain in circuit during voltage surges with little or no loss of electrical properties. Use the M2W's where size and weight are limiting factors and long life and dependability are required. The units utilize metalized Mylar* Dielectric with film wrap and custom formulated epoxy resin end fill. Available in round and flat styles.

*Du Pont Trademark for Polyester Film

Samples available on
your letterhead request



CONDENSER CORPORATION

Dept. EL-3, 1065 W. Addison St.,
Chicago, Ill. 60613 • 312-327-5440

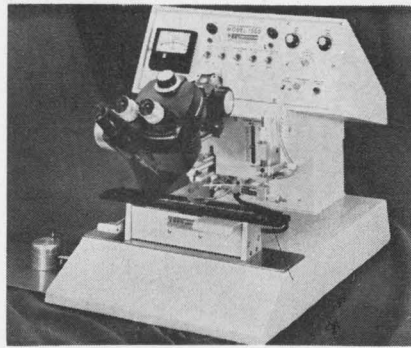

Convenient. Bonder controls are all in front, for easy adjustments.

a less expensive chip.

While the speed portion of the sine motion automatically remains the same over the complete range of height adjustments, Diepeveen has inserted an intermediate search mode (between the first and second search) that allows for an adjustable loop control. Wire loop height thus is determined by this intermediate level control and the wire drag is applied. Another feature of Diepeveen's unit is its positive/negative capability: it can bond up or down to a pad or post.

The design configuration of the machine gives it greater flexibility. It has a plug-in timing module which is easily replaced; a defective one can be returned to the factory without sending the entire main frame. The Diepeveen unit also features overhead construction, with a deep throat over the work table. Thus the machine is able to handle large hybrid circuits that are too big for other bonders. Diepeveen notes that previous units have had inconvenient adjustment controls, or none at all; he has placed all of the controls at the front of the unit, making the machine completely adjustable from the operator's work position.

According to Diepeveen, the range of work motion in most bonding machines is a 3/8-inch-square area. In his standard model, the range is one inch by one inch, and it can be increased to two by two. The resulting wider field leads to a reduction in indexing time.

The basic unit will sell for \$3,350. Not included in the price are the work stage (made to specification), optics, bonding tip, and the bonding-tip heater.

D.P. Veen Co. Inc., 1026 W. Evelyn Ave.,
Sunnyvale, Calif. 94086 [429]



**One answer
for the critical
silicon shortage
is 300 years old.**

Algernon Sidney (1622-1683) said, "God helps those who help themselves." And production problems caused by the short supply of silicon can end with your own in-plant facility for crystal growing, zone purification or proprietary IC production.

Count on NCG for the industrial gases you'll need. We produce hydrogen and nitrogen for use in crystal growing. Our argon and helium provide inert atmospheres for zone purification as well as production of silicon, germanium or ICs.

NCG reliably supplies any quantity of these gases from a single cylinder to a neighboring air separation plant built and operated by our own personnel. Write to us for complete details.

NCG[®]

NATIONAL CYLINDER GAS
DIVISION OF CHEMETRON CORPORATION
840 North Michigan Avenue • Chicago, Illinois 60611

CHEMETRON

TRADEMARK

put your stake in Florida.

We Have Competitive Advantages You Simply Can't Afford To Overlook

When your surveying team pounds the first stake into the good Florida earth you'll be off and running.

Florida has competitive advantages for you that are bound to find their way into your profit and loss statement.

Our recently passed laws governing revenue bond financing are going to smooth the pathway to new building and improvement.

We have a labor training and motivating program — without cost to you — that takes all the headaches out of recruitment.

The all-'round advantages of Florida living make us the **most** attractive state for all kinds of skilled people.

When you start thinking about sites, think about Florida where you get the big competitive edge. Phone (904) 224-1215, or send the coupon.

Florida

FLORIDA DEPARTMENT OF COMMERCE
INDUSTRIAL DIVISION
107 WEST GAINES STREET
TALLAHASSEE, FLORIDA 32304

HANDY COUPON FOR YOUR CONVENIENCE!
Florida Department of Commerce / 107 West Gaines
St. / Tallahassee, Florida 32304 / Att.: Dept. "D-2"

I'm interested in a business or industrial future
in Florida. Please send me more information.

Name

Title or Position

Company

Street

City State Zip

Using spot ties?

GUDE-TIES, replacing plastic wraps, cut yearly material cost more than 75%

"GUDE-TIES", CUT LENGTHS of Gudebrod Flat Braided Lacing Tapes, are specifically produced for spot tying—in production harnessing or for on-site work. A comparative engineering analysis found that material costs for Gude-Ties was 76.7% less than for plastic wraps on a yearly production basis, and harness weight was reduced also. In aviation and other important applications weight of the harness is important, and gaining more importance. Gude-Ties are dispenser packaged for one hand, easy withdrawal. Meet MIL-T Specs, make firm knots. Available in 6", 8", 10", 12", 15", 18", 20" and 22" lengths (other lengths to order).

Try GUDEBROD'S SYSTEM "S"

In spot tying when you combine Gudebrod Gude-Ties with Gudebrod Gude-Snips and the Gudebrod Swivel-Tilt Harness Board Mount you're really streamlining the production of wire harnesses. Gude-Snips, palm-of-the-hand snips cut cleanly, easily—right or left hand. Spring action, Du Pont Teflon bearing. Eliminate constant reaching for knife or shears. The balanced, three dimensional action of the Gudebrod Swivel-Tilt Harness Board Mount brings every section of the harness within easy, comfortable reach.

Cuts fatigue — speeds work. Ask for full information about Gudebrod System "S" for spot tie lacing. (For continuous tying, ask about System "C".)

Gudebrod Swivel-Tilt
Harness Board Mounts
available in several sizes

1870—100 Years of Quality—1970

G UDEBROD

Electronics Division

GUDEBROD BROS. SILK CO., INC. Founded 1870, 12 South 12th Street, Philadelphia, Pa. 19107

Modems talk to computers by wire or i-r

Intertran, using twisted pairs, and Optran, with an infrared beam, can operate at data rates up to 250,000 baud to connect terminals to computer for distances up to two miles

The demand for short-range, high-speed data-communications links is increasing as more and more remote terminals spring up around computer installations. Previously, these links were restricted to using telephone lines and telephone-company equipment. However, the Computer Transmission Corp. is offering data-set users a less costly method of remote connection to a

computer. Their device is called Intertran—a data set that can transmit up to 250 kilobits per second.

Intertran is designed for use with twisted-pair, four-wire facilities to transmit data up to two miles. The new data set uses a phase-modulation technique that CTC president Ray Sanders says is quite new. This modulation approach uses a phase-locked loop where basic car-

rier synchronization is essentially instantaneous. In other words, there is no required timing period which occurs prior to data read-out. "This technique buys simplicity, reliability, and low cost", says Sanders. The CTC data set uses medium-scale-integrated circuits with the emphasis on transistor-transistor logic.

On the user side of the line, In-

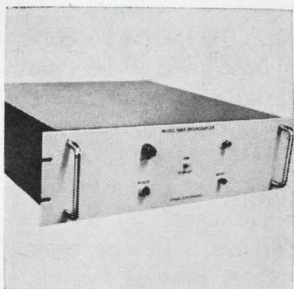

Universal intercoupler 709A is designed to simplify problems of digital data coupling between many different system components. It can be used to interface with virtually all digital data sources such as voltmeters and counters, to output media like punched tape, punched card, computer mag tape, and teletypewriters. Spiras Systems Inc., 322 Second Ave., Waltham, Mass. [401]

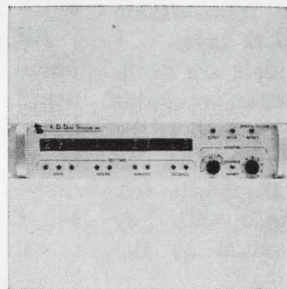

Digital clock series 015 is designed not only as a visual display of time but to easily integrate into complete data handling systems. All time data is available on a rear connector; integrated circuit BCD levels and a time interval can be selected from the front panel switches for system control. Analog Digital Data Systems Inc., 830 Linden Ave., Rochester, N.Y. [402]

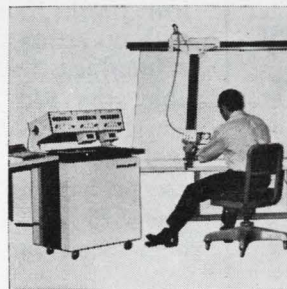

Auto-trol digitizer model 3800 converts graphic data to digital form for input to computer programs. Precise x and y coordinate values are recorded by operator command onto punch cards, paper tape, magnetic tape, or computer terminals in operator-wired formats compatible with customers' computer program. Auto-trol Corp., 6621 W. 56th Ave., Arvada, Colo. 80002 [403]

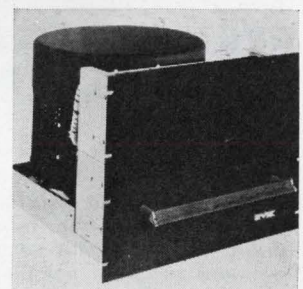

Disk memory system model 8504 offers low cost per bit. Features include data storage of 6.4 million bits, 128 data tracks, 50,000 bits per track, 1.46-Mhz bit transfer rate, and an average access time of 16.6 msec. Additional features of the system include a special nickel-cobalt plating to ensure longevity of data storage. Magnafile, 2603 E. Magnolia, Phoenix, Ariz. 85034 [404]

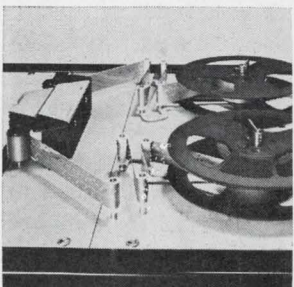

Paper tape spooler accommodates 5-8-track paper or mylar tape at bidirectional speeds to 1,000 characters/sec and rewind speeds to 1,000 characters/sec. The high reliability and ruggedness is suited for numerical control, ground support systems, test equipment, digital data handling, and computer input. Datascan Inc., 1111 Paulison Ave., Clifton, N.J. 07013 [405]

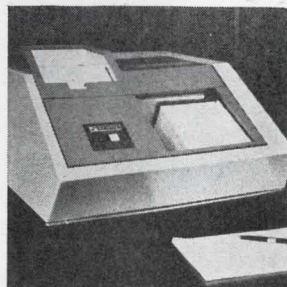

Card reader SR-600 maintains a rate of 600 80-column cards each minute or 750 51-column cards each minute. As an intermediate speed card reader, it comes as a table unit offering simplicity of operation. Unit weighs 125 lbs, has a hopper capacity of 1,400 cards and a stacker capacity of 1,000 cards. Data Products Corp., 6219 DeSoto Ave., Woodland Hills, Calif. [406]

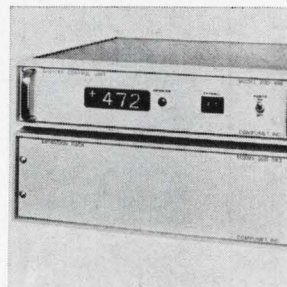

Modular, solid-state, fully expandable system designated series 200 is for sampling low-level analog inputs and converting them to digital output data and a descriptive title requiring three typed lines. It eliminates isolation between channels and earth ground, and common- and normal-mode noise rejection. Compumet Inc., 6911 Topanga Canyon Blvd., Canoga Park, Calif. 91304 [407]

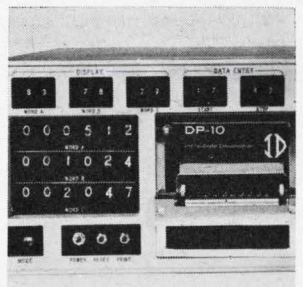

Digital display and printout DP-10 has real-time decimal display. It contains a MOSFET temporary memory storage system enabling the operator to select any three data words from a data frame being recorded by Mark II and display either as a 6-digit decimal word or as printed record in decimal form on 3-in. paper tape. Incre-Data Corp., Acoma Rd., S.E., Albuquerque, N.M. [408]

Send us your precious metal scrap...



we'll squeeze out every last bit of Au, Ag, Pd, Pt.

From the moment we receive it, your scrap gets handled with care. Witness our careful sampling methods: we mix your *entire* shipment, fire assay two or more separate samples (and stash away yet another—sealed—in our vault for your future reference), and chemically separate out each precious metal. Then we send you the good news.

Handy & Harman has been refining its own precious metal scrap for a hundred years—as prime refiners we know how to squeeze out the last bit of gold, silver, palladium, and platinum. We refine our own scrap, we refine Government scrap, and we'd like to extract full value from yours. We have a booklet that covers the subject; please write for it. After all, your scrap may be worth its weight in gold.

Please send your booklet about precious metal scrap.

Name _____
Title _____
Company _____
Address _____
City _____
State _____ Zip _____

HANDY & HARMAN
850 Third Avenue, Dept. EL-14,
New York, N.Y. 10022



... data sets can take care of local hookups without use of telephone lines ...

tertran will look exactly like Bell's 303 data set—the unit it will more than likely be communicating with on the other side of the line. However, on the line side, the two are quite different since the 303 data set uses a modulation format compatible with wideband channel usage—the 303 can operate at data rates up to 460.8 kilobits/sec.

“Intertran is ideally suited for use in banks, universities, and the aerospace industry, or for that matter any place where a remote terminal has to be hooked up to a computer”, says Sanders. An example of Intertran's use would be the connection of an IBM 360/20 to a larger IBM computer, such as the IBM 360/40, 360/50, or 360/91. Testing at CTC has yielded excellent results, namely transmission with no errors, Sanders says.

Interface. Two models are available: the 915 Intertran operates into a low-speed device such as the Bell 200 series data set. The 915 can perform up to 20 kilobits/sec. The 916 will interface with any high-speed modem—such as the

The internal clock is accurate to $\pm 0.01\%$ while the external clock must be held to $\pm 5\%$ of the specified data rate. Output-power levels are low—both units operate at levels below 10 milliwatts.

The standard unit comes with five input/outputs: send data, serial clock transmit—which synchronizes the signal to any data change of state, receive data, serial clock receive, and data set ready. The last one applies voltage when the power in the data set goes on. Available as options are the following controls: request-to-send/clear-to-send control signals, carrier-on-control signals, and frame-pulse-send/receive signals.

The Intertran model 915 is priced at \$1,875 and the 916 costs \$50 more. Delivery is in 30 days.

Alternative. CTC hasn't forgotten about the customer who can't use twisted wire since he might have to cross a busy thoroughfare or railroad track. For this user, there's Optran—an infrared data set. Optran possesses all the features of Intertran with one exception—its range is limited to half a mile line-of-sight. Since Optran uses i-r, it requires no FCC licensing nor does it present the safety problem that laser data sets do; i-r transmission is held below the critical margin of 10 microwatts per square centimeter within the beam. The bandwidth of the data set is 4,000 angstroms, the center wavelength is 9,400 Å, and it's noncoherent—lasers' coherent-light transmission possess very narrow bandwidths.

As with Intertran, Optran is available in two models—the 1815A at \$2,900, and the 1815B at \$2,950. The optical unit—Optran comes in two parts—is 19 by 12 by 5 inches and is mounted on a pedestal; it can be rotated 360° in azimuth and elevated $\pm 20^\circ$. The interface unit is 10 by 14 by 3.5 inches, the same size as the Intertran unit.

A telescopic sight in the optical device is used for alignment. The interface may be up to 250 feet away.

Computer Transmission Corp., 1508 Cotner Ave., Los Angeles 90025 [409]



Optical link. Infrared transceiver permits line-of-sight communication at distances up to one-half mile.

Bell's 303 series data set—and operates from 10 to 250 kilobits/sec. Units can be ordered for either full- or half-duplex operation and with either an internal clock or provisions for an external one.

The silver market being what it is, can you make do with less in your components?

The silver situation continues "uncertain," except the price, which is probably headed to higher levels.

And so one reflects on his use of silver: can I eliminate it in this wire, this contact? The answer is probably No. Even when silver was \$1.29/troy ounce (Remember?) the reasons had to be pretty good.

Nevertheless, you may be using too much silver.

At Handy & Harman we have observed silver in many guises in our 102 years. And in many electrical/electronic uses we note that *it is the surface of the silver that is doing much of the critical work:* resisting corrosion; resisting wear; conducting electricity.

We propose a straightforward way of reducing silver usage in these applications: our precious metal bimetals. We call them Bimets (succinct, memorable, registered).

The capability is to clad various base metals with a working surface of silver (or gold, or high alloys of either). Many forms and combinations are available. We mention:

Wire. For instance, Bimet 377. 34% by

area fine silver clad copper core. Diameters from .007" to .187" are available. In comparison to a solid fine silver lead wire, there is negligible loss in thermal and electrical conductivity; higher density produces more footage per pound. Edge-rolled flat Bimet wire is also available to replace strip contacts.

Sheet, Strip. Unlimited possibilities for replacing silver contacts—and the fabrication steps that fashioned and affixed them. Silver-plated parts (e.g., slide contacts) are vulnerable to Bimets, too—which are more expensive, but produce savings in greatly increased wear resistance.

Handy & Harman's cladding capabilities are not exhausted by these Bimets de-

signed to reduce silver consumption. Have you heard about our weldable copper? We clad copper (on one or both sides) with a copper alloy. Resistance welding is then fully useful—particularly when you wish to automate your joining process.

The effort to conserve silver and thus save money is not limited to Bimets. The greater use of silver alloys such as Consil 900 (internally oxidized 90Ag-10Cd0) often allows you to reduce the size of your contact as well as increase the life capability of your electrical device.

Are you getting your money's worth out of silver? We will be pleased to answer your questions about our Bimet capabilities. Just ask us.

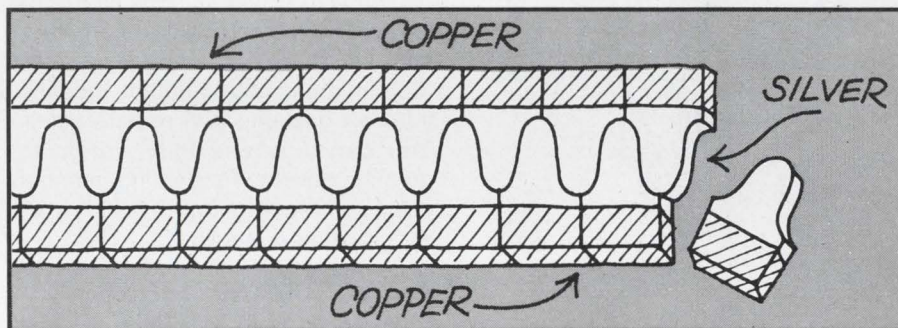

Naturally, you'll ask Handy & Harman

how Bimetals might be applicable for

Application: _____

Name _____ Title _____

Company _____

Address _____

City _____

State _____ Zip _____

Send to: Handy & Harman, 850 Third Avenue, Dept. EL20, New York, New York 10022



Air Gap. Pull. Shape.

The only factors you have to know with this faster method of holding magnet design.

Only three factors are needed for quick, accurate design calculations with this helpful system. This method works because geometrically similar magnet systems have similar characteristics. Specifically, if you multiply air gap and each magnet dimension by the same factor (K) the pull force of the new magnet system will be proportional to K^2 —the area of the new pole face.

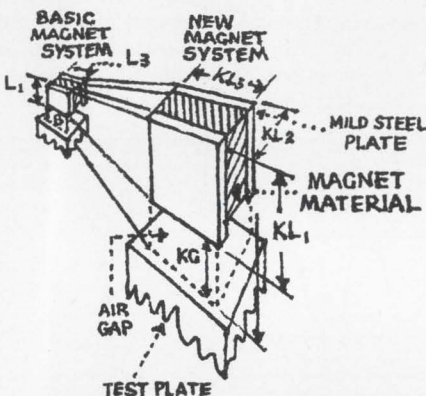

Using this method

In designing a holding magnet with this system you first determine the pull and air gap requirements of your application. From curves showing the performance of several holding magnet designs you then select the basic geometric shape that meets your design needs most efficiently. Since

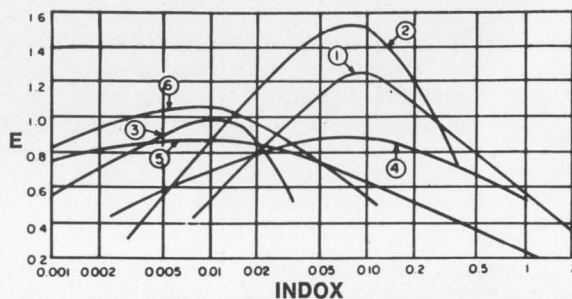

the pull effectiveness remains constant for geometrically similar magnet systems, the effectiveness of your final design can be read directly from the curve selected. The weight of your completed magnet assembly is determined and from this figure you establish the multiplication factor (K) for scaling the selected design. Your completed design now represents the optimum configuration meeting your air gap and pull requirements. You can also use this system to quickly develop a holding magnet design meeting specific size or weight requirements.

A sample calculation

Problem: Design a holding magnet producing a 10 lb. pull at 0.05 inch air gap. The reach factor (G/\sqrt{P}) measures the air gap size for a specific pull. In this example, the reach factor is $\frac{0.05}{\sqrt{10}} = 0.0158$. The effectiveness curves shown here indicate that designs 2, 3, and 6 have about the same effectiveness at this reach factor. Design 2 is selected because it is the simplest in construction. From

the curve for design 2, $E=1.06$. Weight of permanent magnet material required is

$$\frac{(PULL)(GAP)}{E} = \frac{(10)(0.05)}{1.06} = 0.472 \text{ LB.}$$

$$K \text{ IS } \sqrt[3]{\frac{\text{MAGNET WT. REQUIRED}}{\text{MAGNET WT. OF MODEL}}} =$$

$$\sqrt[3]{\frac{0.472}{0.273}} = 1.205$$

Multiplying all dimensions of Design 2 by 1.205 yields:

Diameter = 3.013 in.

Thickness of steel back plate = 0.072 in.

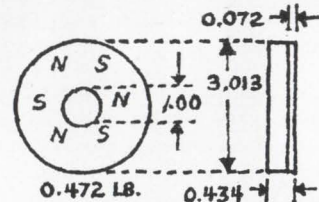

Free design aids

If your design problem has anything to do with magnets and magnetic systems, you can get the information you need at Indiana General. Our engineers are always ready to work with you. For your general reference, we will be glad to send you a complete set of curves for 24 basic holding magnet designs. With these design aids and your slide rule, you can quickly design permanent magnet assemblies for any holding requirement. Just write Indiana General, Magnet Products, Valparaiso, Indiana 46383.

indiana general 

a division of Electronic Memories & Magnetics Corporation

Hybrid current regulators provide 1 to 400 ma

Thick-film units need only one resistor, to set required output; market seen in excitation of crt's, klystrons, magnetic devices

Most engineers who need a current source can make one, using a monolithic IC voltage regulator or operational amplifier, plus two transistors, a diode, and four resistors.

But the monolithic device, no matter what is added to it, is optimized as a voltage regulator, not a current regulator, says George Smith, director of microcircuits

R & D at the Helipot division of Beckman Instruments. The division's microcircuits operation, best known for its line of thick-film hybrid voltage regulators, now is going to market with a current regulator in two models: the 868 (positive) and 878 (negative).

The Beckman units are pre-engineered as current regulators, Smith points out. Only one resistor

has to be added, to set the required output current—this current, in milliamperes, is proportional to the number 2,000 divided by the value of the resistor that is added.

Both the 868 and the 878 accept an unregulated d-c input voltage ranging from 8.5 to 45 volts and furnish a precise, regulated output current in a range from 1 to 400 ma.

Beckman expects the devices

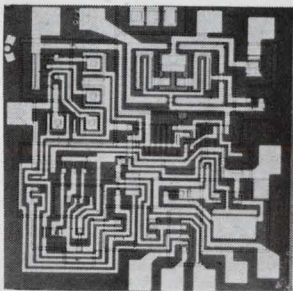

Monolithic voltage regulator type ICB8723C consists of a temperature compensated reference amplifier, error amplifier, series-pass power transistor and current-limit circuitry. Additional npn or pnp pass elements may be used when output currents exceeding 150 ma are required. Price (1-99) is \$4.85. Intersil Inc., 10900 N. Tantau Ave., Cupertino, Calif. 95014 [436]

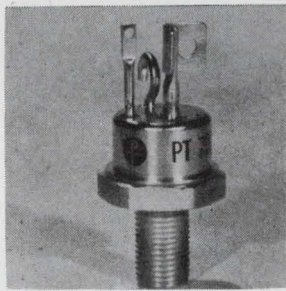

High-current series PT-500 power transistor incorporates a homogeneous base construction for resistance to second breakdown. Units feature collector-emitter saturation voltage to less than 1 v at 100 amps, guaranteed beta to 100 amps, collector voltages to 175 v. All are 100% tested at rated power, 50 v d-c for high reliability. Power Tech Inc., 9 Baker Court, Clifton, N.J. [437]

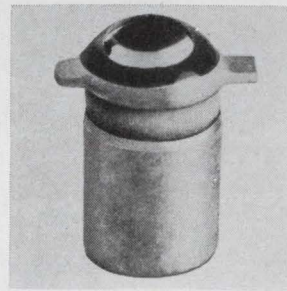

Phototransistors type OP300 will generate light currents in excess of 12 ma at irradiance of 1 mw/cm². With normal light input, the current output is sufficient to function as an IC-logic circuit driver. Units are built in a package that may be mounted on 0.087-in. centers and are suited for IBM system 3 minicard uses. Optron Inc., 1201 Tappan Circle, Carrollton, Texas [438]

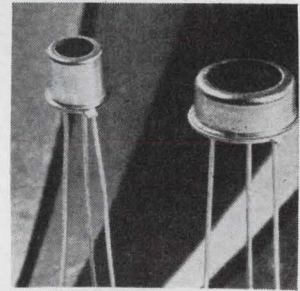

Silicon photodiode SGD-0404 is suited to a variety of applications including: card and tape readers, process control, and remote switching. Typical characteristics include: sensitivity of 0.5 amp/watt at 0.9 micron; spectral-response range from 0.35 micron in the UV to 1.13 microns in the near IR; rise time less than 1 nsec. EG&G Inc., 160 Brookline Ave., Boston [439]

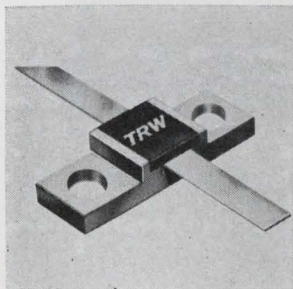

Microwave transistors for S-band equipment provide up to 5 watts output at 3Ghz. The common-base devices come in low-parasitic stripline packages. Source voltage is 28 v. Type PT6669 is rated at 300 mw and 6 db gain. The PT-6636 is rated at 5 watts with 3 db gain. Prices in 100 lots range from \$42 to \$188. TRW Semiconductors, 14520 Aviation Blvd., Lawndale, Calif. [440]

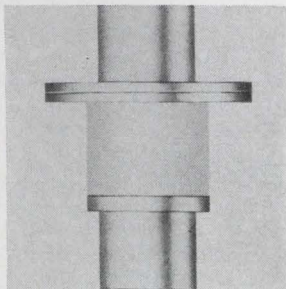

Miniature varactor-tuning diodes series EP are useful for electrical tuning from uhf through microwave frequencies. The series is available with a junction capacitance as low as 0.7 pf through 13.2 pf in nine different types. At 0.7 pf the Q is rated for a minimum of 1,500 at 50 Mhz. Price (100-999) is \$14 each. MSI Electronics Inc., 34-32 57th St., Woodside, N. Y. 11377 [441]

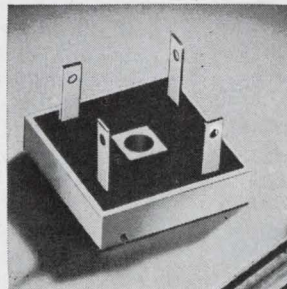

Single-phase, silicon-bridge rectifier model XP409 is for p-c use. Units measure 1 in. square by ¼ in. high, yet are rated for 15 amp resistive - inductive loads. Characteristics at 60 hv include: 8 piv ratings from 100 to 800 v with maximum inputs from 70 to 560 v rms, and a surge current rating of 240 amps max. Sarkes Tarzian Inc., 415 College Ave., Bloomington, Ind. [442]

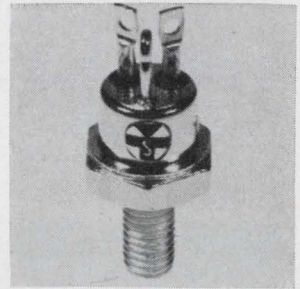

Power transistors JAN 2N2880 and JAN TX 2N2880 are npn silicon triple-diffused devices for power amplifiers and switching uses. Features include: 30 w dissipation capability, low leakage current, 20 Mhz minimum gain cutoff, and low drive requirements. Units are suited for use in h-f inverters and converters. Silicon Transistor Corp., East Gate Blvd., Garden City, N.Y. [443]

will be used to provide current excitation in such applications as driving cathode-ray tubes or special-purpose thermionic tubes like klystrons and magnetrons. It's important to eliminate inrush shock in these expensive tubes, and Smith says the models 868 and 878 can do it. He also looks for them to be used to provide constant current excitation for transducers, including strain gauge bridges, thermistors, semiconductor temperature sensors and pressure transducers, and for excitation of magnetic devices, such as crt focusing or centering coils.

"The ideal current regulator has two critical features," Smith says. "These are very high output impedance and the equivalent of very good line regulation. But the output current should be independent of load and supply voltages." In addition, Smith says the output should be independent of temperature and noise.

The output current tolerance from 1 to 400 ma is $\pm 0.2\%$ (typical) and $\pm 0.5\%$ (maximum). Output current temperature coefficient is typically $\pm 0.005\%/^{\circ}\text{C}$ with a maximum of $\pm 0.01\%/^{\circ}\text{C}$. Output current noise at 25°C , 10 hertz to 10khz, is typically 0.001%.

Input regulation is typically 0.003% (maximum, 0.01%) per volt—an input change of one volt will not change the output current more than 0.01%. Similarly, an output change of one volt will cause an output current change (output regulation) no greater than 0.001% (typically 0.0003%).

The models 868 and 878 are housed in a 10-pin, hermetically sealed, tin-plated package. They are available from stock, and cost \$40 in quantities from one to nine.

Helipot Division, Beckman Instruments Inc., Fullerton, Calif. 92634 [444]

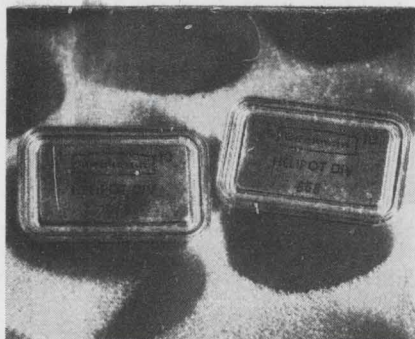

New materials

Epoxy coatings provide r-f shielding

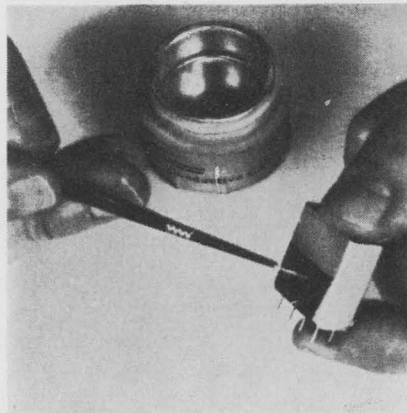

Silver filled, electrically conductive epoxy coatings called Dynaloy 469 (heat drying) and Dynaloy 489 (air drying) can be applied by spray, dip, brush or roller. Both are used for r-f shielding, circuit repair, and conductive inks, depending upon the toleration of a heat cure. Type 489 is available in 3 oz evaluation kits for \$9.50; type 469, in 2 oz kits for \$9.50. In bulk, prices range from \$3 to \$2.20 per oz. Dynaloy Inc., 7 Great Meadow Lane, Hanover, N.J. 07936 [341]

Flame retardant chemical called fire-Master BP6 is for thermoplastics, thermosets, and fibers. It exhibits excellent thermal stability and processes at high temperatures without sublimation. Unreactive in most polymers, it is insoluble in water and many organic solvents. The material should be of interest to switch manufacturers. Michigan Chemical Corp., 351 E. Ohio St., Chicago 60611 [342]

Thixotropic pastes are available for the designer and manufacturer of thick-film electronic devices including film resistors and hybrid circuits. They are offered with temperature coefficient of resistance of 50 ppm from 100 ohms/sq. to 10 kilohms/sq. Cermalloy, Cermet Division of Bala Electronics Corp., P.O. Box 465, Bala Cynwyd, Pa. [343]

Eccosorb CV is a series of premium-quality electrically tapered broadband absorbing materials intended primarily for use in anechoic chambers where superior performance is required at the highest frequencies. It is made from lightweight artificial-dielectric loaded flexible foam. Six types are included in the series having thicknesses ranging from 3 to 18 in. Emerson & Cuming Inc., Canton, Mass. 02021 [344]

Polyester resin, Dolophon CC-1080-1, is designed specifically for trickle impregnation of electrical windings. It has a class H temperature rating and cures from 10% to 20% faster than conven-

tional polyester systems. It also features high bond at high temperatures and low viscosity. John C. Dolph Co., Monmouth Junction, N.J. 08852 [345]

High-Speed, ultraviolet curing, optical cement UV-57 is a single components, photosensitive synthetic resin adhesive. It forms a thermal and impact resistant, glass-to-glass bond with a light transmission of 93% and a refractive index of 1.5316. Trial kits, containing an ultraviolet light source and an ounce of UV-57 optical cement, are priced at \$30. Opticon Chemical, P.O. Box 2445, Palos Verdes Peninsula, Calif. 90274 [346]

Flame retardant electrical insulation called SE/duroid 800FR was developed for terminal board application in tv sets and appliances. It is self-extinguishing in less than 8 seconds. Rogers Corp., Rogers, Conn. 06263 [347]

Glass ceramic paste 4608 is an alkali- and lead-free material designed for cross-over and multilayer applications requiring low dielectric constant, low dissipation factor, and hermetic multilayer packaging capabilities. When brought to firing temperatures (850° - 925°) the glass fuses to form a cohesive adherent coating and then crystallizes to provide a glass-ceramic material with a melting point higher than the original firing temperature. Electro-science Laboratories Inc., 1133 Arch St., Philadelphia, Pa. 19107 [348]

Soldering flux R.8 is for use on p-c boards. It is a clear solution of activated rosin, the activator and rosin-blend having been chosen to make the flux eminently suitable for use on plain copper, solder-plated, roller-tinned, nickel-plated, silver-plated and gold-plated surfaces. Fry's Metals Ltd., Tandem Works, Mertom Abbey, London S.W. 19, England [349]

Thermoset polyimide Gemon-3010, a durable glass reinforced compression molding compound, is recommended for a diversity of electrical and electronic applications where high strength and rigidity are required. Price is \$3.80 per pound. General Electric Co., 1 Plastics Ave., Pittsfield, Mass. 01201 [350]

High Purity GaAs epitaxial layers are available for Gunn and limited space-charge accumulation mode microwave devices. They have carrier concentrations in the 10^{14} - 10^{15} electrons/cm³ range and electron mobilities of better than 8,000 and 100,000 cm²/volt-sec at room temperature and liquid nitrogen temperature, respectively. Bell & Howell Co., 360 Sierra Madre Villa, Pasadena, Calif. 91109 [351]

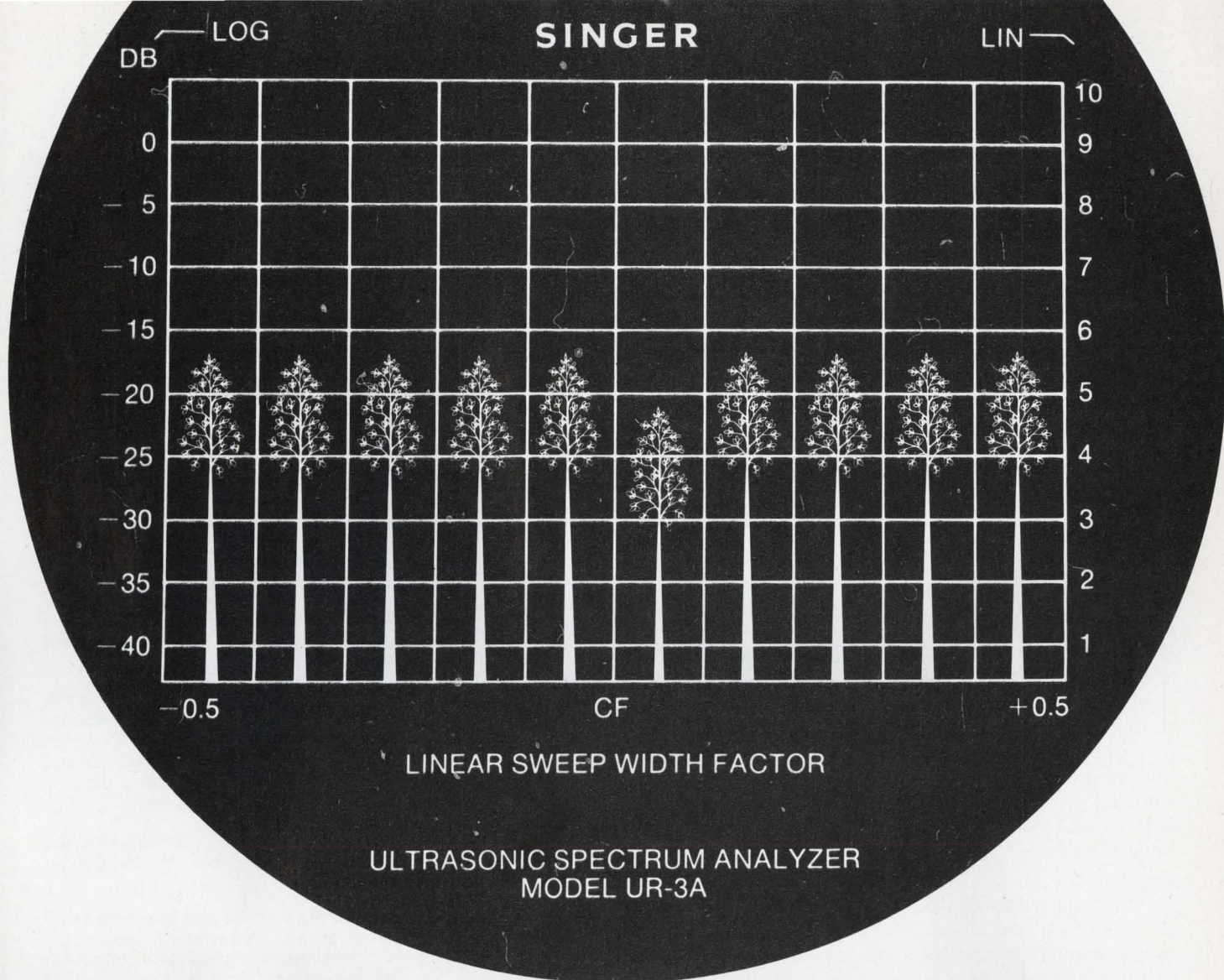

See the forest...or the tree

Drift Free Spectrum Analysis to 1.3 MHz. . . .

"Quick look" overall broad band views and highly resolved narrow scans are quickly set up with the New Model UR-3A. An indispensable tool for the rapid measurement of telephone carrier channel equalization; measuring slope, bulge, and twist. Noise distortion and other troubles are easily seen and measured.

Creative design features . . .

- Less than 100 Hz drift in 24 hours, after a short warm-up period.
- Maximum 1.3 MHz sweep width for overall quick look analysis.
- Narrow scans as low as 500 Hz.
- Accurate digital center frequency and sweep width readout.
- Crystal markers at 25 kHz intervals . . . pinpoint the signal of interest in seconds.

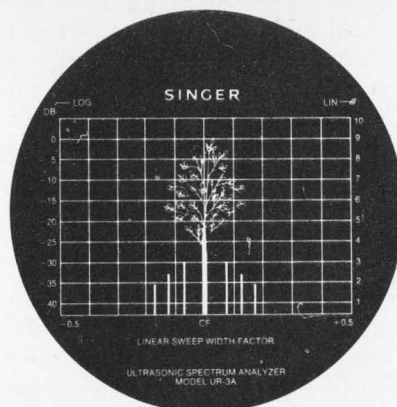

- 60dB dynamic range and 30 microvolt sensitivity combine for the measurement of low level spurious and distortion products.
- 120dB signal attenuator in 0.5dB steps.

For complete details and application assistance, contact your nearest representative or write directly to:

The Singer Company,
Instrumentation Division,
915 Pembroke Street,
Bridgeport, Conn. 06608
In Europe contact:
Singer Sewing Machine Company,
Instrumentation Division, P.O. Box 301,
8034 Zurich, Switzerland,
Telephone: (051) 472510



SINGER
INSTRUMENTATION

Technical Abstracts

Super-squeeze-in

A super-integrated four-decade counter with buffer memory and d/a output converters

B. Gilbert
Tektronix Inc., Beaverton, Ore.

Designers of planar integrated circuits have a tendency to regard their product as a sort of discrete-component assembly glued together with a kind of silicon cement. But these components are actually distributed throughout small areas in the structure. When we recognize this fact we can combine many more devices into common epitaxial regions than has been possible heretofore, thereby eliminating many isolation walls and the space they require.

In fact, with this approach, Tektronix has squeezed no less than four decade counters, three output buffers, and four decimal-to-analog conversion circuits onto one chip only 60 mils square. Each counter-buffer combination fits on a strip measuring 6 by 30 mils; the four together thus are 24 by 30 mils, and the rest of the chip is occupied by the converters and the pads for external connections. This is only about 5% to 10% of the area that conventional techniques would require.

The technique also has a secondary advantage: It requires few silicon-metal-silicon interconnections. As a result, the structure has few enlarged contact areas in the diffusions, which reduces the area of the circuit even further and significantly improves the device's compactness, yield, and reliability. Data travels, not through wires or metallization layers, but across lateral pnp bases or buried layers.

Of course, there are tradeoffs to this approach. There is a lot of parasitic crosstalk in the circuit, whose behavior must be predictable in spite of it. Also, in a microphotograph of the circuit or of a portion of it, individual components are difficult to distinguish.

The decimal-to-analog converter included in the structure transforms the decimal output into an analog current that varies from one extreme to the other in 10 steps

corresponding to the 10 stages. This current is required in a system that will use this counter.

The circuit operates smoothly at clock rates as high as 2 megahertz.

Presented at International Solid State Circuits Conference, Philadelphia, Feb. 18-20.

Soft touch

Integrated-circuit diagnostics using electron beam probes
James F. Norton and Howard L. Lester
General Electric Research and Development Center
Schenectady, N. Y.

A new electron-beam probe instrument provides dynamic signal testing capability for linear and digital integrated circuits. The system checks artwork, fabrication, and inherent design through a primary electron beam, that scans the IC, and a collected and focused secondary beam, that acts as the instrument's signal. Time resolution of 20 nanoseconds can be obtained without charging the probed surface and without injecting carriers in the IC devices.

This electron beam probing method avoids some of the shortcomings of previous methods.

The electron gun features a low divergent angle and has a useful beam current of 1 microampere focused to a 6-micron-diameter spot. Secondary electrons—a function of the signal within the IC—rebound from the IC's surface and are collected by a pickup system biased to attract these electrons to a solid-state detector. Current amplification in the detector is virtually noise free.

The electron-beam scanning system includes logic functions and scope displays. In the logic, a master clock operating at 1.4 megahertz controls the sequence of operations. Horizontal and vertical sweeps can be frozen at any point in their scan so that the beam won't move while the beam is testing a particular spot on the chip.

With this instrument, it's possible, for example, to pinpoint the location at which pulses are stopped, for whatever reason, on their way through a digital device.

Presented at NEC, Chicago, Dec. 8-10, 1969.

New Books

Reactivity of Solids: Proceedings of the Sixth International Symposium on the Reactivity of Solids, ed. J.W. Mitchell, R.C. DeVries, R.W. Roberts, and P. Cannon, 852 pp., \$24.95

This book is a collection of papers presented in August 1968. Papers are on crystal structures, surfaces, defects, and diffusion processes in chemical reactions involving solids; nucleation and growth of new phases in the solid state; thermal decomposition reactions of inorganic compounds; and reactions of elements, alloys, and compounds with gases and solutions. Also included are papers on production of crystalline solids from reactants in the gaseous phase, and chemical reactions between crystalline solids among others.

Microwaves, A.J. Baden Fuller, Pergamon Press, 289 pp., \$7.50 hard cover, \$5.50 paper

This book is divided into two main parts—a theoretical development of electromagnetic propagation of guided waves starting from Maxwell's equations and the material properties, and a description of microwave components.

Notes on Digital Communication, George L. Turin, Van Nostrand-Reinhold, \$2.75

Written for the first-year graduate level, these notes are primarily concerned with optimization of modern units of a digital communication system. Text concentrates on underlying theory, rather than applications.

Twenty Questions on Conference Leadership, Ernest Nathan, Addison-Wesley, 126 pp., \$4.95

Examines the most frequently asked questions on how to conduct an effective conference. Provides guidelines for beginning and summarizing the conference and gives practical, time-proven solutions for some of the most difficult problems faced by conference leaders.

The Radio Amateur's Handbook, American Radio Relay League, 710 pp., \$4.50

Standard textbook and reference for both beginners and advanced amateurs. Contains a considerable amount of new material on state-of-the-art techniques and equipment.

Engineers' Relay Handbook, National Association of Relay Manufacturers, Hayden Book Co., 355 pp., \$13.95

Thorough coverage of relays, inspection testing, life testing, and military specification requirements. Features include discussion of magnet wires, and descriptions of hybrid combinations of relays and solid state devices. Diagrams, charts, and tables are included.



EMPLOYMENT OPPORTUNITIES



We have been placing B.S., M.S. and Ph.D.

ELECTRONIC ENGINEERS

in fee paid positions throughout the U.S. since 1959. Send resume today or request confidential application. We are graduate engineers, working full time . . . for you.

ATOMIC PERSONNEL, INC.

Suite L, 1518 Walnut St., Phila., Pa. 19102
AN EMPLOYMENT AGENCY FOR ALL TECHNICAL FIELDS

CIRCLE 966 ON READER SERVICE CARD

ADDRESS BOX NO. REPLIES TO: Box No. Classified Adv. Dept. of this publication. Send to office nearest you.

NEW YORK, N. Y. 10036: P. O. Box 12
CHICAGO, Ill. 60611: 645 N. Michigan Ave.
SAN FRANCISCO, Cal. 94111: 255 California St.

POSITIONS VACANT

Wanted—Electrical or electronics engineer with five or more years experience needed to teach in the area of electronics technology. Applicant must have B.S. degree (M.S. preferred). Salary commensurate with qualifications. Excellent future. Send resume to: Dr. A. A. Paloumpis, Dean of Instruction, Illinois Central College, P.O. Box 2400, East Peoria, Illinois 61611.

RESUMES

The Resume Game: An Insider's Guide. How to write & use yours successfully. Samples. \$4. Plymouth Pubs, Box 318A, Plymouth Mtg., Pa. 19462.

CLASSIFIED ADVERTISING



SEARCHLIGHT SECTION

BUSINESS OPPORTUNITIES
USED OR SURPLUS EQUIPMENT

LARGEST INVENTORY OF U.S. MILITARY RADARS IN THE WORLD

TRACKING—SEARCH—AIRBORNE
WRITE FOR FREE 16-PG. CATALOG

RADIO RESEARCH INSTRUMENT CO.

45 W. 45th ST., N.Y., N.Y. 10036
212-586-4691

CIRCLE 967 ON READER SERVICE CARD

Remember . . .

MAIL MOVES

THE COUNTRY

but . . .

ZIP CODE MOVES

THE MAIL

New Literature

Polyimide resins. Monsanto Co., 800 N. Lindbergh Blvd., St. Louis, Mo. 63166, has available technical bulletins and data sheets describing the properties and performance characteristics of seven Skybond high heat-resistant polyimide resins.

Circle 446 on reader service card.

Elapsed-time indicators. General Time Corp., 1200 Hicks Rd., Rolling Meadows, Ill. 60008, has issued a series of technical data bulletins on its high-reliability, miniaturized elapsed-time indicators developed for application to aerospace, avionics, and ground support equipment. [447]

Drafting aids. Chartpak Rotex, 2620 S. Susan St., Santa Ana, Calif. 92704. An informative 40-page catalog describes an extensive line of pressure-sensitive electronic circuitry drafting aids. [448]

Temperature controllers. Fenwal Inc., 400 Main St., Ashland, Mass. 01721, has available technical literature on the series 525 miniaturized, solid state, nonindicating temperature controllers. [449]

IC core memory. Honeywell Computer Control Division, Old Connecticut Path, Framingham, Mass. 01701, offers a brochure and technical bulletin on the ICM-160 integrated circuit core memory. [450]

TTL IC logic. Sprague Electric Co., 35 Marshall St., North Adams, Mass. 01247, has released a comprehensive 88-page brochure on series 54H/74H high-speed TTL integrated circuit logic. [451]

Rfi filters. Components Corp., 2857 N. Halsted St., Chicago 60657. A design engineering catalog describes a complete line of new, low-cost rfi equipment filters. [452]

Thermocouples. High Temperature Instruments Corp., Union Hill Building, West Conshohocken, Pa. 19428, has available a 20-page brochure on the basic theory of millisecond response thermocouples. [453]

Computer handbook. Varian Data Machines, 2722 Michelson Dr., Irvine, Calif. 92664. The 520/i, a versatile minicomputer priced at \$7,500, is the subject of a 408-page manual. [454]

Spectrum analyzer. Barry Research, 934 E. Meadow Dr., Palo Alto, Calif. 94303. A two-page data sheet covers the model 2002 spectrum analyzer, which is intended for use in systems where real-time analysis of low-frequency signals is necessary. [455]

Tantalum capacitors. Components Inc., Biddeford, Me. 04005, has prepared an

TIMELY.

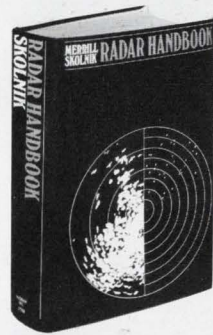

RADAR HANDBOOK

MERRILL I. SKOLNIK

Superintendent, Radar Division,
Naval Research Laboratory
1536 pages, 1140 illustrations, \$39.50

The RADAR HANDBOOK provides in a single volume a comprehensive survey of the major aspects of radar. Broad in its coverage, with each chapter written by an expert describing his particular specialty, the book is intended for all those who are involved with the design, development, or procurement of radar systems or with research in radar technology.

The components and subsystems of which a radar is composed are described in chapters on transmitters, receivers, displays, RF devices, RF devices, solid-state radar, antennas, and radomes. A major part of the handbook are the chapters on radar techniques such as MTI, AMTI, pulse doppler, CW, FM-CW, tracking height finding, pulse compression, digital signal processing, bistatic radar and synthetic aperture radar.

AT YOUR BOOKSTORE
OR DIRECT FROM PUBLISHER

McGRAW-HILL BOOK COMPANY
330 W. 42nd St., N.Y., N.Y. 10036

Send following book for 10 days' examination. I will either remit or return within 10 days. (Remit in full with coupon, plus local tax, and McGraw-Hill pays all delivery charges.)

(579086) RADAR HANDBOOK

Name _____

Address _____

City _____

State _____

Zip _____

23-E-3307

NEW FEATURES! Lock in



automatic
retrieval of
signals with

Ithaco's 353 Phase-Lock amplifier

- self tuning
- wide frequency range
- sensitivity to 1 μ v full scale
- narrowest noise bandwidth
- versatile preamps

NEW OPTIONS:

- true log output with no manual gain change for 10,000 to 1 input signal range (permits automatic ratio

- and phase measurements.)
- accuracy $\pm 2\%$ of reading.

For more information contact:

607 272-7640



735 WEST CLINTON STREET, ITHACA, N.Y. 14850

Circle 163 on reader service card

Micro-Miniature Reed Relays



Coto's
New
Micro-Miniature
Series UM

- Extremely small size: .400" x .300" OD
- Occupies less than 0.03 cu. in.
- Ultra-high speed 100 Microseconds operate time excluding bounce
- Stock voltages 3, 6, 12 and 24 volts
- Available with either leads or pins with 0.2" spacing

Special voltages, resistances, electrostatic and/or magnetic shields available. Write for new Data Sheet MR-9.1



COTO-COIL COMPANY, INC.
61 Pavilion Avenue, Providence, R. I. 02905
Tel: (401) 941-3355

THIS SPACE CONTRIBUTED BY THE PUBLISHER



Photo: O'Neill Miss Raquel Welch

Learn cancer's warning signals. You'll be in good company.

1. Unusual bleeding or discharge.
2. A lump or thickening in the breast or elsewhere.
3. A sore that does not heal.
4. Change in bowel or bladder habits.
5. Hoarseness or cough.
6. Indigestion or difficulty in swallowing.
7. Change in size or color of a wart or mole.

If a signal lasts longer than two weeks, see your doctor without delay.

And be sure to have a health checkup once a year, no matter how well you may feel.

Fight Cancer with a checkup and a check

New Literature

eight-page booklet giving performance characteristics of tantalum capacitors. [456]

Digital computer. Raytheon Computer, 2700 S. Fairview St., Santa Ana, Calif. 92704. A six-page brochure written for system designers, explains the general operating features of the 704 general-purpose digital computer. [457]

Cermet components. CTS of Berne Inc., Berne, Ind. 46711. An eight-page brochure describes the company's capability in cermet technology based on over 10 years experience in producing cermet potentiometers, trimmers, and resistor modules. [458]

R-f assemblies. Polyflon Corp., 35 River St., New Rochelle, N.Y. 10800, offers a bulletin describing the design and fabrication of narrow and broadband r-f assemblies including cavities, flat lines, and lumped constants. [459]

Plane and stack tester. Dataram Corp., Route 206, Princeton, N.J. 08540. An illustrated bulletin contains information on the model 101 automatic memory-plane and stack tester. [460]

Pushbutton switch. Micro Switch, 11 W. Spring St., Freeport, Ill. 61032. Product sheet 1SN describes a solid state switch developed for keyboards. [461]

Complete-isolation amplifier. Develco Inc., 2433 Leghorn St., Mountain View, Calif. 94040. A six-page short-form catalog describes the Iso-amp complete-isolation signal amplifier. [462]

Lever-lock switches. C&K Components Inc., 103 Morse St., Watertown, Mass. 02172, has available a data sheet discussing subminiature lever-lock switches. [463]

Solid state modules. Solid State Electronics Corp., 15321 Rayen St., Sepulveda, Calif. 91343, has issued a 32-page short-form catalog on its line of solid state modules for military and industrial applications. [464]

Time-delay relays. Midtex/Aemco, 10 State St., Mankato, Minn. 56001. Engineering bulletin 615/616 covers a line of solid state time-delay relays. [471]

Photoresists. Norland Products Inc., P.O. Box 145, North Brunswick, N.J. 08902, offers a brochure describing water-soluble photoresists for photochemical machining electronic components and other critical-tolerance parts. [472]

Integrated circuits. Fairchild Semiconductor, Box 1058, Mountain View, Calif. 94040, has published a 32-page brochure describing integrated circuits in the 5400 and 7400 TTL series. [473]

LSI

The Changing Interface

Medium and large scale integration are slated to have major impact on the electronics industry. The effects are already being felt — not only on systems and component design — but on fundamental, traditional relationships between equipment builders and component suppliers.

Important trends that will affect your profession, your job, your company, are explored in LSI: THE CHANGING INTERFACE, a 100-page illustrated volume published by McGraw-Hill's Electronics/Management Center.

In THE CHANGING INTERFACE, leading design engineers and managers, the men responsible for guiding their companies through the next generation of electronics, discuss the problems that LSI/MSI are stirring up — and offer their solutions.

Here are some of the vital topics covered.

- Implications of LSI on the Electronics Market
- The Rationale for an In-House IC Capability
- The Component Maker's Responsibility vs. the System Builder's Responsibility
- Masks and Computer-Aided Design at the Interface
- The Testing Interface
- How IBM and Bell Laboratories Deal with the Interface Problem
- Controversies and Future Trends in LSI

Copies of LSI: THE CHANGING INTERFACE are available now at \$10 per copy. Fill in and return the coupon below. If you send a check now, we'll pay the cost of postage and handling.

Electronics/Management Center
330 West 42nd St.
New York, N.Y. 10036

Attn. Mr. Wayne Cowart

Please send _____ copies of LSI: THE CHANGING INTERFACE at \$10 per copy.

Name _____ Title _____

Company _____

Company Address _____

City _____ State _____

- Check enclosed for _____ Bill me
 Bill Company, P.O. Number _____

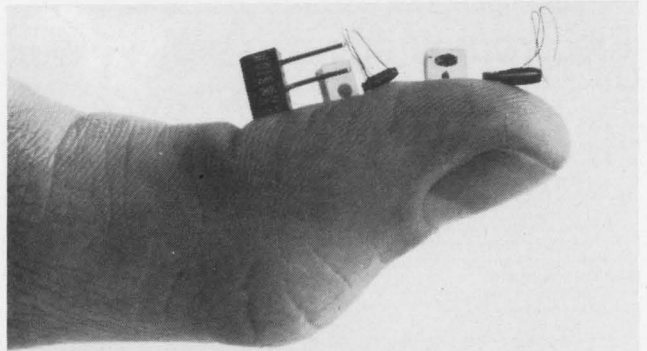

new micro-miniature inductors break price and space barrier

For the first time, ultra-miniaturization hasn't resulted in price escalation. In fact, the new Cambion micro-miniature inductors are competitive with much larger conventional units in terms of price. In terms of size, there's no comparison.

Designed to keep pace with the shrinking area of modern electronic (thick and thin film) circuitry, Cambion's new micro size inductors span the range of values from .06 to 10,000 uH, have excellent Q readings for such tiny packages, and come either fixed or variable.

And, best of all, they're available as standards (as are all Cambion inductors) — you can get more of the same, with known operating characteristics, fast (they're stock items). We've devoted one whole issue of our Product News to describing them. We'll send you a copy, if you'll send us your name. Cambridge Thermionic Corporation, 445 Concord Avenue, Cambridge, Mass. 02138.

Standardize on

CAMBION[®]

The Guaranteed Electronic Components

Circle 164 on reader service card



YOU'RE WHISTLING IN THE DARK...

if you think that heart disease and stroke
hit only the other fellow's family.

**GIVE ... so more will live
HEART FUND**



Contributed by the Publisher

Advertising Sales Staff

Dan McMillan III [212] 971-3468
Associate Publisher

Walls Clarke [212] 971-2187
Advertising Sales Service Manager

Tomlinson Howland [212] 971-6792
Promotion Manager

Warren H. Gardner [212] 971-3139
Eastern Advertising Sales Manager

Atlanta: Ga. 30309: Charlton H. Calhoun, III
1375 Peachtree St., N.E.
[404] 892-2868

Boston, Mass. 02116: William S. Hodgkinson
McGraw-Hill Building, Copley Square
[617] CO 2-1160

Cleveland, Ohio 44113: William J. Boyle, 55
Public Square, [216] SU 1-7000

New York, N.Y. 10036
500 Fifth Avenue
James R. Pierce [212] 971-3615
John A. Garland [212] 971-3617
Michael J. Stoller [212] 971-3616

Philadelphia, Pa. 19103:
Jeffrey M. Preston
6 Penn Center Plaza,
[215] LO 8-6161

Pittsburgh, Pa. 15222: Jeffrey M. Preston,
4 Gateway Center, [412] 391-1314

Rochester, N.Y. 14534: William J. Boyle,
9 Greylock Ridge, Pittsford, N.Y.
[716] 586-5040

Chicago, Ill. 60611: Ralph Hanning,
Kenneth E. Nicklas, 645 North Michigan
Avenue, [312] MO 4-5800

Dallas, Texas 75201: Richard P. Poole, 1800
Republic National Bank Tower,
[214] RI 7-9721

Houston, Texas 7702: Richard P. Poole
2270 Humble Bldg. [713] CA 4-8381

Detroit, Michigan 48226: Ralph Hanning,
856 Penobscot Building
[313] 962-1793

Minneapolis, Minn. 55402: Kenneth E. Nicklas,
1104 Northstar Center [612] 332-7425

St. Louis, Mo. 63105: Kenneth E. Nicklas,
The Clayton Tower, 7751 Carondelet Ave.
[314] PA 5-7285

James T. Hauptli [415] DO 2-4600
Western Advertising Sales Manager

Denver, Colo. 80202: David M. Watson,
Richard W. Carpenter
Tower Bldg., 1700 Broadway
[303] 266-3863

Los Angeles, Calif. 90017: Ian C. Hill,
Bradley K. Jones, 1125 W. 6th St.,
[213] HU 2-5450

Portland, Ore. 97204: Don Farris,
James T. Hauptli, 218 Mohawk Building,
222 S.W. Morrison Street,
Phone [503] 223-5118

San Francisco, Calif. 94111: Don Farris,
James T. Hauptli, 255 California Street,
[415] DO 2-4600

Pierre Braude Tel: 727 73 01: Paris
International Director

Paris: Denis Jacob
17 Rue-Georges Bizet, 75 Paris 16, France
Tel 727 33 42, 727 33 60

United Kingdom and Scandinavia

London: Oliver Ball, Tel: Hyde Park 1451
34 Dover Street, London W1

Milan: Robert Saldel, Roberto Laurer Jr.
1 via Baracchini Phone 86-90-656

Brussels: Denis Jacob
27 Rue Ducale Tel: 136503

Frankfurt/Main: Hans Haller
Elsa-Brandstroem Str. 2
Phone 72 01 81

Geneva: Pierre Braude
1 rue du Temple Phone: 31 95 60

Tokyo: Noboru Matsumoto, McGraw-Hill
Publications Overseas Corporation,
Kasumigaseki Building 2-5, 3-chome,
Kasumigaseki, Chiyoda-Ku, Tokyo, Japan
[581] 9811

Osaka: Akihiko Kamesaka, McGraw-Hill
Publications Overseas Corporation, Kondo
Bldg., 163, Umegae-cho Kita-ku [362] 8771

Australasia: Warren E. Ball, IPO Box 5106,
Tokyo, Japan

Business Department

Stephen R. Weiss, Manager
[212] 971-2044

Thomas M. Egan,
Production Manager [212] 971-3140

Maury D'Gongora,
Assistant Production Manager [212] 971-2045

Dorothy Carmesin, Contracts and Billings
[212] 971-2908

Frances Vallone, Reader Service Manager
[212] 971-2865

The CHAMP'S family

Whether you're in bioscience, medicine, electronics, assembly, inspection, research/development, quality control/assurance, there's a member of The Champ's family of Bausch & Lomb StereoZoom Microscopes exactly suited to your specific needs.

The Champ's new catalog will give you all the facts about the first family of stereomicroscopes... every one built to the exacting degree of high quality that is Bausch & Lomb.

Write for catalog 31-15 and The Champ's free demonstration plan.

StereoZoom. Reg. T.M. Bausch & Lomb



BAUSCH & LOMB 
SCIENTIFIC INSTRUMENT DIVISION

99727 Bausch Street, Rochester, N.Y. 14602

Oak Versatility



Stepping Switches for almost any remote switching job

Remote control—rugged and reliable—is the sole function of any Oak Stepping Switch. Switching or other operations (master-slave circuits, sequential timing circuits, counting applications) at relatively inaccessible or distant locations are no longer a problem. There's a standard Oak Solenoid or Stepping Switch for almost any circuit design—or we'll develop a special one.

Oak Stepping Switch units are precisely engineered, combining the quality and capabilities of Oak rotary switches with the remote control utility of Oak Solenoids. This team readily performs multiple switching functions in limited space under severe operating and environmental conditions.

For full details on the complete line of versatile Oak solenoids and stepping switches, write today for Bulletin SP-288.



OAK MANUFACTURING CO.
A Division of OAK ELECTRO/NETICS CORP.
Crystal Lake, Illinois 60014
Phone: 815-459-5000 TWX: 910-634-3353

FOR EXCELLENCE IN TERMINATION HARDWARE SPECIFY GRAYHILL



Test Clips

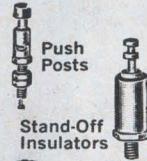

Push Posts

Stand-Off Insulators



Binding Posts



Sockets



Plastic Molded Parts



Test Clips

Adjustable tension, threaded studs or plug in bases, various sizes.

Push Posts

Plunger action lets you connect and disconnect quickly and easily, assures positive contact.

Binding Posts

Screw type or spring loaded, banana plug or stud mounting, single or multiple units, with various colors for circuit identification.

Stand-Off Insulators

High dielectric strength, low loss insulation, low moisture absorption, various mounting styles.

Sockets

Lamp or transistor, various colors, various mountings including printed circuit.

Custom Molded Parts

Tight tolerances provide you with "assembly ready" units. Thermosetting plastics to meet most specifications.

For your Grayhill Engineering Catalog offering complete technical data—contact



523 Hillgrove Avenue
LaGrange, Illinois 60525
Area Code 312, Phone 354-1040

... the Difference Between Excellent and Adequate

Circle 165 on reader service card

Motorola crystal controlled clock oscillators



As small as 1.5 cubic inch Ages less than 1×10^{-6} per year

Where rugged construction, small size and instant warm-up are desired, Motorola Clock Oscillators fill the bill for a wide variety of applications.

Wide Frequency Range. 400 KHz to 40 MHz. Extended ranges on special order.

Small Size. As small as 1.5 cubic inch.

Stability. Ranges from ± 5 ppm to 100 ppm from 0°C to + 55°C. Extended ranges on special order.

Low Power. For voltage of 5v to 15v, 30 mw to 100 mw typical. Variations in input voltage, frequency, output level and wave shape can be made to special order. Tell us your needs!

For complete information, send for a free copy of Bulletin TIC-3609 today. Write Component Products, Dept. 39-F, Motorola Communications & Electronics, Inc., 4501 W. Augusta Blvd., Chicago, Illinois 60651; or call (312) 772-6500.



Power hungry?

Dale makes an
industrial wirewound
for every appetite...

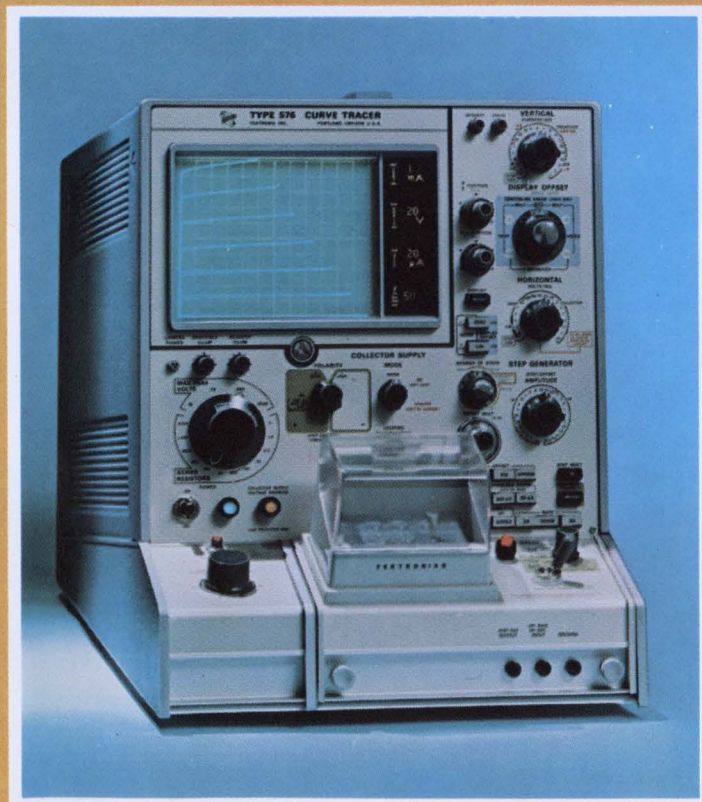

Tektronix, for example...

Dale offers you a wider choice in meeting industrial power resistor requirements: Silicone-coated HL types where maintenance of tolerance and low TC are important. Vitreous-enamel coated VL types where rugged environments are encountered. Tektronix uses the space-saving flat HL style in the collector supply of its versatile Type 576 Semiconductor Curve Tracer. For precision instruments like this, tolerances down to 1% are available, plus taps, sliders, lugs, leads—even special sizes to 1,000 watts. You name it—we're waiting.

PHONE 402-564-3131 for information
or write for Catalog A



DALE ELECTRONICS, INC.

1300 28th Ave., Columbus, Nebraska 68601
In Canada: Dale Electronics Canada, Ltd.

A subsidiary of The Lionel Corporation



Circle 901 on reader service card

Where's the excitement in digital IC's today?

RCA's expanding COS/MOS line.

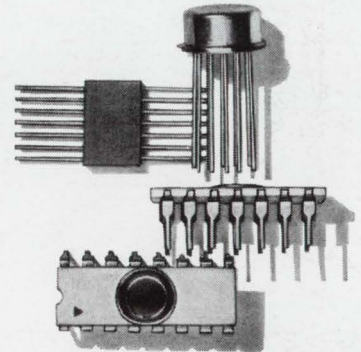

Circuit designers and component engineers, in increasing number, are taking advantage of the unique performance features of RCA COS/MOS IC's. They are attracted by the immediate availability of production quantities and the economics of these devices; and RCA's continued leadership in expanding the number of circuit types in this exciting line. Today, there are COS/MOS IC's to satisfy most of your commercial, industrial, aerospace and military logic-system design requirements.

Look at these COS/MOS IC advantages:

- Extremely low quiescent power dissipation gates — $P_T = 10$ nW/pkg (typ) @ $V_{DD} = 10$ V
MSI circuits — $P_T = 5$ μ W (typ) @ $V_{DD} = 10$ V
- Speed gates — propagation delay (t_{pd}) = 50 ns (typ) @ $V_{DD} = 10$ V, $C_L = 15$ pF
MSI circuits — clock pulse frequency (f_{cl}) = 2.5 MHz (typ) @ $V_{DD} = 10$ V
- Excellent dc and dynamic noise immunity — 4.5 V (typ) @ $V_{DD} = 10$ V
- High dc fanout (e.g. > 50)
- Simple circuit and subsystem design
- Compatible gate level and MSI functions
- Operation from one unregulated power supply — 6 to 15 V
- Full military operating-temperature range — -55°C to $+125^\circ\text{C}$
- Stable performance over wide ranges of supply voltage and temperature

They all add up to a big plus for circuit engineers: lower system design and production costs.

For further information on COS/MOS integrated circuits, see your local RCA Representative or RCA Distributor. Ask for the following COS/MOS application information: "Counters and Registers", ST 4166; "Noise Immunity", ICAN 6176; "Astable and Monostable Oscillator Designs", ICAN 6267; "COS/MOS Reliability", RIC 101. Or write: RCA Electronic Components, Commercial Engineering, Section ICN 3-2 / CD34, Harrison, N. J. 07029. In Europe: RCA International Marketing S.A., 2-4 rue du Lièvre, 1227 Geneva, Switzerland.

Flat Pack Type No.	DIC Type No.	Description	Flat Pack Price-Each (1000 or more quantities)	DIC Price-Each
Gates				
CD4000	CD4000D	Dual 3-input NOR plus inverter	\$ 5.00	\$ 4.00
CD4001	CD4001D	Quad 2-input NOR	5.75	4.75
CD4002	CD4002D	Dual 4-input NOR	5.50	4.50
CD4007	CD4007D	Dual complementary pair plus inverter	4.00	3.00
CD4011	CD4011D	Quad 2-input NAND	5.75	4.75
CD4012	CD4012D	Dual 4-input NAND	5.50	4.50
Flip-Flops				
CD4013	CD4013D	Dual-D with set/reset capability	9.00	8.00
Hex Buffers/Logic-Level Converters				
—	CD4009D	Inverting	—	7.00
—	CD4010D	Non-inverting	—	7.00
Memories — MSI				
CD4005	CD4005D	16-bit NDRO	11.00	10.00
Static-Shift Registers — MSI				
CD4006	CD4006D	18-stage	18.25	17.25
—	CD4014D	8-stage synchronous parallel-input/serial-output	—	13.60
—	CD4015D	Dual 4-stage serial-input/parallel-output	—	13.60
Counters — MSI				
CD4004	—	7-stage ripple counter/freq. divider	11.00	—
—	*CD4004T		—	10.00
Adders — MSI				
—	CD4008D	4-bit full adder with parallel carry out	—	16.00

*TO-5 package
(COS/MOS IC's listed in bold-face type are recent additions to the line.)

RCA Integrated Circuits