

MARCH 6, 1975

A SPECIAL REPORT ON ISSCC/100

Preview from Paris: Uncertainty looms at Components Show/58

Microprocessor packs more functions on four small chips/87

Physics Department
Resources Center
University of Wisconsin-Stevens Point
Stevens Point, Wis. 54481

FOUR DOLLARS A MCGRAW-HILL PUBLICATION

Electronics®

MAR 10 1975



Impulse bonding cuts multilayer board cost

1420-11999-89HKS/DECS
WI UNIVERSITY
LRC LIBRY PERIODICALS
STEVENS POINT WI
54481

315
L30J



**Datatron's Hustler 45 10MHz
clock rate tester makes precise propagation
delay measurements on MOS, CMOS
and bipolar devices**



300NS

Long rise time measurements — the kind necessary with CMOS — are tough to make. Our Hustler 45 10MHz clock rate test system makes them precisely — with one nanosecond resolution.

We do this with a unique iterating strobe comparator rather than a discriminator system.

Hustler 45 can measure access time and propagation delay on all pins simultaneously. With 96 pin capacity. We have a separate force/monitor electronics card (PEC) for each pin. Drivers and comparators are located just inches from the device under test. Each pin can act as an input, an output, or be disconnected. IC's are tested as they actually operate in the real world.

**Low impedance drivers for
MOS, CMOS and bipolar**

Our exclusive closed loop driver

design gives the lowest impedance in the industry; less than 0.3 ohm. You don't have to calculate drive voltages and build in error compensation. Hustler 45 is the test system designed for both worlds — MOS and bipolar.

No compromise RAM testing

A computer programmable pattern generator makes no compromise

RAM testing easy. Generation of patterns (supplied by Datatron or customer developed) is completely under operator control.

LSI flexibility

Hustler 45 is flexible too. Behind each pin is a RAM configurable to 4096 bits. Which means you can perform high speed functional and dynamic tests on complex LSI arrays.

Parametric testing too

Our stand-alone Hustler 45 provides sequential parametric testing. Our Hustler 50 can perform parallel parametric tests on devices up to 256 pins! Probably the most versatile test system on the market.

In a nutshell

Hustler 45 offers unmatched speed, versatility, and programming ease at a surprisingly low price. So talk to a Datatron sales engineer before you decide on any high speed tester. Send for our free brochure.



datatron, inc.

TEST SYSTEMS DIVISION

1562 Reynolds Ave., Santa Ana, California 92705 (714) 540-9330 • TWX 910-595-1589
Mailing Address: P.O. Box 11427, Santa Ana, California 92711

Circle 900 on reader service card

The counter system that stays on top of your needs and under your budget.

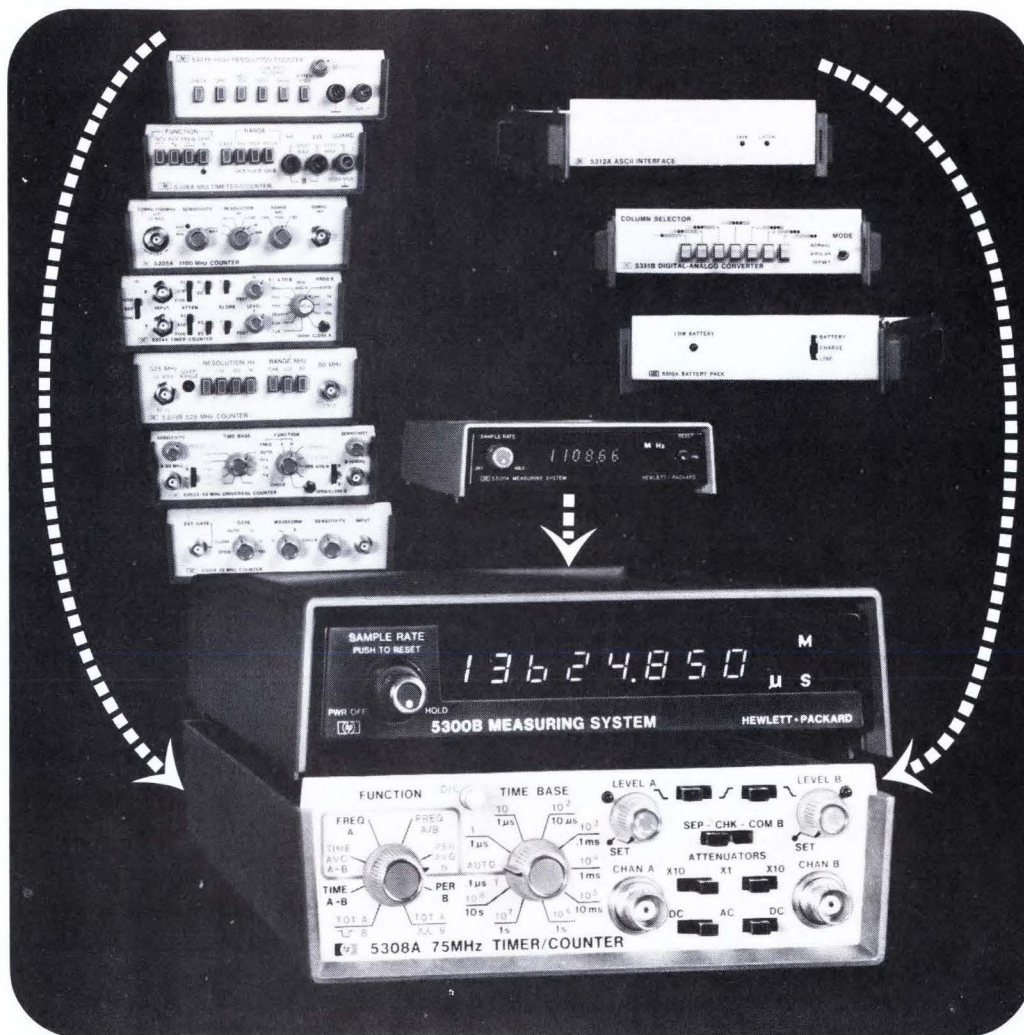

The heart of HP's versatile 5300 Measurement System is a sophisticated mainframe which contains counting circuitry and display. Snap it onto the bottom module you need and it instantly becomes one of eight feature-loaded instruments. The 5300 basic modules include:

- six and eight digit mainframes
- frequency counters to 1100 MHz
- universal counter/timers with

time interval averaging to 1nsec.

- a high resolution counter that reads 60.0000 Hz in 1 sec.
- digital multimeter/counter for ac-dc volts, ohms and frequency
- snap-between capability can be added at any time, including:
 - battery pack for portable operation
 - D to A converter for analog outputs
 - HP-IB interface for flexible data acquisition systems.

Once you have the mainframe, it's the low cost way to build a complete workshop of first-line instruments, the one system that really does stay on top of your needs — and under your budget. Prices start at \$410* for a mainframe; \$175* for a module.

Send for a free detailed brochure on HP's 5300 Series Counters.

*Domestic USA prices only.

HEWLETT *hp* PACKARD

Sales and service from 172 offices in 65 countries.
1501 Page Mill Road, Palo Alto, California 94304

DIVA: a group effort in creative problem solving

presents

“THE OPTIMIZERS”

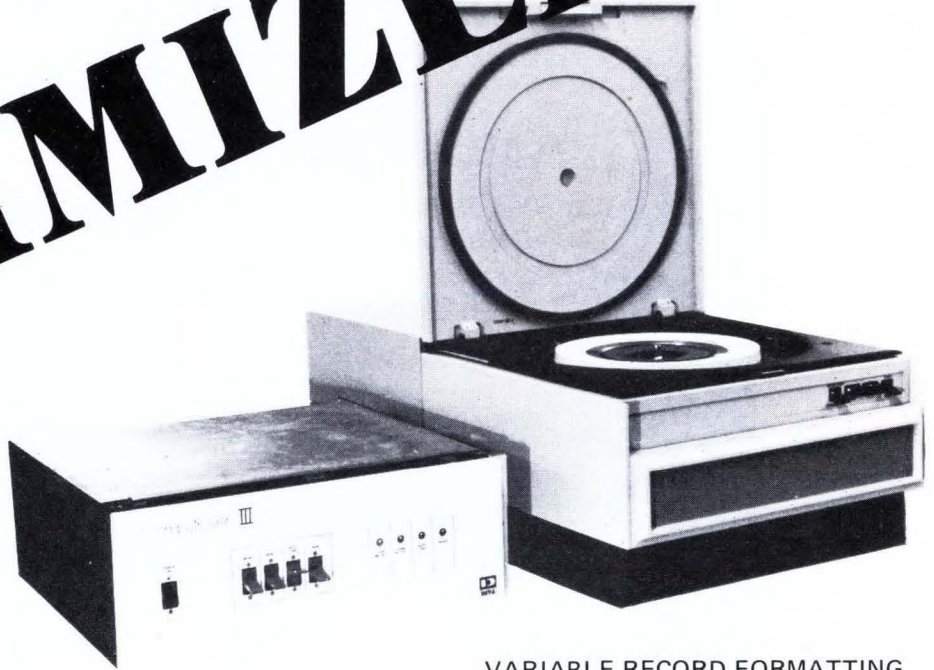

VARIABLE RECORD FORMATTING

DATA BUFFERING

VARIABLE TRANSFER RATES

INITIAL PROGRAM LOAD

OVERLAP SEEK

LOWER COST PER-BYTE RATIO

We call our Computroller and Mass Storage Systems the OPTIMIZERS because they permit your Nova, PDP-11 or Interdata to block transfer data at rates previously attainable only in the larger systems.

The OPTIMIZERS use ECC (Error Correction Code) to correct data errors “on-the-fly” without interrupting program control.

Need large storage and fast transfer rates? The OPTIMIZERS provide 54 million byte capacity (unformatted), and up to 1.2 million bytes per second transfer rate.

DMA transfers through the OPTIMIZERS’ memory buffer optimizes mass data transfer of variable length records. Couple this with ECC and head offset plus variable strobe capabilities, data integrity and accuracy remain extremely high.

The OPTIMIZERS emulate the instruction set used on the mainframe manufacturers’s system software allowing compatibility to the mini.

mini maximizer systems

DIVA, Inc. 607 Industrial Way West / Eatontown, N. J. 07724 / Phone: 201-544-9000 / TWX 710-722-6645



29 Electronics Review

SOLID STATE: Solar cell R&D getting renewed Federal effort, 29
COMMERCIAL: Applications opening for Wiegand effect, 30
Xerox facsimile writes on plain paper, 31
SIGNAL PROCESSING: LSI chip handles fast Fourier transforms, 32
BUSINESS: Texas Instruments claims first calculator patent, 32
PACKAGING & PRODUCTION: Standard art speeds printed circuits, 33
COMMERCIAL: Armored cars get digital terminal, 34
AUTOMOTIVE: Microprocessor set aims at autos, 36
INDEX OF ACTIVITY: 36
NEWS BRIEFS: 38

44 Electronics International

JAPAN: Toshiba develops green monolithic GaP display, 44
WEST GERMANY: Home-alarm kit is inexpensive, 44
AROUND THE WORLD: 45

57 Probing the News

SOLID STATE: Bipolar LSI shows its form, 57
ELECTRONICS ABROAD: Europeans also await turnaround, 60
MANAGEMENT: How TI manages in a recession, 64
MEMORIES: The users look at 4-k RAMs, 66
COMPANIES: Xerox reorganizes computer sector, 70

75 Technical Articles

PACKAGING & PRODUCTION: Impulse-bonding aids pcb changes, 75
DESIGNER'S CASEBOOK: Boosting an integrator's time constant, 82
ICs interface keyboard to microprocessor, 83
Digital command inverts signal, 85
MICROPROCESSORS: Four-chip family cuts system parts count, 87
ENGINEER'S NOTEBOOK: IC fm demodulator needs no alignment, 94
Monolithic IC simplifies dc-to-dc converter design, 95
ISSCC SPECIAL REPORT: Bipolar moves up to LSI, 100

107 New Products

IN THE SPOTLIGHT: Microwave counter reaches 18 GHz, 107
PACKAGING & PRODUCTION: Locating faults on analog boards, 108
SEMICONDUCTORS: Ion-implanted rectifiers are fast, 113
DATA HANDLING: Graphics-display generator is flexible, 117
COMPONENTS: Planar gas-discharge readout is 1 inch high, 121
INSTRUMENTS: Frequency counter tests land-mobile radios, 124

Departments

Publisher's letter, 4
Readers comment, 6
News update, 10
Editorial, 13
People, 14
Meetings, 20
Electronics newsletter, 25
Washington newsletter, 41
Washington commentary, 42
International newsletter, 47
Engineer's newsletter, 98
New literature, 129

Highlights

Cover: Impulse-bonded wiring is flexible, 75

Multilayer printed-circuit boards have to be made over from scratch if a complex system requires many circuit changes during production. It's easier and less costly to alter interconnections made by impulse-bonding wire to a special two-sided board. Cover is by photographer Mike Palmeri.

The 10,000-gate bipolar logic chip, 57

Semiconductor and computer manufacturers agree that the 16-bit bipolar microprocessor chip will become a reality in the next few years. And when that happens, the drop in cost of sophisticated process-control and data-processing equipment will trigger a sales explosion.

Microprocessor chip set reduces parts count, 87

Both simple and complex microcomputers can be built out of a modular set of four compatible chips plus a minimum of other components.

Bipolar LSI stars at ISSCC, 100

The boost being given to bipolar logic by large-scale integration is the most important news from the Philadelphia circuits conference. But linear LSI is also on the way, converters are being built by mixing different processes on the same substrate, and the 4,096-bit MOS RAM is getting faster.

And in the next issue . . .

Preview of Intercon '75 . . . facing up to microprocessors . . . some unique applications of C-MOS flip-flops.

EDITOR-IN-CHIEF: Kemp Anderson

EXECUTIVE EDITOR: Samuel Weber

MANAGING EDITORS: Lawrence Curran, *News*;
Arthur Erikson, *International*

SENIOR EDITORS: John Johnsrud,
H. Thomas Maguire, Laurence Altman,
Ray Connolly, Stephen E. Scrupski

ART DIRECTOR: Fred Sklenar

ASSOCIATE EDITORS: Howard Wolff,
Gerald M. Walker, Alfred Rosenblatt

DEPARTMENT EDITORS

Aerospace/Military: Ray Connolly
Circuit Design: D. J. Blattner

Components: Lucinda Mattera
Computers: Stephen E. Scrupski

Consumer: Gerald M. Walker
Industrial: Margaret A. Maas

Instrumentation: Andy Santoni
New Products: H. Thomas Maguire,
Michael J. Riezenman

Packaging & Production: Jerry Lyman
Solid State: Laurence Altman

COPY EDITORS: Margaret Eastman,
Everett C. Terry, Bill Dunne

ART: Charles D. Ciatto, *Associate Director*
Patricia Cybulski, *Assistant Director*

PRODUCTION EDITOR: Arthur C. Miller

EDITORIAL SECRETARIES: Janet Noto,
Julie Gorgoglione, Penny Roberts

FIELD EDITORS

Boston: Gail Farrell (Mgr.), Pamela Leven
Los Angeles: Paul Franson (Mgr.)

Judy Phelps

Midwest: Larry Armstrong (Mgr.)

New York: Ron Schneiderman (Mgr.)

San Francisco: Bernard Cole (Mgr.)

Judith Curtis

Washington: Ray Connolly (Mgr.)

Larry Marion

Frankfurt: John Gosch

London: William F. Arnold

Paris: Arthur Erikson

Tokyo: Charles Cohen

McGRAW-HILL WORLD NEWS

Director: Ralph R. Schulz

Bonn: Robert Ingersoll

Brussels: James Smith

London: Marvin Petal

Madrid: Dom Curcio

Milan: Peter Hoffmann, Andrew Heath

Moscow: Peter Gall

Paris: Michael Johnson, Richard Shepherd

Stockholm: Robert Skole

Tokyo: Mike Mealey

PUBLISHER: Dan McMillan

DIRECTOR OF MARKETING: Pierre J. Braudé

ADVERTISING SALES SERVICE MANAGER:
Wallis Clarke

BUSINESS MANAGER: Stephen R. Weiss

CIRCULATION MANAGER: Nancy L. Merritt

MARKETING SERVICES MANAGER:

Tomlinson Howland

RESEARCH MANAGER: Margery D. Sholes

Solid state technology pauses, albeit briefly, about this season for an annual, formal stocktaking. It's called the International Solid State Circuits Conference, and, with so many of the world's foremost workers in the field in attendance, it's something like closing the store once a year to check the inventory.

Indeed, says our solid state editor, Larry Altman: "No other meeting is as important in determining what's coming along in the solid state area. It's no longer just a design forum, but with heavy participation by marketing managers, distributors, and equipment manufacturers and other users, it has become an international exchange point for product information." You'll find our detailed round-up of developments that came out of this year's ISSCC on page 100, as well as an in-depth look, gleaned from ISSCC participants, at what can only be called "The New LSI" on page 57.

Actually, the whole solid state field is just about the hottest subject that we are covering. Last issue, for example, we printed a preview of the trends that would surface there and some of the individual developments that merited a closer look, as well as breaking stories on Intel's 80-nanosecond 4,096-bit RAM and speedy Schottky-clamped I²L circuits from IBM in West Germany.

And, in previous issues, we have brought you the stories of a number of important international developments that were not publicly described until their developers presented papers at ISSCC. Among these were. Motorola's C³L technique, Siemens' Polysil ECL process,

TRW's EFL approach, National Semiconductor's 16-bit micro-processor, Analog Devices' 12-bit digital-to-analog IC, and an 8-picojoule/2-gigahertz logic family and a high-speed enhancement-depletion MOS logic development from Japan's Nippon Telegraph and Telephone.

Every year, a few weeks before the Paris Components Show, *Electronics* sends its correspondents out to catch the mood of the marketplace. And this year, they report some unsettling news: the cupboards are far from bare. Thus, until equipment makers work down their excess supply of parts, it will be the pages in the component suppliers' order books that have the bare look.

Yet, all is not bleak. Some market sectors, such as telecommunications and military electronics, continue to show a lot of strength. Our story on page 60 gives you the details on what the team found in France, Italy, the United Kingdom, and West Germany, which account for nearly 85% of the estimated \$5.5 billion components market in Western Europe. Headed by Art Erikson, our Paris-based Managing Editor, International, the team included Bill Arnold in London, John Gosch in Frankfurt, and McGraw-Hill World News correspondent Andrew Heath in Milan.



March 6, 1975 Volume 48, Number 5
94,351 copies of this issue printed

Published every other Thursday by McGraw-Hill, Inc. Founder: James H. McGraw 1860-1948. Publication office 1221 Avenue of the Americas, N.Y., N.Y. 10020, second class postage paid at New York, N.Y. and additional mailing offices.

Executive, editorial, circulation and advertising addresses: *Electronics*, McGraw-Hill Building, 1221 Avenue of the Americas, New York, N.Y. 10020. Telephone (212) 997-1221. Teletype TWX N.Y. 710-581-5234. Cable address: MCGRAWHILL N.Y.

Subscriptions limited to persons with active, professional, functional responsibility in electronics technology. Publisher reserves the right to reject non-qualified requests. No subscriptions accepted without complete identification of subscriber name, title, or job function, company or organization, including product manufactured or services performed. Subscription rates: qualified subscribers in the United States and possessions, Canada, and Mexico \$12.00 one year, \$24.00 three years; all other countries \$25.00 per year, except Japan and Israel \$50.00 per year, Brazil \$40.00 per year, Australia and New Zealand \$60.00 per year, including air freight. Limited quota of subscriptions available at higher-than-basic rate for persons outside of field served, as follows: U.S. and possessions and Canada, \$25.00 one year; all other countries \$50.00. Single copies: \$4.00.

Officers of the McGraw-Hill Publications Company: John R. Emery, President; J. Elton Tuohig, Executive Vice President-Administration; Gene W. Simpson, Group Publisher-Vice President; Senior Vice Presidents: Ralph Blackburn, Circulation; Walter A. Stanbury, Editorial; John D. Hoglund, Controller; David G. Jensen, Manufacturing; Gordon L. Jones, Marketing; Jerome D. Luntz, Planning & Development.

Officers of the Corporation: Shelton Fisher, Chairman of the Board and Chief Executive Officer; Harold W. McGraw, Jr., President and Chief Operating Officer; Wallace F. Trendley, Group President; McGraw-Hill Publications Company and McGraw-Hill Information Systems Company, Robert N. Landes, Senior Vice President and Secretary; Ralph J. Webb, Treasurer.

Title registered in U.S. Patent Office; Copyright ©1975 by McGraw-Hill, Inc. All rights reserved. The contents of this publication may not be reproduced in whole or in part without the consent of copyright owner.

Subscribers: The publisher, upon written request to our New York office from any subscriber, agrees to refund that part of the subscription price applying to copies not yet mailed. Please send change of address notices or complaints to Fulfillment Manager, subscription orders to Circulation Manager, *Electronics*, at address below. Change of address notices should provide old as well as new address, including postal zip code number. If possible, attach address label from recent issue. Allow one month for change to become effective.

Postmaster: Please send form 3579 to Fulfillment Manager, *Electronics*, P.O. Box 430, Hightstown, N.J. 08520.

Waveforms you can trust from 10Hz to 10MHz.

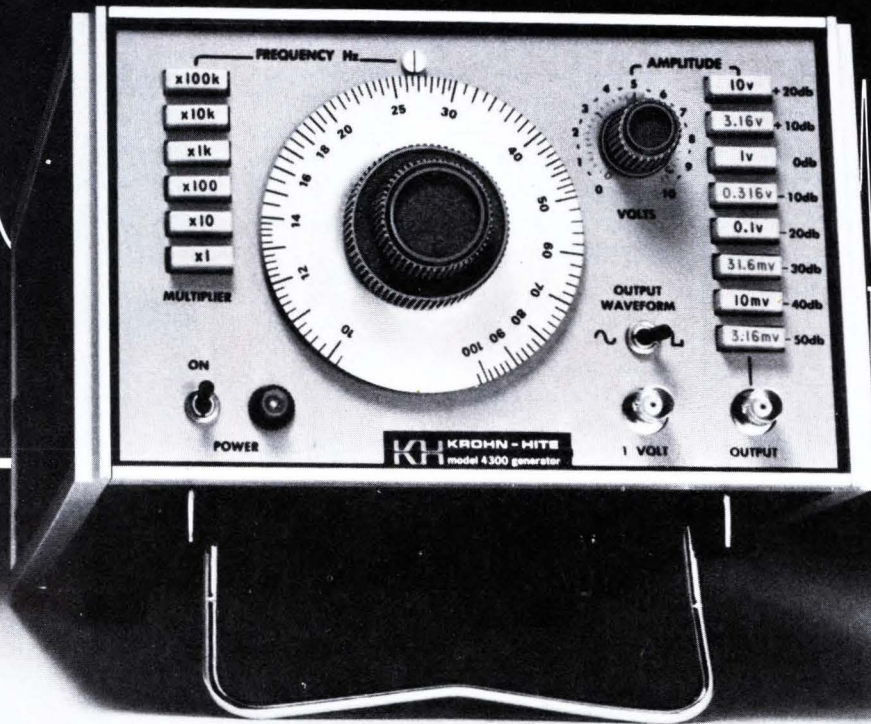

Model 4300 oscillator with 0.025 db frequency response and precision calibrated attenuator eliminates need for constant monitoring and adjustment.

You can tune it and forget it. No meter is necessary, because the output is virtually transient-free. Push button controls provide rapid frequency tuning and output control. Unlike function generators which offer sine and square waves, the Model 4300 is basically a Wien Bridge oscillator that generates true sine waves

without discontinuities or peaks. The sine wave exhibits less than 0.1 percent distortion and frequency stability is .002 percent. Price for Model 4300 is \$550. Model 4200 offers all but square wave for \$495. For fast action, call (617) 491-3211, TWX 710 320 6583, or contact your local representative listed below.

**KH KROHN-HITE
CORPORATION**
580 Massachusetts Avenue, Cambridge, Massachusetts 02139

SALES OFFICES: ALA, Huntsville (205) 534-9771; ARIZ., Scottsdale (602) 947-7841; CAL., San Jose (408) 292-3220, Inglewood (213) 674-6850; COLO., Denver (303) 750-1222; CONN., Glastonbury (203) 633-0777; FLA., Orlando (305) 894-4401; HAWAII, Honolulu (808) 941-1574; ILL., Des Plaines (312) 298-3600; IND., Indianapolis (317) 244-2456; MASS., Lexington (617) 861-8620; MICH., Detroit (313) 526-8800; MINN., Minneapolis (612) 884-4336; MO., St. Louis (314) 423-1234; N.C., Burlington (919) 227-3639; N.J., Haddonfield (609) 795-1700; N.M., Albuquerque (505) 299-7658; N.Y., E. Syracuse (315) 437-6666, Rochester (716) 328-2230, Vestal (607) 785-9947, Elmont (516) 488-2100; OHIO, Cleveland (216) 261-5440, Dayton (513) 426-5551; PA., Pittsburgh (412) 371-9449; TEX., Houston (713) 688-9971, Richardson (214) 231-2573; VA., Alexandria (703) 354-1222; WASH., Bellevue (206) 624-4035; CANADA, Montreal, Quebec (514) 636-0525, Toronto, Ontario (416) 499-5544, Stittsville, Ontario (613) 836-3990, Vancouver, British Columbia (604) 278-2009, Halifax, Nova Scotia (902) 434-3402.

Circle 5 on reader service card



Tansitor

Specialists in
Tantalum Capacitors

FOIL TYPES

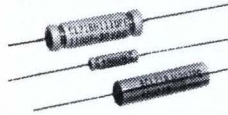

Tubular Style
CL, CLR or TE
Elastomer or
Hermetic Seals



Rectangular Packages
CL or TE 51, 52, 53, 54
Tantalum to Glass
Hermetic Seal



Special Designs
WF, TES, THS
Volumetrically efficient
Filter Capacitors



Custom Modules
Wide range of ratings
designed to meet
your requirements

WET TYPES



CL 65, CL 67, CLR65
Elastomer or
Hermetic Seals
Standard or High Cap



Rectangular Packages
CL or TE 55
Hermetic Seal
High Cap Values

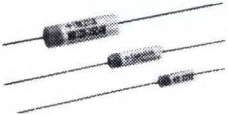

Miniature Wets
Most Volumetrically
efficient Capacitor
Low DC Leakage

MINIATURE SOLIDS



Type HA Cylindrical
Type TC Rectangular
Axial or Radial Leads
Subminiature size

For more information on TANSITOR
capacitors, call your local
Tansitor Representative, or contact:



Tansitor
ELECTRONICS
DIVISION OF AEROTRON, INC.

West Road, Bennington, Vermont 05201
Phone: (802) 442-5473 TWX: (710) 360-1782

Readers comment

On the other hand . . .

To the Editor: Although I was surprised to find a bare shoulder on the cover of your Dec. 12th issue, the amusing critical letters you published in January enticed my otherwise torporific pen hand.

I feel that you created a visually interesting cover that in no way is exploitive of women in particular. Certainly a cover depicting a moustached character in a trench coat and broad-brimmed hat, flashing the watchmakers wares on the inside of his coat, would have been a more incisive statement in terms of the present world situation (like who needs a \$1,000 watch?). Would anyone have been critical of the male exploitation implicit in such an image?

James Kosalos
Kirkland, Wash.

. . . It was a good change of pace, and you really have nothing to worry about but stirring up a few hornets.

Olivia S. Herriford
Los Angeles, Calif.

. . . I thought it consistent and appropriate to see an attractive product attractively displayed.

Brian Willes
Lakewood, Colo.

. . . It reminds me of the joke about the Old Maid who calls the police to complain about a man undressing in front of his window across the street. The police peer out the Old Maid's window and see nothing, whereupon she declares: "Well, if you pull this chair over and get on top of the chest-of-drawers, and *then* look out the window, you'll see plenty!"

Richard G. Devaney
Kingsport, Tenn.

Concern, not court action

To the Editor: The article headlined "IBM ponders court action on domsat" (Feb. 6, p. 40) could be misleading to your readers. Some of the language in the commission's opinion and order gives us serious concern, and we plan to ask the FCC for clarification on those points as soon as possible. However, I'd like to make it clear that IBM is not considering

NEW DPVM's FROM NEWPORT



BRIGHT 13MM LED DISPLAY, BCD OUTPUT, RATIO AND 2-YR WARRANTY

FOR **\$81⁰⁰***
3½ DIGIT MODEL 203

- Four full scale ranges
- Auto-Polarity \pm 1999 counts
- Voltage, Current and Ratio measurements
- Automatic Zero-Front panel F.S. adjust

(Model 2003, 4½ digit \$139*)

Whether you need 3½ or 4½ digits, Newport will deliver the most reliable and versatile Digital Panel Volt Meter (DPVM) available. With a great reduction in parts and the addition of the new ½-inch LED display, we can now increase our warranty to a full 2 years. The life expectancy of the display is greater than 11 years. Full scale ranges are 200 millivolts, 2, 20, and 200 volts. . . and BCD output comes free.

Newport now has worldwide stocking representatives providing off-the-shelf deliveries and local support. For complete data, call or write: Newport Laboratories, Inc., 630 East Young Street, Santa Ana, CA 92705.

For immediate response, CALL COLLECT
(714) 540-4686

(In Europe-Tele. Amsterdam [20] 45-20-52)

*Quantities of 100



After all the noise, the quiet logic of HiNIL and 74C CMOS keeps you on the right track.



May 10, 1869. Promontory, Utah. The rumble of wheels, the hiss of escaping steam, the shouts of the celebrating crowd filled the skies with a deafening roar when they drove the golden spike that joined the Central Pacific and Union Pacific Railroads.

But today, when you link Teledyne's high noise immunity logic, HiNIL, and our 74C CMOS together in your digital or analog/digital control designs, you'll no longer have to worry about spikes or noise. Teledyne invented HiNIL to meet the need for high noise immunity found in practically all digital systems. The success of this large and still growing family has made Teledyne a leading supplier of logic for high noise applications.

Just put HiNIL on input-output lines to block heavy noise transients and drive high current peripheral devices. And use CMOS in the middle to minimize power dissipation and increase speed and circuit density. The combination of HiNIL's guaranteed 3.5V noise margin and 74C's low power dissipation lets them quiet almost any kind of system with high noise problems.

Our two logics interface directly, too. Standard 74C drives HiNIL directly and HiNIL drives more than 50 CMOS loads. Simply connect both to an inexpensive 12 or 15V $\pm 1V$ power supply. You can even connect linear circuits to the same supply for extra savings.

HiNIL eliminates the need for drivers because it sources up to 15mA and sinks up to 65mA. That's ample capability for display tubes, LEDs, lamps and relays.

And with HiNIL you save on filter capacitors, get the extra flexibility and economies of diode-expandable inputs, and have a choice of active or passive pullup and open collector outputs. There's plenty of board-shrinking MSI in both families, too.

So write or call Teledyne today to find out about our HiNIL and 74C CMOS lines. We'll show you how easy it is to block out all the noise and stay on the right track.

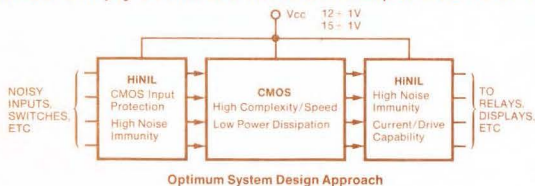

TELEDYNE SEMICONDUCTOR

1300 Terra Bella Avenue, Mountain View, California 94043 Tel: (415) 968-9241 TWX: 910-379-6494 Telex: 34-8416

ENGLAND: Heathrow House, Cranford, Hounslow, Middlesex, Tel: (44) 01-897-2503 Telex: 851-935008

FRANCE: 90, Avenue Des Champs Elysees, 75008 Paris, Tel: 2563069 Telex: 842-29642

WEST GERMANY: Albert Gebhardtstrasse 32, 7897 Tiengen, Tel: 7741-5066 Telex: 841-792-1462

JAPAN: Nihon Seimei-Akasaka Bldg. (3F), 1-19, Akasaka 8-chome, Minato-ku, Tokyo 107, Tel: 03-405-5738 TWX: 781-2424241

Additional offices in West Germany, Hong Kong and the United States. Representatives and distributors worldwide.

Sprague Delivers!

YOU DON'T HAVE TO TAKE A SUBSTITUTE.



THE CAPACITOR:

Sprague's Type 192P Pacer® ...
The Dependable Low-Cost
Miniature Polyester Film Capacitor.

THE DELIVERY CYCLE:

Large Production Quantities
4 – 8 Weeks ARO on All Popular
Ratings. Off-the-Shelf Delivery from
your Sprague Industrial Distributor.

THE CATCH:

None.
Sprague Delivers Film Capacitors.

Call your nearest Sprague district office or
sales representative for complete information.

Sprague Electric Company,
North Adams, Mass. 01247
Tel. 413/664-4411



THE BROAD-LINE PRODUCER OF ELECTRONIC PARTS

Readers comment

court action against the FCC regarding our domestic satellite activities.

John R. Opel
President
International Business
Machines Corp.
Armonk, N.Y.

Diagrams off

To the Editor: Certain errors appeared in two of the diagrams that accompanied my article, "Sinusoidal clock overcomes network performance bugs" [*Electronics*, Jan. 23, p. 96].

In Fig. 4, the output is coming off the wrong side of R_L . The upper part of R_L should lead to ground. And the line immediately below R_L should be carrying the output instead of leading to ground. In Fig. 5, the symbol between amplifier A and capacitor C_L should not be a ground; it should be the symbol for a coaxial cable.

O. A. Horna
Comsat Laboratories,
Clarksburg, Md.

Work disputed

To the Editor: I believe a wrong impression was created by the International Newsletter item concerning development of a cadmium-telluride gamma-ray detector [*Electronics*, Dec. 26, 1974, p. 47]. Development of these gamma-ray detectors was not actually the work of the French firm LEP, nor did the development of the solvent-pulling technique originate with them. The latter was in its entirety developed at the Corporate Research Center of Tyco Laboratories, which has since become Mobil-Tyco Solar Energy Corp, here in Waltham. This organization has also participated in several other key developments to make the whole CdTe detector feasible.

The basic idea for such a detector originated also in the U. S., namely with J. Mayer at Caltech and with the Hughes Aircraft Research Laboratory. The latter was under AEC Sponsorship.

Fritz Wald
Mobil-Tyco Solar Energy Corp.
Waltham, Mass.

"The principal quality of any synthesizer is spectral purity." (Microwaves, Nov. 72, p. 54)

Purity is just one good reason for choosing S-D synthesizers.

Another is economy. Systron-Donner programmable synthesizers not only provide the purest signals attainable today but cost substantially less than comparable systems.

That's because Systron-Donner's approach eliminates the need for costly frequency multipliers. S-D uses octave band signal sources—1-2, 2-4, 4-8 and 8-12.4 GHz. See the difference this makes:

The old way

Frequency is multiplied,
and so is noise.



The S-D way

No multipliers.
No noise multiplied.



Comparison of phase-locked systems providing F_0 to 4 GHz.

So, in one grand stroke, S-D's design reduces unwanted noise problems, slashes systems costs, and significantly telescopes system size by eliminating multipliers. (S-D's panel is 7" high.)

S-D offers a full range of synthesizers tailored to your needs . . . from multi-channel satellite communications systems to manual or automated bench testing.

Features include: AM and FM capability, leveled outputs, fast switching, continuous sweep and stepping capability, choice of high stability oscillators, 1 Hz resolution, attenuator—the whole works.

S-D's national sales and service organization backs this product line. Contact your Scientific Devices office or S-D at 10 Systron Drive, Concord, CA 94518. Phone (415) 682-6161. For immediate details call our Quick Reaction Line (415) 682-6471 collect. **Europe:** Munich, W. Germany; Leamington Spa, U.K.; Paris (Port Marly) France. **Australia:** Systron-Donner, Melbourne.



Specifications Model 1603

Leveled output +13 dBm \pm 0.5 dB

Frequency accuracy as good as reference oscillator

Frequency resolution 10 KHz standard, 1 Hz optional

Frequency stability (internal oscillator) 3×10^{-9} per 24 hours

Phase noise -85 dB at 1 KHz from carrier in a 1 Hz bandwidth

Spurs -70 dBm minimum

Harmonics -20 dBm minimum

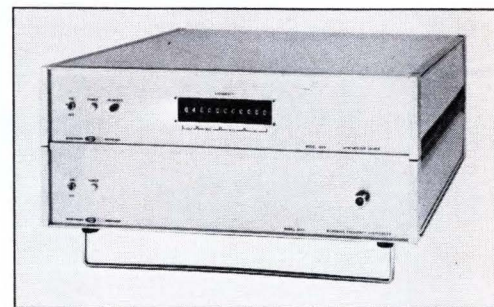

SYSTRON  DONNER

Albuquerque, (505) 268-6729; Baltimore, (301) 788-6611; Boston, (617) 894-5637; Burlington, NC (919) 228-6279; Chicago, (312) 297-5240; Cleveland, (216) 261-2000; Denver, (303) 573-9466; Dayton, (513) 298-9904; Dallas, (214) 231-8106; Detroit, (313) 363-2282; Ft. Lauderdale, (305) 721-4260; Hamden CT (203) 248-9361; Huntsville, AL (205) 536-1969; Houston, (713) 623-4250; Indianapolis, (317) 783-2111; Kansas City, KS (913) 631-3818; Los Angeles, (213) 641-4800; Minneapolis, (612) 544-1616; New York City area (201) 871-3916; Norfolk, (703) 499-8133; Orlando, (305) 424-7932; Philadelphia, (215) 825-9515; Phoenix, (602) 834-1682; Rochester, NY (716) 334-2445; San Antonio, (512) 694-6251; San Diego, (714) 249-6642; San Francisco area (415) 964-4230; Seattle, (206) 454-0900; St. Louis, (314) 842-2535; Syracuse, (315) 457-7420; Washington, DC area (703) 451-6500.

Insul-cote

A NEW PRODUCT BREAKTHROUGH FROM THERMALLOY, INC.- PRE-COATED INSULATORS FOR SIMPLE APPLICATION

If you use insulators, you should use Thermalloy, Inc.'s revolutionary new product...*Insul-cote*.

Insul-cote is a combination of Thermalloy, Inc.'s dependable Thermalfilm or other insulator materials and Thermalcote grease in an innovative packaging concept. These pre-coated insulators save production time and expense. They eliminate hand coating and cut installation time.

The reliable Thermalfilm I or II insulators are pre-coated with Thermalcote grease and individu-

ally sealed between continuous strips of heat sensitive tape. One side of the tape separates into pull tabs for easy opening. Also the tape may be peeled lengthwise to expose the coated insulators. *Insul-cote* is available in individual packets, perforated six pack strips or "ammo-pak".

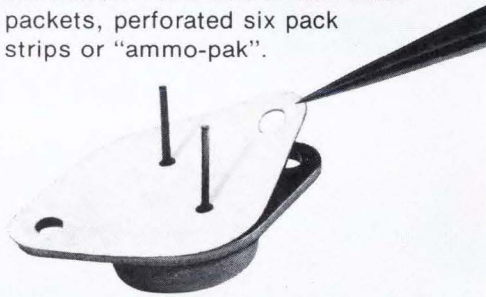

Insul-cote has a uniform coating of Thermalcote for maximum heat transfer. We guarantee a minimum coating of 1 mil. of grease on each side of the insulator.

Thermalloy, Inc.'s technical knowledge and continuing engineering research is at your fingertips with *Insul-cote*.

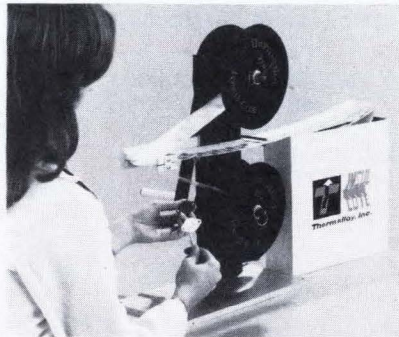

Semi-automatic *Insul-cote* dispensing machines are available for even faster installation. Activated by a ratchet handle, the machine presents the coated insulators one at a time for fast application.



Thermalloy, Inc.
Box 34829 • 2021 W. Valley View Lane
Dallas, Tex 75234 • (214) 243-4321
TWX: 910-860-5542

NUMBER ONE IN SEMICONDUCTOR ACCESSORIES

Circle 10 on reader service card

News update

■ It's an ill wind indeed that doesn't do some good. In the case of the Goldmark Communications Corp. the ill wind is the energy crisis, and the benefit for the company is the list of potential users it's signing up for its two-way stereophonic Teleconferencing system [Feb. 7, 1974, p. 53]. The system was tested last winter between offices of a bank in Connecticut, the Union Trust Co., which since has bought the pilot installation and has been using it regularly. Now the South Dakota state government is going to try to link its widespread agencies with the travel-saving Goldmark system. And several companies, both manufacturers and service firms, will be taking a look at it.

■ Solid-dielectric millimeter waveguides, scheduled for delivery in December to the Army Electronics Command's Electronics Technology and Devices Laboratory, are now expected next month. The guides are designed to replace the precisely machined and expensive conventional metal ones when used with specially designed ICs [Feb. 21, 1974, p. 31]. Harold Jacobs, team leader at the lab at Fort Monmouth, N.J., says the experimental devices will be received in April from the Illinois Institute of Technology Research Institute in Chicago and from the Hughes Aircraft Co. facility in Torrance, Calif. Both are to deliver 60-gigahertz devices. The objective is circuits that are much more compact than conventional "plumbing" and that may cost a tenth of today's millimeter-wave circuits.

■ The IEEE has adopted an instrument-interface-bus standard, based on the Hewlett-Packard concept, that's still in the works at the International Electrotechnical Commission [Nov. 14, 1974, p. 95]. No obstacles to worldwide adoption are foreseen; it's just that the process of translation, comparison, and approval is a time-consuming one.

—Howard Wolff

Now. The people who make the world's fastest comparator make the world's fastest dual ECL comparators.

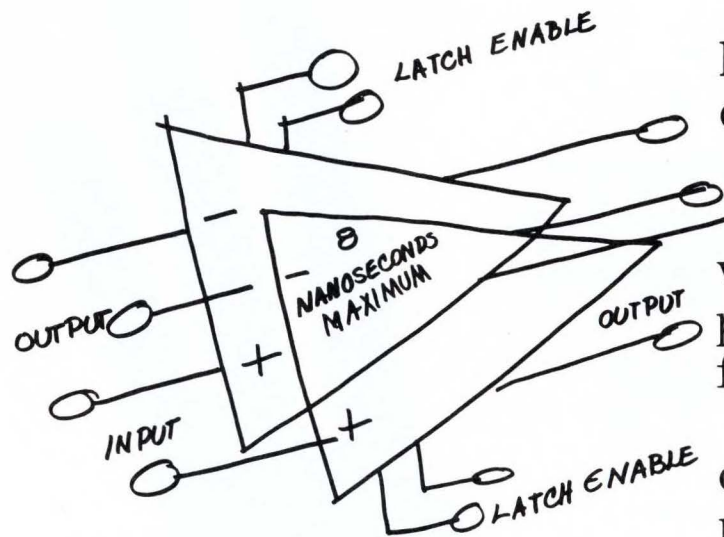

You remember the Am685:
7½ns propagation delay.
3ns set-up time.

Data processing above
100MHz. Terrific, right?

But if you thought it was
an only child, you're wrong.
Mama just had twins.

The Am687A.

Works off standard 5V
supplies and consumes 25%

less power than two single
devices. It features an
improved differential latch
drive and a 2mV offset
voltage for accomplishing
precise sample and hold
functions.

Complementary ECL
outputs plus 8ns maximum
propagation delay and 4ns
maximum set-up time allow
data processing rates above
100MHz. (If time is money
our standard Am687 only
costs you two nanoseconds.)

The Am685 & Am687s.
ECL and Dual ECL. Watch
for our TTL comparator.
We're going to have the high-
speed comparator market by
the sockets.

Advanced Micro Devices

Corporate offices are at 901 Thompson Place, Sunnyvale, California 94086. Telephone (408) 732-2400 or toll free from outside California (800) 538-7904/Southern California: Beverly Hills (213) 278-9700/Mid-America: Oak Brook, Illinois (312) 323-9600/Edina, Minnesota (612) 835-4445/Dallas, Texas (214) 423-1502/Eastern United States: Roslyn Heights, New York (516) 484-4990/E. Syracuse, New York (315) 437-7546/Baltimore, Maryland (301) 744-8233/Wellesley, Massachusetts (617) 237-2774/Britain: Advanced Micro Devices, Telephone 01-730-0855/West Germany: Advanced Micro Devices, Munich, Telephone (089) 53 95 88/Southern Europe: Advanced Micro Devices, S.A. Neuilly, France, Telephone 747-4194/Japan: Advanced Micro Devices, K.K., Telephone (03) 346-0363. Distributed nationally by Hamilton/Avnet, Cramer and Schweber Electronics.

SIEMENS

When you think Zeners, think Siemens

From low-cost commercial to highly sophisticated, ultra-reliable applications, Siemens has the voltage regulating (Zener) diodes and the voltage reference (TC) diodes you need. And, even if you use one of our 11¢ devices, you have the assurance that every Siemens Zener has a built-in quality that can only come from the leader in hi-rel Zeners.

Siemens offers 48 popular JEDEC series, plus thousands of custom and proprietary devices in one of the most extensive lines of commercial and military Zeners. With this product breadth, available from our specialized Zener production facilities in Arizona, it's no wonder Siemens is looked upon as the preferred Zener source by thousands of major equipment and systems manufacturers worldwide.

When you need Zener diodes, consider the extra quality and the fast service benefits you'll receive from "the Zener specialists" . . . Siemens. For the name of your nearest Siemens U.S. sales office, PHONE TOLL FREE (800) 645-9200 (call collect in New York (516) 294-0990).

Siemens: Where Quality And Resources Make The Difference.

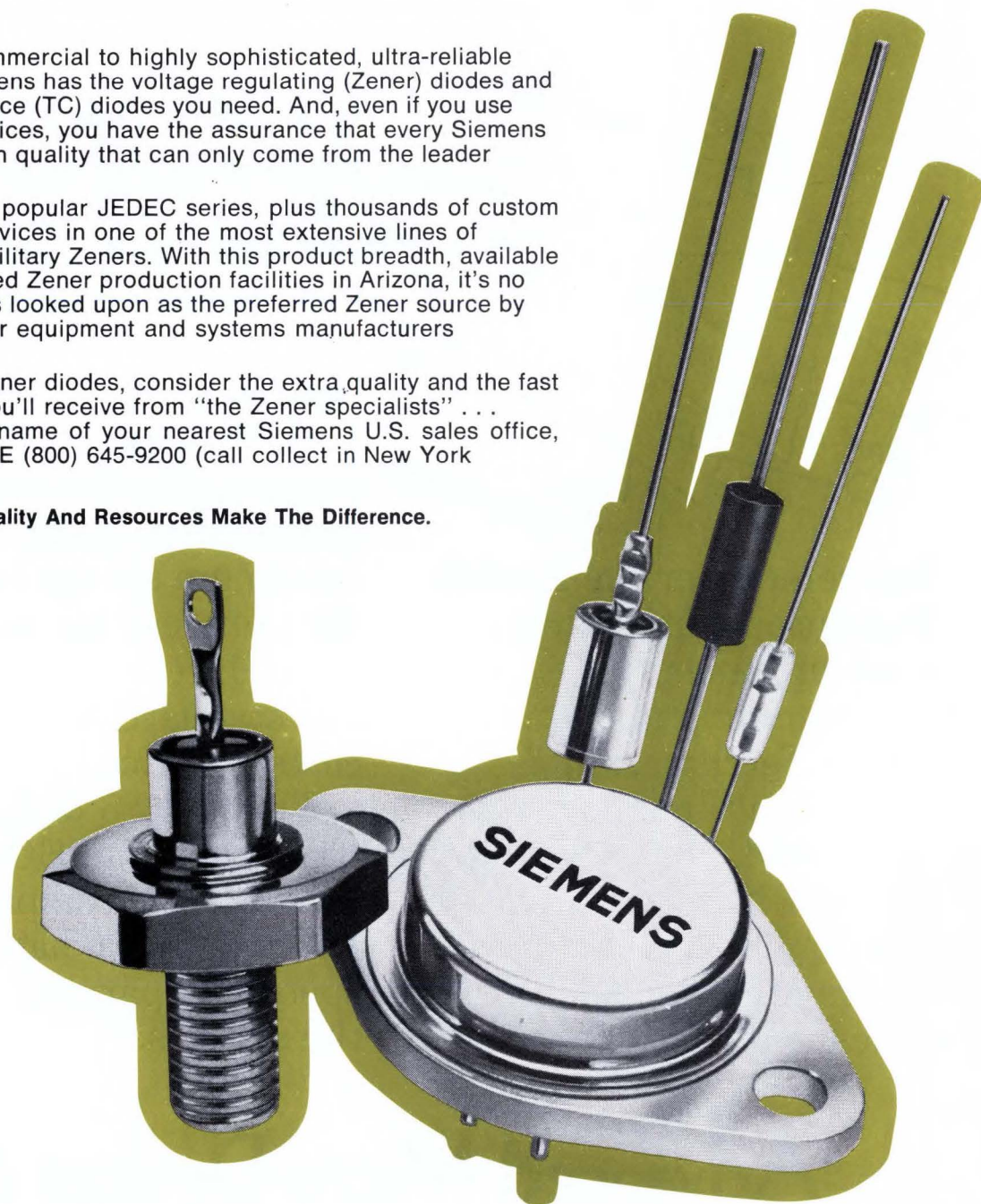

Siemens Corporation
Components Group

P.O. Box 1390, Scottsdale, Arizona 85252
(602) 947-2231 TWX 910-950-1292 Telex 667-406

Advice to the President on science

Now, more than ever, the voice of the nation's scientists and engineers should be heard loud and clear in the highest reaches of Government. The trouble is, their words are muffled by layers of lower-level bureaucracy, seemingly disregarded even when asked for, and—despite today's technologically oriented problems—seldom solicited.

One reason is the lack of a well-defined, strongly based science advisory office attached to the White House. The President's Science Advisory Committee, among other things, was instrumental in the formation of NASA—and the space programs that did so much to boost American prestige around the world. But it was phased out, and its replacement, the Office of Science and Technology, eliminated in the Nixon Administration.

Yet there is a crucial need for a Government office that can advise the President about the scientific and technological implications of policy decisions. It would parallel his present advisers who assess the political, economic, social, military, and international aspects of policy choices.

And so much of what the Government has to deal with these days—from easing our dependence on foreign oil supplies to arms limitation talks, from increasing industrial productivity to improving mass transit—cries out for wider participation by the the nation's engineers and scientists. Now, the National Science Foundation, which is in effect the lobbyist for science in the fight for Government funding, has been called on to somehow shed that role and be an objective, unbiased adviser on the scientific implications of policy actions. But the NSF is in no position to tackle the immense task that stymied even PSAC and OST: the coordination of the Government's over-all R&D efforts.

President Ford, recognizing the inadequacies of the present Federal science advisory and management structure, has commissioned a study on how best to rejuvenate that important function. And he need not be bound by the past practice of seeking guidance largely from the academic community. Indeed, in view of some short-term national needs, an argument can be made that an engineer with a knowledge of project costs—and tradeoffs—would be better suited to the job than would be someone from the academic world. At the least, a blending of industrial and academic expertise is needed.

The President has a number of options, but he has no choice when it comes to reestablishing a strong science advisory office. Whether headed by one person or a committee, that office must have well-spelled-out responsibilities, including:

- *providing inputs that help determine national priorities*
- *assessments of the technological impact of political alternatives*
- *early warning of long-range technologically based problems, complete with an analysis of the pitfalls and potential of the various solutions*
- *a major role in defining national R&D goals, and, if necessary, rechanneling the R&D efforts of other Government agencies, especially in areas where duplication and waste are spotted.*

All this requires assembling a staff with expertise in a wide range of disciplines. And most important it requires clout, the kind of leverage in prying cooperation out of the many, often secretive department officials and agency managers that only the full and active support of the President can give.

In this time of economic crisis, such an advisory body might be considered a luxury. But it is really a cost-effective route for ensuring that we do not lose the technological leadership so important to our position in the world today.

a little A-300 goes a long way.



In high frequency transmission. RF power generation for industrial and research processes. RFI/EMI and general laboratory applications, too.

The Model A-300 is a totally solid state power amplifier, covering the frequency range of 0.3 to 35MHz with a gain of 55dB. Capable of delivering 300 watts of linear Class A power and up to 500 watts in the CW and pulse mode, the A-300 is the ultimate in reliability.

Although the unit is perfectly matched to a 50 ohm load, it will deliver its full output power to any load (from an open to a short circuit) without oscillation or damage.

Complete with power supply, RF output meter and rack mount, the A-300 weighs a mere 89 pounds and operates from ordinary single phase power.

High power portability goes a long way for \$5350.

For further information or a demonstration, contact ENI, 3000 Winton Road South, Rochester, New York 14623. Call 716-473-6900 or TELEX 97-8283 ENIROC

ENI

The World's Leader
in Solid State
Power Amplifiers

People

Zenith's serious about audio; just ask Barry Kipnis

"Zenith won't introduce a new audio development only for the sake of being first. Rather, we simply will design equipment for our market." This is the thinking behind Zenith Radio Corp.'s continuing competi-



Audio man. Chief engineer Kipnis says Zenith's hi-fi components should do well.

tion in the hi-fi stereo components market, says Barry Kipnis, the company's new director of radio and stereo engineering.

Chicago-based Zenith, noted more for its leadership in television receiver sales than anything else, had until recently been marketing the single-unit audio consoles preferred by a mass merchandiser. But "there's a market in components for Zenith," states Kipnis, a 34-year-old electrical engineer with a master's degree in business administration. And because of what he regards as an "audio engineering department that's the equal of any in the hi-fi industry," he's out to see his company excel in this field.

"Our engineers have learned techniques for designing consoles that have been very useful when transferred to components," he remarks. He says he's prepared, for example, to match Zenith's medium-priced Allegro "tuned port" speakers, which optimize low-frequency response, against any com-

parably rated competitors.

Kipnis, who has held various engineering posts at Zenith since 1966, also points out that Zenith's distribution system makes it possible to sell products in appliance and department stores as well as in audio specialty shops. Moreover, to provide more flexibility to both its dealers and customers, Zenith will "unbundle" its components line starting this spring. With this arrangement, eight- and 16-ohm-impedance speakers could be matched to any of Zenith's stereo amplifiers, rather than requiring consumers to accept "pre-packaged" company-matched components. Zenith will also be ready, Kipnis points out, with a receiver/tuner compatible with whichever of the half-dozen proposed discrete four-channel broadcast systems is finally accepted by the Federal Communications Commission. At present, it appears this decision will not be made until June. And it could be almost a year before the first broadcasts begin.

Nevertheless, Kipnis agrees with the rest of the hi-fi industry that the arrival of discrete four-channel broadcasting will definitely spur equipment sales for what has till now been a rather disappointing line. And he believes the components business will spur sales for Zenith as well.

Bob Lloyd: at National Semi
he likes the gutsy approach

After you've founded, nurtured and served as president of your own company, only to see it face financial hardship and have yourself eased out of the driver's seat, what kind of new challenge would turn you on? For Robert H.F. Lloyd, new group director of metal-oxide-semiconductor LSI at National Semiconductor Corp., there had to be the promise of plenty of action.

The tall, 40-year-old engineer-entrepreneur founded Advanced Memory Systems Inc. in 1968 after almost eight years with IBM where he was deeply involved in that com-

The I.C. Obstacle Course

You end up with a better product, fewer field service calls... and happier customers

Enter: Good Guy Or Bad Guy?

Testing catches the 2 or 3 obviously dead devices in a typical batch of 100 IC's or semiconductors. However, it takes pre-conditioning to uncover the 3 or 4 (or more) additional weaklings that will probably fail after your product has been delivered to a customer where a field service call could cost hundreds of dollars.

That's why you should send your IC's to our regional Microelectronic Testing Labs (MTL's). Here's how the IC obstacle course works.

First: Thermal Shock

Thermal shock, which consists of alternately immersing IC's in 0°C to 100°C liquids from 3 to 15 times, duplicates in minutes the stress devices would experience in a lifetime. Mechanically sound components show no ill effects. Weak IC's develop broken bonds, chip fractures, poor passivation, etc., which would never have been uncovered by testing alone.

Next: Burn-In

Devices are now aged in a burn-in chamber for up to 168 hours at 100°C (which equals 5,000 hours at 50°C) with bias applied. Burn-in will turn up contaminated die, faulty diffusion processes, micro-cracking and passivation problems which will show up in final test. By compressing 8 months into a week, failure trends can be spotted.

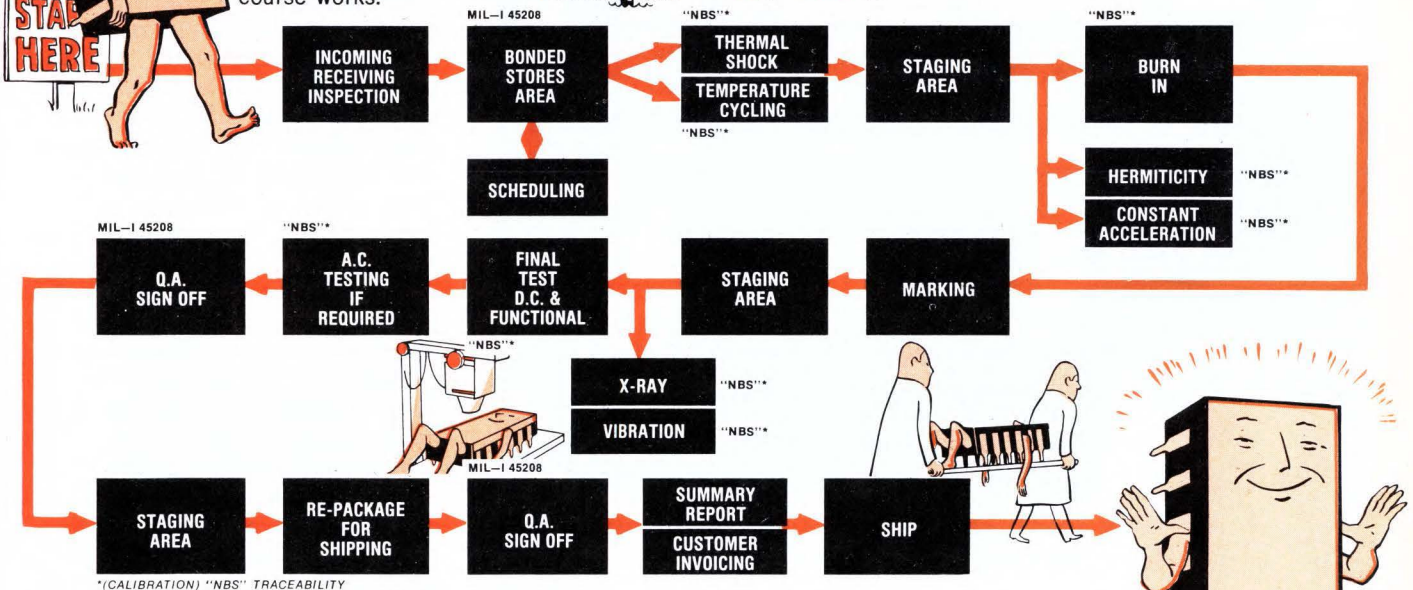
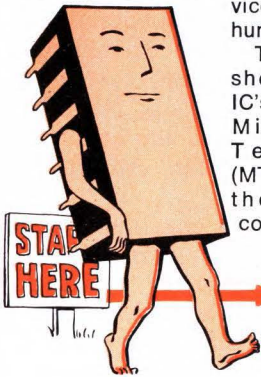

Finally: DC/Functional Testing

Only now are devices tested using high speed, computer-controlled test systems and specialized equipment such as analog testers, curve tracers, sampling scopes, etc. Tests are parametric, functional — or whatever is required. Devices which fail are shipped back for credit, which sure beats having them end up in your product or system.



The Devices We Test	The Tests We Perform
Diodes	D.C. Functional
Rectifiers	A.C. Life
SCR's	Screening
Triacs	Sorting
Power Transistors	Burn-In
Small Signal Transistors	Thermal Shock
Unijunction Transistors	Temperature Cycling
Field Effect Transistors	Hermiticity
Digital Integrated Circuits	Constant Acceleration
Linear Integrated Circuits	X-Ray
M.S.I. Integrated Circuits	Vibration
L.S.I. Integrated Circuits	
Hybrid Circuits	
Semiconductor Memories	

We Separate The Good Guys From The Bad Guys

Now you know why you should send your IC's and semi's to one of our regional MTL centers — as hundreds of companies do. We separate the good guys from the bad guys so you'll end up with a better product, fewer service calls — and happier customers.

Call us today — or send for our brochure.

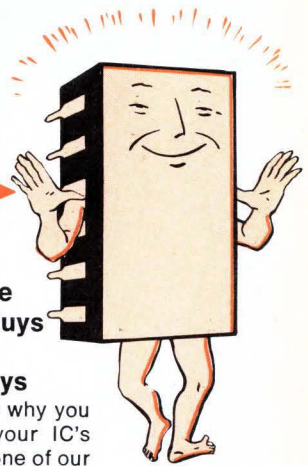

mtl MICROELECTRONIC TESTING LABORATORIES a division of Datatron, Inc.

17312 GILLETTE AVE., SANTA ANA, CA. 92705, (714) 546-5551 • 11 ESQUIRE RD., NO. BILLERICA, MASS. 01862, (617) 667-2191
178 WARREN ALLEN DRIVE, WOOD DALE, ILL. 60191, (312) 595-0440

THE LID'S OFF

THE AIRPAX PARKERMETER SERIES ER-35 CONTROL METER



the finest solid state edge
reading meter available today

FEATURING

- Unique Design • Improved Switching
 - Rugged precision molded case
 - More reliable meter movement
- State of the art manufacturing throughout
 - Horizontal or vertical displays
- Only 7/8" thick (can be stacked in any quantity)
- Available with one or two setpoints providing four control switching configurations

MORE QUESTIONS?

Write for Catalog 0200D. It tells all about the Airpax Parkermeter product line . . . truly the most modern and dependable of all.

AIRPAX Controls Division P.O. Box 8488
Fort Lauderdale, Florida 33310 Phone: 305/587-1100

AIRPAX™

People

pany's shift to semiconductor memories. In five years he built AMS into a \$30-million-a-year semiconductor-memory house. Then last year, in a gamble to corner most non-IBM memory systems, AMS overextended itself, and Lloyd was no longer president.

"After the wild, exciting roller-coaster ride at AMS, it would be hard to find a business environment quite as challenging," says Lloyd, who is now in charge of National's calculators, watches, and standard and custom LSI products, "But despite its previous image as an unimaginative, rather unambitious company, technologically speaking, National is going to be where the action is over the next few years. And that's why I'm here."

Hard-nosed. For one thing, says Lloyd, National is jumping into market areas that many firms are afraid to commit themselves to totally. "But National is doing it in a gutsy, hard-nosed, well-thought-out and profit-oriented way that eliminates a lot of the gamble. And there's nothing I admire more than guts."

A good example, says Lloyd, has been National's entry into the consumer marketplace. "There's an unspoken rule the industry has applied—erroneously—to the consumer marketplace," he says. "It is: 'don't compete with your customers.'"

"The approach here is: 'Why not compete with your customers as an end-product manufacturer if that's where the profits are?'"

This attitude, he says, has earned for National an increasingly stronger position in the calculator and watch marketplace. Lloyd hopes to extend things further.

"In this industry, we talk a lot about the so-called 'pervasiveness' of semiconductor technology," he says. "But when you look at the potential of the technology and the pitifully little we have done with it, it's a crime."

Lloyd hopes to make things happen. "Rather than following the rest of the industry technologically, National will be doing the leading," he asserts.

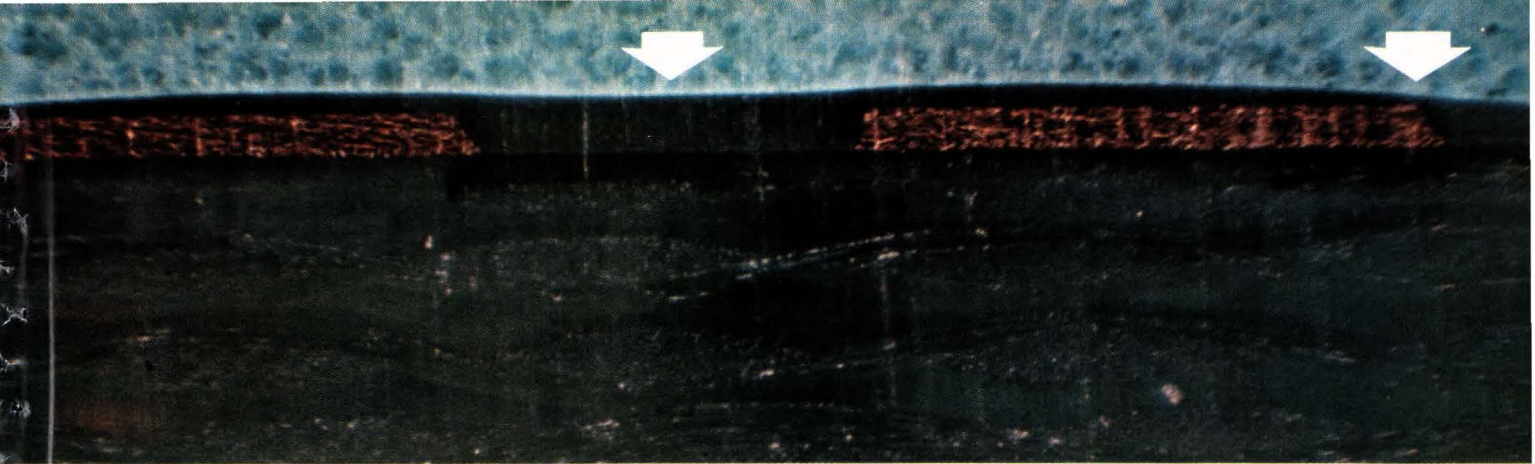

When spray or dip coatings fail...

Parylene works.

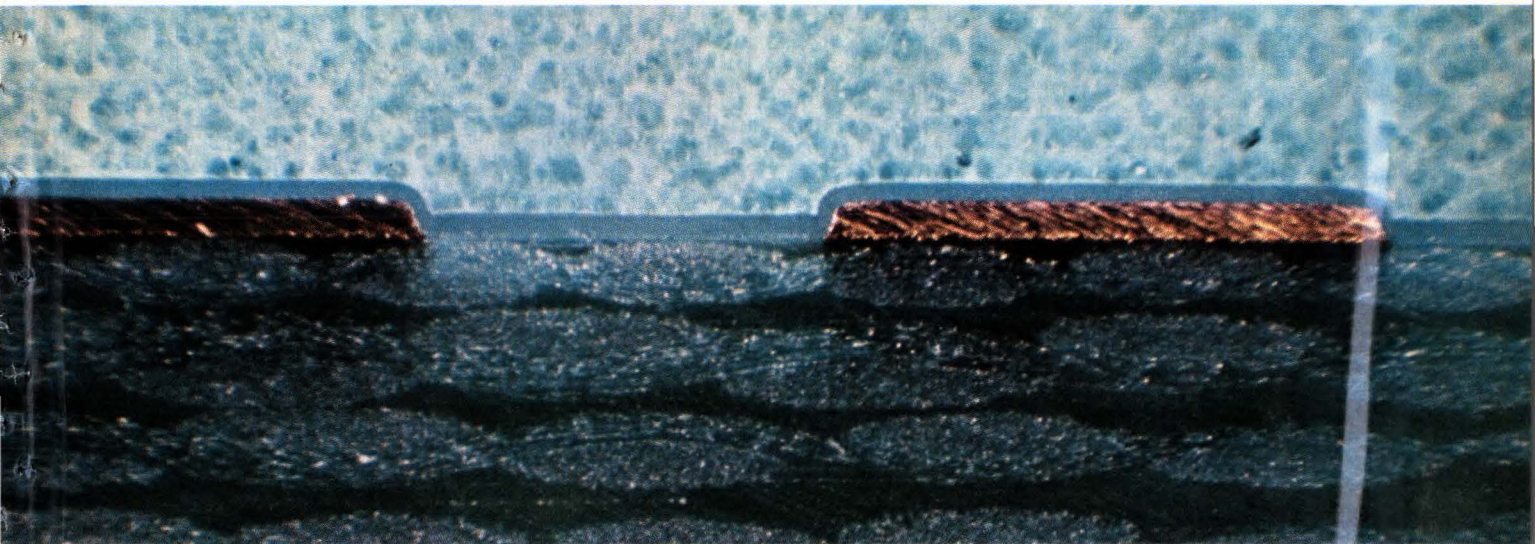

You are looking at magnified cross-sectional views of copper conductors on a circuit board . . . and why parylene protection brings the highest reliability to electronic circuitry.

The spray-applied urethane coating (top photo) bridges the channel between conductors, and offers scant protection at the edges. Urethane, silicone, epoxy . . . liquid coatings are uneven, and can produce potential failure points.

Parylene forms a thin and even coating, whatever the configuration, however complicated or delicate or densely populated. Without bridging. Without pinholes, voids, bubbles. We call it a conformal coating. From conformality comes reliability.

Parylene conformal coatings can be applied in precisely controlled thicknesses from 0.002 to 3 mils. *In one step.*

Parylene is applied at *room temperature*. No heat, no melting, no cure. No coating shrinkage. In other words, no discomfort for delicate components.

Parylene provides better barrier protection than urethanes, silicones or epoxies. It is extremely resistant to chemical attack,

exceptionally low in trace metal contamination, and compatible with all electronic solvents. Dielectrics are excellent.

Parylene has qualified under the stringent requirements of MIL-I-46058C; it does so with a 0.6 mil coating—parylene excels in the micro-electronic virtue of thinness.

Parylene conformal coatings have shown excellent cost effectiveness in many applications. On delicate, sophisticated and complex circuitry, in hybrid circuits and components, they may be the most cost effective answer for long term reliability.

Union Carbide invented the parylene system. The method is gas phase deposition, which is the only route to the reliability of conformal protection. Various patents apply; commercial use of the patented technology is licensed.

You can get complete information on parylene by writing for our 16-page brochure: Union Carbide Corp., 270 Park Ave., Dept. RB36, New York, N.Y. 10017. Further investigation will no doubt indicate a trial run, which we can perform at reasonable cost. If you would like to discuss that or any other related matters, please call Bill Loeb at (212) 551-6071.

**UNION
CARBIDE** PARYLENE

Build faster systems Intel's microcomp

Now you can build a limitless variety of high speed, high performance

INTEL'S SERIES 3000 SCHOTTKY LSI	
3001	MICROPROGRAM CONTROL UNIT
3002	CENTRAL PROCESSING ELEMENT
3003	LOOK-AHEAD CARRY GENERATOR
3212	MULTI-MODE LATCH BUFFER
3214	INTERRUPT CONTROL UNIT
3226	BIDIRECTIONAL BUS DRIVER
3601	1024-BIT BIPOLAR PROM (256X4)
3604	4096-BIT BIPOLAR PROM (512X8)
3301A	ROM (COMPATIBLE WITH 3601)
3304A	ROM (COMPATIBLE WITH 3604)
3106A	256-BIT RAM (THREE STATE)
3107A	256-BIT RAM (OPEN COLLECTOR)

logic systems at low cost with a handful of Intel's new Schottky LSI microprogrammable computing elements. This is the first bipolar family with a total systems concept built into every part. Your system will be faster and far

more universal than hard-wired TTL, when you choose the right Series 3000 configuration for your product line. Our flexible, microprogrammable architecture lets you tailor system speed, size, logic functions, bus structures and data paths to your own needs.

And your design will cost much less than hard-wired TTL. Series 3000 LSI computing elements inexpensively replace 60 to 80 percent of the MSI/SSI components previously required in peripheral controllers, DMA channel controllers, mini-computer and midcomputer central processors, data communications concentrators and processors, industrial machine and process controllers, and other high-speed systems.

Each Central Processing Element is a complete 2-bit data processing slice with built-in functions that simplify system operation. The Microprogram Control Unit is a powerful state sequencer, used to select microinstruction sequences from microprogram memory.

More than 6.5 million microinstructions per second can be executed by the typical 16-bit central processor shown here. To further enhance throughput, multiple-bit data shifts, masking and bit testing, macroinstruction program counter maintenance, and basic register-to-accumulator operations have all been reduced to one microcycle.

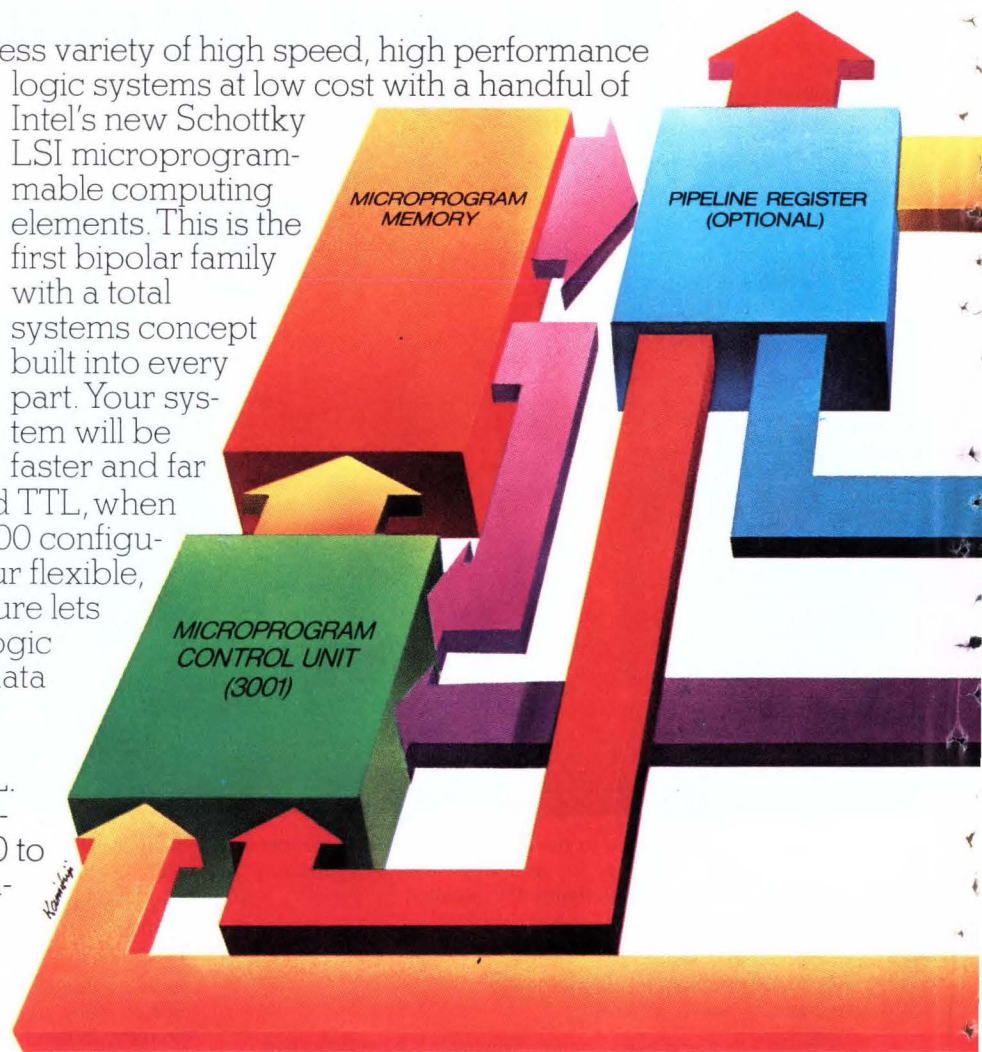

at half the cost with computing bipolar LSI.

No external buffers or multiplexers are shown in the data bus structure because none are needed. The bus structure is variable and the Central Processing Array, microprogram memory, interrupt and I/O structure can be tailored to suit the application.

Start exploring your own logic universe with Intel's WF 3000 Bipolar System Development Kit.

It contains design aids, two Microprogram Control Units, ten Central Processing Elements and ten 3601 PROMs—more than enough Schottky LSI building blocks for a typical system. Our kit updating program also entitles you to receive without further charge, selected samples of new Series 3000 family members as they are announced in 1975 and priority mailings of additional design aids. The kit is available from your local Intel distributor for only \$570. We'll send you a Look-ahead Carry Generator, Interrupt Control Unit, Multi-mode Latch Buffer and Bidirectional Bus Driver directly and follow up with more samples later. Or, you can buy our Series 3000 computing elements in production volume and build high

performance systems for as little as half the cost of TTL. All elements are in stock.

For more information on Series 3000 Computing Elements, write Intel Corporation, 3065 Bowers Avenue, Santa Clara, California 95051.



intel® Microcomputers. First from the beginning.

Dialight sees a need:

(Need: The widest choice for your every application.)



739 SERIES Save design time and installation costs . . . this LED display assembly is attractively designed in a convenient package with bezel and is ready for instant panel mounting. Available in groups of one or more characters, with or without decoder/driver . . . characters are 0.625" and come with either green or red LEDs in seven-segment format. Read-out offers lowest cost per character for comparable size.

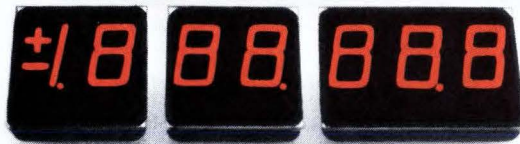

755 SERIES High brightness planar gas discharge displays in a 0.550" character. Orange color gives high contrast ratio and allows readability to 40 feet even in high ambient lighting. Designed for interfacing with MOS/LSI, displays have an expected life of 100,000 hours or more.



Dialight, the company with the widest choice in switches, LEDs, indicator lights and readouts, looks for needs . . . your needs . . . and then they develop solutions for your every application. No other company offers you one-stop shopping in all these product areas. And no other company has more experience in the visual display field. Dialight helps you do more with these products than any other company in the business, because we are specialists that have done more with them. Talk to the specialists at Dialight first. You won't have to talk to anyone else. Send for your free new copy of Dialight's current catalog.

DIALIGHT

Dialight, A North American Philips Company
203 Harrison Place, Brooklyn, N. Y. 11237
(212) 497-7600

See Dialight.

Meetings

Industrial Applications of Microprocessors, IEEE, Sheraton Hotel, Philadelphia, Pa., March 11-12.

Reliability Physics Symposium, IEEE, MGM Grand Hotel, Las Vegas, Nev., April 1-3.

Fourth Annual Symposium on Incremental Motion Control Systems and Devices, University of Illinois Electrical Engineering Department, Urbana, Ill., April 1-3.

Paris Components Show, (*Salon des Composants Electroniques*), Porte de Versailles, Paris, April 2-8.

Southeastcon '75, IEEE, Sheraton Center, Charlotte, N.C., April 6-9.

Intercon-IEEE International Convention, Coliseum and Americana Hotel, New York, N.Y., April 8-10.

Intermag-International Magnetics Conference, IEEE, Imperial College, London, England, April 14-17.

Electronics Production and Test Equipment Exposition, U.S. Department of Commerce, Stockholm, April 7-11; London, April 15-18.

International Circuits & Systems Symposium, IEEE, Marriott Motor Hotel, Newton, Mass., April 21-23.

Reliability Software International Symposium, IEEE, International Hotel, Los Angeles, April 22-24.

Society for Information Display International Symposium, SID, Shoreham Americana Hotel, Washington, D.C., April 22-24.

International Optical Computing Symposium, IEEE, Mayflower Hotel, Washington, D.C., April 23-25.

National Relay Conference, NARM and Oklahoma State University, Stillwater, Okla., April 30-May 1.

Electronic Components Conference, IEEE, EIA, Statler Hilton Hotel, Washington, D.C., May 12-14.



YOU'RE LOOKING at the PERFECT SOURCE for CRYSTALS, OSCILLATORS and CRYSTAL FILTERS

ERIE is bursting with a full line of QUARTZ CRYSTALS . . . with deliveries to meet your production schedules. 1 kHz to 200 MHz . . . AT, JT, DT, NT, SL, 5°X, GT.

We have exotic crystals and very simple crystals, low frequency and high frequency crystals. And we manufacture and test to meet or exceed Mil-C-3098 standards. ERIE provides a better crystal because we control our total manufacturing process in-house.

Our broad line of CRYSTAL OSCILLATORS range from low cost TTL dip package types to complex high stability, high reliability oscillators . . . both military and industrial types.

When it comes to CRYSTAL FILTERS, ERIE can design and manufacture the filter best suited to your application. There is virtually no limit to the variety we produce . . . including Monolithic Crystal Filters.

So come to ERIE for a fast, accurate and down-to-earth answer to your frequency control problem. One factor remains constant . . . you'll get a fair, cost-conscious answer. We have the technology and the products to implement effective crystal performance.

WRITE FOR OUR CATALOG
OR CALL 717/249-2232
FOR ENGINEERING AND
PRICING HELP.

ERIE FREQUENCY CONTROL
453 LINCOLN ST., CARLISLE, PENNSYLVANIA 17013
DIVISION OF ERIE TECHNOLOGICAL PRODUCTS, INC.



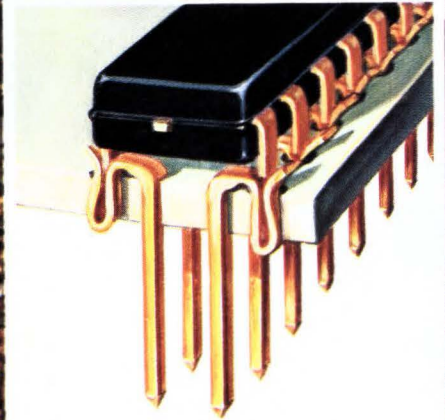
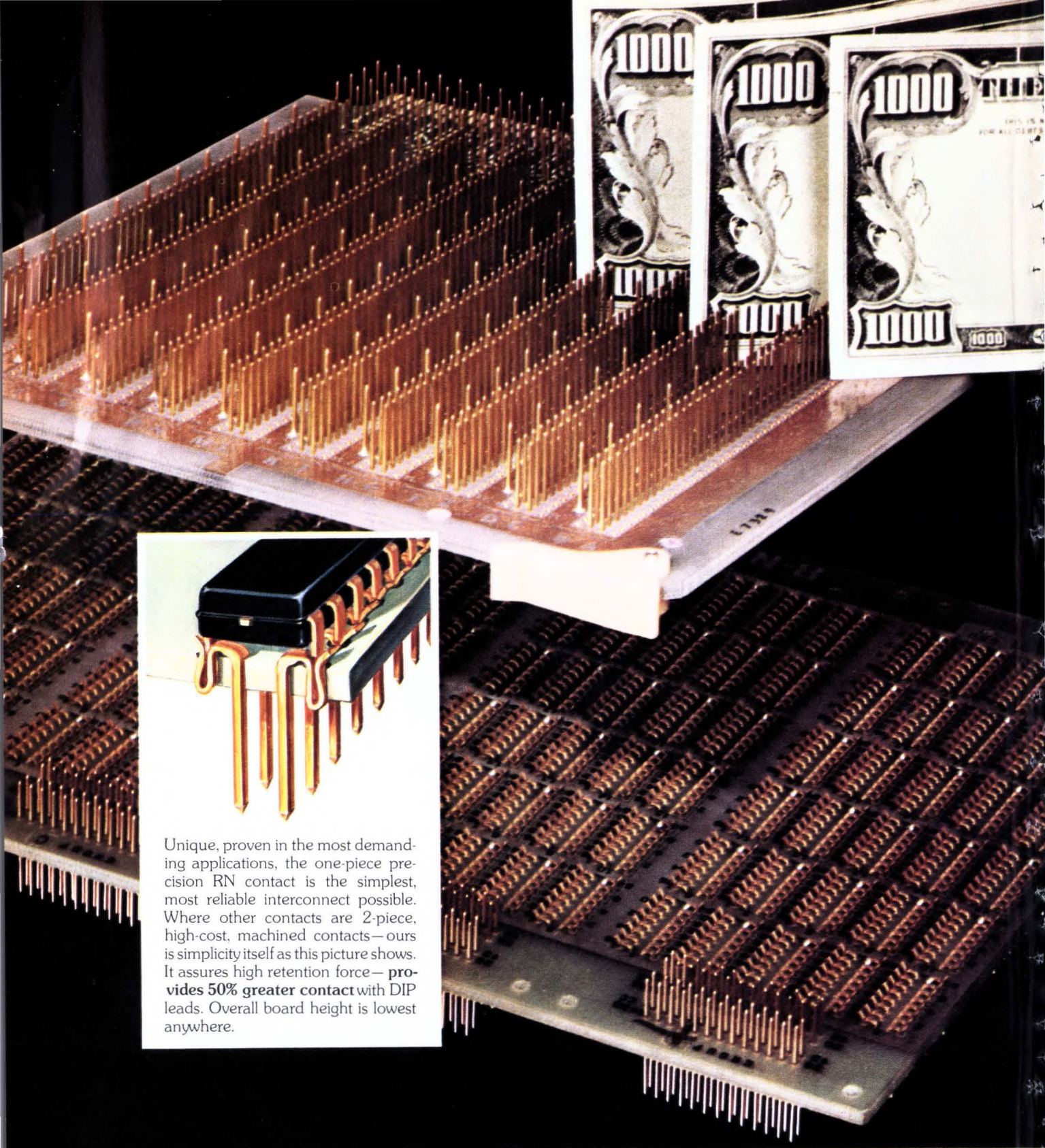

Unique, proven in the most demanding applications, the one-piece precision RN contact is the simplest, most reliable interconnect possible. Where other contacts are 2-piece, high-cost, machined contacts—ours is simplicity itself as this picture shows. It assures high retention force—**provides 50% greater contact** with DIP leads. Overall board height is lowest anywhere.

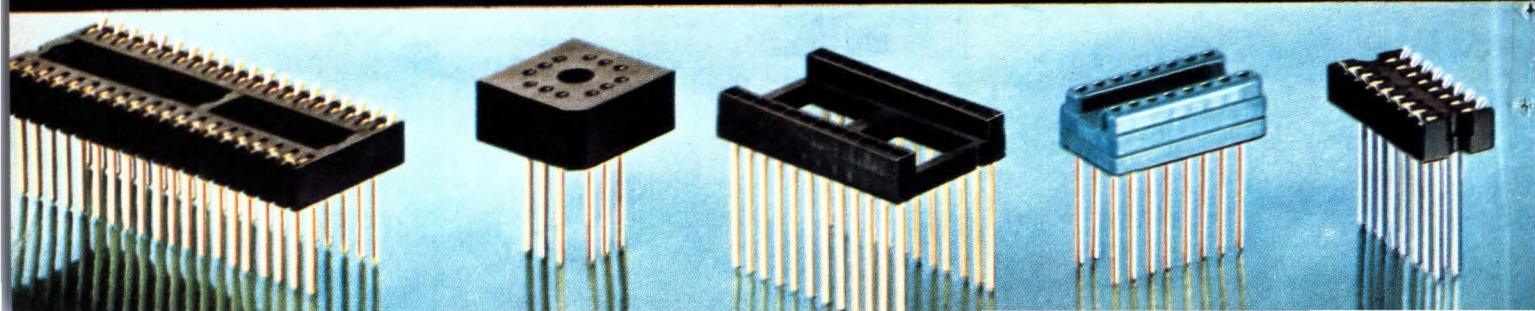

Save \$3,000... get 10-day delivery

Switch to Robinson-Nugent Wire-wrap* Socket Boards

Save 30%! By specifying RN high reliability Wire-wrap Socket Boards—your \$10,000 production order will cost only \$7,000! Sound impossible? More and more quality, cost-conscious firms are discovering that the same simple RN one-piece contact construction that reduces the cost by 30%—also brings added reliability, higher contact retention. Many say that RN Wire-wrap Socket Boards provide the most reliable, rugged solderless interconnect system available.

“Environmental Test Program” done by independent test lab reveals RN Wire-wrap Socket Boards meet or surpass the toughest MIL-specs. Summary of tests in latest RN catalog. Write for it today.

On production-size orders we'll pay for the reprogramming of your Wire-wrap tapes. What could be easier than switching to RN?

These cost-conscious firms are saving with RN high reliability Wire-wrap Socket Boards

Texas Instruments	Bendix Aerospace
Motorola	Hughes Aircraft
NCR	RCA
Airborne Instruments	Sandia Labs
Lockheed Electronics	General Dynamics



Send today for catalog with full details and specifications. Start now to save 30% on your Wire-wrap Socket Boards.

RN ROBINSON NUGENT, INC.

800 East Eighth Street • New Albany, Indiana 47150 • Phone: (812) 945-0211

Circle 23 on reader service card

*Trademark of Gardener-Denver Co.

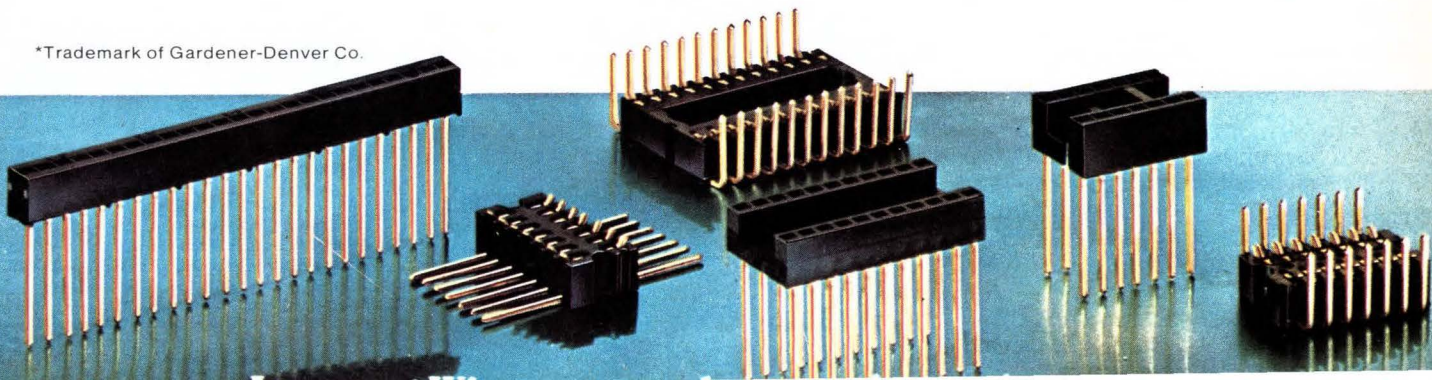



When it comes to picking the right 4½ digit multimeter, are you drowning in a sea of sales claims?

Check the Fluke truth table for all the important facts.

	4½ Digit Multimeter Competitors #										FLUKE 8600A
Five-range AC/DC volts to 1200V											•
Five-range AC/DC current to 2A			•						•		•
Six-range resistance to 20 megohms					•			•	•		•
Autorange through all ranges plus individual range selection manually									•		•
10,000 Hour demonstrated MTBF											•
Continuous overload specified for all ranges/functions with overload indication									•	•	•
Environmental capability specified and defined											•
Automatic zeroing		•	•				•	•			•
Full line of accessories offering HI volts to 40 KV, RF to 500 MHz, current to 600A											•
Rechargeable battery option, completely built-in and self-contained						•		•	•	•	•
7W or less power consumption for reliability									•		•
Basic DC accuracy of 0.02% for 90 days at 15° C to 35° C		•									•

Ten companies claim to offer a 4½ digit multimeter competitive to the Fluke 8600A. As you can see from the truth table, no one measures up to Fluke. Some have more features than others. None have all the fine features of the Fluke 8600A. For a modest \$649 (U.S. price), you can put the 8600A to work right away.

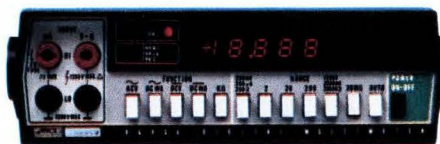

John Fluke Mfg. Co., Inc., P. O. Box 7428, Seattle, WA 98133. For data out today, dial our toll-free hotline 800-426-0361. For a demo circle 24. For literature only, circle 25. For information on the rest of the Fluke line see our ad in EEM or the Gold Book.

Bell Labs trims technical staff first time since '30s

Bell Laboratories is reducing its technical staff **for the first time since the Great Depression**. Calling it a "special personnel adjustment program," Bell is offering staff members—from laboratory assistants up through professional engineers and scientists—an opportunity to resign voluntarily with a termination allowance. It is also selecting some for "involuntary termination." Altogether, **only about 150 persons out of a total of 9,800 may be affected.**

The program is necessary, says a spokesman, because of the "effects of inflation and the reduction of military work, although our budget is as high as it has ever been."

Survey lists U.S. firms with East Europe ties

A confidential survey of U.S. companies doing business in Eastern Europe has turned up a list of 250 American firms, many of them in electronics. The survey, being conducted by Indiana University's International Development Research Center under contract to the Commerce Department's Bureau of East-West Trade, **so far has identified about 55 U.S. companies in the "electrical machinery" category.** Paul Marer, director of the research center's East Europe program, says that most of these agreements involve electronics to some degree. Because of the confidential nature of the study, the companies will not be identified.

Data General readies first business line

Data General Corp. is introducing its **first line of computer systems for business applications**. Built around its Eclipse medium-scale 16-bit computer and called Eclipse C/300, it will have a new Eclipse processor with an added commercial instruction set and new microcode.

Instructions include a feature, heretofore available only on large-scale systems such as the IBM 370/155, called data-base file-management orientation. Briefly, **this permits data to be accessed in different ways even though it has been entered only once.** The C/300 is aimed at the gap between the low end of the 370 line and the upper end of small-computer systems.

Signetics to make three parts in Intel 3000 series

Calling it "the industry's first multiple-sourced bipolar microprocessor set," Signetics Corp. of Sunnyvale, Calif., is planning to **second-source three device types in the Intel Corp.'s 3000 series**—the 3001 micro-programmable control unit, the 3002 two-bit central processing element, and the 3214 priority interrupt control unit. The balance of the set, however, will consist of Signetics' standard Schottky TTL ROM/PROM, RAM, and interface functions.

Stan Bruederle, Signetics' marketing manager for bipolar microprocessors, says the company **does not intend to manufacture all of the Intel bipolar microcomputer parts.** "It is our feeling that it is to the customer's advantage," he explains, "to use industry standard products rather than choose a 3000 sole-source product." Prototype sample quantities of the 3001 and 3002 will be available in April, he says, with volume quantities in August. The company intends to produce the 3214 during the fourth quarter.

Rockwell to sell modem family to OEMs

Rockwell International has developed a new series of modems, based on previous custom designs, that will be available to OEMs in two or three months. The firm's Microelectronic Device division in Anaheim, Calif., will not sell the MOS LSI chips, **but will offer a pc board of electronics with custom interfaces.** The modems, which will operate at 2,400, 4,800, 7,200, and 9,600 bits per second on dial-up lines, are designed to be incorporated into high-speed facsimile or data-communications terminals.

Rockwell plans to offer the 4,800 bps capability in an eight-phase CCIT scheme for European customers and a four-phase quadrature amplification version for domestic users. Rockwell will not discuss prices, but an earlier Rockwell 4,800-bps modem card sold for less than \$1,000.

AMI, National weigh in with C-MOS RAMs

The market in complementary-MOS memories is getting busier. American Microsystems Inc. **has introduced in prototype quantities a 512-by-1-bit C-MOS RAM**, designated the SS2222. It has a 4-nanowatt-per-bit standby power and access times of 200 nanoseconds typical and 350 ns maximum. Other devices in the works for this year include 1,024-by-1-bit and 256-by-4-bit RAMs with roughly the same performance.

Not far behind will be AMI's Santa Clara, Calif., neighbor, National Semiconductor Corp. with its 74C920, a 256-by-4-bit silicon-gate C-MOS RAM that operates from a 5-volt power supply and has a maximum access time of about 250 ns. Intel and Intersil already are on the market.

Singer shows terminal for Europe EFTS

Hoping to win some much-needed business from a 6,000-terminal funds transfer net to be centered in Europe, Singer Business Machines last week **demonstrated its modified 1502 intelligent terminal.** The unit has been qualified for use by members of the Society for Worldwide Interbank Financial Telecommunications (SWIFT), which presently consists of 260 banks in 13 European countries, the U.S., and Canada. Singer, along with General Automation and Burroughs, have been approved to supply the Swift Interface Devices (SID), which would sell for \$13,000 to \$15,000 each. The Singer 1502 version has the 8,096-bit memory and the 960-character CRT display that are required.

Addenda

Philip R. Thomas has been named Solid State division vice president heading RCA's MOS operation. Thomas, who came to RCA from Fairchild Semiconductor, **will direct all engineering, manufacturing, and marketing activities** for RCA's C-MOS devices, n-MOS memories, silicon on sapphire, and microprocessors. He succeeds Harry Weisberg, who has been named Solid State division vice president for Europe. . . . National Semiconductor is **hopping into the toy market with solid-state game machines**—electronic calculator sets for adults and children, and an electronic roulette wheel. . . . The armed Indians who took over Fairchild's IC plant in Shiprock, N.M., "do not, to our knowledge, include either present or former employees, and do not represent either the Navajo tribal leadership or the Shiprock community," says Fairchild. The occupying Indians say Fairchild has replaced laid-off Indians with whites.

If you could cut your switching loss by 80%, how would you celebrate?

By eliminating a heat sink, maybe? Saving a bit of board space? Improving your circuit's operating characteristics?

Do it with our power darlington. Unlike other darlington, ours offer access to the output transistor base, and have no internal resistors. So they'll give you greater design flexibility, higher temperature stability, and faster switching time.

Because you can vary the bias on the output transistor, you can speed up your switching time or slow it down, give your circuit more gain, less gain, whatever you want.

Using our darlington, you can cut heat loss to one-third or one-fifth, and cut the size of your heat sink proportionately. Most heat dissipation occurs during fall time, so when you speed up

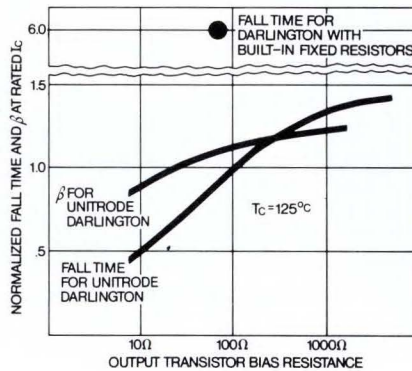

your switching time, you automatically reduce dissipation. And thanks to external resistors, our darlington are much less sensitive to temperature than ordinary darlington.

Send for our free designer's guide. It's the industry's only reference document on darlington, and it'll tell you all about them — what they are, how they work, where to use them. And it includes a dozen application examples for our special darlington.

To get your copy, just circle our number on the reader service card.

Our darlington are available in currents up to 10A and voltages up to 400V.

Unitrode Corporation,
580 Pleasant Street,
Watertown, Mass.
02172.

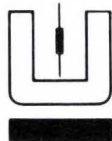
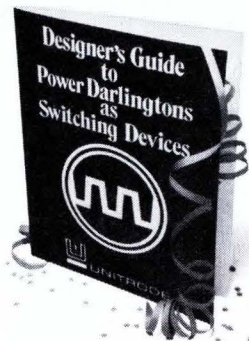

UNITRODE

Meet the Unbelievable Datagraph



Introducing Bell & Howell's new Datagraph® Model 5-144. We call it the best four-channel, portable test instrument available.

You'll call it unbelievable.

Datagraph is ideal for checking out and evaluating an unlimited variety of both analog and digital systems, components and circuits.

It'll handle four tests at once, and give you the answers now, in real time.

Datagraph is as easy to use as an oscilloscope, but it'll give you a hard-copy record up to 200 feet long for further study. Its four channels have a wider frequency response, higher accuracy and provide more flexibility than strip-chart recorders.

Like all Bell & Howell products, Datagraph comes backed by more than 35 years of experience in the development of quality, dependable precision instrumentation. To see Datagraph, contact us for a demonstration.

We think we'll make a believer out of you.



BELL & HOWELL

For more information, write the CEC/Instruments Division at 360 Sierra Madre Villa, Pasadena, California 91109 or circle the reader service number below.

Solar cell R&D getting renewed Federal effort

Ten RFPs out this month aim at developing low-cost silicon solar arrays; JPL program manager for ERDA

Part of the Federal Government's accelerated program for developing alternate sources of energy will take a big step forward this month when 10 requests for proposals are sent out for research and development aimed at reducing the cost of generating electricity with silicon solar cells. The RFPs will be sent out by the Jet Propulsion Laboratory (JPL) in Pasadena, Calif., under the direction of the recently-formed Energy Research and Development Administration (ERDA).

Though the value of these initial contracts will be relatively low, industry interest is high. Representatives of more than 100 companies were present for simultaneous briefings last month in Washington and at JPL on what has been named the Low-Cost Silicon Solar Array Project. The companies (see p. 30) were there in anticipation of a five-year effort to develop photovoltaic solar cells as part of an overall solar energy effort that could eventually cost about \$1 billion. This figure comes from a recommendation last fall by the National Science Foundation which had been the lead government agency for solar energy development [*Electronics*, Oct. 31, 1974, p. 54].

"There was some concern that the [NSF] budget and plan might be cut back, but the latest indica-

tions are that it will hold up," says Robert Forney, the director at JPL of the low-cost array program.

The Federal plan aims at reducing the cost of solar cells by funding applications that would increase production volume and, along with improved processing, lower costs. "The technology is well advanced so that it is just a matter of funding projects to achieve our cost objectives," Forney notes.

From a present price of about \$30 per peak watt of energy, silicon arrays will be engineered under the present series of RFPs to cost but \$5 per peak watt. Within a decade, the hope is to bring the price down to 50 cents per peak watt.

A five-task program has been prepared for the initial stage of R&D. As outlined by Forney, the program is divided into the following goals: re-

ducing the cost of silicon material; fabricating large-area silicon sheets; automating the assembly of solar-cell arrays; developing methods for encapsulating solar-cell modules; and developing techniques for large-scale production.

Thus, two of the upcoming RFPs will be issued for developing a specification for a new "solar-cell" grade of silicon. By being able to use silicon with more impurities than can be tolerated by the semiconductor industry, Forney hopes the cost of polycrystalline silicon suitable for solar cells could be dropped to \$10 per kilogram or less. Semiconductor-grade material today costs \$60 per kg.

Five RFPs will call for developing a solar-cell technology geared for mass production. Fabricating the silicon in either ribbons or sheets that would then be ready for encapsulation and assembly are two leading alternatives.

Also receiving special attention in an RFP will be encapsulation methods, and another RFP will offer funds for studying methods of automatically assembling solar cells into electricity-producing arrays. But the effort going the longest way to demonstrating the feasibility of lowering the cost of silicon-cell power will be outlined in an RFP for large-scale production of arrays. Two contractors will receive awards to first develop prototypes and then fabricate arrays that can produce 200 kilowatts. Delivery of the arrays is scheduled for mid-1977.

In the long term, the government wants industry to be producing each year solar-cell arrays

Spotlight. JPL's Robert Forney heads the efforts to make power from photovoltaic cells cheaper.



capable of generating 500 megawatts. By contrast, in the past years during which solar cell arrays have been used on space satellites, a total of only 60 to 80 kw of power has been produced. An important milestone along the way to the 1985 target are 400-kw arrays to be delivered by 1983.

Ten-year plan. The contracts will be awarded in June. ERDA, which will oversee the programs through JPL, assumed command in January of Federal energy R&D, including almost all research that was once under contract with the Atomic Energy Commission and the National Science Foundation. Up to 60 persons at JPL will manage the solar cell contracts under Forney's direction. At ERDA, Donald A. Beattie is the manager for photovoltaics. H. Richard Blieden [*Electronics*, April 4, 1974, p. 99] is his deputy.

Exact funding for these and fu-

ture projects has yet to be determined. The ERDA budget sent to Congress in February had \$57 million earmarked for solar R&D outlays in fiscal year 1976. But there has been Congressional criticism that the Ford Administration's energy R&D funding request is too low, and so additional funds are likely. A 10-year solar R&D project plan will be given to Congress by June. □

Commercial

Applications opening for Wiegand effect

It's been three years since John R. Wiegand, at a press conference in New York, described the unusual properties of "Self-Nucleating Mag-

netic Wire." There followed intensive applications research and, now, with broad patent protection assured, licensing to develop commercial products has begun [*Electronics*, April 10, 1972, p. 41].

The Brooks Instrument division of Emerson Electric Co. has just signed a limited licensing agreement to use the pulse-generator characteristics of the so-called Wiegand-effect wires to develop a meter for clocking the flow of liquids. Such a meter could be used, for example, to measure the amount of oil pumped in or out of an oil delivery truck, an application for which Brooks already builds equipment.

According to Brooks Instrument, Hatfield, Pa., specific hardware design will not begin for at least two or three months. As a result the company is not yet prepared to comment on the market potential of the radically new metering device.

A second licensing agreement has been arranged with another company, which Wiegand declines to name, to use the coding capabilities of Wiegand-effect wires for a keyboard. It means that a small segment of wire and a pair of magnets could replace the switch assembly in a key.

Other product possibilities being seriously evaluated are a pulse generator—up to 1.5 volts—for an automobile ignition, a turnpike-toll token counter, a garage door opener, an electronic door lock, and a credit-card reader. Wiegand has also devised a means of recharging a wristwatch battery with the pulses from his magnetic wires. This battery charge could provide the electronic version of the self-winding watch.

What is the Wiegand effect? The inventor explains: "In essence, it is the unique capability of a ferromagnetic wire that's mechanically stressed to undergo a rapid switching of magnetization direction when subjected to a dc magnetic field." Thus, to prepare the wire, Wiegand first stretches and twists it for a short time. When the stress is released, the wire remains with a stress-hardened outer shell and an inner core

Companies looking for solar-cell business

Not many of the 100 companies that attended briefings last month on the Low-Cost Silicon Solar Array Project have been noted for their efforts in solar cells. This includes Goodyear Aerospace, IBM's Federal Systems division, Hughes Aircraft, Varian Assoc., TRW Systems Group, Lockheed Missiles and Space, Texas Instruments, Motorola's Semiconductor Products division, and Rockwell International's Autonetics Group.

But any hope for new prospects during the recession is a strong magnet. Says one source close to Rockwell: "They want to get their fingers in every energy pie." And an energy working group within the Autonetics division, Anaheim, Calif., has come up with "a number of potentially profitable solar cell ideas.

The companies that have been involved in fabricating solar cells in the past are enthusiastic that increased effort is getting under way, but fearful that not enough money will be spent. At present, \$8 million is earmarked for photovoltaic R&D in fiscal 1975, and \$10 million in fiscal 1976. The ten RFPs being issued may result in as many as 28 contracts worth over \$2 million.

"It will take a lot more money than they're talking about," says Gene Ralph, vice president of research at Heliotek division, Textron, Inc., Sylmar, Calif. But Ralph concedes the program does have a good chance of "getting off in the right direction."

Somewhat skeptical, too, is Joseph Lindmayer, president of Solarex Corp., Rockville, Md., who says a proposed 200-kilowatt solar-cell demonstration is too small. He'd like to see it five times larger "to generate business for solar-array makers and lower their unit costs. They (the government) should also try to involve private industry to take a greater role in the funding," says Lindmayer, developer of the violet cell concept that provided for improved efficiency of cells used in satellites.

On balance, however, most are more enthusiastic than not. "It's the first time the federal government has really identified solar power as a source of energy," observes John McCrystall, marketing manager at Optical Coating Laboratories Inc., El Monte, Calif.

that's "soft" by comparison; the outer shell and the core have different magnetization characteristics.

The unusual part is Weigand's discovery that the ferromagnetic wire, when placed in a magnetic field, will deliver a pulse proportional to the speed of the magnetic switching action, but not related to the speed at which the magnet approaches the wire. This creates a series of pulses which can be sensed by magnets in a read head. And, notes Weigand, "No power is required for the generation of pulses."

Weigand had been working since 1972 with financial support from the Drackett division of Bristol Myers Co. During this time, he has obtained patent protection recognized in 35 countries. And last December, Weigand reached an agreement with Drackett giving him a free hand in finding licensees for the various potential applications of the self-nucleating magnetic wire. Besides the "short wire" uses in pulse-generator applications, there is also the potential for a "long wire" mode as a data recording device. □



Plain fax. A helium-neon laser inside Xerox Corp.'s new two-minute facsimile machine creates images on plain paper, using the company's xerographic process.

ders will be taken in late summer in 11 other cities and in Canada.

Although designed principally as a two-minute system, a three-minute transmission speed is available if higher resolution is required. Four- and six-minute speeds are also provided for compatibility with Xerox's earlier fax models. At the two-minute-per-document speed, the 200's resolution is 77 vertical by 80 horizontal lines with 6,200 picture elements per square inch.

The 200 consists of a scan/print processor mounted on top of a pedestal containing the system's electronics. Each document is scanned by a focused, 7.5-to-8.5-milliwatt helium-neon laser light source supplied by Spectra-Physics Inc. of Mountain View, Calif. An optical system using a galvanometer deflects the laser across the page. Light reflected from the light and dark elements on each page is gathered by a solid-state strip-light receptor and processed electronically for transmission.

Incoming signals are converted to images by modulation of the same laser that's used for scanning. Richard Cole, engineering manager for the 200, says the laser was chosen as a light source because it is cheaper than most other exposure techniques. Conventional four- and six-minute fax machines generally use an incandescent light source that's imaged onto dry, electrostatically charged paper. But cathode-ray tubes and flying-spot scanners are used as well, which also, unlike the

new Xerox unit, require special sensitized paper.

At the moment, only the Associated Press operates a laser-based fax system. Developed at Massachusetts Institute of Technology's Research Laboratory of Electronics, the AP system is replacing the newswire service's wet-paper process to transmit photographs. Also, Litton Industries' Datalog division in Melville, N.Y., has begun developing a portable military facsimile system that will use a laser and digital technology to transmit messages and pictures at high speed on ordinary communications lines.

Other fast fax transceivers such as the Fax 1, produced by Electronic Associates Inc. of West Long Branch, N.J., use a digital encoding technique that skips the white space when "reading" documents, but reproduces the copy in its original form at the receiving end. Similarly, Rapifax Corp.'s Rapifax 100 uses a proprietary scanning and data-compression technique to transmit a document in about 50 seconds.

The 200 will lease for \$195 a month, plus a transaction charge for each document sent or received over the first 300 documents. The purchase price is \$8,500.

"The pricing," says Howard M. Anderson, president of the Yankee Group, a Cambridge, Mass., market-research firm specializing in fax systems, "is low enough to scare other manufacturers and high enough not to cause wholesale defections among customers from the

Xerox facsimile writes on plain paper

With over half of the U.S. facsimile transceiver equipment market, Xerox Corp. is not doing too badly. But it hopes to do even better with its Telecopier 200, a new automated fax system capable of sending a letter-size document in two minutes, or twice as fast as any of its other Telecopier models. Even more significantly, the unit, relying on a helium-neon laser, uses xerographic imaging techniques, enabling it to receive messages on plain, unsensitized paper.

The 200 was developed and will be manufactured at Xerox facilities in the Dallas area. It will be marketed initially in New York and Los Angeles with first installations in May. Robert J. Potter, president of the company's Office Systems division in Rochester, N.Y., says first or-

existing [model] 400.”

Rapifax, meanwhile, apparently in anticipation of the Xerox introduction, has cut the monthly lease price of its Rapifax 100 facsimile transceiver from \$350 to \$285 and plans to introduce an optional interface within the next two months, making its unit compatible with slower fax models. □

Signal processing

LSI chip handles Fourier transforms

Charge-coupled devices offer one way to apply large-scale integrated semiconductors to the task of com-

plex analog-signal processing [*Electronics*, Aug. 8, 1974, p. 91]. But conventional bipolar technologies offer a parallel and less experimental approach to the chore.

At TRW Systems Group Inc., a bipolar LSI arithmetic unit has been built that performs the fast Fourier transformations needed for such applications as secure military communications and radar-signal processing. In effect, the dedicated single-chip device will do the job that now requires a digital computer, which is the same promise that CCD technology offers.

The TRW chip, called Spau for signal processing arithmetic unit, measures 270 by 350 mils and has the equivalent of 13,000 transistors. Two units in a pipeline configuration can perform a 12-bit-by-12-bit,

1,024-point, fast Fourier transformation in only 2.5 milliseconds, claims Barry Dunbridge, laboratory manager for the TRW Microelectronics Center, Redondo Beach, Calif.

“At that speed, a large mini-computer wouldn’t be enough to do the job,” he says. A fast Fourier transform is a mathematical technique often used to analyze a signal waveform to determine its frequency components. This is needed, for example, to differentiate between data signals and masking signals in the secure high-speed satellite-communications work that TRW is doing for the military.

‘Glorified’ But Dunbridge also says the new chip might be useful in voice-processor systems, as well as in other classified applications.

Texas Instruments strikes back at Bowmar, files counterclaim on calculator patent

Texas Instruments has come out swinging in response to Bowmar Instrument Corp.’s recent suit alleging antitrust violations, conversion of trade secrets, and fraudulent patent practices [*Electronics*, Dec. 12, 1974, p. 38].

TI essentially has denied to the court every significant allegation made by Bowmar. And in a separate, strongly worded counterclaim filed with the Federal court in Fort Wayne, Ind., TI disclosed that on Dec. 2, 1974—the day before Bowmar filed its suit—TI asked the U. S. Patent Office to declare an “interference” between its pending patent application for a “one chip” calculator and Bowmar’s patent [No. 3,781,852] for a single-chip calculator, which, says TI, incorporate the TI “one chip” design.

According to TI, its “one chip” embodies on a single MOS LSI chip all of the memory and logic circuitry required for a four-function electronic calculator with an eight-digit display. An inventive feature of the TI “one chip” is its use of the same set of signals to scan the keyboard and multiplex the display. This eliminates the need for a separate key-

board encoder and drastically reduces the number of connections between the chip and the rest of the calculator.

According to its counterclaim, TI on July 19, 1971, filed an application for a patent disclosing its “one chip” and claiming that, in combination with a suitable key-

board and display, the chip formed a complete calculator. Then on May 24, 1972, TI claims that Bowmar filed an application for a patent on a light-emitting-diode calculator, incorporating the TI “one chip” plus additional interfacing circuitry between the chip and the LED display. This was more than 10 months after

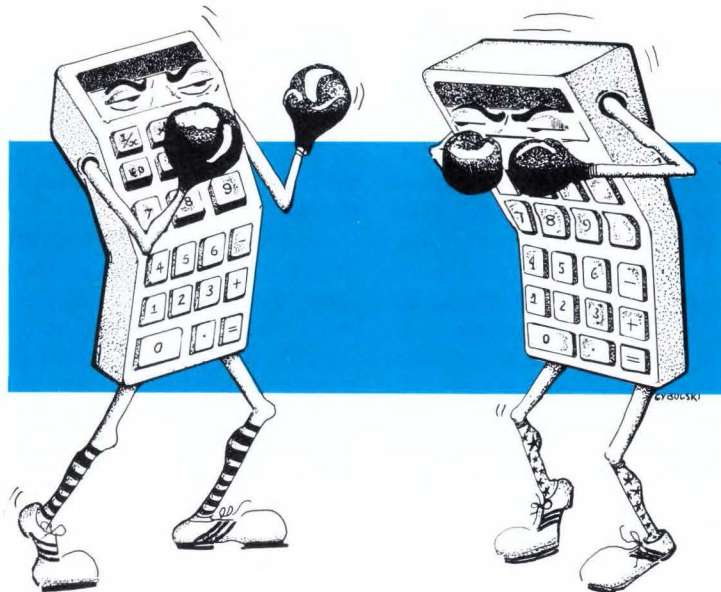

The basic chip, which Dunbridge describes as a "glorified multiplier," accepts two 12-bit parallel data words. And, together with a few, less complex LSI chips that include address-control logic and shift-register memory, the unit performs the so-called "butterfly" or FFT kernel operation, the heart of a fast Fourier transform.

On the chip itself are a 12-bit multiplier, two adders, seven storage registers, four multiplexers, plus input-output and control circuitry. All fit in a specifically designed 64-pin package.

Triple-diffused emitter-follower circuits are used. This process, which TRW uses for its very-large-scale integrated-circuit work, provides high yields for large chip sizes and medium-speed performance,

notes Dunbridge. Yields are high because the process requires only five masking steps instead of, for example, the eight required for a bipolar process involving transistor-transistor logic. Moreover, the emitter-follower process uses homogeneous, rather than epitaxial material, and needs only a single, rather than multilayer, metalization structure.

The process is not used commercially, but Motorola Semiconductor Products has signed a licensing agreement with TRW for military applications and is using TRW masks to fabricate a minicomputer on a chip.

Much of the funding for the Spau development has come from the Air Force Avionics Laboratory at Wright-Patterson Air Force Base. TRW is now completing mask de-

signs and expects to have parts by the summer. Dunbridge says the Spau may find its way into equipment as early as next year. □

Packaging & Production

Standardized art speeds pc patterns

One of the biggest hangups in printed-circuit-board design and fabrication is the transition from a schematic to a photographically reduced negative of the circuit pattern. Each pad and interconnecting wire must be painstakingly taped in place before the result is finally photographed. For a densely packed two-sided board with plated-through holes, this can take as long as six to eight weeks.

But a new process, called System III, shortens the schematic-to-negative cycle to only one week. The System III, developed by Adcor Electronic Packaging Corp., New York, relies on predrilled boards and Mylar masters of standardized pads for the drilled holes and the contacts that eventually plug into an external connector. This combination takes care of most of the cumbersome pattern-taping; all that remains is for the individual interconnection wires to be taped down.

Adcor relies on three types of 0.062-inch-thick copper-clad glass-epoxy boards, each with a highly accurate matrix of holes for mounting dual in-line packages, discrete semiconductors, and passive components. There is a separate group of holes for the connector contacts. The boards measure 4½ by 6½ inches for 16 to 20 DIPS; 6.10 by 6.60 inches for 25 to 30 DIPS; and 7.35 by 7.00 inches for 35 to 40 DIPS. Each of the boards can have a low-density or high-density connector. For instance, the largest card can have either 100 or 120 connector contacts.

When a schematic of a board is received, Adcor's designers pick the appropriate master—a 2:1 enlargement—and tape in the board's inter-

the filing date of the TI application, and more than a year after TI says it had disclosed detailed specifications of its "one chip" and its use in a calculator in technical brochures furnished its customers. The purpose of the interface circuitry, according to the Bowmar application, was to save power and reduce drain on the batteries. Patent No. 3,755,806 was issued to Bowmar in the name of an employee, James H. Bunting, on Aug. 28, 1973.

But on Nov. 21, 1972, says TI, months after the Dallas-based company's first "Datamath" calculator had appeared on the market, Bowmar also filed a "divisional application" with the U. S. Patent Office, carved out of the then pending Bunting application. This application named Edward A. White, then president of Bowmar, as a "joint inventor" with Bunting and, according to TI, claimed as their joint invention the entire calculator. Particular emphasis was placed on the features provided by the TI "one chip," including the keyboard-scan/display-multiplex feature.

"White and Bunting knew, or should have known," says TI in its counterclaim, "that the TI 'one chip' with its unique keyboard scan-display multiplex feature was the prior invention and development of Texas Instruments personnel and they

made no contribution . . ."

Adds TI: "Bowmar and those applicants falsely represented to the Patent Office that the subject matter of the divisional application was their invention." TI also charges that Bowmar and White and Bunting "withheld from the Patent Office the facts" concerning TI's publication of its "one chip" specifications and application details to the rest of the industry, as well as sales of the "one chip" made by TI to numerous customers, including Bowmar itself. All of this, claims TI, occurred more than a year before Bowmar's earliest filing date.

However, in a document dated Dec. 25, 1973, the U. S. Patent Office, apparently unaware of the possible conflict between the Bowmar application (classified as a "display circuit") and the TI application (classified as a "calculator"), issued Patent No. 3,781,852 to Bowmar. It was based on White's and Bunting's divisional application, according to TI, which concludes in its counterclaim that their conduct "was so lacking in candor, honesty and good faith as to render Patent No. 3,781,852 wholly void and unenforceable."

A Bowmar spokesman says the company expects to respond to the Texas Instruments charges "shortly."

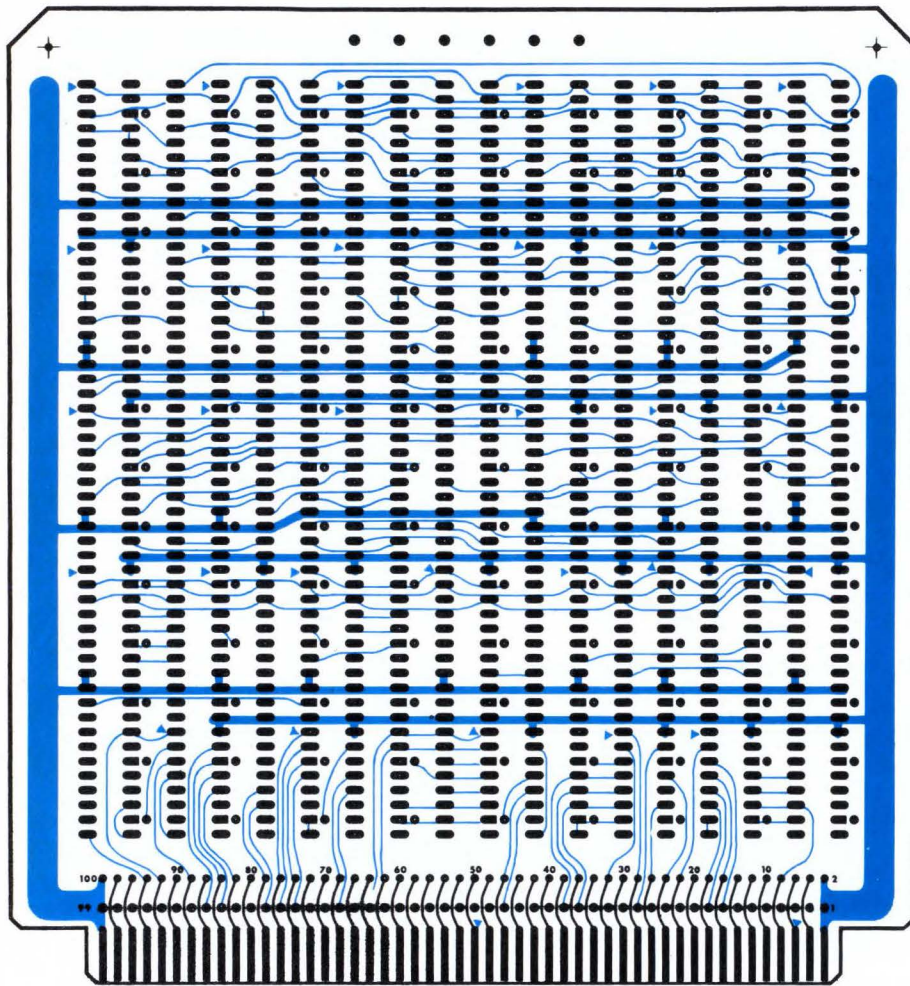

Prepared. Printed-circuit-board artwork developed by Adcor relies on standard matrix of pads. Only interconnection tapes (in color) must be added to produce finished art.

connects. The taped master is then reduced to a correct-size negative that is used to apply an image to the predrilled boards by either screen-printing or dry-film resist.

Adcor president Allen Chertoff says the process already has been used to create negatives for a complex 25-card computing system in one week. Customers using System III have the option of simply buying the finished artwork or buying the artwork plus boards. Artwork alone costs from \$300 to \$525, depending on which type of board is used. In quantities of five to nine, finished pc boards cost from \$55 to \$65 each, but drop to \$10 to \$15 each in quantities of 100.

For customers whose card dimensions and connector styles fall outside of the three basic types, Adcor

supplies drill tapes, artwork, and two samples in 3 weeks for \$650. □

Commercial

Armored cars get digital terminal

That second man in an armored car who rides "shotgun" and keeps an eye on the driver may soon make way for a programable terminal mounted on the dashboard. The first terminals are being installed by Purolator Security, Dallas, a division of Purolator Inc., which operates one of the largest armored-car fleets in the world.

The terminal's basic function is to ensure that the armored car is being

kept to a tight, predetermined schedule, and to radio back to the home office any deviations that could mean that the car is being hijacked. The terminal, developed by Sunrise Electro-Service Corp., Farmingdale, N.Y., is also wired to proximity and motion sensors in the doors, floors and seats. The result is that the system can give an indication of just about anything that could happen to the vehicle that Purolator should know about. The driver can't even hand someone a bag of money without its being recorded in some way; the car's bulletproof windows don't open, and the opening and closing of the vehicle's doors are recorded.

"The system will, for example, sound an alarm if more than one person enters the vehicle," says Sunrise president William C. Smith.

Purolator wants the system to help cut costs by enabling it to use a smaller vehicle with only one driver. The company's bonding and insurance agents have no objection.

Microcomputer. Although unwilling to discuss the system's technical aspects in detail due to Purolator-imposed restrictions, Smith does offer some idea of its capabilities. The terminal uses an 8-bit p-channel metal-oxide-semiconductor microcomputer made by Sunrise from off-the-shelf devices. It continuously monitors the vehicle's route by logging the distance between stops, by timing each stop, which must be made within a prescribed number of minutes, and by polling the sensors in the vehicle.

An odometer, speedometer, clock, and events recorder are built in. The terminal's keyboard has 12 buttons, 10 of which are numbered. The two extra keys are functional but are left blank to confuse any unauthorized attempts to decode the operating procedure. The terminal also has a button with a one-digit light-emitting-diode display that can trigger diagnostic checks of the sensors.

Sunrise went to a custom microcomputer, says Smith, because available products weren't fast enough to decode instruction sets. The Sunrise microcomputer, he

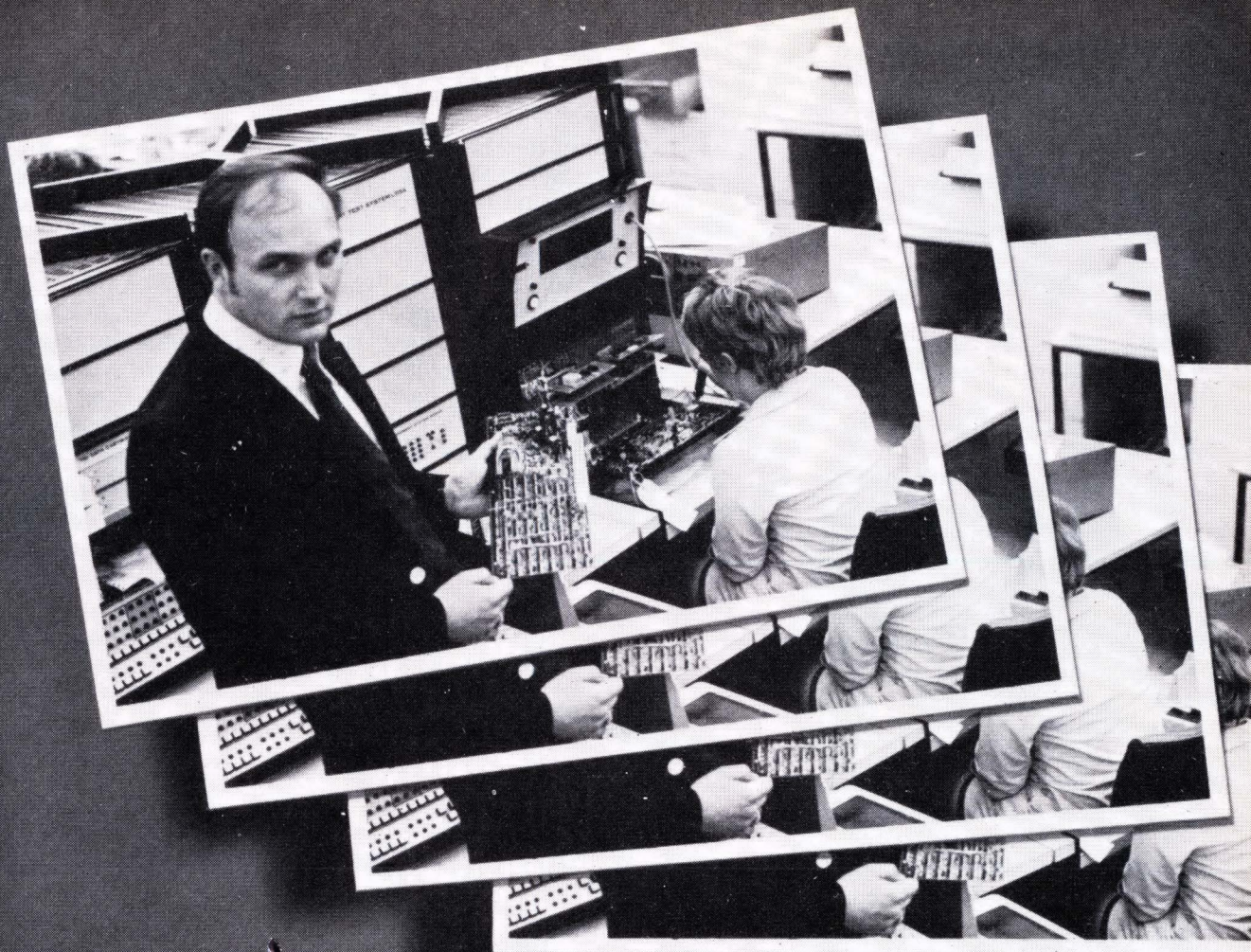

Something from Rank Xerox that's worth repeating.

At Rank Xerox's Welwyn Garden City Plant, the reaction to Teradyne's L100 Circuit Board Test System is unequivocal. Says Alan Wainwright, Manager of Manufacturing Engineering, Electronics: "Our first L100 arrived one month ahead of schedule, and it enabled us to support a product that was very important to us. It was delivered on a Friday afternoon and was testing boards for us by noon Saturday.

"I don't recall ever having received this kind of service before, and it sets a new standard for us to judge others by."

Rank Xerox now has six L100's at Welwyn Garden City, with more on the way. Each system is at the

center of a test-diagnose-repair-retest loop, staffed by technically unskilled personnel. Total test and handling time for a typical defective board is a minute or two, and 75% of the failing boards pass after one trip around the loop. The L100's at Rank Xerox work 24 hours a day, 5½ days a week.

Rank Xerox is far from an isolated case. Well over 100 Teradyne board test systems are now at work throughout the world, and the experience of Rank Xerox is typical of most.

Interested? For full details, write Teradyne, Inc., 183 Essex Street, Boston, Massachusetts 02111. In Europe: Teradyne, Ltd., Clive House, 12 Queens Road, Weybridge, Surrey, England.

TERADYNE

CHICAGO (312) 298-8610/DALLAS (214) 231-5384/NEW ENGLAND (617) 458-1256/NEW YORK (201) 334-9770/SUNNYVALE (408) 732-8770
LONDON (0932) 51431/PARIS 265 72 62/ROME 59 47 62/MUNICH (089) 33 50 61/TOKYO (03) 406-4021

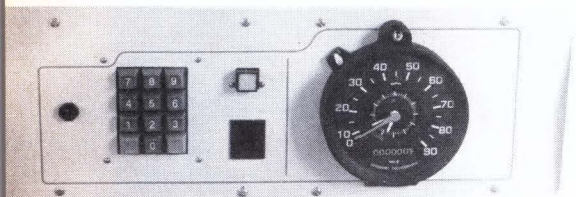

On guard. Armored car terminal includes keyboard, odometer and speedometer.

says, executes one instruction in 2 microseconds.

Before the armored car begins the day's rounds, a supervisor must first arm the terminal with a special key that runs through a four-position lock. This is to deter anyone from activating the terminal by "hot-wiring" its lead connections. The supervisor, using the keyboard, then programs the terminal for that day's events, including distances to be traveled and stops, and gives the driver his schedule. The driver gets into the armored car, closes the door, identifies himself to the microcomputer by keying in his own memorized identification number, and is on his way.

Several audible alarms are built into the truck, including a taped voice which shouts a warning at any intruder. Also, the driver can activate the alarms from a distance with a 100-milliwatt pocket transmitter should he see anyone tampering with the vehicle. According to Smith, the proprietary digital encoding transmission scheme and modem in Sunrise's Moscan terminal, which were originally developed for New York City taxi fleets [*Electronics*, Feb. 7, 1974, p. 39] but not used by them because of its expense [*Electronics*, Feb. 6, p. 8], are being adopted for the Purolator system. □

Automotive electronics

Microprocessor set designed for autos

"The customer doesn't understand electronics and the engineer doesn't understand the application." This

lament is all too frequent when electronics technology is applied to a new function and doesn't work out as well as expected.

But in developing a microprocessor for the auto companies, Rockwell International Corp. hopes to get around such difficulty by providing emulation capabilities that allow the customers to control their own software decisions and to design the large-scale-integrated-circuit system they need.

This approach to an automotive

processor was disclosed for the first time last week at the Automotive Engineering Congress and Exposition in Detroit by Rockwell's Microelectronic Device division, Anaheim, Calif. The microprocessor is a 10-bit, p-channel metal-oxide-semiconductor device that Rockwell supplies with a keyboard-equipped emulator-control module.

The emulator-control uses a combination of random-access and programmable read-only memory. It also has a four-digit display for reading

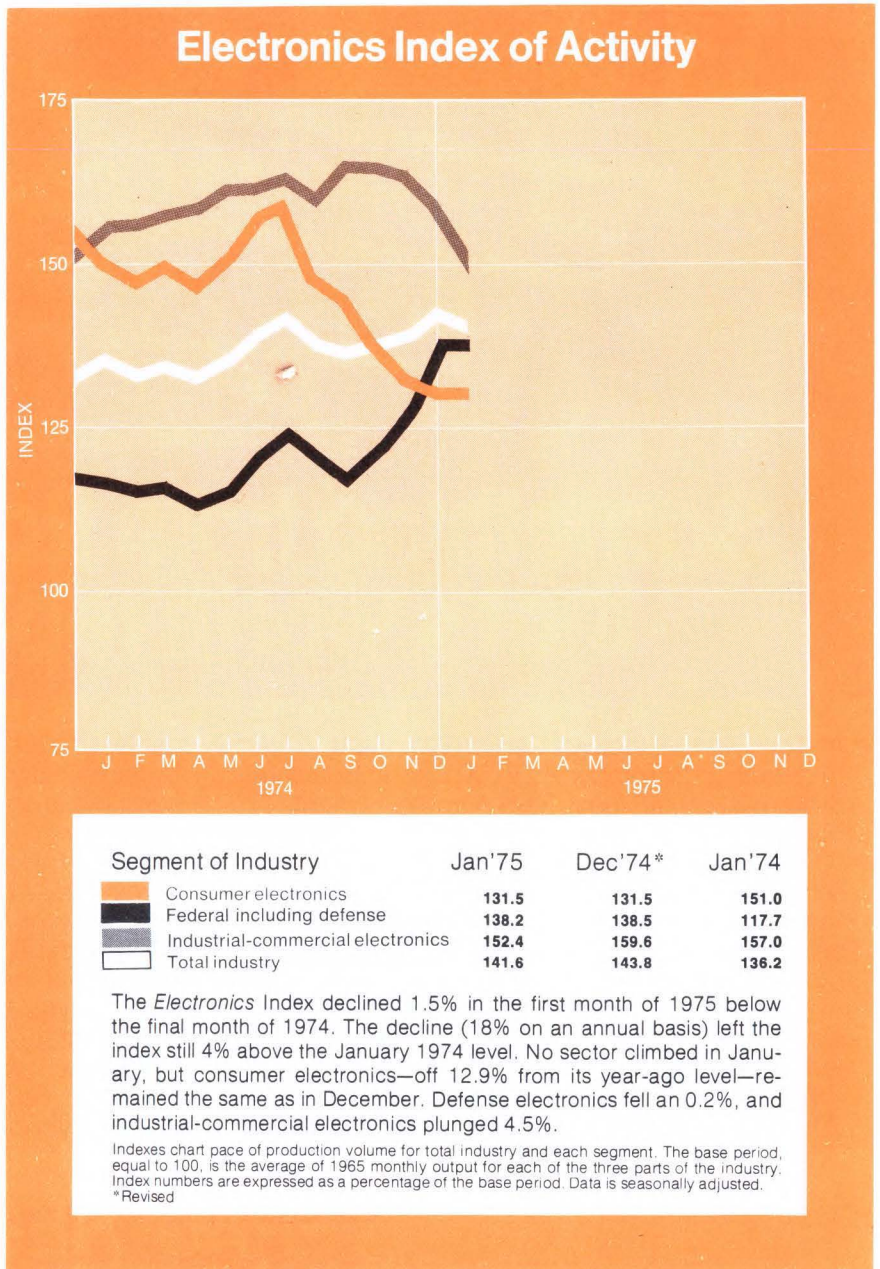

Here are 10 more good reasons to turn to Amperex...

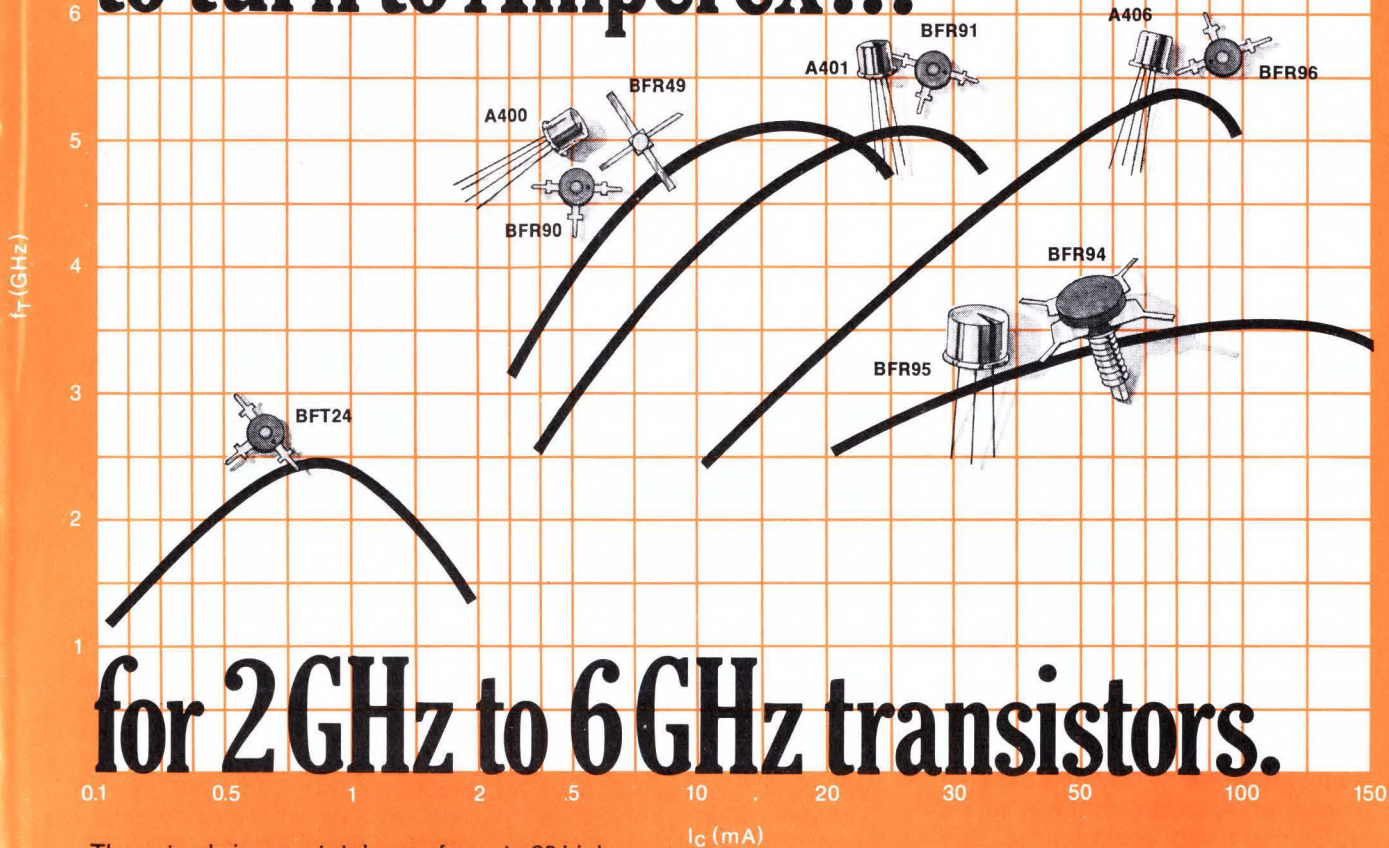

for 2 GHz to 6 GHz transistors.

These ten bring our total... so far... to 23 high-performance, small-signal RF transistors with gain-bandwidth products from 1 to 6 GHz... covering the operating current range from 100 μ A to 150 mA. There's an Amperex GHz transistor to fill virtually any small-signal application up to 2 GHz... CATV/MATV amplifiers, portable pagers and transceivers, high bit-rate communications equipment, frequency counters and high frequency oscilloscopes, to name but a few.

World leadership in shallow diffusion technology and unsurpassed packaging skills come together at Amperex to produce the industry's best combination of GHz transistor specifications, packages and prices.

- Gain-bandwidth products from 1 to 6 GHz at collector currents from 100 μ A to 150 mA
- Noise figures as low as 1.9 dB at 500 MHz
- Low intermodulation and cross-modulation distortion types for wide band and other sophisticated linear applications
- Package-Versatility: plastic Micro-T, ceramic Micro-T, Stud-mounted stripline and JEDEC TO39 and TO72 metal cans
- An entire line priced so low that only two of the 23 devices cost more than \$3.95 in quantities of 1,000... and most are priced between \$2.00 and \$3.00

For further information on the Amperex line of high-performance, GHz-range transistors, write Amperex Electronic Corp., Solid State and Active Devices Div., Slatersville, R. I., 02876, or phone (401) 762-9000.

A GHz Transistor-Line Sampler

TYPE NUMBER	CASE STYLE	f_r (GHz) @	I_c (mA)	PRICE EACH*
BFT24	Plastic Micro-T	2.3	1	\$2.10
A400	TO-72 metal	5.0	14	\$2.38
BFR90†	Plastic Micro-T			\$2.70
A401	TO-72 metal	5.0	30	\$2.62
BFR91	Plastic Micro-T			\$2.95
A406	TO-72 metal	5.0	50	\$3.15
BFR96	Plastic Micro-T			\$3.85
BFR94	Stripline Stud	3.5	100	\$7.25
BFR95	TO-39 Metal			\$3.95

*In 1000 piece quantities

†Also available as type BFR49 in special high-reliability ceramic stripline package. Price each: \$15.25

Amperex®

TOMORROW'S THINKING IN TODAY'S PRODUCTS

Sold through
North American Philips Electronic Component Corporation

Circle 37 on reader service card

out operating parameters of the engine and addresses in the PROMs. This enables operating parameters for control of the vehicle to be changed constantly as field tests are being conducted. The result, according to Rockwell, is that auto-company engineers will be able to determine the exact coding for the ROM that would be designed into a production model of the microprocessor system.

Rockwell's microcomputer, which it calls a programable automotive controller "is organized so that the automotive engineer doesn't need to know MOS/LSI design rules," says H. Andrew Beall, director of industrial electronics for the division, "and so that we don't need to know about engines."

Announcement. Early versions of the microprocessor are in auto companies' hands now, and at least one major auto maker is using the emulator in a development program that Beall expects will be announced shortly. In final form, the system will consist of one chip holding a RAM, input/output and another innovation—an analog-to-digital converter. A second chip will hold a 1,024 by 10-bit control ROM. The system will be able to perform computational and look-up functions for engine and power train applications such as fuel injection and metering, spark timing, diagnostics, cruise control, or automatic transmission control.

The system is not particularly fast, Beall concedes, "but it's fast enough to keep up with the engine." Duty cycle for a typical 300-instruction automotive program runs about 10 to 12 milliseconds. The chip's 70-instruction set includes data curve look-up instructions for solving non-linear control functions by interpolation. Large, flexible I/O sections handle discrete signals, variable frequencies, and digital-pulse inputs and outputs. Seven separate analog input channels accept voltage signals from 1.8 to 5.7 volts. The a-d converter will digitize signals to its 8-bit accuracy in about 10 ms and it is unaffected by normal power supply variations. □

News briefs

National introduces its own under-\$100 watches . . .

After discreetly testing the market for an under-\$100 electronic watch [*Electronics*, Feb. 20, p. 25] by using several watch shows to try out privately labeled timepieces containing its \$25 modules, National Semiconductor Corp., Santa Clara, Calif., has decided to jump into the mass consumer market all the way (see p. 14 for related story). Under the brand name "Exelar," it has introduced four digital wristwatches with retail prices ranging from about \$65 to \$85. In addition, Novus, National's Consumer Products division, has reduced prices on its Timeline electronic watch line sold through jewelry retailers and wholesalers at prices ranging from \$120 through \$220 down to \$80 through \$160. It has also added three new models to its current line of six watches.

. . . as Fairchild enters watch-module business

Fairchild Camera & Instrument Corp., Mountain View, Calif., has entered the digital-watch-module business with a five-function module designated the F-1000. It will use Fairchild LEDs and digit segment drivers. Some of the circuits will be produced internally, and others will be purchased from firms such as Exetron of Santa Clara, Calif., and Frontier Electronics of Costa Mesa, Calif. Initially the company plans to assemble only watches to be sold under private labels.

TI names Bucy to additional post

Texas Instruments' board of directors has given additional responsibility to executive vice-president J. Fred Bucy, naming him chief operating officer (see related story p. 64). He is the first to hold that post since the early 1960s, when TI president and chief executive Mark Shepherd Jr. held both titles. Reporting to Bucy are A. Ray McCord and Edward O. Vetter, executive vice-presidents, and Joseph D. Zimmerman, C. M. Chang, and Stewart Carrell, group vice-presidents. Chang, who headed U. S. semiconductor operations, now has worldwide responsibilities. Carrell, formerly head of European semiconductor operations, will take over worldwide consumer operations. Zimmerman continues to manage digital systems, materials, and electrical products.

Computing recorder to use GI microprocessor

Honeywell Inc.'s Process Control division in Fort Washington, Pa., plans to use its new 16-bit CP1600 single-chip microprocessor, developed with General Instrument Corp. [*Electronics*, Feb. 20, p. 25], in its new Datalab, a gas chromatograph computing recorder currently under test and scheduled for introduction later this year. Under the Honeywell/General Instrument joint agreement, GI can market the device only to noncompetitive applications.

Hewlett-Packard to start factory in Brazil

Hewlett-Packard Co. is expanding its operations in Brazil to include manufacturing. Hewlett-Packard Do Brasil Ltda., Sao Paulo, will soon begin manufacturing in a rented 18,000-sq-ft building in Campinas, state of Sao Paulo. Initial products will be calculators and medical electronics equipment for Brazil and other Latin American countries. The Brazilian company, with about 130 employees, also has acquired about 50 acres of land in Campinas as a site for a permanent manufacturing plant.

Guardian readies line of low-profile relays

The Guardian Electric Manufacturing Co. of Chicago, Ill., will shortly announce its series 1475 relays. The devices will have a maximum seated height of 0.437 inch, reflecting the growing move in recent years to low-profile flatpack devices suitable for mounting on pc boards. The series 1475 will include single-pole and double-pole, double-throw versions, with contact ratings of 3 amperes and coil voltages from 5 to 48 V dc.

We stack the cards your way with 4K RAM systems.

Intel's know-how is all the ante you need to win a pot of money by replacing core memory systems with less costly, higher density, faster solid-state systems built with 4096-bit



16K x 18 RAM

RAMs. Our know-how guarantees you price performance and delivery right now.

Our first card, for example, is a custom 16Kx18 system, complete with control logic, that is now used in a popular minicomputer as a replacement add-on for a more costly core memory with only half the storage density. Next is a 16Kx17 system used in a high reliability numerical control system.

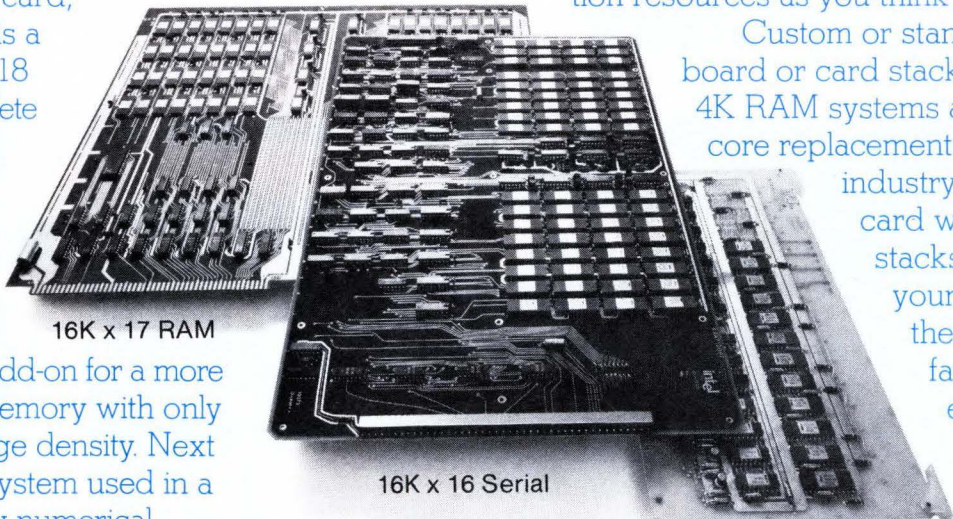

16K x 17 RAM

16K x 16 Serial

4K x 16 Serial

The center card is a custom 16Kx16 serial access RAM memory for a CRT display system. And the fourth operates in another display system as a 4Kx12 to 4Kx16 serial

array. It, too, replaces a bulkier, more costly core memory assembly.

For buyers of standard memory systems, our new ace in the hole is the *in-40*. One 8x10½-inch card stores up to 32 kilobytes in 4K RAMs, in your choice of word lengths, and accesses in only 350 nanoseconds. A universal control card allows expansion at any time to a 256 kilobyte capacity per control card. That stack is only 5 inches wide.

And here's another good deal. When you buy a custom memory system from Intel, you can get manufacturing rights after the initial production run. Use your production resources as you think best.

Custom or standard, single board or card stack, Intel's 4K RAM systems are the best core replacement deal in the industry today. Every card we make stacks the deal in your favor because these systems are far more cost-effective than core in density, performance and price.

Call or write Intel Memory Systems at 1302 North Mathilda, Sunnyvale, California 94086. (408) 734-8102.

Memory Options Unlimited

intel® memory systems

A DIVISION OF INTEL CORPORATION

The Zener Finder's Free

Simplify your zener selection with ITT's free Zener Finder—a selector that displays our entire silicon planar glass zener line, with an easy cross reference to equivalent types.

ITT features a broad line of reliable state-of-the-art planar passivated glass zener diodes, from 250 mW to 1W, in zener voltages from 3.3 to 33 volts.

Now's the time to buy reliability at commercial prices and short lead times.

Our line of discrete components includes rectifiers, silicon switching diodes, germanium diodes, varactor tuner diodes, 4-layer diodes, diode arrays, and transistors.

Specify ITT—write today on your letterhead for your free Zener Finder.

ITT...Logically

ITT PREFERRED TYPES

ITT RECOMMENDED REPLACEMENTS
PART NUMBERS IN1775 — IN3678

ITT RECOMMENDED REPLACEMENTS
PART NUMBERS IN965 — IN1774

ITT
SEMICONDUCTORS WORLDWIDE

semiconductors

ITT Semiconductors is a division of International Telephone and Telegraph Corporation, 500 Broadway, Lawrence, Mass. 08142. Phone 617-688-1881. Factories in West Palm Beach, Florida • Lawrence, Massachusetts • Footscray, England • Colmar, France • Freiburg, Germany • Cascais, Portugal • Taipei, Taiwan • Sydney, Australia

ITT

Landing systems for Army aircraft to await ICAO

The U.S. Army says it will stay out of the market for microwave landing systems (MLS) for its helicopters and transport aircraft until an international standard is reached. This is not expected to happen until mid-1976, when the International Civil Aviation Organization may formally decide between the scanning-beam MLS technique, which is backed by the FAA, and the British-backed doppler MLS technique. The FAA's recommendation of the scanning-beam MLS has been ratified by the Government's interdepartmental executive committee, which includes the Department of Defense. **Unless there is an ICAO decision delay, the Army won't order tactical MLS from its prototype contractor, Cutler-Hammer's AIL division.**

An example of the worldwide interest in MLS was exhibited recently by the Russians, who had a delegation in Washington for two weeks in February looking over the scanning-beam approach.

Costs of software making DOD look hard for cuts

The Defense Department will move this spring to put a lid on soaring computer software costs, now "over \$2 billion annually," or 75% of DOD computer system expenditures. Key recommendations from DOD's Software Management Steering Committee are expected to include **substitution of pre-programmed hardware for software, where possible, and tri-service standardization on compilers and high-order programming languages.** The group is also considering calling for software first in new projects before a commitment to hardware is made.

Building more EDP functions into hardware rather than programming may be possible because of declines in computer costs-per-bit made possible by advances in large-scale integration and other components technologies. While this could boost DOD's initial capital investment in hardware, defense officials say software development and maintenance costs are highly labor-intensive and subject to continuing inflation.

Comsat developing terminal specs for small vessels

Comsat General Corp. is working up specifications for a low-cost terminal for use aboard small ships and offshore oil rigs. These would be used in transmissions with Comsat's maritime satellites, to be launched this summer. **Industry sources say the potential market for such small-ship terminals could eventually soak up some 100,000 units.** This compares with about 7,000 big-ship terminals that are expected to be sold or leased over the next five years.

A Comsat spokesman says each of the stations for big ships now carries a \$52,000 price tag, while prices for the small-ship terminals are still being developed.

Medical advance seen by NASA in cardiograph job

Officials at NASA say an instrument being developed under the agency's auspices **may eventually become a standard medical device that in many applications will replace X-ray equipment.** It is a miniature, ultrasonic scanner that will provide three-dimensional cardiac images. The device is called for as part of the bio-instrumentation aboard the U.S. Spacelab to be launched in the early 1980s, and NASA says it is the only new bio-technical device being planned for the project. Seed money has already been allocated to Stanford University's IC laboratory for the C-MOS-based unit [*Electronics*, Nov. 28, 1974, p. 14].

Currie's defense of R&D

After reading President Ford's proposed budget for fiscal 1976 and its bad news for electronics technology in such applications as law enforcement and health care, electronics companies anxious to support sagging R&D efforts began searching for some good news in the capital. Now they have found it in Malcolm R. Currie's detailed presentation to Congress of the Pentagon's research and development program. And there is far more good news for industry's R&D chiefs in the military's plans than there was bad in the loss of funds for social programs, whose promise and political support were always limited.

As Director of Defense Research and Engineering, Currie wants Congress to give him \$1.569 billion next fiscal year—13% more than he got for fiscal 1975. Of the new total, he proposes to spend some \$384 million for electronics R&D. That money for electronics is not only a record—as is the rest of the DOD budget—but it puts electronics well at the top of the Pentagon's list of the 15 categories of technology it will stress in the year to come.

More than 25%

DDR&E budget specialists point out that electronics will get even more money than the 25% share of DDR&E's money that is represented by the \$384 million. "There is money for things like computers and instrumentation in other categories as well," explains one Currie staffer. These funds can be found buried under such headings as: weapons, materials, aeronautical vehicles, mathematics, physics, and energy conversion. Together these are believed by industry to account for another \$100–150 million.

The principal question that companies are asking is how much of this money will be available to industry. The question is a valid one for contractors troubled by an ailing economy and by DOD's emphasis in recent years on keeping an increasing share of its R&D money for the 47 laboratories operated by the three services. Currie's answer is that industry will get a bigger slice of R&D funds, as will universities, because "a proper balance must be restored and maintained" among the three areas.

After Currie's staff examined the in-house-to-contract ratio for R&D, they concluded that "we have become excessively in-house oriented in the Army in materials and structures, electronics, conventional weapons and research; in the Navy in electronics and conventional weapons; and in the Air Force in research." To counter this, DDR&E proposes to cut in-house

lab personnel by 3,000, or about 5%, in the coming year. The funds saved by these cutbacks, Currie says, "are to be applied to new starts in the contract program."

However, DDR&E is not yet prepared to go beyond this small start toward pushing more R&D to non-Government laboratories. After a year of study, Currie has rejected a plan that would have established a single tri-service contract research program to replace the separate efforts of the Army, Navy, and Air Force. Beyond favoring the need to maintain individual service ties to their own programs, Currie offers multiple arguments in favor of some duplication of effort.

Duplication's bright side

"It is the nature of research," he argues, "that extremely high payoffs are achieved from a small fraction of undertakings. It is extraordinarily difficult to perceive the most effective path to success. Duplication in research programs, therefore, is not bad, and in fact should be encouraged in areas having potentially high payoff."

Perhaps even more appealing to industry, if not the Congress, is the Currie contention that "multiple sources of funding provide insurance against a revolutionary idea being frustrated by the inevitable occasional misjudgments of a single organization." Perhaps more appealing to a Congress reputedly set to cut the Pentagon's programs is the DDR&E chief's economic judgment that "the expense of setting up a new organization or adding to an existing one to manage a single program would offset any consolidation savings for many years."

But if Currie is willing to take the first steps toward restoring the in-house-to-contract R&D balance in favor of industry, he is not anxious to alter the *status quo* of DOD's relationship with its nine not-for-profit Federal Contract Research Centers. The FCRC corporations like Aerospace, Mitre, and Rand, for example, are safe for at least another year, as far as Currie is concerned. Apparently to placate Congress, however, DDR&E has commissioned an internal study of its "relationships" with the nine organizations that will cost the Pentagon some \$266 million this year. Currie says he has directed his deputy "to go deeply into the viability of the basic FCRC concept and to address whether there is and will be a continuing need for the kind of services they provide." It is a study that no one affiliated with an FCRC sees as a serious threat to his job.

—Ray Connolly

NEED A 1/4" x 1-1/4" TIME-DELAY FUSE OR QUICK-ACTING FUSE?

BUSS HAS IT!

Time-current characteristics of FUSETRON® dual-element time-delay fuses

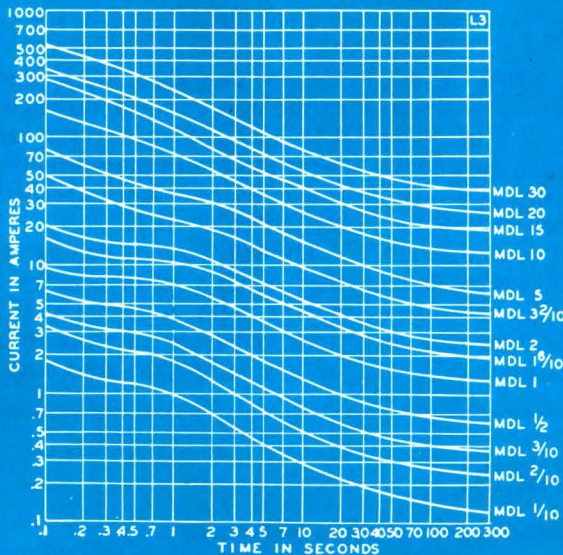

Time-current characteristics of BUSS® fast-acting fuses

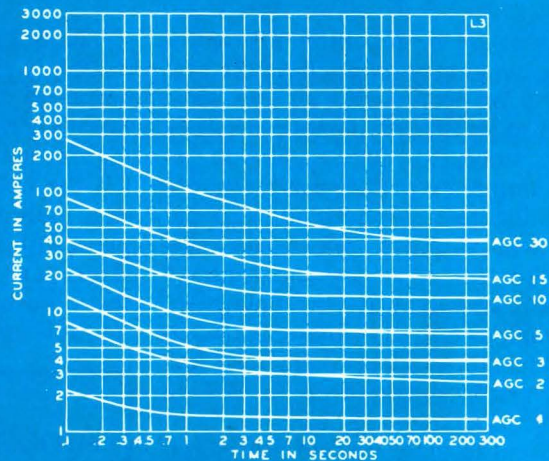

FUSETRON® dual-element fuses

Time-delay characteristics avoid nuisance openings from starting currents or surges—yet, give full protection from short-circuits or dangerous overloads.

Voltage	Symbol	Amperes
250 or less	MDL	1/100, 1/32, 1/16, 1/10, 1/8, 15/100, 175/1000, 3/16, 2/10, 1/4, 3/10, 3/8, 4/10, 1/2, 6/10, 7/10, 3/4, 8/10 or 1
250 or less	MDX	1-1/4, 1-1/2, 1-6/10, 1-8/10 or 2
125 or less	MDL	1-2/10, 1-1/4, 1-1/2, 1-6/10, 2, 2-1/2, or 2-8/10
125 or less	MDX	3, 3-2/10, 4, 5, 6-1/4 or 7
32 or less	MDL	3, 3-2/10, 4, 5, 6-1/4, 8, 10, 15, 20, 25 or 30

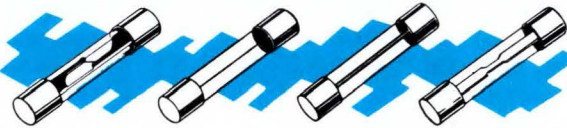

BUSS® fast-acting fuses

Fast-acting characteristics provide the instantaneous high speed opening necessary to protect sensitive instruments or delicate apparatus.

Voltage	Symbol	Amperes
250 or less	AGC	1/500, 1/200, 1/100, 1/32, 1/16, 1/10, 1/8, 15/100, 175/1000, 3/16, 2/10, 1/4, 3/10, 3/8, 45/100, 1/2, 6/10, 3/4, 1, 1-1/4, 1-1/2, 1-6/10, 2
250 or less	MGB	1/16 or 1/8
MBW & MBB fuses now called AGC.		
250 or less	AGC	2-1/2, 3
250 or less	MTH	4, 5 or 6
For 250 volt fuses above 6 amperes—See ABC fuses.		
125 or less	GLH	7, 8 or 10
32 or less	AGC	4, 5, 6, 7, 7-1/2, 8, 10, 15, 20, 25 or 30

For a complete selection of BUSS fuses and fuseholders ask for bulletin SFB.



BUSS In-the-Line Fuseholders

HKP Fuseholder

BUSS Panel Mounted Fuseholders Lamp Indicating

BUSS HGB-C Fuseholder Military Type FHL11U

BUSS Space Saver Panel Mounted Fuseholders

BUSS HMR Shielded Panel Mounted Fuseholders

BUSS Snap-Lock Rear Panel Mounted Fuseholders

BUSS Panel Mounted Fuseholder

Fuse Blocks For 1/4 x 1/4 Inch Fuses No. 4408 2 pole



BUSSMANN MANUFACTURING
a McGraw-Edison Company Division
St. Louis, Missouri 63107



Toshiba to market green monolithic GaP light-emitting-diode display

A pure-green monolithic light-emitting diode may soon relieve the eye-strain of people who till now have had to watch red numeric displays. This summer, Toshiba plans to begin shipments of the pure-green monolithic gallium-phosphide LED numerical displays, which set new records for efficiency and contrast. The price will at first be about twice as high as for red displays, but when production reaches commercial levels, prices should drop to 20% to 30% higher than red LEDs.

Because these devices are monolithic, small size is needed to keep costs at a reasonable level. Toshiba will initially produce two types—one 1 millimeter high, and the other 1.7 mm high. By means of fisheye lenses, these can be magnified 2 to 2.5 times. Initial applications will include camera viewfinders, test equipment, wristwatches, and optical instruments. Toshiba does not intend to use these displays in calculators, for which even red LEDs are considered too expensive.

Even though they have been desired by many users, green monolithic displays have been unavailable, as prototypes have suffered from a variety of problems that discouraged production.

Viewable. The eye is 30 times as sensitive to the green of the new diodes as it is to red GaP devices at 700 nanometers. By eliminating reflected light transmitted through the substrate, the new display emits pure green light at 554 nanometers. However, light transmitted through the substrate suffers selectively higher attenuation at the shorter wavelengths, which shifts its center to yellowish green at 565 nm.

The new devices have a brightness of 150 foot-lamberts at 1.5 milliamperes per segment—about twice that of previous green devices, says Akinobu Kasami, of Toshiba's research and development center.

The brightness at higher currents is slightly greater than unity—for example, it is 600 ft-L at 5 mA. This linear characteristic continues out to high currents and especially qualifies the LEDs for strobed time-division multiplexing of multidigit displays. Other displays have sublinear saturating characteristics that make them unsuitable for time-division multiplexing. The contrast ratio of

the new devices is 200:1—compared to the 30:1 ratio of earlier devices. The increase in contrast ratio is more important than brightness because lack of contrast makes characters difficult to read.

Control. Toshiba engineers found they could control contrast by reducing light from internal reflections and from ambient absorption by means of light-absorbing layers

Around the world

Soviets' communications show stresses technology

At least 15 U.S. firms will exhibit communications and related electronic equipment at the Svyaz-75 exhibit in Moscow, May 22 to June 5. But that's not nearly as many companies as the Soviets had hoped to attract to its first comprehensive international communications show. A combination of economic hardships and U.S. Government restrictions is keeping home some electronic gear the Soviets openly yearn for, especially airborne-communications components and relays. The Soviets will devote more than 26,000 square feet to exhibiting their own products and information from 15 ministries and departments. In addition to commercial equipment, the 12 exhibit categories include amateur-radio displays and technical literature.

Computers control subways in Cologne, Germany

The complex subway system in Cologne, West Germany, is now being controlled completely by computers. Two model 320 process computers and associated equipment from Siemens AG control the system out of Ebertplatz, the main station. During peak periods, an average of two trains a minute pass through the station, where four subway lines converge. Through cables from trackside radio receivers, the computers receive a code number transmitted by every train approaching the center. This number includes the destination, which the computers use to switch the train along a prescribed route. The numbers also indicate the lengths of the trains so the computers can determine when two trains are short enough to share the same platform at the same time.

TTL solves problems for scale and timer

A London electronics manufacturer is about to introduce two products that use transistor-transistor logic to solve a couple of tough problems. Pan-technical Circuit Designs Ltd. will sell a scale, which quickly extrapolates from weight the number of individual objects placed in bulk on the scale, and a timer for industrial control, which is programable in intervals from 2 seconds to 17 hours. The scale, to sell for \$840, calculates by means of a light shining through a tube to a photodetector how many objects are placed on a tray at one end of a balance beam. The total weight is compared with the weight of a single object on the other tray of the scale. The timer, which will sell for \$44 in 100 quantities, is a printed-circuit board 7 inches square with 128 output contacts on the edge connector. The cycle time is programed by the way these output contacts are interconnected.

of silicon 1 micrometer thick, or less. Since silicon is used only for light absorption, polycrystal or amorphous layers can be applied by any of a number of methods.

In the new devices, a modified mesa etch forms a moat around each segment of the display, but does not cut away the unused portions. The moat needs to be only slightly deeper than the 5- μm p diffusion to isolate the p side of individual segments from the remainder of the device. Silicon is applied to the front and back, except over light-emitting segments and the moat, effectively eliminating most contrast-reducing stray light.

Kasami says that brightness was increased by developing new production methods that reduce costs while increasing efficiency. On an n-type wafer from a single-crystal ingot is grown an n-type liquid epitaxial layer 30 to 50 μm thick. Zinc is then diffused to form a layer about 5 μm thick. These diodes have an efficiency of about 0.1%, which because of the eye's sensitivity to green light, is equivalent to an efficiency of about 3% for GaP red

diodes. Efficiency of the latter can range from 0.04% to 0.1%.

Costs. Although liquid-epitaxial processes generally are costly, Kasami says Toshiba's techniques hold costs to the same range as those for vapor-epitaxial processes. As many chips can be processed at one time as by a vapor process.

Also zinc is diffused to produce the p layer without degrading crystal quality, which would degrade efficiency, and controls have been developed for the concentration of the light-emitting center and the minority carrier lifetime.

Previous diode-fabrication technology has involved a tradeoff between cost and efficiency. Low-cost and low-efficiency devices are produced by depositing an n vapor-epitaxial layer, followed by p diffusion, which yields efficiency of 0.04% to 0.05%. For high efficiency at high cost, an n liquid-epitaxial layer is followed by p liquid-epitaxial layer to give an efficiency from 0.07% to 0.1%. A difficulty in producing double liquid-epitaxial diodes is the need for mesa etch through the thick p layer. □

momentary ring of the door bell indicates that the system is in a live condition. The alarm is sounded by a siren installed outside of the house.

Interruption. The Zettler burglar alarm uses the closed-circuit, steady-current principle of operation. Since a tiny current flows through the lines all the time, any variation or interruption of this current, such as tripping a sensor or clipping the wires, triggers the alarm. Each of the two lines to which the detectors and contacts are connected constitutes one branch of a bridge circuit. When the currents in the bridge become unbalanced, the alarm is sounded until switched off by hand at the central unit.

The system's vibration detectors, intended for safeguarding doors, windows, and glass objects, sense slight vibrations caused by opening a window or door or by moving an object to which the detector is affixed. Vibration causes a small spring-suspended mass in the detector to open a contact and set off the alarm.

Contacts. The magnetic-contact devices, suitable for doors and windows, can also be used to protect free-standing or free-hanging objects like sculptures and pictures. The contacts can be installed in the frames of windows and doors, as well as in floors and walls. Opposite each contact is a magnet that keeps it closed. When the door, window, or other object is moved, the contact opens and sounds the alarm.

To prevent a burglar from disarming the device with a second magnet, two sets of contacts could be used. One would respond to the removal of the original magnet, and the other would sense the burglar's magnet.

Since Watchman operates on 12 V, instead of 6 V, as some other systems do, each of the two lines can accommodate as many as 15 different sensors, although only seven are provided in the kit. The central unit, which contains the battery and controls the system, contains logic circuitry to ensure that all doors and windows are closed. □

West Germany

Inexpensive kit enables home owner to build electronic burglar alarm

To keep up with the alarming increase in the number of holdups and robberies almost everywhere, banks, museums, department stores, and similar institutions are increasing their surveillance staffs and turning to sophisticated burglar-alarm systems. But what about the person who cannot afford expensive security protection?

To him, a German firm is now offering a standard electronic-alarm kit, called Watchman, which contains all the hardware needed to make his home or store a reasonably safe place. The kit, from Munich-based Zettler GmbH, is priced at about \$250.

It contains an electronic control

unit, five magnetic contact devices, two vibration detectors, a lock contact for the front door, a high-volume motor-driven siren, and assorted hardware for installation. Zettler says that anyone handy with tools can connect the system himself. Watchman offers simple handling, high reliability, and foolproof operation, he adds. The siren is audible for 250 yards.

The system operates from either battery or ac line power. If the line power fails, the system's 12-volt, 1.5-ampere-hour rechargeable battery takes over. To arm the system, the front-door key is turned twice. This closes the contacts at the door lock and completes the alarm circuitry. A

Here's why REI can rent you what you want when you want it.

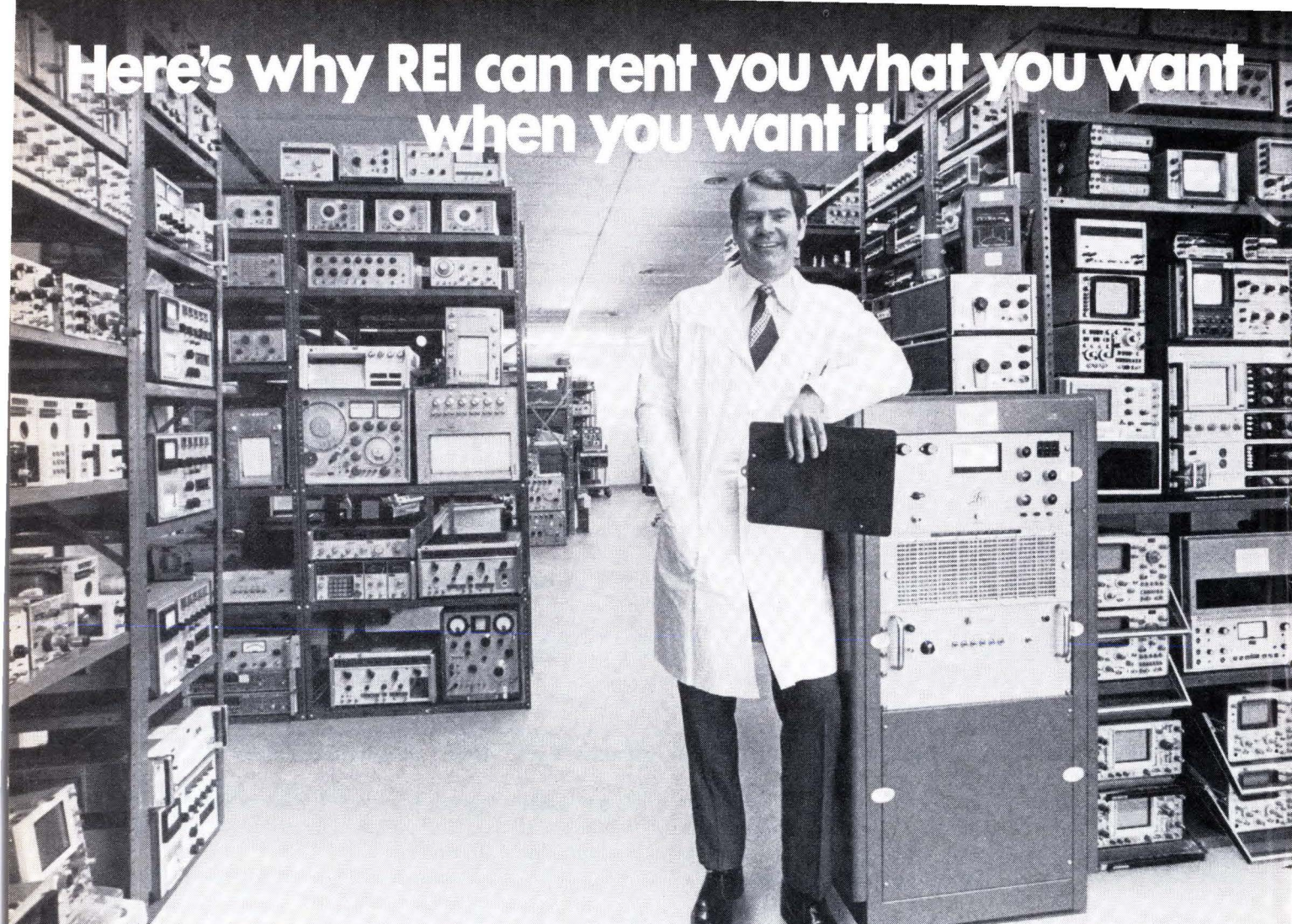

Our inventory. It's the biggest in the industry, with over 8,000 items of electronic test equipment in stock and ready to go. And it's getting better all the time, because we add more state-of-the-art equipment every month. This means we can deliver one special instrument... or a dozen... within hours of the time you place your order.

Now, more than ever, renting makes sense... to stretch your equipment budget, to fill temporary needs, and to avoid the long delivery lead times associated with purchasing. And renting from REI makes even more sense... because we're better equipped to fill your needs than any other rental company.

REI is backed by the tremendous resources of the PepsiCo organization, which gives us the financial strength to keep on hand whatever test equipment you may need. And renting from us helps *your* financial strength,

too. Since you pay only for the time you have your instruments, you'll never have to spend your money on idle equipment.

Send for our catalog today for a description of our rental, rental/purchase and leasing plans, and for our low rental prices. Or call the instant inventory center nearest you for immediate assistance.

Rental Electronics, Inc.,
99 Hartwell Avenue, Lexington, Mass. 02173.
Please send me your free instrument rental catalog:

Name _____ Title _____

Company _____

Address _____

City _____ State _____ Zip _____

Tel. Number _____

Rental Electronics, Inc.

A PEPSICO LEASING COMPANY

Burlington, MA (617) 273-2770 • Gaithersburg, MD (301) 948-0620 • Oakland, NJ (201) 337-3757 • Ft. Lauderdale, FL (305) 771-3500
Des Plaines, IL (312) 827-6670 • Dallas, TX (214) 661-8082 • Mountain View, CA (415) 968-8845 • Anaheim, CA (714) 879-0561
Rexdale, Ontario (PLC Leasing Ltd.) (416) 677-7513

Circle 46 on reader service card

See you at INTERCOM/75 Booth 2631

Production boosts in Japan threaten calculator makers

In what may be the beginning of a shakeout of marginal producers, three Japanese calculator manufacturers are increasing production in an effort to increase their market shares. **They are Casio Computer Co., Sharp Corp., and Omron Tateisi Electronics Co.** The latest company to end calculator production is giant Hitachi Ltd., which, however, remains number-two producer of LSI devices for calculators. Canon Inc. has decided to leave the low-priced personal market to the front-runners and to concentrate on higher-quality units for office use. Other companies are striving for the product mix that will enable them to weather the shakeout, despite higher per-unit costs than the high-volume leaders.

Spain negotiates to produce Fujitsu, Univac computers

Spain's Instituto Nacional de Industria has revived an agreement in principle with Japan's Fujitsu Ltd. for a joint venture to produce small computers. INI is also negotiating with Sperry Univac to produce medium-scale computers. The Fujitsu agreement had been signed before the recent reshuffle in INI that led to the naming of a new president, José María Guerra Zunzunegui.

The agreement has been expanded to include production of terminals and peripheral equipment by Spain's national telephone company, Compañía Telefónica Nacional de España. Spanish interests will dominate the proposed three-way venture to produce small computers, terminals, and peripheral equipment. The Univac pact could also involve Spain's national telephone company in production of medium-scale terminals and peripheral equipment.

Bright two-channel portable scope debuts in France

A two-channel 85-megahertz portable oscilloscope with most of its circuitry packed into 20 integrated circuits has been introduced in France by Schlumberger Instruments. **Sensitivity of the scope nominally ranges from 5 millivolts per division to 5 volts per division, but that can be increased to 1 mV per division at frequencies as high as 15 MHz.** The 21-pound instrument is built around a Thomson CSF Quadripole cathode-ray tube with a screen of 8 by 10 centimeters that's luminous enough to expose film rated at 3,000 ASA. The exact price has not been set yet, but it will be less than \$2,300.

German firm puts British vidicon in tiny industrial-TV camera

What is claimed to be the smallest television camera in the world has been developed for industrial use by a small West German firm, Reten Electronic GmbH of Idstein, near Frankfurt. **Using a vidicon tube from Britain's EMI Ltd., the camera is only 0.75 inch in diameter and about 5.5 in. long.**

The camera, designated RF1830, which will be shown for the first time at the Hanover Fair in mid-April, is intended for inspecting the interior of small cavities, drill holes, and pipes such as those used in nuclear reactors. Responsible for the camera's small size is the EMI vidicon, which is only 0.5 in. in diameter and has no deflection coils. Instead, deflection and focusing are handled by electrostatic means in-

side the tube. Despite its small dimensions, Reten's camera has good resolution—300 lines at the center of the picture. Intensity of the light hitting the vidicon target is only 20 lux, Reten says.

UK vehicle tracker is built around microprocessor

Advances in microprocessor technology may make it possible to track vehicles automatically by radio. Doppler sensors would send signals to an on-board computer, which would calculate the vehicle's position and digitally answer when polled by a transmitter, explain researchers at Marconi Research Laboratories. **Mounted on each side of the vehicle, the doppler sensors would indicate turns, while an odometer-type counter would measure distance.** The microprocessor would compare this data with a map, stored in a cassette, and send digital locations as links for streets and nodes for junctions.

Marconi says the system would work on most land-mobile-radio networks. The concept is almost the opposite of Boeing's Flair [*Electronics*, Feb. 21, 1974, p. 30], which relies on a central computer to interrogate vehicles. Marconi, which has simplified a system for locating London buses, is experimenting with a nondoppler prototype that has an on-board computer.

Microprocessors readied by Hitachi and Toshiba

Japanese manufacturers are continuing to jockey for position in the microprocessor-sales race. Hitachi Ltd. has introduced a two-chip 8-bit microprocessor, and Toshiba has announced an improved version of its 12-bit microprocessor [*Electronics*, March 21, p. 111]. Made by the enhancement depletion p-channel MOS process used for calculators, the Hitachi microprocessor consists of an arithmetic/logic chip and a control chip that contains a microprogram of 128 words by 30 bits plus registers. Cycle time is 2.3 microseconds, and memory capacity is 65 kilobytes. **For an 8-kilobyte memory, system cost is about 20% lower than competitive microprocessors, Hitachi claims.**

Toshiba, which will begin sales of its microprocessor in April, has enhanced its capabilities and put a smaller chip of only 3.9 by 4.6 millimeters in a smaller package. Although the initial price will be slightly higher, the reduced size will eventually result in lower prices than the original version, Toshiba says. In addition to the multiply instruction in the original device, the new one also includes divide and store instructions in the microprogram. Program-execution time was also speeded up by 30%.

TED video-disk system ready for retail in Germany

The long-awaited TED video-disk playback system from Telefunken-Teldec will at last go to market on March 17. **About 1,000 West German radio-television dealers and department stores will retail the system for about \$600**—less than half the price of a videotape recorder, Telefunken says. What's more, TED playback systems compatible with the U.S. and Japanese NTSC television norm and with France's Secam TV standard have been developed.

The TED disks, which offer 10 minutes of color programs, will sell for \$4 and more. The initial repertoire will include 50 titles—entertainment, popular science, education, and children's programs—that come from a number of publishing houses and audio-visual software producers. By year's end, about 350 titles will be available.

EXPERIENCE:

KEMET components entered the electronic age in 1930. Since then, we've grown to be a leading producer of Solid Tantalum, Monolithic Ceramic, and Precision Thin-Film Capacitors.

How we've grown—and the many innovative techniques we employ to maintain the high quality level of our products—are revealed in a new audio-visual presentation.

We'd like to share this tour of our main KEMET manufacturing and administrative complex in Greenville with you. It can be shown in your office, at a time that's convenient for you and your associates.

To make an appointment for your "Visit to Greenville," ask your local KEMET Capacitors representative, or call us. With our experience, we have something to talk about.

Components Department, Union Carbide Corporation, P.O. Box 5928, Greenville, SC 29606; phone: (803) 963-6300, TWX: 810-287-2536, or Telex: 57-0496. **UNION CARBIDE COMPONENTS DEPARTMENT**



KEMET OFFERS YOU MORE.



Compare Multiwire:

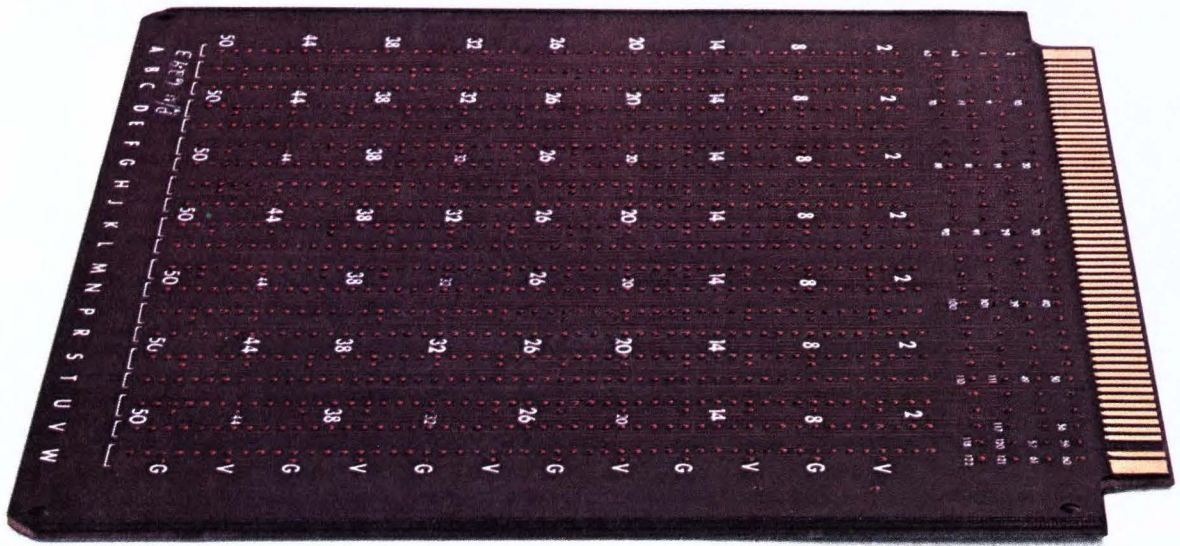

costs less than wirewrapping...

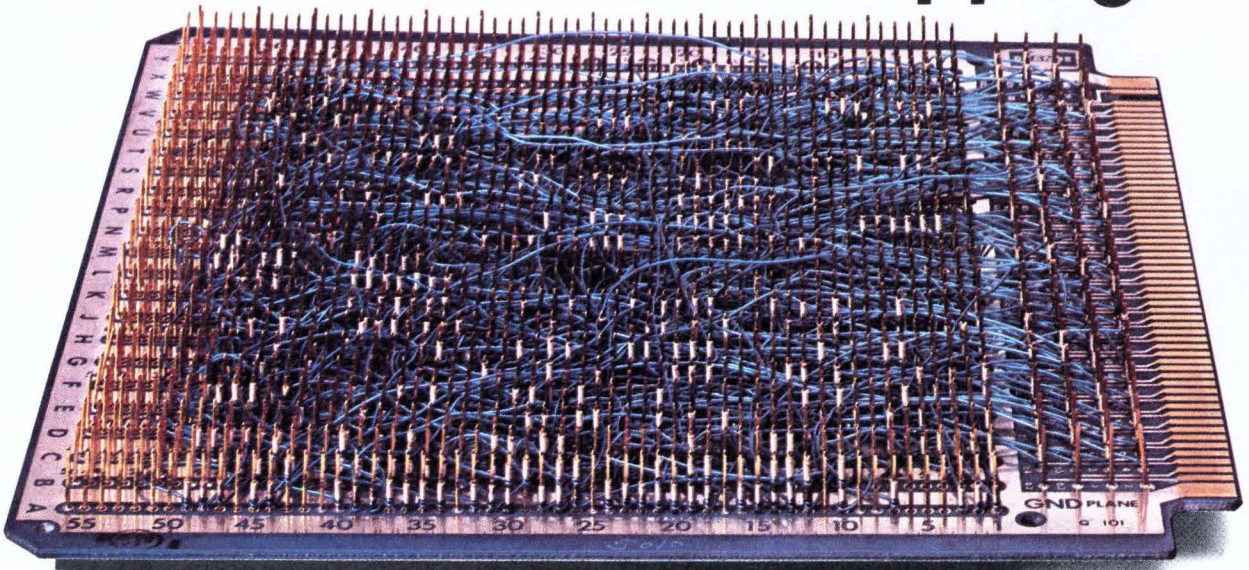

works better than multilayering.

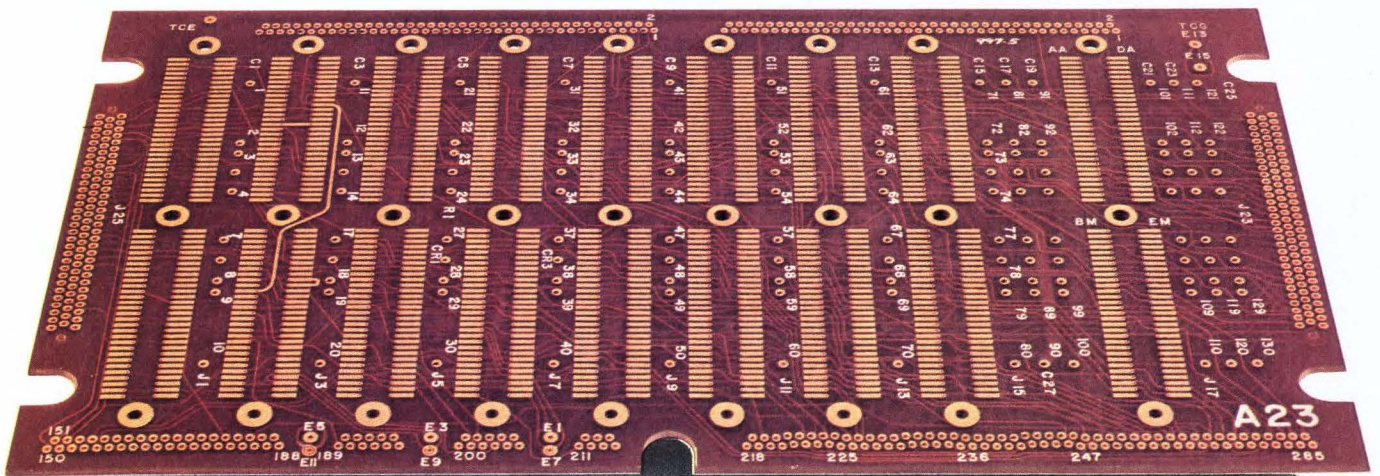

Two major systems—wirewrapping and multilayering—have been used for complex electronic interconnection in the last 15 years. Despite improvements and refinements, each still has inherent disadvantages. That's why Multiwire was created by Photocircuits. It overcomes the disadvantages of wirewrapping and multilayering.

A Multiwire board is basically a customized pattern of insulated wires laid down on an adhesive-coated substrate by a machine operating under numerical control.

Multiwire vs. wirewrapping.

Today, interconnection costs are more important than ever. So take a long, hard look at a key advantage of Multiwire panels. They cost much less than wirewrapping in small or production quantities.

Here's an example of how much less: a Multiwire replacement of a 60 DIP wrapped-wire panel. Total tooling costs were just \$750. In order quantities of 1000 pieces, the Multiwire boards at \$45 each were more than \$30 less than the wrapped-wire panel. (A 40% cost savings.) Multiwire prices also include a 100% continuity check.

But cost is not the only reason for the superiority of Multiwire over wirewrapping. There are also design advantages. For example, Multiwire offers two-dimensional packaging density equal to wirewrapping. But with Multiwire panels, you reduce board-to-board spacing. And Multiwire weighs much less too. So it can contribute substantially toward improving the envelope or three-dimensional package of your product.

Electrically, Multiwire is also superior. The extreme repeatability of the manufacturing process provides much higher electrical reliability as received—this is an important cost-saving factor. In addition, you get the controlled impedance characteristics required without variations.

Multiwire vs. multilayering

With Multiwire, reliability goes up and inspection cost goes down. Multiwire doesn't need extensive inspection—like multilayering does—for nicks, pinholes, hairline cracks, spacing violations and bridging. Yet Multiwire regularly yields better than 99% reliability at incoming inspection.

Compared to multilayering, designing a new Multiwire board is a far simpler operation. Component locations and a wiring list are all we need. Our computer-aided system does the rest.

Since the computer also takes care of deletions and/or additions, engineering changes are simplified. What's more, Multiwire makes it easier to find paths for interconnections, because the insulated wires can cross one another. For these reasons we can deliver finished Multiwire boards to your door in weeks rather than months.

The advantages of Multiwire over wirewrapping and multilayering vary from case to case. We'd like to help you evaluate possible time, cost, design and reliability benefits. For information and price estimates, call the Multiwire Marketing Department at 516-448-1111.

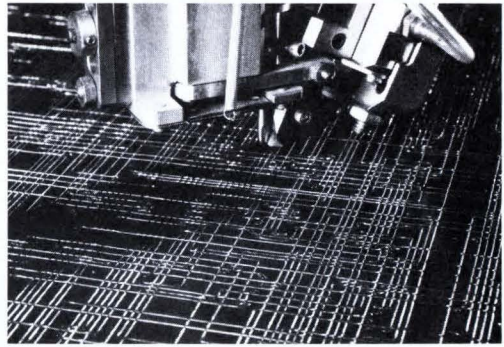
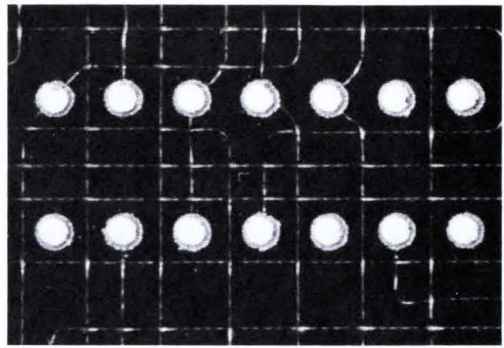

	Wrapped panels	Multi-layers	Multi-wire
Design & tooling cost	Low	Very High	Low
Design & tooling time	Short	Very Long	Short
1st piece delivery	Short to Very Short	Long	Short
Board cost in small quantities	High	High	Medium
Board cost in production quantities	High	Medium	Medium
2 dimensional packaging density	High	High	High
3 dimensional packaging density	Medium	High	High
Weight	High	Low	Low
Ease of changes	Excellent	Poor	Good
High speed electrical characteristics	Fair to Poor	Excellent	Excellent
Interchangeability with other techniques	Fair	Excellent	Excellent
Repairability	Excellent	Poor	Good
Controlled impedance	Poor	Good	Good
Electrical reliability as received	Fair	Good	Excellent

Multiwire from Photocircuits

Division of Kollmorgen Corporation, Glen Cove, New York 11542

Meet the first scope with a microprocessor.

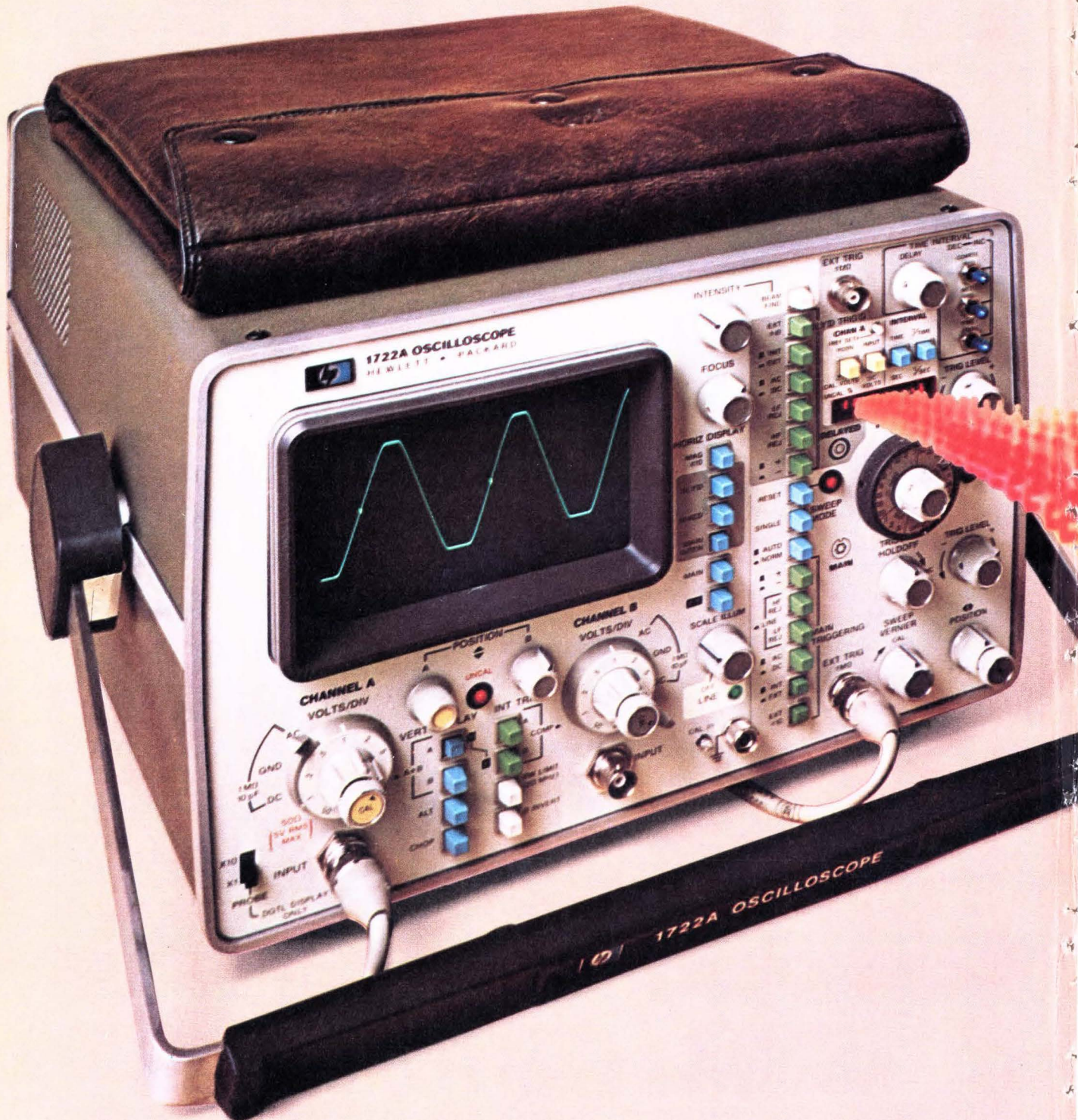

It counts, calculates, and improves accuracy too.

Now, HP has combined a high-performance scope, a microprocessor, and an LED display to put an end to graticule counting, mental calculations, and the conventional 5% scope error. The 1722A gives you a giant leap in measurement accuracy and convenience. It's a working lab partner that speeds measurements of time intervals, frequency, instantaneous or dc voltage levels, and relative amplitude. It allows you to make all these measurements more accurately...with less chance of human error.

The microprocessor takes over several tasks you used to perform. It keeps track of

dial settings, automatically computes time intervals and voltage levels, converts time measurements to frequency, and calculates percent. It even signals if you make an erroneous setting. In addition, the microprocessor drives a 3½-digit LED display to give you a direct digital read-

ing of your measurements...in seconds, hertz, volts, or percent. Working with the 1722A is like having an assistant that takes care of the mental gymnastics.

There's another reason for easier, more accurate measurements—HP's unique Dual Delayed Sweep. It gives you two adjustable intensified markers for displaying the start and stop points of a time interval. The microprocessor then gives you an automatic readout of the time interval between the markers. This speeds digital timing measurements and simplifies the adjustment of circuits to meet a timing spec.

The combination of a proven 275 MHz dual-channel scope, microprocessor, LED display, and Dual Delayed Sweep gives you faster, more complete waveform characterization than you'll get from conventional scopes costing twice as much.

And instead of the conventional 3 to 5 percent reading errors typically associated with voltage and time

measurement's, the 1722A puts you in the 0.5 to 1 percent range.

The 1722A begins a new era of measurement technology by giving you faster answers, more accurate answers, even answers you couldn't get before. And at a price of just \$4,500.*

Let your local HP field engineer introduce you to the new scope generation. Call him today. Or, write for our informative 8-page brochure.

*Domestic USA price only.



For Technical information circle 52 on reader service card.

For Immediate Applications Assistance circle 53 on reader service card.

HEWLETT  PACKARD

Sales and service from 172 offices in 65 countries.
1501 Page Mill Road, Palo Alto, California 94304

08412

**Digital introduces PDP-11/70.
The system all other 11's
have been leading up to.**



Not just fast, completely fast.

The System is here from Digital. It's PDP-11/70 — and it's fast beyond anything of its size or price ever built.

This complete system is designed for speed inside and out. Not just the CPU, but the software, the cache memory, the I/O channels, the disks, the peripherals — the entire package.

The 11/70, with its 32-bit

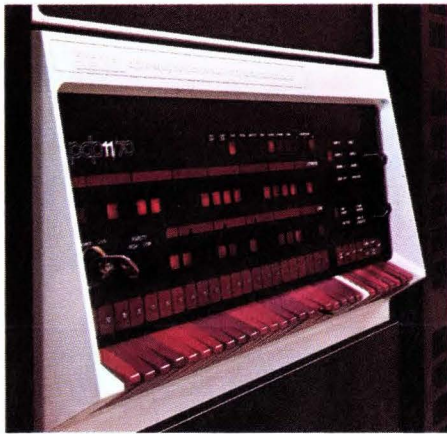

architecture, is a real-time system, a batch system, and a timesharing system simultaneously. And the incredible low price — from under \$100K — means that enormous computer power is about to appear in places it's never been before.

System processor speed.

The heart of the PDP-11/70 is a 300 nanosecond central processor connected to system components by high-speed 32-bit data paths (that perform automatic parity checking on both data and address transfers). And by adding a double-precision floating point processor, you can divide two 64-bit numbers in just 9 microseconds.

System memory speed. The integral memory management unit provides memory relocation, protection, and expansion to 2 million bytes of extremely reli-

able core memory. A standard 2K-byte, 240-nanosecond bipolar cache memory acts like a high-speed buffer between main memory and the processor. The result: an effective memory cycle time under 400 nanoseconds, but at core memory prices.

System peripheral speed.

High-speed peripheral controllers plug directly into the central processor using high-speed 32-bit data paths for fast data transfer. Disk transfer time, for example, can be as fast as 4 microseconds for 32 bits. Disk capacity, using the high-speed interface, can be expanded to 700 million bytes of on-line storage.



Complete system software.

The PDP-11/70's new multi-function operating system, IAS (Interactive Application System), allows concurrent timesharing, real-time and batch. IAS supports a mix of languages including ANSI-74 COBOL, extended

BASIC, Macro assembler, and a powerful ANSI standard FORTRAN IV-PLUS that's



designed for the fastest execution time possible.

And for dedicated time-sharing applications the popular RSTS/E system has been enhanced to accommodate 63 simultaneous BASIC-PLUS users with concurrent batch COBOL operation. For real-time applications, field-proven RSX-11D provides multiprogrammed real-time operation with concurrent batch in the background.

The System is here from Digital. PDP-11/70. Completely fast. For full details contact your local Digital sales office or send the coupon below to Digital Equipment Corporation, Maynard, Mass. 01754. (617) 897-5111, Ext. 2540. European headquarters: 81 route de l'Aire, 1211 Geneva 26. Tel: 42 79 50. Digital Equipment of Canada Ltd., P.O. Box 11500, Ottawa, Ontario K2H 8K8. (613) 592-5111.

digital

- Please have a Digital sales engineer call on me.
- Please send me literature on the PDP-11/70.

Potential application _____

I am considering a new or replacement system.

Other system(s) now performing on this application _____

Other system(s) in my company or organization _____

Name _____

Department _____ Organization _____

Address _____

City _____ State _____ Zip _____

a great new way to "pick" CHERRYS

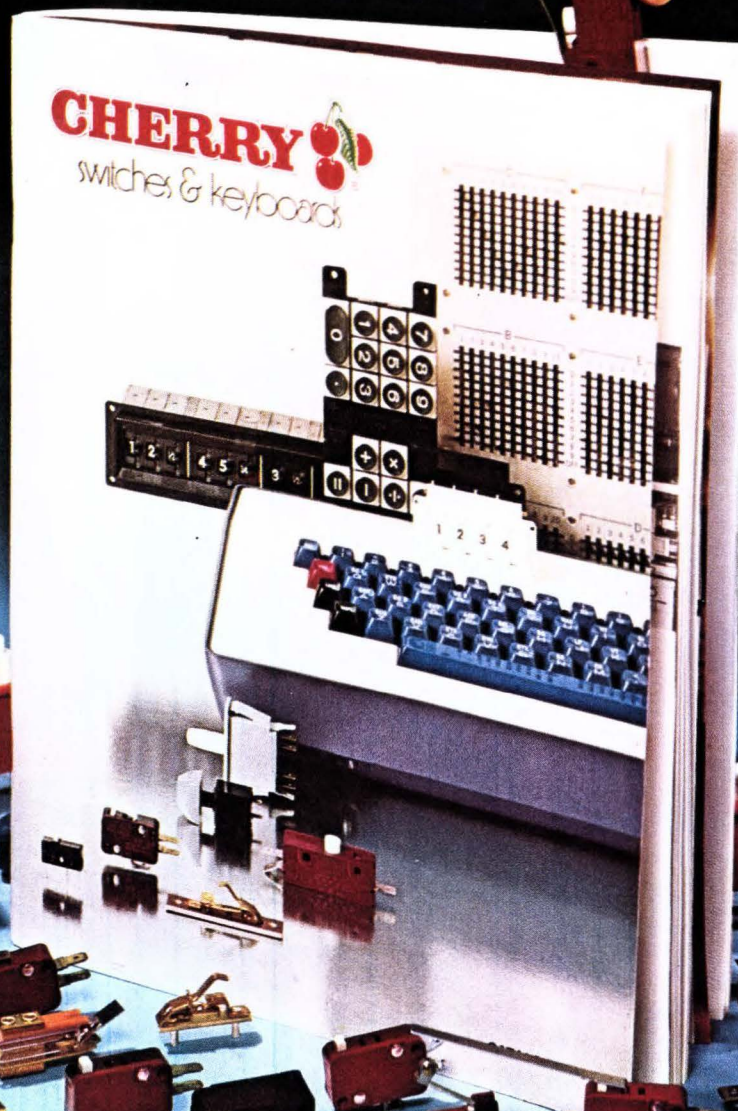

**this new 72-page
Cherry Products Handbook is actually
five catalogs in one.**

Packed in a unique new "tell-all" format is everything you could possibly want to know about Cherry's: 1. **Unique Snap Switch Selector-Locator** that lets you choose—in seconds!—the right switch for any application. 2. **Thumbwheel and Leverwheel Switches** in nine basic series available in hundreds of variations and specials. 3. **Keyboards . . . Keyboard Switches . . .** and unique new **Matrix Keyboards**. 4. **Matrix Selector Switches** for rapid circuit selection and programming. 5. **Gold "Crosspoint" Contact Switches** for low energy circuits.

. . . and it's yours for the asking: Just TWX 910-235-1572 . . .

. . . or PHONE 312-689-7702 and ask for Frank

CHERRY



CHERRY ELECTRICAL PRODUCTS CORP.
3600 Sunset Ave., Waukegan, Ill. 60085



Cherry affiliates worldwide • Hirose Cherry Precision Co., Ltd., Tokyo • G. W. Engineering Pty. Ltd., Sydney
Cherry Electrical Products (U.K.) Ltd., St. Albans, Herts • Cherry Mikroschalter GmbH, Bayreuth, Germany

Circle 56 on reader service card

Probing the news

Analysis of technology and business developments

Bipolar LSI: 10,000 gates in sight

New Schottky integrated-logic designs could make possible 16-bit miniprocessors on a chip for next round of computers

By Laurence Altman, Solid-State Editor

A one-chip 16-bit programable LSI processor operating at the speeds fast enough for today's medium-and large-scale computers? The prospect appeared preposterous a few years ago. But although the ability to put 10,000 gates on one bipolar chip is still some two or three years away, the single-element gate of new forms of logic already makes this kind of performance a hard reality. For example, Schottky integration injection logic has gate propagation delays of 1 to 5 nanoseconds, gate power dissipation in the nanowatt range, and gate sizes of 4 to 5 square mils.

Indeed, the arrival of 10,000-gate bipolar chips is seen as certain by semiconductor and computer laboratories alike. Moreover, bipolar LSI of this complexity will clearly do for computer and high-speed controller design what MOS LSI did for calculator and microprocessor design—it will cause an explosion in the demand for inexpensive but sophis-

ticated data-processing and process-control equipment. So no one is denying that big payoffs await both the semiconductor manufacturers who can build these chips and the computer manufacturers who can quickly capitalize on them.

These 16-bit miniprocessors should not, however, be confused with the 2- and 4-bit-slice Schottky TTL processors now beginning to appear throughout the industry. Useful for many 16-bit minicomputer designs, these processor families nevertheless rely on extensions of conventional TTL and ECL that are likely to peter out at the 750-to-1,000-gate 4-bit-slice level. In the view of many computer logic designers, these first slices offer only limited advantages over conventional MSI and low-level LSI hard-wired logic.

Taking a cue from MOS. Oddly enough, the new LSI got started when bipolar-logic designers began looking at MOS LSI logic that had

been optimized for low power and small size in calculators and microprocessors. "Once we began thinking in terms of LSI concepts, it wasn't that hard to reduce the traditional bipolar gate to a very simple structure," says Horst Berger of IBM Laboratories, Boeblingen, Germany. Berger and Siegfried Weidmann, also of IBM, invented injection logic simultaneously with (but independently of) workers from Philips Central Research Laboratory. It meant getting rid of space- and power-hungry resistive loads, replacing them with an active npn current source, and thus forming a complementary npn-pnp gate structure that fitted into the space of a single transistor.

"The first step," says Weidmann, "was to stop thinking of bipolar design in terms of getting the last drop of speed out of a gate and instead go for a viable low-power LSI design. The next step is getting the process tailored for best perform-

Pure Schottky. The data of an IBM metal transistor with metal collector shows 1-ns propagation delay, right.

Hog. Siemen's current-hogging I²L gate, below, is typical of bipolar LSI aimed at next round of computer design.

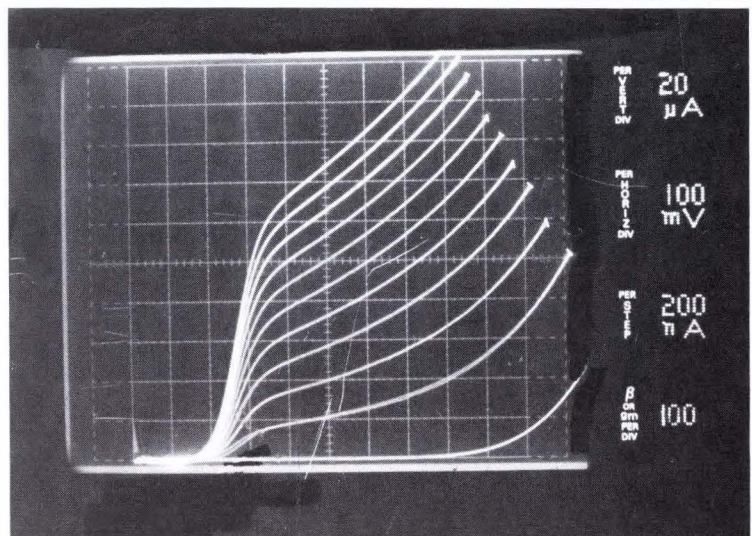
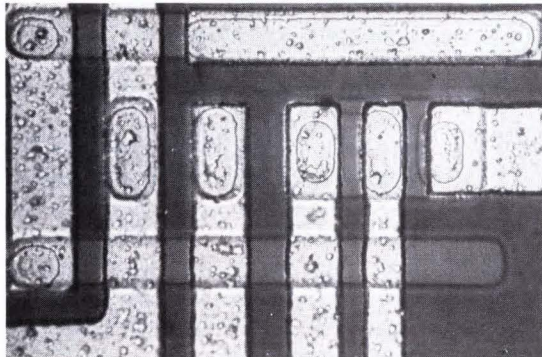

ance—like in the early days of MOS. But we still need to attract the attention of the process technologists, to take our circuit designs and run with them.”

TI's attention apparently has been gotten. Bill Ray, a key member of the design team that worked on TI's first I²L microprocessor, feels that right now the main obstacle to the 10,000-gate bipolar chip is not so much circuit design, but process technology—the yield on big bipolar bars. “At TI we're working at controlling random defects and optimizing process control,” says Ray. “And although we've learned a lot about building big MOS chips for memories and calculators, the bipolar process is tougher because it's got more stops and greater yield risks due to mask defects. It really breaks you, those big bipolar chips.”

Arthur Peltier, developer of Motorola's bipolar C³L, agrees that it's now time for process refinements to enter the picture. He points to the effect ion implantation had on the old emitter-follower logic. “Even with a low-performing logic form like that,” says Peltier, “suddenly you can build 300-by-300-mil chips with defect densities low enough to get reasonable yields. The same techniques can be applied to something like I²L with the same high-

yield, low-defect-density results.”

At Hughes, process refinements are well under way that will optimize bipolar LSI yields. “It's a fact,” says senior scientist James Gaskill, “that the process has come far enough so that we can achieve the required yields. Of course, this means refining our process in a lot of different ways—going to a different dopant for the buried layer to get around conductor losses, or dropping the temperature of the epitaxial growths, maybe even going to silicon masks to ease the alignment problem for production.”

Schottky I²L. The process technologist's new interest in building low-defect bars of complex bipolar chips is further stimulating the circuit designers to better the 20-to-50-ns speeds of their early injection-logic designs. The trick is to get their designs into the 1-to-5-nanosecond range required for computer mainframe controller applications without losing their basic low-power, high-density format. The consensus is that this can be done by adding some form of Schottky output clamping to the basic I²L structure.

Horst Berger supports a two-pronged attack. “First, we're introducing Schottky diodes for reduced logic swings and increased gate speeds. With Schottky we can reduce these swings to the 100-millivolt level, a factor-of-five improvement over straight I²L. Second, we

are trying to merge and super-integrate our devices still further, squeezing out the last bit of speed-limiting capacitances out of the structure.”

TI's Bill Ray points out that along with an improved low-loss Schottky LSI design is needed a good two-level metal system. Agreeing is Siegfried Weidmann: “My feeling is that ultimately we will have two layers of metal at least in the bipolar LSI area, otherwise we cannot fully utilize the inherently high transconductance of bipolar transistors. With long high-capacitance single-metal lines you lose all your advantage.”

The real world. Although circuit designers often get carried away by the significance of their own projects, one design manager, Leslie Vadasz of Intel Corp., is staying in the real world of technology alternatives. According to Vadasz, technologists may not yet be pushing the new LSI circuit designs because an application niche has not yet been clearly defined. “A technology as complex as bipolar LSI will probably start out as a custom solution to an expensive problem—that is already happening in bipolar work for the military—and then if the designs can be optimized and yields increased the system designer can begin thinking about chip partitions for general applications.” This will bring the technology into the standard-product realm. But certainly, warns Vadasz, this is a very complex business. “So far, practically the only place that general LSI logic circuits have become standard is in the microprocessor area now being served by n-channel devices. These are themselves becoming faster each year, and, as they do, they'll cut into the niche that bipolar LSI might occupy. And let's face it—we know how to build good and inexpensive MOS circuits.

“But in the end,” continues Vadasz, “I think bipolar LSI will play on the interface weakness of MOS—MOS devices lack the drive capability to handle most computer interface conditions. You may get the speed up on an MOS chip but you lose most of it at the interface. That's the real work and bipolar can handle it.” □

MOS vs. bipolar?

There is little doubt that the momentum of MOS LSI has shifted to bipolar design for high-performing LSI products. However, Marcel Hoff, applications specialist at Intel Corp., points out that when people make the statement that MOS is not a high-performing technology they probably are not keeping up with new developments.

“MOS performance,” says Hoff, “is getting very close to bipolar, especially in memory, where n-channel MOS is leading the way for very dense 4,096-bit memories offering less than 100 ns access and 500 milliwatts power dissipation. This MOS capability is on the mind of managers who must decide where to put high-technology investments: in further performance improvements for MOS, where they are assured of a low-cost, low-power technology, or into the more risky bipolar area.”

Another voice is that of H.H. Ruechardt of Siemens AG, who is responsible for technology choices there. “The design concepts in MOS are now well defined, so that achieving very high performance will probably require a materials breakthrough, like SOS, which will mean considerable investment in new processing. In bipolar, on the other hand, designs are achieved with conventional processing. The designer tries to gain something out of the still undiscovered magic of junction engineering. This is exciting and may well be very rewarding.”

MOS/FET, bipolar and CMOS on the same chip...

The RCA CA3130 is ready to meet MIL-38510/883.

This highly versatile op amp is now available in High-Rel versions. Just a few months after commercial announcement.

So anyone involved with aerospace, military and critical industrial applications can take advantage of this major breakthrough.

Because of the CMOS output stage, a voltage swing to within 10 millivolts of either rail on a single power supply is now possible for the first time. Other principal features are: high open loop voltage gain: 110dB; low input offset voltage: 8mV; low input current: 5pA; very high input impedance: 1.5 T Ω (1.5x10¹² Ω); high slew rate: 10V/ μ s; 2.5mW at 5V supply voltage; 22mA output.

The speed with which RCA converted this breakthrough technology into a High-Rel device illustrates our commitment to High-Rel Linear

ICs. Further evidence of this is the separate organization devoted exclusively to High-Reliability ICs; by our MIL-M-38510 approved production facility in Findlay, Ohio; by the full Class A, B and C processing to MIL-M-38510 and MIL STD. 883.

For the CA3130 High-Rel 8-page spec sheet, and a High-Reliability IC brochure, call your RCA Solid State distributor. Or RCA.

Write: RCA Solid State, Box 3200, Somerville, New Jersey 08876; Ste. Anne de Bellevue 810, Canada; Sunbury-on-Thames, U.K.; Fuji Bldg., Tokyo, Japan.

RCA



RCA. A full house in Linear ICs.

Electronics abroad

Europeans also await turnaround

Paris Components Show finds suppliers' shelves jammed, and opinions vary as to when the slump will end

by the European editors of Electronics

Ordinarily, the executive suite is the place to get a fix on what's ahead for components markets in Western Europe. But this year, the place to check is the stockroom. From Helsinki to Huelva and from Brest to Berlin, electronic-equipment makers have reacted to the worldwide downturn in business by working off their parts inventories. And until the shelves start looking bare, components suppliers face hard times.

As they head to the annual Paris Components Show in the exhibition halls of Porte de Versailles in early April, marketing executives for the 1,000-odd exhibiting companies will have their antennas tuned for the first signals of a turnaround.

Among the Big Four, France's electronics prospects look best at the moment. Many components marketers, including Philippe Giscard d'Estaing, head of Thomson-CSF's components group, foresee a chance

of a pickup starting in the third or fourth quarter. The country's military equipment and capital electronics producers have solid backlogs of orders.

There's strength in the telecommunications sector, too, although the \$3 billion that the government has earmarked for this year's outlay on its telecommunications nets falls short of what suppliers had hoped for. "The professional-equipment producers destocked in the fourth quarter last year, and their growth means components markets will have to stabilize in the second half," insists Daniel Ameline, in charge of semiconductor marketing for RTC-la Radiotechnique-Compelec, a Philips affiliate that ranks second to Thomson-CSF among French components producers.

The big question marks are computers and consumer electronics. "For computers, 1975 will be a diffi-

cult year; we could have a bad surprise," worries Paul-Roger Sallebert, general director of Fédération Nationale des Industries Electroniques. But some components suppliers insist they've already had the surprise. "We haven't had an order from CII [France's "national" computer company] since November," laments one.

FNIE's Sallebert is less uneasy about consumer products. "It's not all that bad," he says. Last year, FNIE's figures show, French consumers bought 680,000 color-television sets, 18% more than in 1973. Retailers cut inventories considerably, though, and manufacturers' deliveries rose only 7%. This year's consumer sales are expected to rise 15% to slightly fewer than 800,000 sets. Set makers are fairly well convinced that color-TV sales will increase in the second half.

Thomson-CSF's components group figures it could wind up with the same sales total as last year. When inflation is considered, that works out to a decline in real terms. RTC won't put any numbers on its outlook for 1975 until later this month, but it's difficult to imagine how it could fare much better or much better or much worse than Thomson-CSF's components group. Both had about the same sales (roughly \$300 million) and the same sales gain (nearly 20%) last year.

German outlook: up. In West Germany, some products—notably automobiles—seem to be headed out of the slump. But what little optimism there is hasn't reached German components makers yet. They will



On the floor. Persons attending last year's Paris Components Show were enjoying prosperity. This year, they will be wondering when the floor of the recession will be reached.



From seconds to hours count on CRAMER...



...no one else does it better

As the manufacturer with the largest line of elapsed time indicators, Cramer offers you a wide range of standard indicators to choose from for most any application . . . Industrial/Commercial . . . Laboratory/Production . . . or Military. All are available through a nationwide network of Cramer distributors in every NEMA approved size and shape . . . for hours, minutes, seconds and tenths in all ranges . . . competitively priced in all quantities.

But if your special OEM requirements dictate an elapsed time indicator with an odd shape, unusual time registration, unique wheel coloring or some special index, then Cramer can help you there, too.

Send for our new Elapsed Time Indicator Selection Guide that makes ETI selection easy. Remember . . . you can count on Cramer.

CONRAC = Engineered ^{OEM} Products.

CRAMER ELAPSED TIME INDICATORS

CONRAC
CORPORATION

CRAMER DIVISION

Mill Rock Road, Old Saybrook, Connecticut 06475 • (203) 388-3574 — Telex 966-453

Circle 61 on reader service card

Probing the news

probably maintain their grim look until at least the fourth quarter. "Neither the Paris Components Show nor the Hanover Fair will significantly spur business," says Gerhard Liebscher, marketing service manager at Intermetall GmbH, the German member of the ITT Semiconductor Group.

Although there are many bleak spots, a few bright ones stand out. Liebscher forecasts a 30% rise in pocket-calculator production this year, and that will help MOS sales. MOS devices will get another lift from remote-control units for color-TV sets. Although whether set output will climb or fall is a moot question, the number of remotely controlled sets is fairly sure to be increased. MOS, in fact, will go a

long way forward offsetting the sluggishness in other semiconductor sectors. One insider says MOS sales in West Germany will spurt 40%.

British prospects: grim. British components men generally have had plenty of opportunity to keep their upper lips stiff during the past year, and the practice will stand them in good stead this year. The market, estimates J.G. Litterick of ITT Components Group Europe, is down between 15% and 20% in order intake, which to him is key indicator of the state of the market. "Inflation might push the figure up even more," Litterick adds.

He expects a pickup to start about midyear, in part because the equipment makers overcorrected their inventories last year. But it's hard to be optimistic, he cautions. "The computer area began with a strong order book, but there are signs of weakening. The consumer area is weak and much more volatile," he adds.

Strong areas are telecommunications, military equipment, and the sector including radar, navigation, broadcast, and control electronics. Prospects for them are good enough for William W. Ried, marketing manager for AEI Semiconductors Ltd., to report that "everything still seems pretty bright. Everyone I talk to seems to be buoyant." AEI makes high-power and microwave devices for communications and industrial equipment, and, as Ried points out, that's "a different kettle of fish from the low-power consumer side."

Italian components makers have to cope with all the problems their northern neighbors face, plus a few special ones of their own. Along with large stocks and a crippled consumer market, they're up against a credit squeeze and import restrictions that force them to deposit in the Bank of Italy 50% of the value of raw materials they bring in.

What's more, a national cash-flow crunch is making even government-owned companies stall on paying their bills. The combination has hit components companies hard. General Instrument Europe, for example, plans to lay off about a third of the 900 workers at its Naples plant, a move the workers have tried to counter by occupying the plant. □

Visual images are fleeting—so, for the record, ... you need pictures. No telling when or how often they can prove invaluable.

That's why so many of your peers are routinely snapping pictures while looking at specimens and samples with Bausch & Lomb's StereoZoom 7 visual-photographic system. The Champ's superb optical system which gives unbeatable visuals will put the images on film right while you're looking. And they will be available as often as you want to refresh your memory, make comparisons, prove points.

There's a choice of most camera formats with the new Integrated Cameras, Series II with optional exposure meter. They're integral, but do not interfere with the optical system and interchange to fit varying needs.

Be ready. Write for our new Stereomicroscope catalog 31-15 and our free demonstration offer.

THE CHAMP

...PICTURE TAKER



BAUSCH & LOMB 

SCIENTIFIC OPTICAL
PRODUCTS DIVISION

62315 Bausch Street, Rochester, N.Y. 14602

StereoZoom, Reg. T.M.
Bausch & Lomb.

THE 5WK4K ROM.

It's the fastest in the business.

While other sources keep you waiting as much as 16 wks, you can have 4K ROM prototypes from us in little over a month.

Our prices are OK 2. If you're in a hurry, you can have parts in five weeks for a slight premium. For a bit less, you can get them in six to eight weeks. And on an eight to ten week schedule, you'll pay less still. Time is money, for you and us.

And we give you more than a choice of timetables. We also have two different 4096-bit static MOS ROMs. Our S5232 gives you mode control to interchange 512 x 8 and 1024 x 4 organizations whenever you need to. With our S3514, we offer a unique choice of the standard 512 x 8, or, if you prefer, we'll program it to 1024 x 4.

Both our ROMs have push-pull

outputs that can be in one of three states: logic one, zero or open. With the programmable chip selects, this allows you to use several ROMs in parallel with no external components.

Product features include:

Static operation: no clocks

High speed: 600 ns typical access time

BUS ORable outputs: three states

Multiple ROM control: four chip selects

Standard supplies: +5V, 0V, -12V

S3514 replaces Fairchild 3514 and Mostek MK2600P

S5232 replaces National MM5232 and Mostek MK2500P

You may wonder how we can produce a 5WK 4K ROM. Simple. All we make is MOS. We don't have bipolar bumping our mask priorities. And we have all the photographic equipment in-house. Being our own supplier, we can call the shots on delivery dates.

If your ROM supplier has been standing you up, make a fast switch to us by calling our sales office near you.

Manhattan Beach CA • (213) 379-2452
Mountain View CA • (415) 969-0610
Altamonte Springs FL • (305) 830-8889
Elk Grove Village IL • (312) 437-6496
Norwood MA • (617) 762-0726
Livonia MI • (313) 478-9339
Minneapolis MN • (612) 546-3354
Monsey NY • (914) 352-5333
Ambler PA • (215) 643-0217
Richardson TX • (214) 231-5721

AMI, 3800 Homestead Road,
Santa Clara
CA 95051.

Phone
(408) 246-0330.

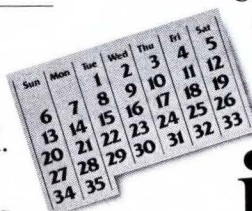

it's
standard
at AMI®
AMERICAN MICROSYSTEMS, INC.



Management

How do you manage in a recession?

For J. Fred Bucy, TI's chief operating officer, the answers lie in productivity, innovation, marketing, and planning

How can a \$1.5 billion company be nursed through inflation, recession, tight money, layoffs, and the other assorted chills and fevers now wracking the world's economies? For J. Fred Bucy, newly named chief operating officer of Texas Instruments Inc., the answer is mainly to increase productivity, introduce new products, seek new markets, and prepare for recovery. The Dallas company has reported a two-thirds increase in sales since 1972, when they totaled \$943 million. The following questions and replies were gleaned from an interview with the editors of *Electronics*:

Q: How do you evaluate the present downturn?

A: I think this is the most severe and disruptive one that we've ever had in the semiconductor industry. However, I think a lot of things are different this time. In earlier years, the electronics industry was such a

small part of the total GNP [gross national product] that, as long as we were finding new applications faster than the GNP was falling, we could still grow. I think the electronics industry is too big for that now.

Q: What kind of timetable do you see for recovery?

A: I think it's going to be very slow. The chances that it will be flat in the last half of the year are probably no better than 50-50 now. It's probably 60-40 that the economy will continue to turn down, and maybe a 20% probability that it will turn up. Most likely, the upturn will not start before early '76.

Q: How fast will we recover?

A: Once the economy starts turning, it's going to turn like crazy. It's really going to snap back in a hurry because everybody's been running so lean.

Q: How do you protect yourself from not being able to supply custom-

ers when an upturn comes?

A: The semiconductor industry hasn't solved that problem very well. That's why we get double and triple orders.

Q: Looking back, was this the primary problem?

A: Sure. Customers were just hedging their bets. They had to do it to get their needed material. Everyone in the semiconductor industry was convinced that their backlog was solid, so they kept building capacity and inventory. Thus, when things turned, they found out they had too much inventory. Also, the distributors were trying to protect themselves by overordering. I think there was a bigger inventory buildup this time in total than in previous booms due to widespread "shortage psychology" for all types of materials, and rapid growth of inflation.

Q: Until midyear, people said they

were looking for double-ordering but not seeing it. Why?

A: Because that information is very tightly guarded by our customers. The guy that can really call that turn will be better off competitively than anyone else. It's no secret that, at TI, we kept a good handle on distributor inventory relative to most of the people in the business. We kept count of what was going on our distributors' shelves, and if our product wasn't turning over a certain number of times, we didn't care whether they ordered it or not, we wouldn't ship it to them. That made a whale of a difference to us as far as excess inventory. On the other hand, when the bottom fell out, some of our competitors started shipping more to the distributors to get it off their plant inventory and off their books.

Q: Even with your strict controls, you've had to fire employees. How do you get into a position like that?

A: Very simple. We held our backlog until October, then we started consuming it rapidly. You have to ship your backlog to meet your customers' demands. If you don't ship on schedule, your customers are going to go to your competition. If your incoming-order rate is at a lower level than your shipping rate, there's a time when you're going to run off a cliff. There's no way to avoid that—you either start cutting back on people and losing business or keep people until you meet your customer needs and then take action. Either way you are faced with hard reality. You have to reduce people. This smashed in very hard on everybody—we saw it coming. We told everybody in our third-quarter report. However, the fourth quarter was more disappointing on incoming orders than anticipated.

Q: Are you saying that there's really not much a company can do and that it's bound to be a costly, difficult situation for all concerned?

A: Oh, it's very expensive for any firm—disruptive to people's careers, to morale, to profits. I think things can be better controlled, but when this is over and we go back and look over history, I think we'll see that the fourth quarter of '74 experienced the most rapid drop in the economy that has been experienced

in many, many years. The economy went sour faster in the fourth quarter than it has since the depression. That's what scared the living hell out of economists in Washington—they thought here was 1929 all over again. It has shaken the confidence of a lot of people. The ultimate thing is to be able to manufacture without people, and I don't think the semiconductor industry is going to reach that point very soon.

Q: What happens when business turns up?

A: The companies that have done the best job of automating, reducing cost, and improving yields during the recession are the ones that are going to be able to recover the fastest because, as yields improve, obviously you are building capacity. If you don't figure it right, even then, you'll go short on capacity, and then we'll have another double-order boom.

Q: Is inflation the biggest problem an executive has to worry about?

A: No, the biggest worry is incoming orders. I think sales entered is what we're concentrating on—we use the term "net sales entered," where most people use bookings. Net sales entered is the net number booked during the month minus cancellations and returns.

Q: Do you make a concentrated effort to improve yields in times like this?

A: You bet.

Q: How do you look at capacity?

A: Well, you don't exactly go out and build additional buildings or machines. You build new kinds of machines—machines that will improve your productivity—your yield—so that when the good times roll again, you'll know that you have updated equipment. That's where the difference is—between those companies having the cash to invest during this mini-depression and those who don't, depending on how well they've managed their assets.

Q: What about new products?

A: The same thing.

Q: Do you make a more aggressive effort to introduce new products, or do you hold back?

A: You should be more aggressive. During slow times, employ your people to make new products

because they're not consumed with the every-day crush of business of getting the product out. These hard times are opportunities for product development and yield improvement. Those who don't manage their business this way are in worse shape when a recession is over. We gained strength during the last downturn, and I think we'll gain strength during this one.

Q: Do you still believe that the growth rate of electronics will average 9% through 1980?

A: That is a reasonable number with moderate inflation, but it's a low number at the rate of inflation today. I think electronics will continue to find additional applications.

Q: Do you mean electronics will move into other areas?

A: Yes. We have opportunities that we haven't done anything about. [TI president] Mark Shepherd [Jr.] is a bug on hi-fi. He recently got a brochure on a new speaker that uses an IC to replace the baffle. That's the sort of imagination we need to use and are using.

Q: You are now selling watch modules. Do you plan to enter the watch business?

A: I think we'll wind up in the watch business. I can't make any projections on it because our policy is not to divulge what our new products are going to be until we bring them to market. The module we are producing is an excellent one.

Q: Why didn't you enter the market?

A: We didn't think the timing was right and believed we ought to be a little more innovative in styling. However, before the electronics industry really bangs the hell out of the watch business, we're going to have to come up with a better display. If we do, we're going to wipe out the mechanical watch.

Q: What kind of display?

A: Well, that's a tough one. We've got some ideas that I can't tell you about.

Q: Are you implying some sort of new technology?

A: Well, it's got to be something that you can see in a dark room as well as in sunshine. Right now, you can't see these LED watches in bright sunshine. We need something innovative in the display. □

Memories

Users starting to go for 4-k RAMs

All plan to design the chips into future systems, but most wait till questions of availability and configuration are clarified

The 4,096-bit random-access memory is steadily edging its way into the consciousness of computer and peripheral-equipment manufacturers. A quick survey of potential users shows that, though only a handful actually are now building the part into equipment, the rest appear unanimous in their acceptance of 4-kilobit memories as a component they are going to have to con-jure with in the near future.

Hewlett-Packard Co. remains the shining example of a user that decided early that the new memories would pay off [*Electronics*, Feb. 20, 1975, p. 30]. Digital Equipment Corp., the Maynard, Mass., mini-computer leader, seems to be not far behind. Brian Croxon, DEC's manager of memory systems, says his company has the parts in two systems: the PDP-11/04 minicomputer and the LSI-11 microcomputer.

There are two obstacles holding back potential users: availability, and pin configuration. Perhaps the tone was set when Texas Instruments Inc. had early yield problems with its 22-pin version, and Hewlett-Packard turned to Mostek Corp.'s 16-pin type. H-P is now back in the TI fold, though it may switch to a denser 18-pin package later. Meanwhile, Mostek has had its own troubles—what president L. J. Sevin refers to as “minor reliability problems in the early production.” Sevin adds that “these have been corrected to all customers' satisfaction. Yields for the MK4096 have also been a problem.

One customer that's sticking with Mostek's 16 pins is Datapoint Corp. of San Antonio, Texas, which uses the part in its model 5500 intelligent terminal. John Walker, operations vice president, says, “We are not using the 16-pin part for density requirements—we use it on the same size pc card as the 22-pin. We're using Mostek because they are a reliable, reputable supplier. They advised us they were having yield problems, and I believe that Mostek is delivering parts to us for less than it costs them to build. They wouldn't be doing that if they weren't close to solving their problems.”

But still the leeriness about 4-k

RAMs persists. John Hunt, vice president and technical director of the Singer Co.'s Business Machines division in San Leandro, Calif., says it will be two or three years before Singer shifts from core. “First,” he says, “there is just no getting around the availability problem. We've looked at almost every 4-k available—TI, Mostek, Motorola, Intel, MIL, AMI, and even a few from National. But the quantities we've received aren't enough to do adequate testing on, much less go into production with. And even if we could get enough today, a particular manufacturer could lose control of his yields and we'd be up a creek.”

Among those holding off until a

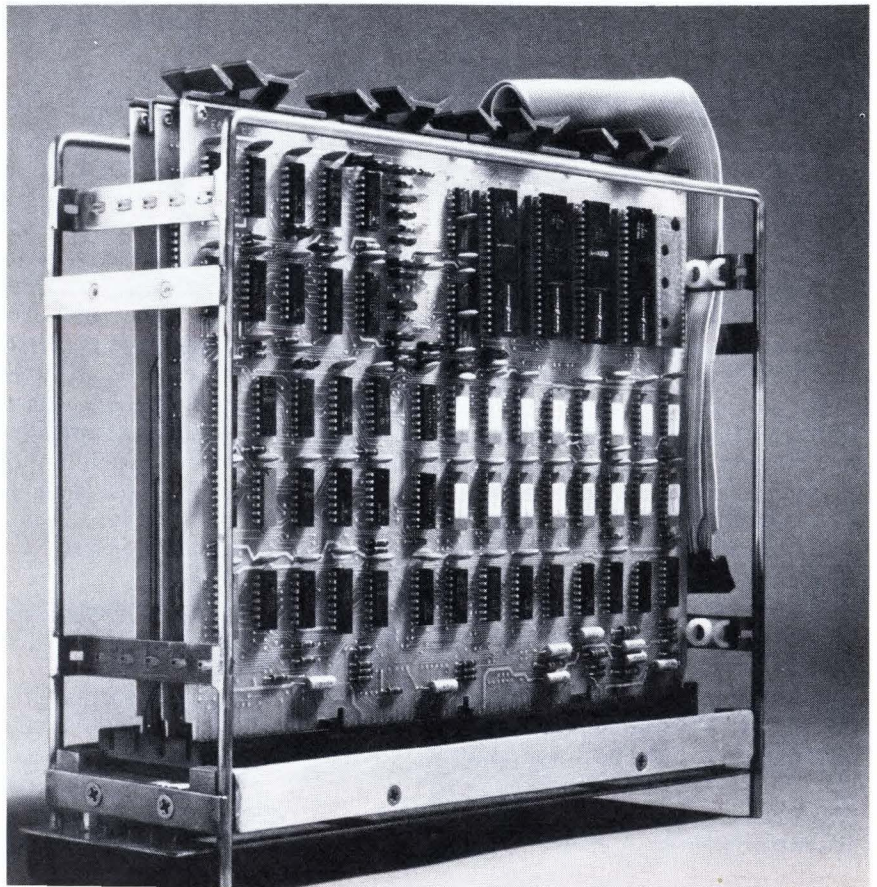

Forerunner. This is Digital Equipment Co.'s LSI-11 modules in backplane. The computer uses 4,096-bit random-access memories

RIGHT ON TARGET AGAIN



A perfect match when things get hot

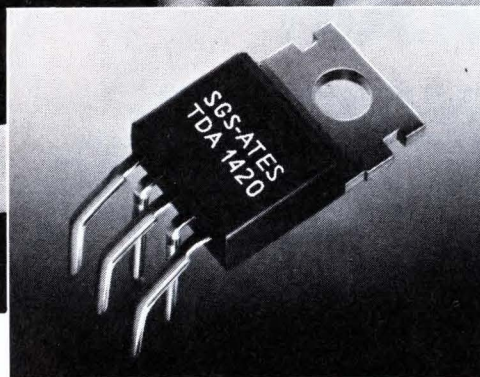

Circle 66 on reader service card

1 st monolithic complementary darlington pair

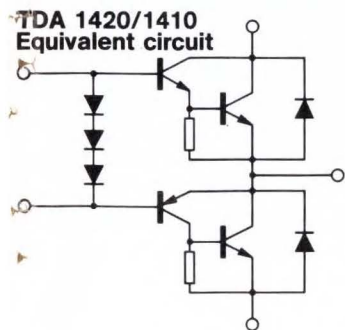

The TDA 1420 integrates a quasi-complementary (NPN/PNP) darlington pair and biasing diodes for perfect electrothermal matching. Applications for this versatile power IC include DC or stepping motor drivers, op amp power boosters, audio output stages, etc.

All this in Pentawatt®, the rugged 5-pin plastic pack.

For lower voltages try the TDA 1410.

Key parameters	TDA 1420	TDA 1410
V_{CE0}	44 V	36 V
V_{CES}	60 V	50 V
I_C	3 A	3 A
$P_{tot} @ T_c \leq 60^\circ C$	30 W	30 W

THE WORLD'S FIRST CIRCULAR IMAGE SENSOR.

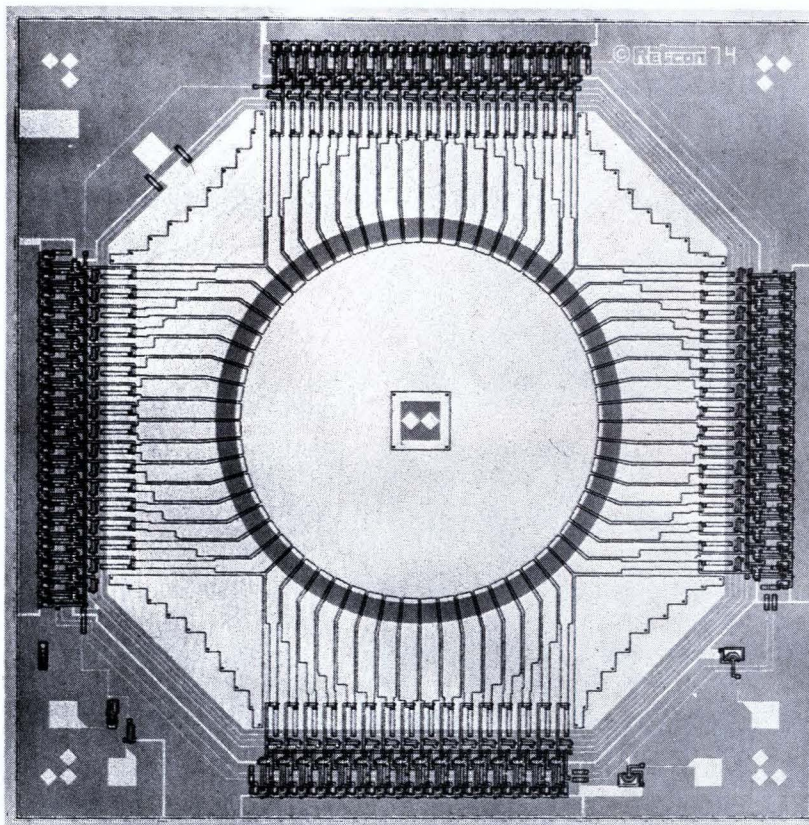

CIRCULAR?

YES. And with on-chip scanning to provide serial output on a single pin. The 64 sensors of the R0-64 are each 0.1 mm x 0.1 mm in size and are uniformly spaced on a 2 mm diameter circle. The array can be operated at scan rates as low as 30 scans per second or as high as 40,000 scans per second. The device is packaged in a 16 lead ceramic DIP and sealed with an optical quality quartz window. The R0-64 is designed for applications in tracking, automatic alignment, automatic focusing, pattern recognition and many others.

RETICON also continues to offer the most complete line of standard linear and matrix arrays in the industry. Our "C" series linear arrays provide from 128 through 1024 elements of resolution on a single monolithic chip and are considered the standard in facsimile, OCR, and industrial control applications.

Custom devices have been developed for a wide variety of applications from point-of-sale to spectroscopy.

In solid state image sensing, our technical leadership backed by over 60 salesmen and 14 distributors over the world makes RETICON the most viable source.

RETICON®

910 BENICIA AVENUE • SUNNYVALE, CA 94086
PHONE: (408) 738-4266 • TWX: 910-339-9343

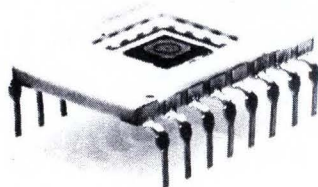

Probing the news

consensus emerges on pin configuration is General Automation Inc., the Anaheim, Calif., minicomputer maker. At Varian Data Machines in Irvine, Calif., product manager Angus McLagan seconds the motion, adding that products using 4-k RAMs are planned. "We'll probably use what is most popular," he says. Another Irvine manufacturer, Microdata Corp., also is waiting for the dust to settle. A third, Computer Automation Inc., is using the 22-pin layout in a memory option on its new LSI-3/05 computer slated for delivery in late summer.

Getting all the 4-k RAMs it wants is Hughes Aircraft Co.'s Ground Systems group in Fullerton, Calif. A source there wouldn't say where they're being used, but says the division has utilized parts from TI, Mostek, and, in the past, MIL and Advanced Memory Systems. The firm is using basically 16- and 22-pin packages.

Among the mainframe computer makers, Control Data Corp. has made the commitment to design 4-k RAMs, "if they're available," into its computers, "but we're fortunate in that we haven't made a commitment to a candidate," says Tony Vacca, manager of CDC's advanced design lab in St. Paul, Minn. "We find that 1975 will be a lean year in terms of high-density, high-performance product.

"If any manufacturer has shown stability, it's TI," he says. "It's taken a mature marketing approach and hasn't changed the specs on its 22-pin in the last year and a half. And it's possibly the only manufacturer that has done that."

But CDC wants to use high-density packages: "the industry trend right now is toward the 16-pin, and Mostek has the only 16-pin I can get hold of," he says, "yet even it is going through a number of changes."

For large systems—(using 500,000 to 16 million words of 32 bits each), "we don't want error correction to be the only factor that gives us a tolerable reliability," Vacca says. "Our goal, for large systems, is an MTBF of 0.01% per 1,000 hours, and the best we see now is about 0.1%." □

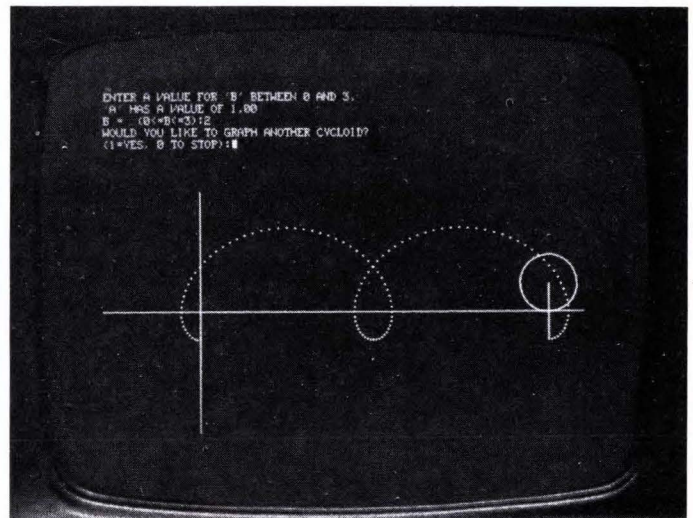
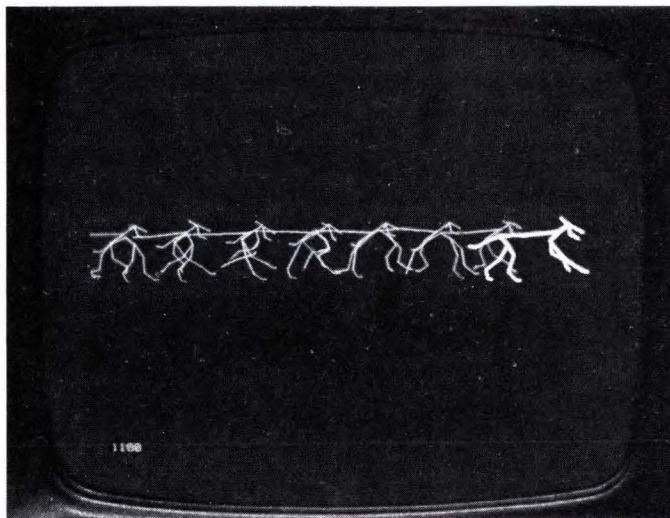
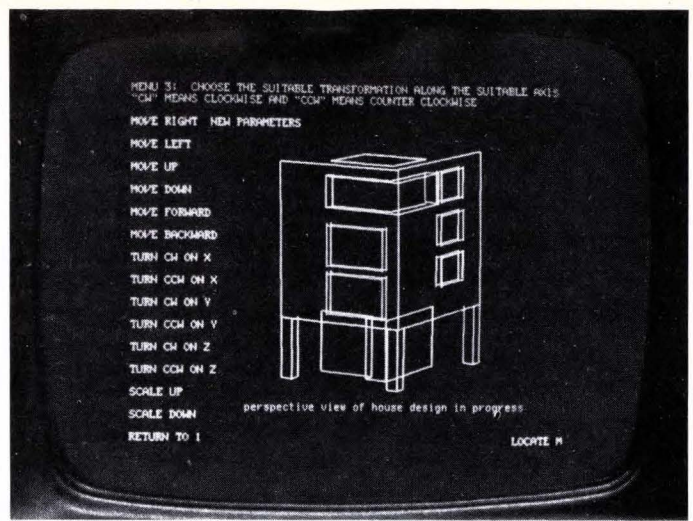
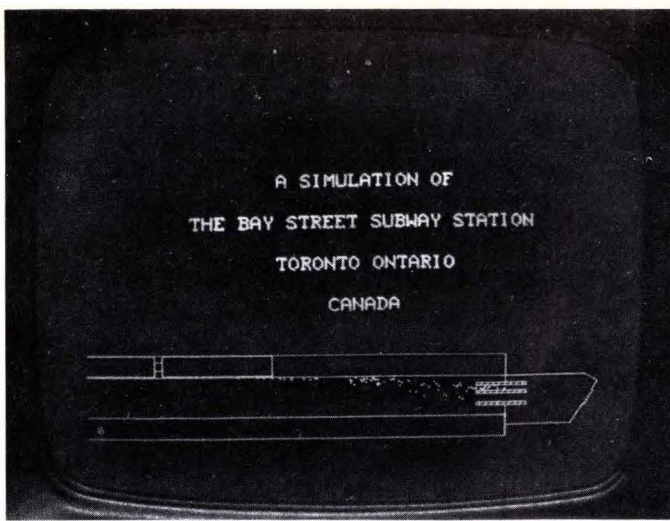

Digital announces a whole new way to look at graphics.

Right now is the time to look at graphics in a way you've never looked before.

Because graphics has come of age. And Digital feels you're about to see a tremendous increase in the use of graphic systems. In science, research, medicine, business and industry.

We've been making graphic systems almost as long as we've been making computers. And today, we may have the broadest range of computerized graphic systems available.

In our GT Series alone, we offer three multi-purpose graphic systems.

The GT40 includes a PDP 11/10 processor, 8K words of memory, keyboard, and 12" screen with light pen.

Extensive peripheral and application software is also available.

For expanded needs, the GT42 offers a 17" screen with light pen and communications interface.

And the powerful GT44 system provides a high performance PDP 11/40 processor with 16K words of memory, 17" screen with light pen, and our own DECwriter for hard copy.

Besides graphics, you can use these systems for virtually any computer application. And they're backed by an extensive array of peripherals and software. Plus Digital's worldwide service organization.

And should you already be a PDP-11 user, a graphic add-on may give you a totally new perspective on meeting your needs.

So if you're looking into graphics, be sure to see us. Write Graphics Group, Digital Equipment Corporation, Marlboro, Mass. 01752. Or call (617) 481-9511, Ext. 6936. European headquarters: 81 route de l'Aire, 1211 Geneva 26. Tel: 42 79 50.



digital

from Grayhill

the different DIP Switch

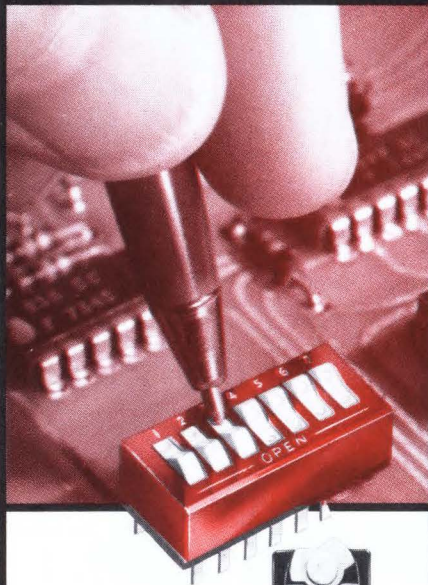

- **Exclusive sliding ball contact system** for positive wiping action



- **Life tested to 50,000 mechanical operations**, with commensurate electrical life

- **Available in 9 sizes**, even a hard-to-find 2 rocker version, on up to 10 rockers

- **All SPST**, each switch independent, rocker actuated

Of course, the different DIP Switch—Grayhill's Series 76—also offers the standard DIP benefits of easy PC board mounting, compact high density design and a multitude of cost savings. Get the full story, including detailed specifications and prices, in Grayhill Engineering Bulletin # 238, available free on request.



561 Hillgrove Avenue • La Grange, Illinois 60525
Phone (312) 354-1040

Probing the news

Companies

Xerox gets new, but familiar, look

Data Systems division, after years as integrated part of company's operations, once again is an independent group

by Paul Franson, Los Angeles bureau manager

After three years as an integrated part of the larger Xerox family, the Data Systems division has won its independence. Now, under president John C. Lewis, it has been reorganized back to where it was three years ago when it had its own responsibility for making and selling its own computer system.

But Lewis is understandably quick to point out that the interregnum was useful. "We've done a significant amount of computer development, and in doing so took advantage of all the resources of the company. Now we can capitalize better on that development with a unified operation to serve customers." Though the El Segundo, Calif., division hasn't shown a profit since it was acquired as Scientific Data Systems in 1969, says Lewis, its sales in 1974 topped 1973's by 32%. He adds that it's difficult to predict in this recession economy when his division will turn the corner, but notes that the order rate is continuing to show strength.

All this brings up the question of why the division was integrated into Xerox in the first place. The answer is found in one of Xerox' reasons for acquiring Scientific Data: not just to have a computer operation, but to apply computer knowhow to the design of other business equipment—the electronic office, as it was called back in those rose-hued days.

Some cross-fertilization seems to have occurred. The Office Systems division has introduced the model 800 word-processing system, and the models 400 and 410 telecopier both use computer technology. On the

other hand, the model 1200 high-speed printer, combining computer technology and xerography, is made by the Computer group and sold in the data-processing industry. And disk drives and printers from Diablo Systems, another acquisition and a fellow member with Lewis' group of the Special Businesses division, are also used in Xerox computer and office products.

Still, the former arrangement was not ideal for making and selling equipment in the varied markets. Under it, all Xerox products—from copiers to large Sigma 9 computers—were split among three com-

Unfiled. That's how president John C. Lewis sees the newly reorganized Xerox Data Systems division.



The IC Troubleshooters show it like it is.

READ the state of all 14 or 16 pins on IC's simultaneously with the 10528A Logic Clip. No power connections. Auto-seeking of V_{cc} and ground. Clips directly to the IC being tested. PRICE \$99.*

SEE logic highs, lows, in-between bad levels and open circuits with the 10525T Logic Probe. Capture one-shot pulses as narrow as 10 nsec. Pulse streams to 50 megabits/sec are also displayed. PRICE \$99.*

INJECT a pulse into a circuit without trace cutting or unsoldering pins with the 10526T Logic Pulser. Automatically drives low nodes high or high nodes low. PRICE \$115.*

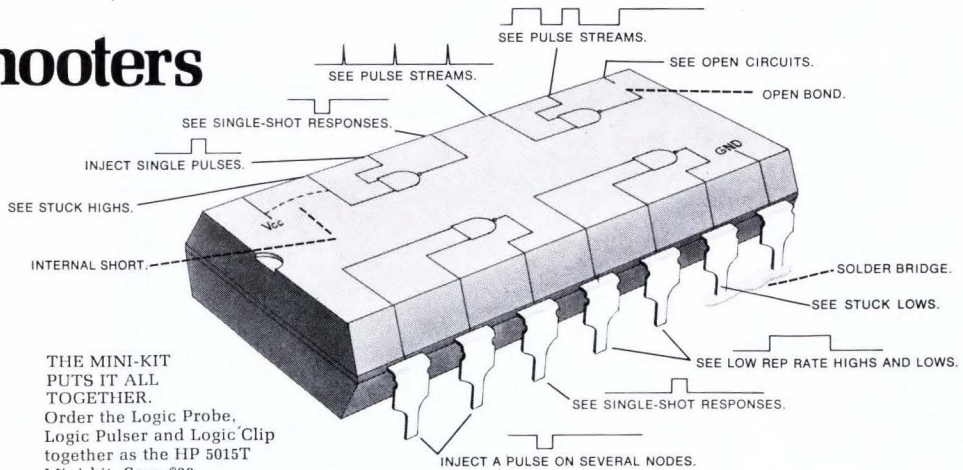

THE MINI-KIT PUTS IT ALL TOGETHER. Order the Logic Probe, Logic Pulser and Logic Clip together as the HP 5015T Mini-kit. Save \$38. PRICE \$275.*

*U.S. domestic prices only.

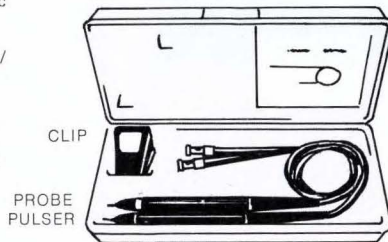

Sales and service from 172 offices in 65 countries.
1501 Page Mill Road, Palo Alto, California 94304

02507

Circle 71 on reader service card

Our 'last-long' DPMS... are your 'cost-less' DPMS!

Our DPMS have the highest level of reliability and serviceability built in! With state-of-the-art circuitry, plug-in modules, ICs and displays, our DPMS are long-lasting, dependable and easily serviced after extended use or abuse. All models feature LARGE, easy-to-read displays and operate on 115/230 VAC or 5 VDC.

DigiTec's DPMS are characterized by Readability, Repeatability, Reliability, Maintainability, Flexibility and Accuracy. Our "last-long" DPMS are your "cost-less" DPMS!



Model 2780—4 1/2 digit
.01% Accuracy • From **\$229.**

Model 276—3 digit
.1% Accuracy • From **\$139.**



Model 277—3 1/2 digit
.05% Accuracy
From **\$159.**

Contact your local United Systems representative for complete specifications and generous OEM quantity discounts. All models are available from stock.

DigiTec

UNITED SYSTEMS CORPORATION

a subsidiary of

Monsanto

918 Woodley Road • Dayton, Ohio 45403 • Ph: (513) 254-6251 • TWX: (810) 459-1728

THE POWER SUPPLY AN ENGINEER COULD LOVE



If you're an engineer, or in engineering management, you might find our new SCR Series Single Phase Input Power Supplies very attractive. They provide 800, 1600 or 2400 watts of power and precise 0.1% regulation in both voltage and current modes (for higher power ask about our three phase input SCR units). All offer the highest power output per mechanical volume in the industry.

Check these superior benefits:

- * High Efficiency
- * Remote Sensing
- * Remote Programming
- * Series or Parallel Operation
- * 5 Year Warranty
- * Rack or Bench Mount
- * Overvoltage Protected (optional)
- * Constant voltage or current with automatic crossover
- * Optional Input Voltages

For applications assistance and technical information, phone TOLL FREE (800) 631-4298

VOLTAGE	CURRENT	CV-rms RIPPLE	CC-rms RIPPLE	% EFF	AC input I NOM.E	PRICE \$
0-7.5	100	75 mv	1000 ma	63	13	650
	180	80 mv	1920 ma	65	26	850
	250	80 mv	2990 ma	66	20	1100
0-10	80	75 mv	600 ma	65	13	600
	150	80 mv	1200 ma	68	26	850
	210	80 mv	1680 ma	69	19	1100
0-20	40	60 mv	120 ma	67	13	600
	80	80 mv	320 ma	70	25	800
	120	80 mv	480 ma	73	18	1000
0-40	20	60 mv	30 ma	68	13	500
	40	100 mv	100 ma	75	24	750
	60*	100 mv	150 ma	80	18	900
0-60	13	70 mv	15 ma	70	13	500
	26	90 mv	39 ma	81	23	850
	40	90 mv	60 ma	81	18	1000
0-80	10	80 mv	10 ma	77	12	500
	20	120 mv	30 ma	83	21	850
	30**	100 mv	35 ma	82	18	1000
0-150	5	150 mv	5 ma	80	10	500
	10	200 mv	13 ma	87	20	850
	15	200 mv	20 ma	84	18	1000
0-300	3	250 mv	3 ma	85	6	550
	5	300 mv	5 ma	87	20	850
	8	300 mv	8 ma	85	17	1000
0-600	2	700 mv	2 ma	87	6	650
	3	700 mv	4 ma	88	20	850
	4	750 mv	5 ma	85	17	1100

*Specify Model No. SCR40-58

**Specify Model No. SCR80-28



ELECTRONIC MEASUREMENTS INC.

405 Essex Road, Neptune, N. J. 07753

Phone: (New Jersey) 201 - 922-9300 • (Toll-Free) 800 - 631-4298

Specialists in Power Conversion Equipment

pany-wide groups: planning, development and manufacturing, and marketing.

As one long-time, middle-level engineering employee puts it: "We were building computers along with copiers, and since there were so many more copiers we were left out on the end sometimes. We weren't visible; we couldn't tell if we were making profits or progress. Now we feel more like we're here—we will make it or break it without help or hindrance from other product lines. We see a lot of streamlining, cutting out a lot of overhead that might have been needed when we were part of the copier operation—and that's just what we were."

Now, the division is responsible for making and selling a revamped computer line. The only holdover from the old family is the top-of-the-line Sigma 9.

Favorable. Users seem to like the idea. One of the first to receive Xerox' new model 560 multiuse processor, (with the model 550, it replaces the Sigma 5, 6, and 7) is consulting engineer O'Brien and Gere Engineering Inc. in Syracuse, N.Y. Data-processing manager Robert Marshall says hardware and software support have been good. So does Thomas Cantwell, programming head at Astra Pharmaceutical Laboratories in Worcester, Mass. Astra's model 530 (replaces Sigma 2 and 3) handles work that required an IBM 360/20 card system. Cantwell says, "Xerox has done everything it could to help with early problems, and now they're solved."

Fairchild Camera and Instrument Co. has a Sigma 6 in its Mountain View, Calif., computer center, and data-processing manager Paul Christensen says it will be upgraded this year to a 560. The computer is used for engineering time sharing, and for batch processing. Christensen says that Xerox provides excellent support for both system engineering and maintenance. "The CP-5 software," he says, "which can support time-sharing, real-time, and batch in a single operating system, is a distinct advantage of Xerox equipment." □

Check the specs on this one

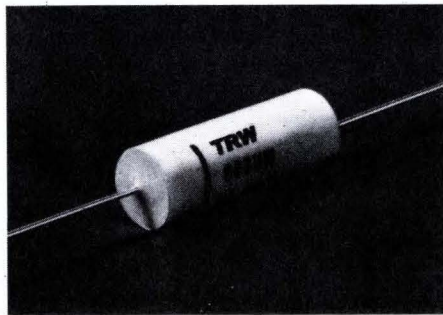

...when you need a subminiature capacitor offering "instrument" quality

With its skin-tight plastic case, TRW's Type 663UW Mylar* dielectric capacitors offer you major space savings with *no* compromise on life or reliability.

Use these TRW 663UW capacitors for high-density circuitry in computers, instruments, MIL applications. *Conservatively* rated to assure trouble-free performance in your equipment.

Complete specs on 663UW capacitors—along with a look at TRW's overall Mylar/foil capability—available on request. Write TRW Capacitors, an Electronic Components Division of TRW, Inc., Box 1000, Ogallala, Neb. 69153. (308) 284-3611.

DF: less than 1.0% at 1000 ± 20 Hz
IR: greater than 70,000 megohm-microfarads at 25°C (5X paper dielectric capacitors)
Dielectric strength: twice rated voltage for one min.
Temp. range: -55°C to $+85^{\circ}\text{C}$ (to $+125^{\circ}\text{C}$ with derating)
Stability: easily pass 10,000 hr. test with negligible drift in capacitance and DF
Tolerances: to $\pm 1\%$

*Du Pont T.M. for polyester film.

TRW® CAPACITORS

Decisions, Decisions

Digital Comparators from ERC Simplify Batching and Control Systems

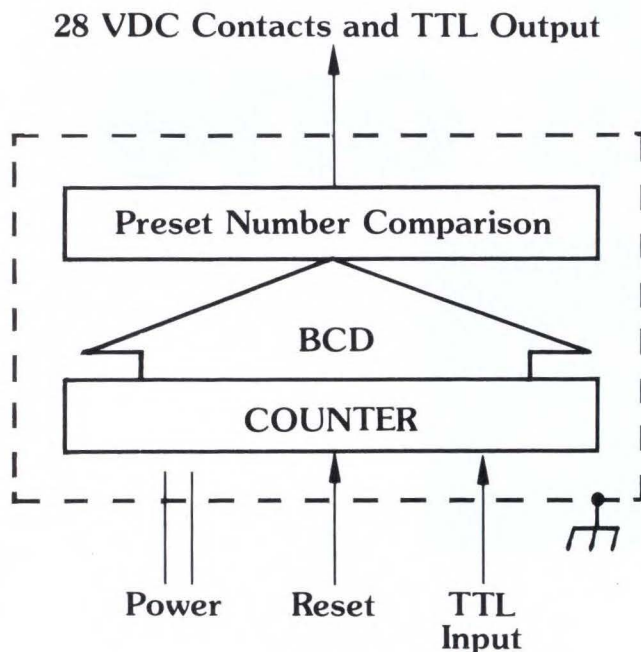

Model 2505-01, \$215

For batching applications where TTL inputs are available and display is not required the Series 2500 Preset Counter/Comparator does it all. With the auto-reset option it's a complete batching system. Three to six digit models in rugged panel-mountable aluminum cases are available with a choice of power inputs and other options. All mounting hardware and connectors are supplied.

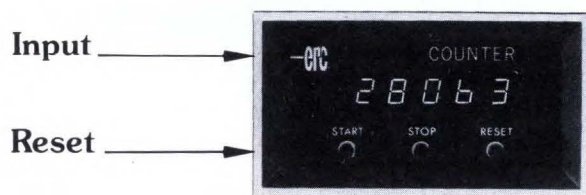

Model 2305A, \$283



Model 2515, \$230

28 VDC
Contacts
&
TTL
Output

For batching applications where transducer has TTL, contact transfer, LPTTL, or low-level sine wave output, and display or BCD is required, interface a Series 2300 Industrial Counter with a Series 2510 BCD Tracking Comparator. Single and dual limit, three to six digit models have 8 week maximum delivery; many models available from stock.

ERC's seven other series of Digital Panel Instruments can team up to solve the most complex measure-compare-control problems. For full information or applications assistance call Bill Cook at (913) 631-6700 or check the reader service card.

electronic research co. • a *Textron* div.

7618 Wedd
Overland Park, Kansas 66204
Mail to: P. O. Box 913
Shawnee Mission, Kansas 66201
Telex: 42-4130
Telephone: (913) 631-6700

ERC

Impulse-bonded wiring is economical alternative to multilayer boards

For a complex system design that remains volatile well into production, impulse bonding creates densely wired boards that, unlike multilayer circuits, are easy and inexpensive to alter

by F.G. Schulz, D.C. French, B.E. Criscenzo,
and P.T. Klotz *Bendix Corp., Teterboro, N.J.*

□ Multilayer printed-circuit boards are often the most cost-effective way of handling high-density wiring in a system in high-volume production. But they become very impractical when circuit changes continue to be made well into the manufacturing phase.

Impulse bonding, however, makes it possible to produce electronic-component assemblies that are as dense as multilayer boards but faster and cheaper to redesign. This wire-bonding process, in combination with automatic component insertion, mechanized flow-soldering, and computerized testing, is economical enough for moderately high production volumes.

Impulse bonding, as described here, is a variation on the pc-board-wiring technique called stitch wiring. It differs in using a specially developed pc board, which accommodates wire interconnections and components on the same side, and in using a brief high-current pulse to diffusion-bond the wiring to the unique pc-board pads. The interconnections are routed and bonded by programmed, semiautomatic machines.

This construction takes much less drafting time than an equivalent multilayer board and adds almost unlimited flexibility in making minor or major circuit changes, since neither the artwork nor the drilling nor the photoplatting process of the basic board is affected. In addition, the basic board can easily be converted to a

multilayer equivalent once the system design has finally stabilized.

Bendix' impulse-bonding facility, consisting of 12 semiautomatic machines, has wired over 50,000 circuit boards for such products as the flight guidance systems of the DC-10, S3-A, and Mercure aircraft, and for automatic test equipment for the F-15. A bond reliability of 0.002 parts per million hours has been attained.

Time studies and time-keeping job cards produced by the impulse-bonding computer program show that the direct recurring factory cost, including both labor and material, is about twice as much for impulse-bonded wiring as for multilayer-board processing—a 4.7-by-6-inch, eight-layer, basic multilayer board costs about \$50, and its impulse-bonded equivalent costs about \$100. However, the greater economy of the multilayer board is quickly offset if the board has to be redesigned several times or if the initial, nonrecurring cost of the artwork and photoprocessing stages must be absorbed over a short production run.

The multilayer rationale

Many of today's printed-circuit boards require as many connections between devices as an entire black-box chassis harness did 10 years ago. Such a mass of wiring or conductor runs would make the boards so

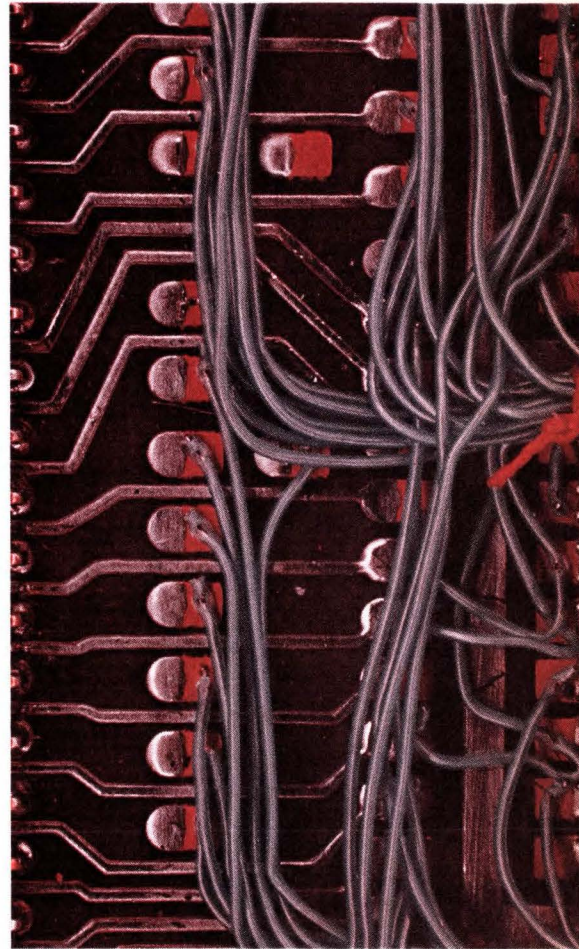

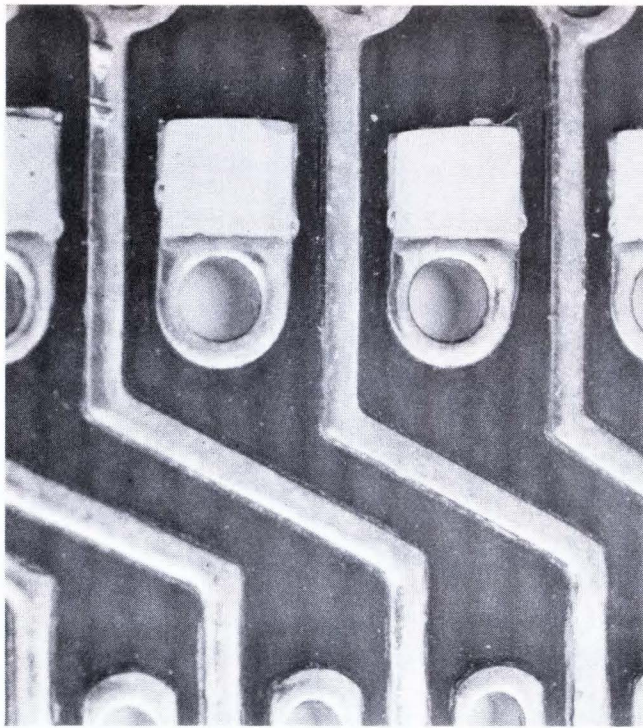

1. I-Bond pads. On impulse-bonded circuit boards, bonds are made directly to the rectangular area of the pads, shown magnified here 10 times. Components are mounted and wave-soldered in the plated-through holes beside the pads.

bulky as largely to cancel out the space-saving advantages of using IC packages.

For the most part, the aerospace electronics industry has solved this problem by adopting the multilayer printed-circuit board. However, these boards are not only tricky to manufacture—they also take a long time to design and are costly to move into production, so that they are uneconomical in small lots. Moreover, once the

necessary artwork, photomasters, and drill tapes are completed, the interconnection network is hard to change without costly and long-drawn-out rework—not the ideal situation when a design is volatile.

The logic circuits of a commercial flight control system, for instance, may be subject to change well beyond the initial production phase, as flight experience with the system accumulates, as different airlines choose different customized options, and as the aircraft progresses through several levels of FAA certification. In the case of one such system, major configuration changes affected almost every one of its 50 different multilayer boards right at the start of the manufacturing phase. To develop new artwork and get new boards into production would have taken three months per board—an impossible delay when new aircraft were constantly approaching flight service and requiring to be provided with equipment immediately.

The interim solution usually adopted was to cut pads and add jumper wires to a board, even though the initial costs and rework involved in doing this were heavy. Then, as a given multilayer board accumulated more changes and the modification costs and number of jumpers became excessive, the board was redesigned. Three months later, when production shifted to the new multilayer boards, further design changes had already occurred and the whole process immediately started up all over again.

After this experience, which lasted 18 months, the search was on for an alternative to the multilayer board.

The requirements

Above all, this other wiring method had to allow rapid and efficient changes to be made in the wiring of an electronic system until the design was stable. The wired modules had to be interchangeable with multilayer boards in function, size, and weight. High reliability of the wired connections between the components

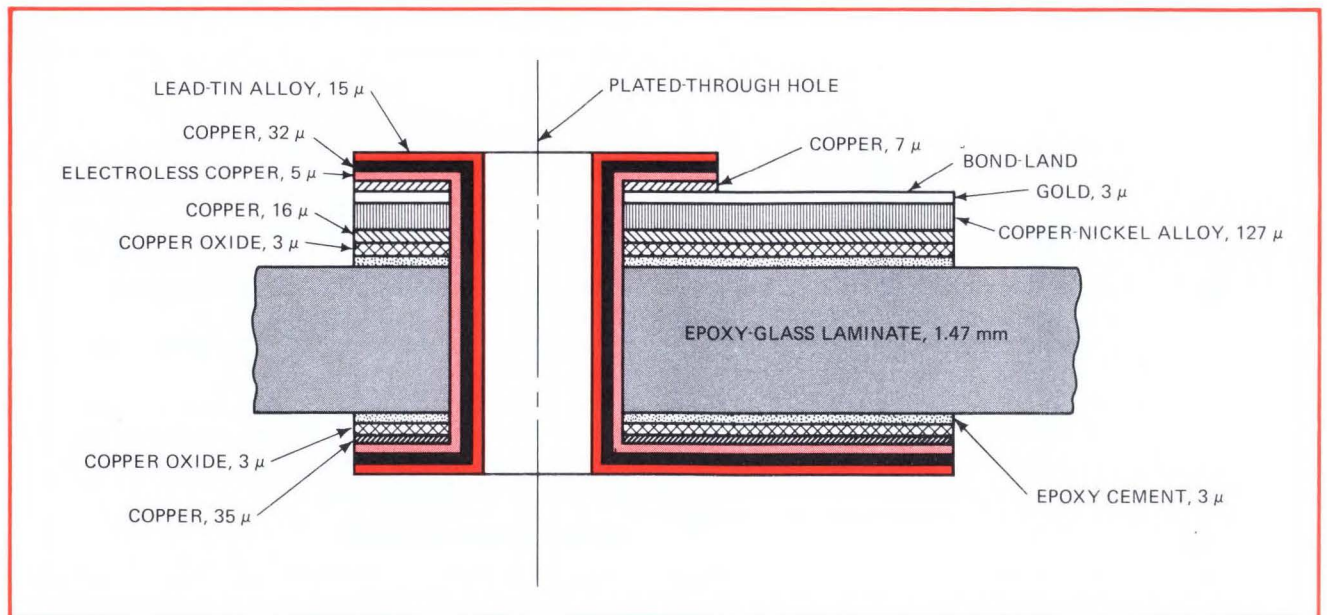

2. Pad cross section. Normal printed-circuit laminating, etching and photoplatting processes are used to deposit an I-Bond pad on an epoxy-glass board. A special material is used for the pad—a copper-nickel foil alloy, which is impulse-bonded with a nickel wire.

Three automatic board-wiring techniques

Three commercial systems have come close to meeting Bendix' automated wiring requirements for avionics systems. But in two, the components and wiring end up on opposite sides of the wiring board, increasing bulk, and in two the wiring stage precedes component insertion and soldering. The three systems are:

■ **Infobond**, an automated system of point-to-point wiring on the back of a two-sided printed wiring board (the components are on the front or other side). The 38 AWG copper wire used is solder-bonded to terminations by an automatic soldering gun. This process was developed by the Inforex Corp. of Burlington, Mass.

■ **Multiwire**, an automated interconnection system in which 33 AWG polyimide-insulated magnet wire is first laid down on a adhesive-coated epoxy-glass board. Then

terminations are formed by drilling through the wire and board and electroplating the sides of the hole. The resulting tubelets are then used for component insertion and soldering. Components and wiring are on the same side of the board. Multiwire was developed by the Photocircuits division of Kollmorgan, Glen Cove, N.Y.

■ **Stitch-wire**, a semiautomatic system of point-to-point interconnections in which gold-plated steel pins are pressed into holes in conventional printed-circuit boards. Teflon-insulated 30 AWG nickel wire is bonded to the pins. Electronic components are then soldered to terminal projections on the opposite side of the board. This process was developed by the Micro-Technology division of Sterling Electronics, Westlake Village, Calif., and by the Accra-Point Arrays Corp., Santa Ana, Calif.

mounted on the new boards was essential, and the joint failure rate had to be as good as a soldered wired connection.

The economic success of the new wiring method would depend largely on the ease of making minor modifications, substituting parts, and repairing the finished board. This is necessary for normal rework operations as well as field repairs.

Design costs, too, could be expected to be lower, since the artwork for a single two-sided board would be both much simpler and very much less than for a multilayer board. The artwork for an eight-layer board is very much more complex than that for four two-sided printed-circuit boards since the mechanical layouts, registration, and electrical interconnections of all the layers are interrelated.

Other economic considerations were the compatibility of the new process with existing automatic component-insertion and flow-soldering equipment. Also, the board had to be such that it could be redesigned back into a multilayer board once system design stabilized.

Finally, any alternative to multilayer packaging would be a linear wiring process replacing a cost-effective batch process. It would therefore have to lend itself to automation and computer processing of data bases as much as possible.

With these requirements in mind, a survey of commercially available board-wiring techniques was carried out. Several, including wire wrapping, were discounted because of wiring density or cost considerations. At this stage, a key decision was reached: to make the interconnecting wiring the last step in the manufacturing operation—that is, after all the components have been installed and flow-soldered in place.

Out of the three approaches that seemed possible (see "Three automatic board-wiring techniques," above), stitch wiring offered most promise for Bendix' particular application. However, it suffered from the following set of drawbacks:

■ Having the components on one side of the board and the wiring on the other side creates a module too thick to fit into a chassis designed ultimately to hold multilayer boards.

■ The steel pins used as device terminals are too heavy for some avionic products—they typically add 3 ounces (85 grams) to a 5-oz (142-gm) module.

■ The gold plating on the pins dissolves when a component is unsoldered from them, so that subsequent resoldering is difficult and this hampers repair and rework.

■ The cost of the pins and of their insertion, even with automatic equipment, is quite high.

■ Manufacturing costs also are relatively high, because neither installation nor mechanized flow-soldering of electronic components is practical.

The impulse-bonding technique

The impulse-bond (I-Bond) wiring method finally adopted uses the same type of bonds and bonding equipment as stitch wiring. The steel pins of stitch wiring are eliminated, however, and instead the impulse bonds are made directly to unique pads on a specially developed board. Wiring and components are on the same side of the board.

The composite I-Bond pad (U.S. patents pending) combines a plated-through hole with a rectangular bond land (Fig. 1). The hole contains the lead of an electronic device, and the interconnecting wire is bonded to the land. The entire pad configuration is deposited on the epoxy-glass board by standard printed-circuit processes.

Crucial to the success of the technique was the careful choice of materials for the wiring, composite pad, and bonding-machine electrode. Altogether 12 metals and alloys were evaluated for the bonding area of the pad, and six copper alloys (as well as several tip-dressing geometries) were evaluated for the upper and lower electrodes of the weld-head.

The use of stainless steel for the pad was considered because it bonds better than other metals to nickel wire. But stainless steel proved hard to laminate and etch on an epoxy-glass board economically and with sufficient uniformity and adhesion. What really ruled it out, though, was the difficulty of soldering anything to it without either special plating or the use of acid fluxes, which are prohibited on most circuit boards.

In the end, a copper-nickel pad foil alloy and a high-

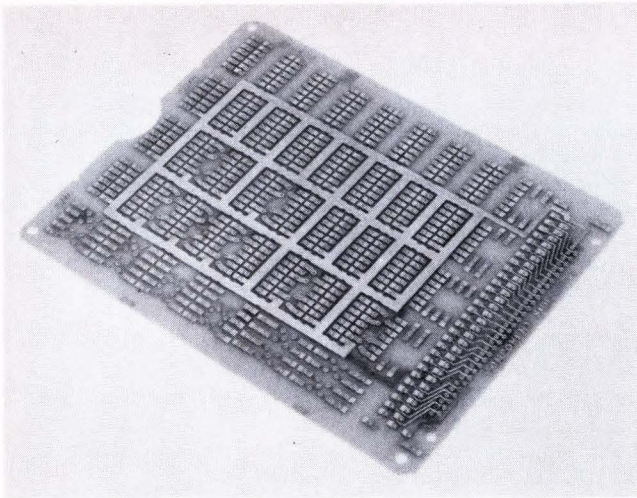

3. An impulse-bonded board. The impulse-bonding process uses a two-sided board with very simple artwork. Each board is designed to accept a wide variety of components including axial-lead devices, discrete semiconductors, DIPs, and crystal-can relays.

4. Top-side wiring. Wiring is impulse-bonded to the board after all components have been wave-soldered. Wiring on the component side allows the board to be tested on the other side by automatic test equipment with "bed of nails" fixtures.

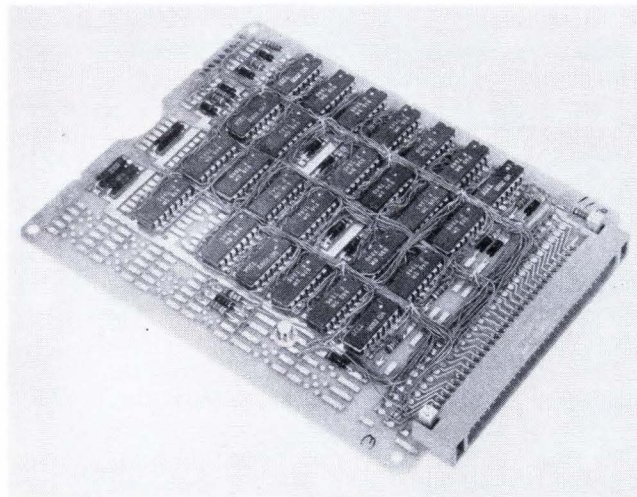

purity nickel wire were found to be the most compatible materials for impulse-bonding. Average peel-strength of the bond exceeds 4.5 pounds (2 kilograms). Pad adhesion, as measured by peel-strength of the alloy from the epoxy-glass board material, exceeds 11 lb per inch (2 kilograms/centimeter) of conductor width. These pad materials are shown in the plating-strata cross section of Fig. 2.

Also shown in Fig. 2 are the intermediate platings needed to insure adhesion to the epoxy-glass board and the materials required to build up the plated-through hole. With the composite pad shown, it is possible to repair impulse-bonded wiring by cutting the impulse-bonded daisy-chained wire and then soldering a copper wire into the adjacent plated-through hole, next to the component lead.

Impulse bonding creates a hybrid resistance-bonded

joint by exploiting the molecular diffusion and cohesion that can occur between two surfaces held in intimate contact, particularly when under high temperature and pressure. The term "bond" is used instead of "weld" to emphasize the absence of the localized melting and weld-nugget formation that are characteristic of fusion-welding.

Solid-state bonding

Primary driving force behind the molecular diffusion is the heat generated by the power dissipated when a 300-ampere, 3-millisecond dc pulse is passed through the nickel wire and the gold-plated copper-nickel pad. In general, the heat flux generated at the bond joint is

$$H = I^2RTK$$

where I = current, R = resistance of work (wire, pad, plating interface, etc.), T = time of current flow, and K = a factor representing total conduction, radiation, and convection heat losses.

Actually, each of the above factors is a complex term depending on contact area, pressure, bulk-section geometry and transient heat-transfer properties of the three elements involved—the electrodes, nickel wire, and composite pc-board pad, including its adjacent plated-through hole. The maximum temperature in the immediate bond zone is probably in the range of 1,945 to 2,200 degrees fahrenheit—say 2,100°F. The temperature at the interface between the nickel wire and the copper upper electrode of the weld head may be somewhat higher than 2,100°F, but it is still below the melting point of the wire.

During each bonding cycle, reel-fed wire is passed through a hollow upper electrode, which lowers upon operator command. The rim of the upper electrode (or cathode) bears the wire against the pad surface and applies enough stress to split the Teflon insulation of the wire longitudinally and force the now bared conductor against the cathode rim and the gold surface of the pad. When the force increases to about 9 lb, the nickel conductor pierces through the 3-micrometer-thick gold-plating and sinks approximately 25 μm into the copper-nickel layer of the pad.

When the force applied by the cathode reaches 9.5 lb (4.3 kgm), a permanent magnet in the weld head breaks free and reduces it to 4.5 lb (2 kgm). At this point, the 300-A, 3-ms bond pulse passes from the upper electrode to the lower via the plated-through hole, resistive heating occurs, the gold film in the immediate contact areas melts and is displaced under pressure, and molecular diffusion bonding between the nickel wire and copper-nickel pad takes place.

The board described

The circuit board used in impulse bonding is quite like a conventional two-sided pc board, except that it has very little interconnecting artwork (Fig. 3). The pad patterns on the board are designed to accept a wide variety of electronic components, including axial-lead devices, semiconductor cases, dual in-line packages, and crystal can relays. In general, the interconnecting conductor-runs are limited to power distribution and

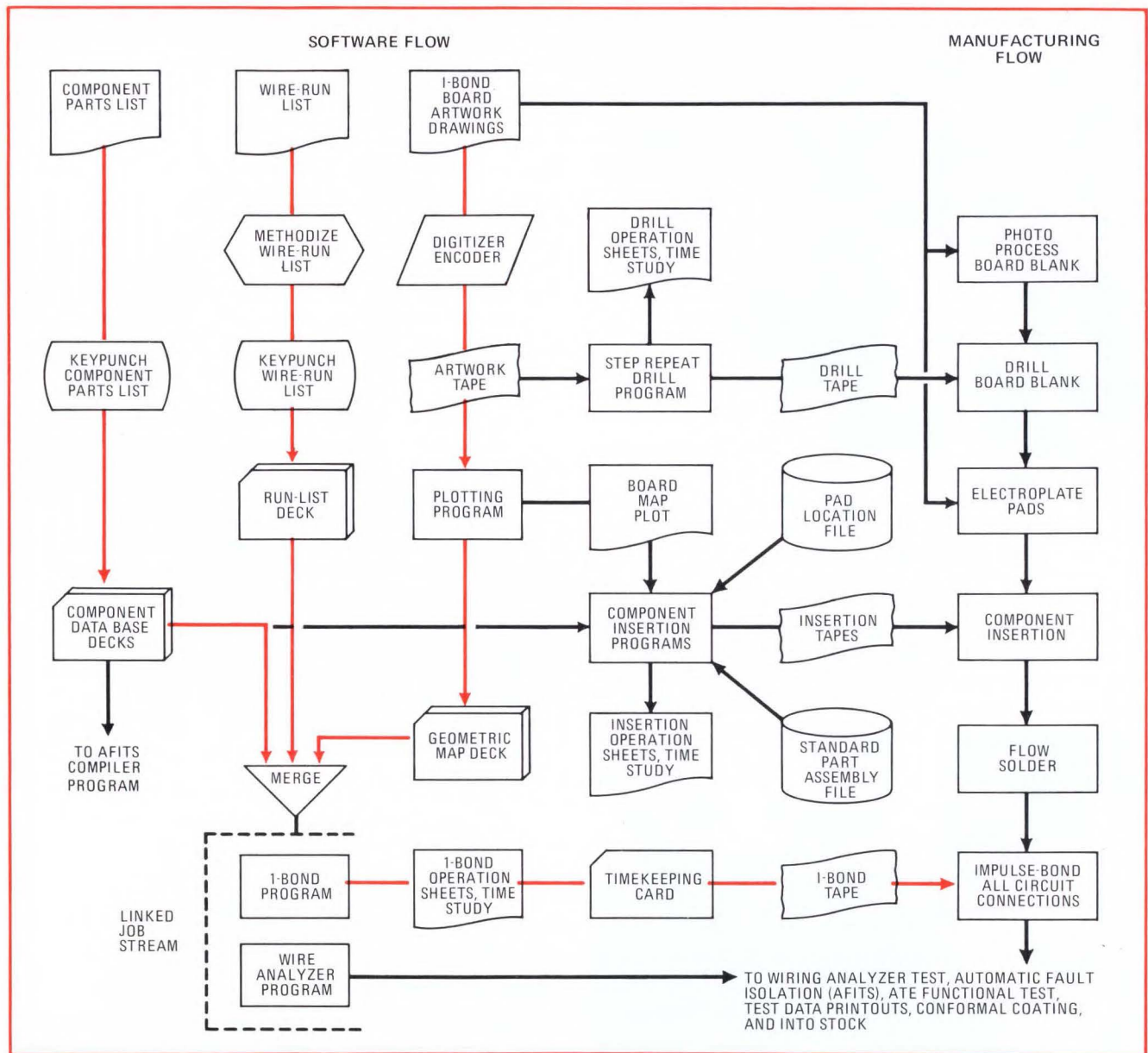

5. Computer-aided manufacturing. Software for board drilling, component insertion, interconnection, testing and time studies are under direct computer control in this process. Colored lines highlight inputs that control the final impulse-bonding step.

ground-plane busses. Layout of this board is quite simple compared with a multilayer equivalent since the designer is primarily concerned with geometric component placement and grouping of related devices.

By keeping the basic board designs sufficiently general, the start-up time, start-up cost and manufacturing inventories for new product designs can be minimized. For example, the total recurring drafting documentation for new electronic-component assemblies that use a standard I-Bond circuit board reduces to: a schematic diagram, parts list, wire run list and an over-all component assembly drawing. Also the commonality of the basic boards would allow both reduced design costs and inventories since one multiple-board could support a variety of assembly modules.

To keep the assembled board from becoming any thicker than a multilayer board, wiring is done on the

component side of the board. This also allows the use of conventional automatic and semiautomatic component-insertion equipment, permits the mechanized flow-soldering of all components on the board, and frees the non-component side of the board for use in automatic testing equipment that incorporates the "bed of nails" type of fixtures.

However, component-side wiring does reduce component density by 10% in comparison with a well-designed multilayer board. A completed impulse-bonded module is shown in Fig. 4, before an acrylic conformal coating is applied to seal and ruggedize the board.

In the making

The major steps in the manufacture and test of a typical impulse-bonded assembly of electronic components are outlined in Fig. 5. The process begins with construc-



6. Semiautomatic wiring. The semiautomatic bonding station consists of an X-Y positioning system, weld head, welding power supply, and a digital current monitor and alarm. The display panel indicates route, bond and cut commands to the operator.

7. Test station. Continuity and insulation tests on a completely wired board are done on an automatic wiring analyzer and a special universal contact fixture. If measurements are run continually at a low voltage, no damage results to active components, like semiconductors and integrated circuits, already assembled on the board.



tion of the special I-Bond circuit board from blank copper-clad epoxy-glass material by means of numerically controlled drilling equipment and conventional photoplotting processes. Electronic components are mounted either automatically or semiautomatically on the I-Bond circuit board and are secured to the pad matrix by a mechanized flow-soldering process. However, the components are not interconnected until the last step in the assembly process—the installation of the impulse-bonded wiring.

Note that, prior to this step, the component interconnections were not fixed. Changes are easily made in the key-punched run list used in the program that provides tapes for the bonding machines and also the wiring analyzer. After wiring, the assembled module then

passes through three levels of tests for wiring, component integrity, and functional operation.

Software and the computer processing of the data bases which define the assembled module are a vital part of the I-Bond manufacturing and test process (Fig. 5). The Fortran IV procedures that generate machine-control tapes for the bonding machines and circuit analyzer are derived from programs used for wire-wrapping equipment. The programs used to generate tapes, time studies and operation sheets for the equipment that inserts components in I-Bond boards are identical with those used for conventional pc boards. Also, the automatic component fault-isolation and functional testing provided in house is supported by general-purpose computer facilities and programs developed for all avionic products.

These procedures help make the impulse-bonded wiring technique economically viable because they reduce much of the documentation cost normally associated with a linear-wiring process. For example, the computer-output of the job stream includes:

- Operation sheets for the bonding process, including a sequential run list showing route points, bond points and bond-and-cut points, wire-trajectory information, and total node-lengths.
- The numerical-control tape for the bonding machines which controls machine position, traversing speed, and bond-route-cut indicator displays.
- The time-study analysis sheet, including details of the I-Bond wiring time-standard for this particular component assembly.
- A timekeeper's rate card, used to credit each bond-machine operator for work performed.
- The numerical-control tape for the automatic wiring analyzer machine.
- Diagnostic trouble-shooting sheets in component terminology, used with the wiring analyzer to isolate specific wiring faults in the assembled board.

Semiautomated wiring

I-Bond circuit boards are wired at the 12 stations shown in Fig. 6. Each semiautomatic bonding station consists of an X-Y positioning system and weld head, manufactured by Accra-Point Arrays Corp., Santa Ana, Calif., a special welding power supply, and a digital-current monitor and alarm system.

The circuit board is mounted on the variable-speed servoed table beneath the fixed weld head. In the weld head is a small display panel that tells the operator whether to route, bond, or cut the wire in front of her. Universal tooling adapters register the board accurately on the table and also provide wire bundling features which aid the operator during wire lay-in.

The display-panel commands, together with table position, and traversing speed, are controlled by the machine's numerical-control unit. The step-by-step advance of the machine is controlled by the operator.

Wire routing paths are not random, but are defined by machine routing commands and the operation-sheet computer printouts (previously discussed) that guide the operator in dressing the mini-harness. The wires are sorted into bundles under the direction of the software

program, which groups them in accordance with their functions, pick-up susceptibility and so forth. This assures a repetitive wiring operation and a consistent product.

The welding power supply, manufactured by Hughes Aircraft, Oceanside, Calif., consists of a nickel-cadmium battery bank together with adjustable pulse-timing and amplitude-shaping networks. However, the sensing feedback of the unit was modified to provide constant-current operation instead of constant-voltage operation during pulse discharge.

This modification was necessary because a constant-voltage source allows the total heat-flux in the immediate bond zone to vary with any change in series-resistance. But series-resistance changes radically with only small variations in the distance from the wire-pad contact point to the plated-through hole, which conducts the current to the lower electrode. Variations in the plating strata of the pad and plated-through hole will also alter total series-resistance. Therefore, a constant-current power source was essential to control the temperature in the bond zone.

This temperature is indirectly monitored by the digital current monitor, whose readings are actually proportional to the combined amplitude and duration of every current pulse. Upper and lower limits are set on this value, and an audible alarm sounds when the limits are exceeded.

Process controls and reliability

Like resistance-welding processes in general, the impulse-bonded wiring technique requires careful controls and process monitoring if joint strengths are to be consistent. These controls apply to the bonding-station equipment as well as the nickel wire, the composite pad, and the laminated board. The weld head, positioning system, power supply, and current monitor system at each bonding station are each periodically calibrated to individual equipment specifications and, more importantly, as an over-all system.

Basic to this calibration is the periodic development of a chart for each station that correlates the pulse energy delivered at the electrodes with the peel-strengths of the joints produced on a test board. Other factors in the bond schedule—the conductor-exposure force, bond-pressure force, electrode geometry, pulse duration and waveform—are held fixed by individual calibrations; the cable lengths, power-supply compliance, and weld-head characteristics are predetermined by the particular work-station equipment.

The curve on the chart then is used to determine the optimum input-energy point based on maximum joint-strengths, and the current monitor and alarm system is adjusted to allow only a $\pm 5\%$ deviation from this setting before the alarm goes off.

The current alarm system therefore detects when bond temperature is either too low for adequate diffusion bonding or so high that it may cause pad-burning, zapping or weld-blowout, or localized fusion-welding that would embrittle the joint.

To date, the reliability of impulse-bonded termination has been excellent, as demonstrated by impulse-

Diffusion bonding explained

In molecular diffusion bonding, the molecules of one metal enter (diffuse into) the crystalline lattice structure of another and vice versa, forming a so-called "solid solution." It only happens when the two metals are similar enough in molecular and crystalline structure for their atoms to fit into each other's lattice without recrystallization.

In the bonding process, heat, together with high pressure on the contact face, accelerates the diffusion. But the temperatures in the bond zone must not be so high that they cause localized melting or fusion and recrystallization and the formation of a weld nugget. If this fusion and unannealed recrystallization take place, the bond joint is weakened, being compromised by embrittlement.

Generally, when surface diffusion occurs between a metal and its alloy or between two alloys, the atoms tend to move from a region of high concentration into a region of lower concentration. In the case of impulse bonding, for instance, the nickel atoms from the wire tend to migrate across the contact face to the copper-nickel pad, and copper atoms from the pad tend to diffuse into the nickel lattice of the wire.

bonded assemblies in airborne service. For an 18-month flight-service period, with 8.1 billion bond hours accumulated, the joint failure rate is 0.002 parts per million hours (ppmh). This compares very well with the accepted failure-rate predictions of 0.034 ppmh and 0.079 ppmh for the airborne soldered-wire termination and resistance-weld termination, respectively.

Three-level testing

Impulse-bonded component assemblies undergo three levels of testing in which three types of equipment are employed. An automatic wiring analyzer tests the photoplated artwork and the circuit connections installed by the bonding machines. An automatic fault-isolation test system tests the parameters of the individual components using guarded-resistance and capacitance measurements. Finally, automatic test equipment evaluates over-all functioning of the entire assembly to assure its proper operation and to guarantee the interchangeability of assemblies of the same type.

The wiring analyzer consists of a commercial tape-programmed circuit analyzer together with a universal contact fixture with a complement of pressure-pin test modules (Fig. 7). It was adapted from a test facility originally developed for circuit testing of bare multi-layer boards. Both the analyzer and the fixture are equipped for kelvin (four-wire) measurements of continuity and insulation resistance of up to 1,500 points on the component assemblies.

The test complex has been invaluable in screening out the various manufacturing defects that can occur in the I-Bond wiring process. An interesting feature of this testing is that by running the continuity/anticontinuity measurements at a very low level (less than 0.5 volt), it is possible to ignore the components already assembled on the board. □

Inverting transistor boosts integrator's time constant

by Roland J. Turner
General Electric Space Division, King of Prussia, Pa.

Designers of low-frequency analog instrumentation will welcome an integrator that can provide a large time constant with a low-value capacitor. The accompanying circuit does just that. Its integration time constant is the RC product multiplied by the current gain of a superbeta Darlington transistor. Moreover, this circuit has high input impedance, which is an absolute necessity in such applications as an integrator driven by a peak detector. And it offers a third characteristic that is desirable for any integrator—its transient response is critically damped, which prevents integration from being seriously disturbed by noise or transients.

The key feature of this integrator is the inclusion of an inverting transistor in the feedback loop to the input of an operational amplifier. Because the transistor provides inversion, the incoming signal can be applied to the high-impedance noninverting-input terminal of the operational amplifier. The process of inversion, i.e., degenerative feedback through the integrating capacitor, provides critical damping. The value of the capacitor is effectively multiplied by the current-gain factor of the transistor.

The circuit diagram shows that the 741 op amp is connected as an amplifier, with the incoming signal applied through 10-kilohm resistor R to the high-impedance noninverting terminal. To prevent high-frequency oscillations and to limit low-frequency noise, part of the output from the 741 is fed back to the inverting input through a parallel resistor-capacitor combination. The op amp drives a 2N4974 pnp superbeta Darlington

transistor. The transistor is biased by the voltage drops across the two zener diodes and across the emitter-to-base junction, which produce a dc base drive of 2 microamperes through the 50-kilohm resistor. The 4.7-kilohm resistor is not critical—it merely limits the current through the 1N573A zener to about 1 milliampere.

Current gain in the transistor, β , is 5,000, so the dc collector current is 10 milliamperes. This current, flowing through the 1-kilohm resistor, centers the voltage level for integrating capacitor C at -7 volts so that the integrator can handle both positive and negative inputs.

When signal e_i is applied at the input to this circuit through resistor R, the output signal of reverse polarity, e_o , is fed back through integrating capacitor C to the noninverting terminal of the op amp. The over-all transfer function of the circuit is

$$A(s) = e_o(s)/e_i(s) = -1/R\beta C s$$

A conventional op-amp integrator using the same R and C would have a transfer function of $-1/RCs$. Thus, to provide the same transfer function, the integrator that includes a transistor can use a capacitor that is smaller by the factor β . Or, if the capacitor value is held fixed, the transistor provides an integrating time constant that is larger by the factor β .

The circuit shown here has an effective time constant

$$\begin{aligned} \tau &= \beta RC \\ &= 5,000 \times 10,000 \text{ ohms} \times 0.1 \times 10^{-6} \text{ F} \\ &= 5 \text{ seconds} \end{aligned}$$

To achieve this time constant, a conventional op-amp integrator would require a 500-microfarad capacitor.

This integrator circuit can function effectively at any frequency that the operational amplifier can handle, and at any signal level that does not saturate the transistor. Any of several operational amplifiers can be used; the 741 was chosen here for its good compensation. Likewise, many transistor types can be used. The 2N4974 was chosen for its availability and high β . □

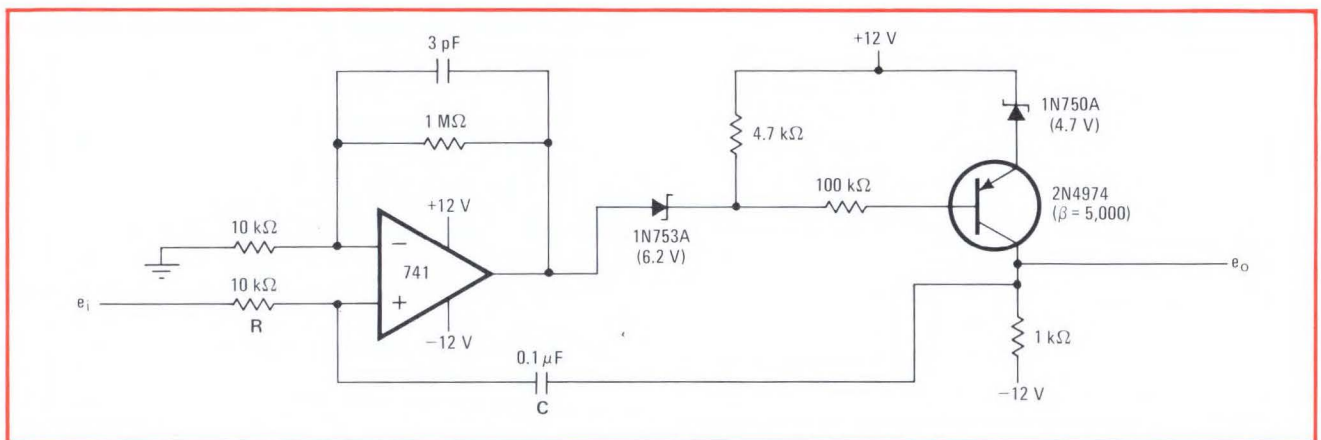

Integrator. Operational amplifier plus transistor makes integrator with large time constant, despite small size of integrating capacitor C. The circuit shown here has an effective time constant βRC of 5 seconds. Feeding the noninverting input terminal of the operational amplifier gives high input impedance, and degenerative feedback through the transistor provides critically damped transient response.

ICs interface keyboard to microprocessor

by Donald P. Martin and Kerry S. Berland
Martin Research Ltd., Chicago, Ill.

A compact, economical interface between a keyboard and a microprocessor can be designed with only three integrated-circuit chips. The ICs are a 5740 MOS scanning keyboard encode, a 2812 MOS first-in/first-out (FIFO) memory, and a 74125 quad three-state buffer. All three can be mounted with the standard array of keyswitches and diodes on a single circuit board.

The 5740 keyboard encoder has 10 scan inputs and nine scan outputs. A unique combination of one input and one output is assigned to each key, adding up to 90 keys in all. The keys are wired between the scan inputs and the outputs with a diode in series, as shown in the circuit diagram. The diodes block sneak signal paths and eliminate "phantom key" effects if several keys are pressed at the same instant.

Internal ring counters simultaneously scan both the key matrix and an internal read-only memory. When a key is pressed, the ROM word corresponding to that key is transferred into a one-character nine-bit output latch.

The word includes the seven-bit ASCII code for the character, parity bit B8 (which is not used in this design), and the selective repeat bit B9. The 5740 requires an external clock oscillator in the 10-to-200-kilohertz range to drive the scanning counters; this can be obtained from the main timing circuit of the microprocessor.

The internal circuitry of the encoder also performs other necessary functions; it suppresses keybounce effects, responds to key closures even if the previous key has not yet been released, and senses the shift, shift lock and control mode keys.

When the encoder recognizes a keystroke, it sets its data strobe output high. This terminal is wired directly to the encoder's data strobe control, an input terminal that resets the encoder output on the next falling edge of the keyboard clock. The data word is thus available at the encoder for only one clock period.

If no more data storage were provided than the one character stored by the encoder, the microprocessor would have to test for new keyboard data at a rapid rate. This requirement would be a severe constraint on the software, so the 2812 FIFO is included in the interface to provide storage of up to 32 characters.

The keystroke that sets the encoder data strobe high also stokes the parallel load (PL) input of the FIFO and loads the ASCII character into the FIFO. The loaded character moves down through the 32 positions until it either reaches the output or is stopped by a previously

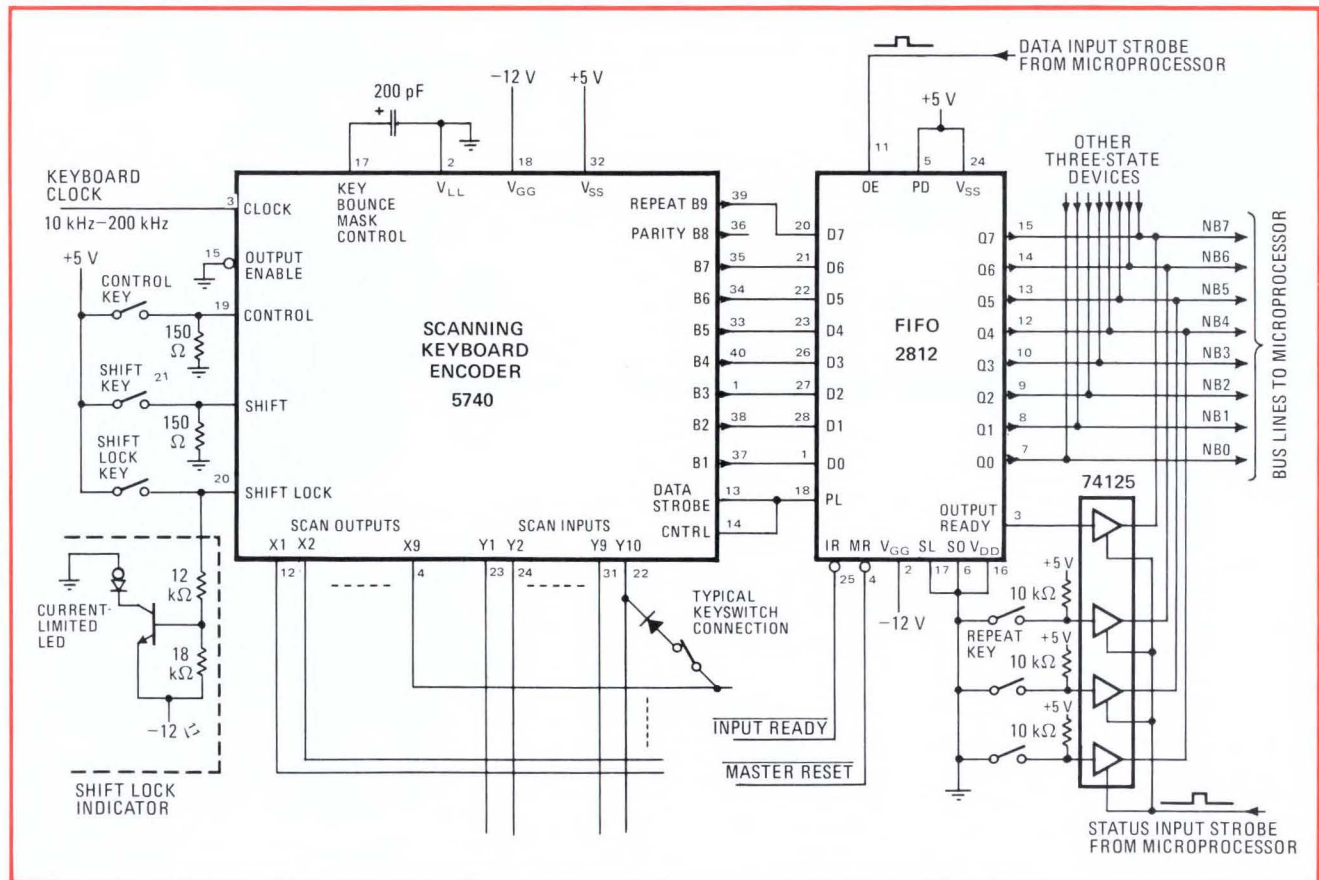

Interface. Three ICs connect keyboard to microprocessor. Encoder provides up to 90 keys. FIFO stores 32 characters. Connections to microprocessor are made through three-state devices to the same 8 bus lines as used by other data sources. All three ICs can be mounted with keyswitches and diodes on a single circuit board, so when keyboard is not included in system, neither are interface components.

Everything's coming up Cambion

Cambion is coming up with new ways that let you develop your IC systems to their fullest potential without component restriction. With Cambion's Double QQ approach and evergrowing line of digital/integrated packaging products, even your most advanced IC systems ideas become practical. Your Quality needs are met, no matter how great the Quantity – that's the Double QQ. And for quantity, everything at Cambion is coming up an endless variety of components. So extensive you'll never have to think "specials" again.

What's coming up next? Look in Cambion's new Catalog 119-A. Featured are: advanced new Cambi-Cards®, card files, drawers, universal panels with and

without pre-mounted socket strips and power planes, specific logic function cards, general purpose and discrete component cards, plus strip connectors, cable assemblies, integrated socket strips, component socket adaptors, cable cards and card extenders. You'll discover products that keep ahead of your design needs. Order a Cambion Catalog today from: Cambridge Thermionic Corporation, 445 E Concord Ave., Cambridge, MA 02138. Phone: (617) 491-5400. In Los Angeles, 8703 La Tijera Blvd. 90045. Phone: (213) 775-9472.

Standardize on

CAMBION

The Guaranteed Electronic Components



stored character. When there is at least one character stored in the FIFO, the output ready signal goes high. This signal is periodically tested by the microprocessor to see whether there is new data from the keyboard. With the FIFO providing buffer storage, the microprocessor needs to test for input data far less frequently.

The FIFO's parallel dump (PD) control is permanently enabled (wired to +5 volts). However, the parallel dump function is also internally gated with the output enable (OE) terminal; therefore the first-received character will not be dumped until the OE terminal is activated. Thus a single strobe to the 2812 first reads the keyboard word into the microcomputer, then dumps the word out of the FIFO, moving the next keyboard character into the output position. The delay between the leading edge of the data input strobe and the appearance of valid data on the microprocessor input bus is less than 400 nanoseconds for the 2812.

When power is first applied, the FIFO registers are cleared by a signal from the master reset circuit of the microprocessor. This signal goes low for a fraction of a

second, preventing the FIFO from taking on initial random states that could be interpreted as keyboard data.

To load information into the microprocessor, status input and data input instructions are used. The microprocessor periodically pulses the status input strobe line. This pulse activates the 74125 three-state buffer, which puts the FIFO's output ready bit on the high-order input bus line of the microprocessor. (This is input bit 7, or NB7.) The microprocessor tests this bit to see whether keyboard data is available; if the bit is high, indicating that a character is stored in the FIFO, the microprocessor executes a data input instruction. This instruction activates the output enable terminal of the FIFO, and impresses the keyboard data word on to the input bus to the microprocessor.

The seven lower-order bits of the keyboard data word are the ASCII-encoded character. The high-order bit, NB7, is the selective repeat bit B9. The repeat switch is connected to the next-highest bit through an extra three-state buffer. The repeat function is implemented easily through a few instructions stored in the ROM. □

Digital command inverts signal

by Craig J. Hartley
Baylor College of Medicine, Houston, Texas

Many digital designs require voltage-controlled signal inversion. The circuit shown here accepts bipolar inputs with amplitudes up to ± 7 volts and has a gain of either +1 or -1, depending on the logic level at the control terminal. A TTL-logic level of 1 produces a gain of +1 (no inversion of the input signal), and a logic level of 0 produces a gain of -1 (signal inversion). The circuit uses a 741 operational amplifier and two transistors.

When the control logic is high, both Q_1 and Q_2 are turned off, and the operational amplifier becomes a voltage follower. The input signal E_i is present at both input terminals and at the output terminal of the op amp, so no current flows through resistors R_1 , R_2 , or R_3 . Therefore the gain in this logic-low mode is independent of the values of the resistors and is given by

$$E_o/E_i = +1$$

When the control logic is low, both Q_1 and Q_2 are saturated, so the noninverting terminal of the op amp is grounded and the input signal is applied only to the inverting terminal. Therefore the gain is

$$E_o/E_i = -R_2/R_1$$

In this circuit R_1 and R_2 are equal, and therefore the gain in this logic-low mode is

$$E_o/E_i = -1$$

In this mode of operation, there is an offset proportional

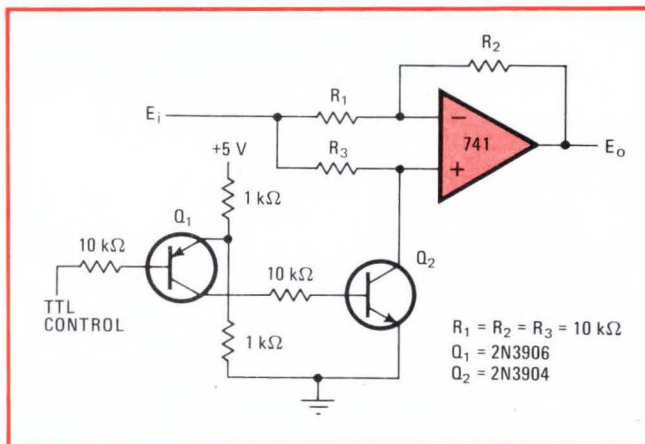

Voltage-controlled inverter. Circuit transmits or inverts input signal, depending on logic level at control terminal. Logic 1 produces a gain of +1 (no inversion), and logic 0 produces gain of -1 (inversion). Maximum signal swing is ± 7 volts. Offset is about 0.02 volt.

to the saturation voltage of Q_2 :

$$V_{\text{offset}} = V_{\text{sat}}(1 + R_2/R_1) = 0.02 \text{ V}$$

Because this circuit is intended to handle bipolar input signals, Q_2 must be driven by a high-impedance source such as Q_1 , so that Q_2 is turned off by having its base open-circuited, rather than by having its base grounded. If the base of Q_2 were grounded, negative input signals to the circuit would forward-bias the base-to-collector junction and distort the output signal. With the circuit shown here, the negative input swing is limited by the base-to-emitter breakdown voltage of Q_2 (i.e., 6 to 10 v), while the positive input swing is limited only by the op amp saturation voltage. □

Designer's casebook is a regular feature in Electronics. We invite readers to submit original and unpublished circuit ideas and solutions to design problems. Explain briefly but thoroughly the circuit's operating principle and purpose. We'll pay \$50 for each item published.

Five points to keep in mind when evaluating Logic-Circuit Testers...

- 1 When testing complex boards, you spend most of a tester's available time troubleshooting defective boards.
- 2 Troubleshooting can be time-consuming and costly.
- 3 Not all test systems troubleshoot equally well.
- 4 Software is the least understood and the most important part of any test system.
- 5 The system that provides the best hardware/software integration minimizes troubleshooting time and expense.

The last point separates the GR 1792 Logic-Circuit Test System, with its new CAPS VII software package, from all other logic-circuit testers. CAPS VII provides a one-two troubleshooting punch that produces a K.O. every time. If its AFL (automatic fault location) doesn't knock down the trouble within seconds, you can call on the new "Smart Probe" to deliver the knockout punch quickly and decisively.

Call or write to any of the offices listed below for complete information or to arrange for an exhibition match.

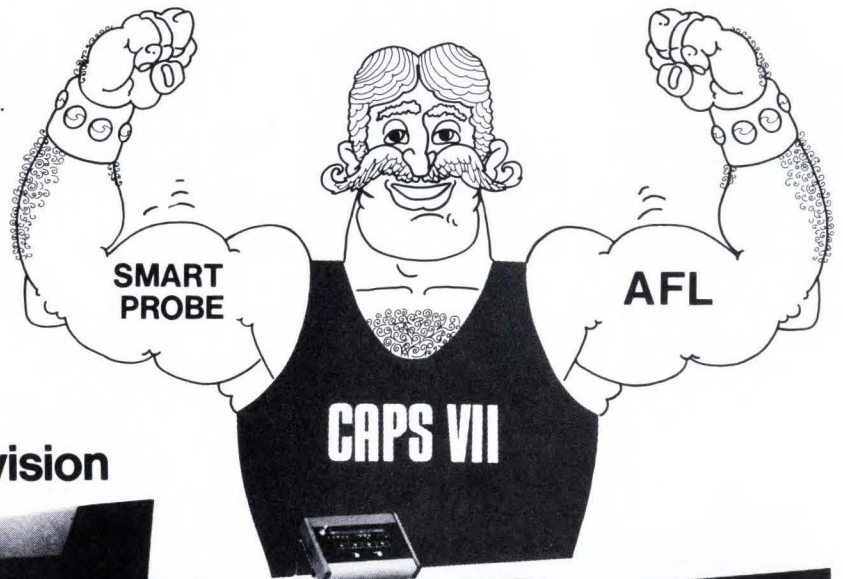

General Radio GR Test Systems Division

300 BAKER AVENUE, CONCORD, MASSACHUSETTS 01742

NEW YORK (N.Y.) 212 964-2722, (N.J.) 201 791-8990
BOSTON 617 646-0550 • DAYTON 513 294-1500
CHICAGO 312 992-0800 • WASHINGTON, D. C. 301 948-7071
ATLANTA 404 394-5380 • LOS ANGELES 714 540-9830
SAN FRANCISCO 415 948-8233 • DALLAS 214 234-3357
TORONTO 416 252-3395 • ZURICH (01) 55 24 20

GR COMPANIES
Grason-Stadler • Time/Data

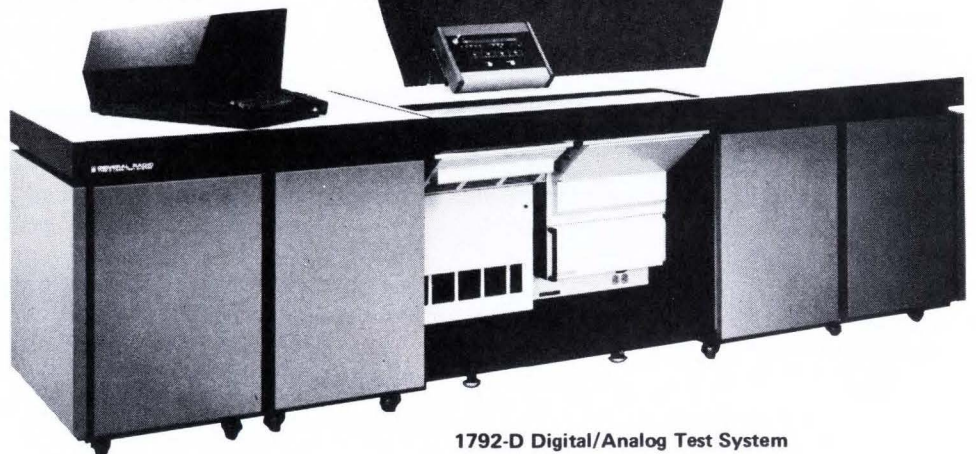

1792-D Digital/Analog Test System

Four-chip microprocessor family reduces system parts counts

Basic two-chip system, consisting of microprocessor and read-only memory, handles simple applications by itself but can also be built into complex multiprocessing systems with the aid of memory access and interface chips

by David Chung, Fairchild Semiconductor Corp., Mountain View, Calif.

□ A system designer's enthusiasm for the one-chip microprocessor often fades once he starts developing an actual system. True, the chip replaces dozens of MSI logic chips or hundreds of small-scale ICs. But it may require the addition of several logic and memory circuits and a couple of clocks before becoming even a minimally self-contained system. Probably the microprocessor will also need address and data buffering if it is to be used with peripherals, and then there are clock-generation and timing circuits, memories and input/output control, multiplexing, and interrupt capability to be considered.

What the system designer needs is a group of just a few compatible chips capable of handling all these functions. What the chip manufacturer needs is processing technology and a system architecture that will pack these functions on small chips, since only small chips will assure the high production yields that keep costs low. The F8 family of four n-channel chips provides the necessary circuit density by combining the MOS version of Fairchild's Isoplanar process with a novel architecture on which designers in the areas of systems, logic, circuits and software all co-operated.

The F8 chips consist of an 8-bit microprocessor or central processing unit (CPU) with a 2-microsecond processing speed, an 8, 192-bit read-only memory organized as 1,024 8-bit words, a memory-interface chips, and a direct-memory-access chip. The CPU communicates with other F8 circuits over an 8-bit bidirectional data bus and five control lines.

The distribution of F8 system functions is unique among microprocessor chip sets. For example, the CPU chip contains much more logic than usual yet does not have a program counter

for addressing memory. Instead, each ROM and memory interface chip has its own program counter, as well as a stack register and data counter. An incrementer/adder is also located on each of these chips so that addresses may be modified locally. Thus the need for a 16-bit address bus between chips is eliminated, and the CPU and ROM are left with 16 pins free for use with input/output devices.

Five system-design advantages

The chip set helps its users meet five system-design objectives: cost-effectiveness, minimum parts count, simple peripheral interfaces, easy expansion through modular architecture, and simplified programming.

Yields on the CPU chip are high and manufacturing costs low because the device is the smallest now being produced—it measures only 181 and 155 mils, despite its unusual number of functions. Also eliminated is the need for external chips and other components, and, with few exceptions, the F8 chips are electrically compatible with many devices, whether a TTL gate or a switch.

For many applications, such as calculators and appliance controllers, a two-chip "minimum" system—CPU and ROM—will suffice, while the other two chips allow the system to move upward into much more complex applications. This minimum system is defined as one that includes a random-access memory, I/O circuits, computing electronics, clock generators, power-on reset circuits, an interrupt structure, a timer, and of course a ROM. Chip size was reduced some 40% by using, not conventional MOS techniques, but the Isoplanar version of n-channel MOS (which is slightly different from the Isoplanar process devel-

1. **The system.** The four F8 chips—a central processing unit, read-only memory, memory interface, and direct memory access—communicate over an 8-bit data bus and five control lines.

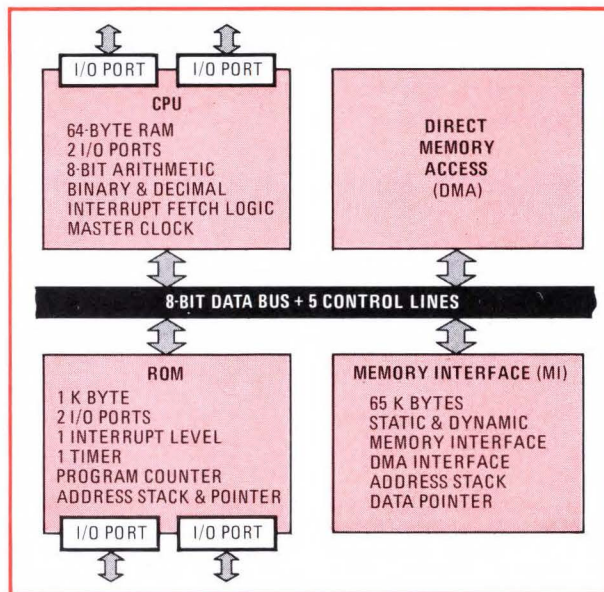

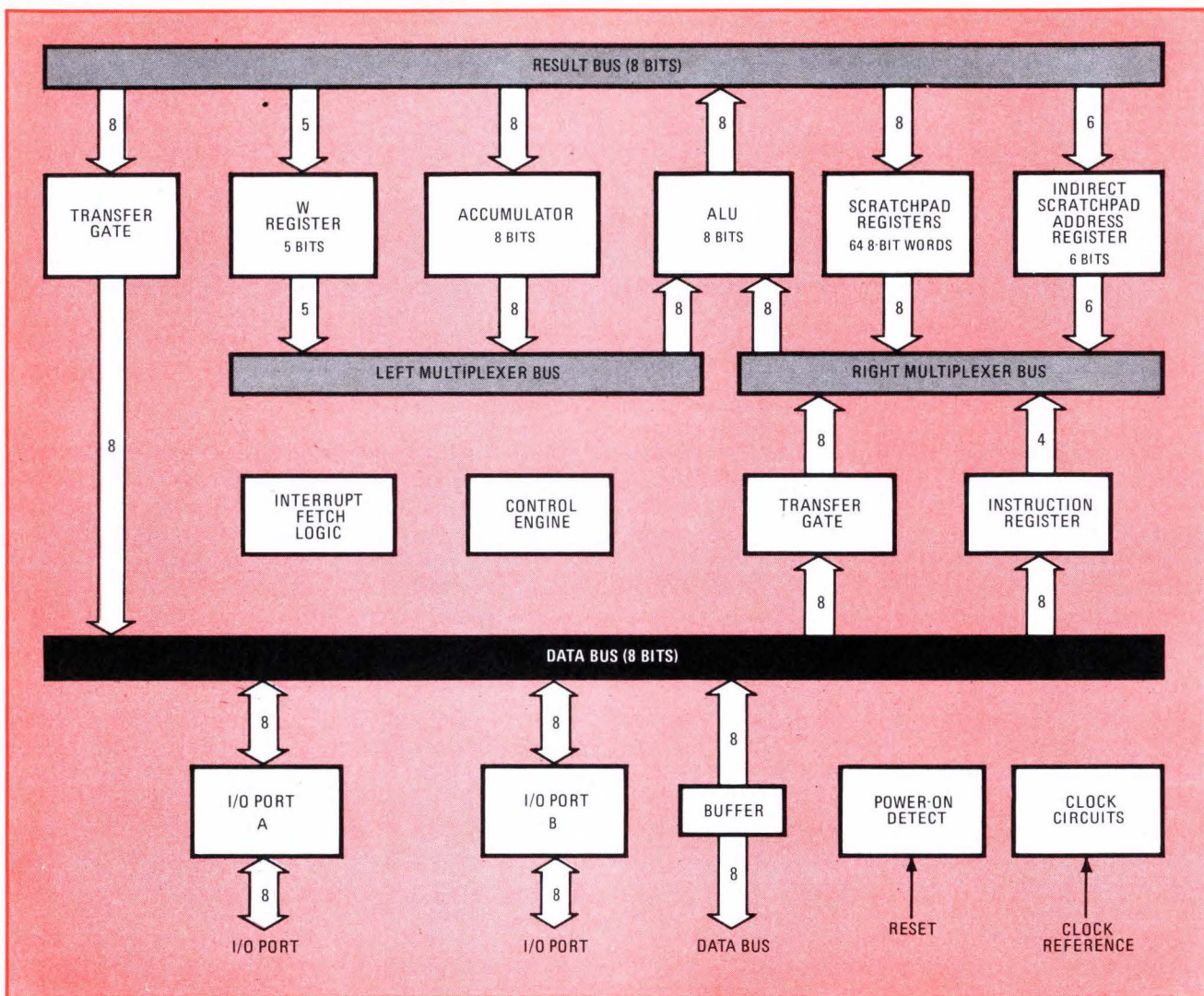

2. Central processor. The F8 CPU chip has two 8-bit input/output ports, which result from placing the 16-bit addressing circuits directly on the mating read-only memory chip. It also has a 64-word-by-8-bit random-access memory for use as a scratchpad.

oped by Fairchild for bipolar integrated circuits). Consequently, the first five of the minimum system's functions, plus part of the interrupt structure, were packed onto a CPU chip that is 10% to 45% smaller than some popular microprocessors that contain only a CPU function. The rest of the interrupt structure and the timer are on the ROM chip.

Direct interfaces can be made with a wide range of peripheral devices because enough hardware is incorporated on the CPU and ROM chips to allow the idiosyncrasies of most I/O devices to be handled by software. This hardware includes the interrupt structure and timer already mentioned, plus encoding and decoding circuits and bidirectional ports, which can serve as input or output lines at different times. As a result, the chips can directly handle approximately 95% of today's I/O devices, including keyboards, printers, readers, displays, modems, and magnetic devices.

The minimum two-chip system is also the basis for a modular architecture that can handle increasingly complex problems with no theoretical upper limit. As many two-chip modules as necessary may be used to solve, in

piecemeal fashion, the most complex system requirements. One of the key characteristics of this approach is that each individual system can operate independently, yet can communicate with one system that acts as a coordinator.

There were some architectural tradeoffs. In looking at the frequency with which certain operations are normally performed, emphasis was placed on I/O speed (most F8 microprocessor instructions are I/O-oriented) and lower parts count, although some versatility in memory references and double shift was sacrificed. The double-shift feature, however, is primarily of value for binary multiplication, which also can be done through software, and in most cases, repetitive memory reference can be eliminated by efficient programing.

In fact, carefully thought out software systems should alleviate many of the difficulties facing microprocessor users today. Although a low-cost, nonvolatile RAM (for permanent, but alterable, storage of programs) is not yet available from any supplier, there is a variety of prototyping units using programable ROMs which provide an easy and inexpensive way of developing and

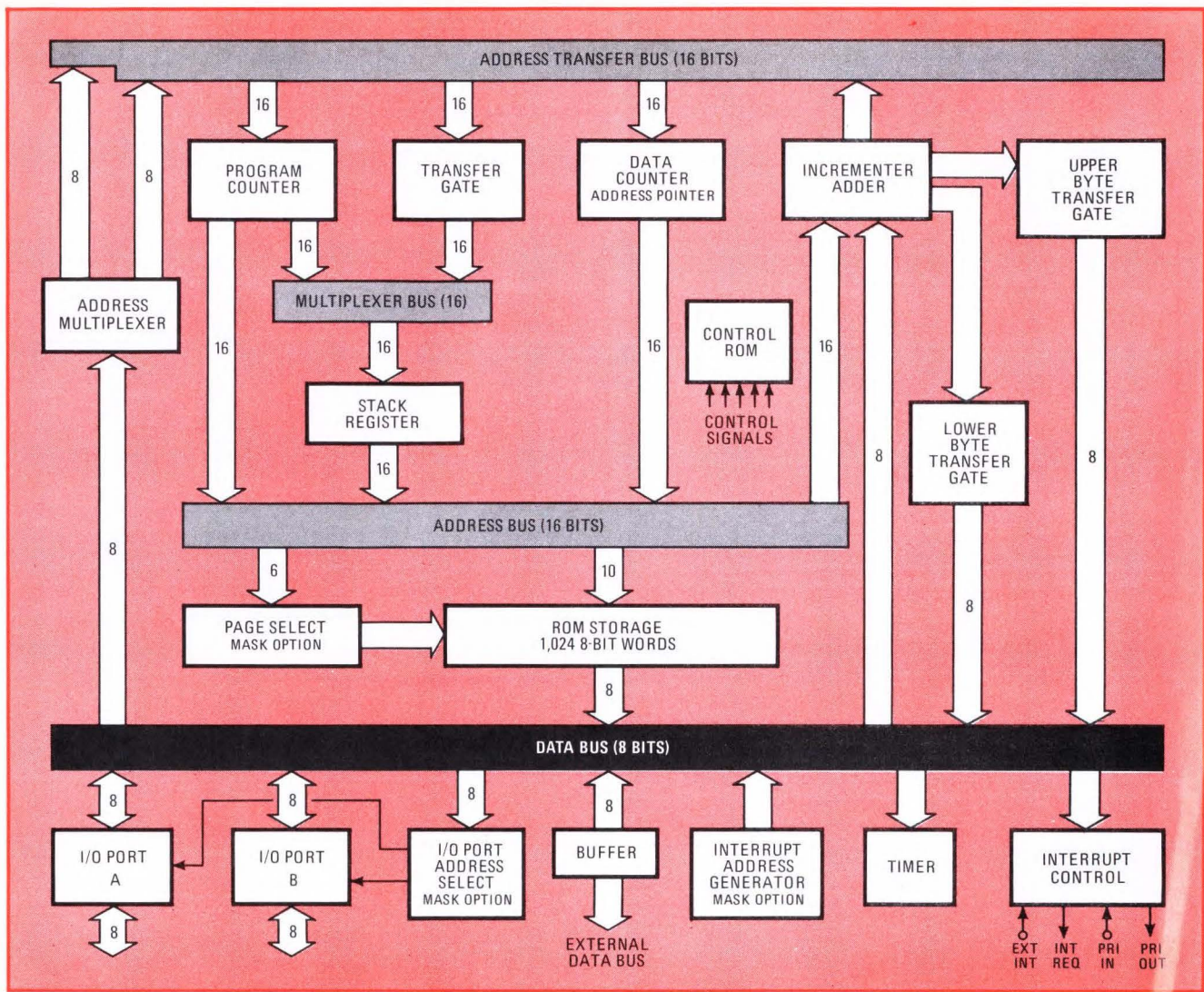

3. Read-only memory. In addition to the 8,192 storage cells, the F8 ROM chip has its own 16-bit program counter and address bus. This frees 16 package pins for use as two 8-bit input/output ports. The ROM also has an interrupt input and a timer.

verifying microprocessor software, even for small-quantity users. Three software packages—an assembler, simulator, and a stand-alone conversational operating system—have been developed, as well as a terminal specially designed for the F8 microprocessor chip set.

The CPU chip

Despite being the smallest 8-bit, n-channel microprocessor chip available, the F8 CPU contains the most logic. It includes the following circuits:

- Arithmetic logic unit, an 8-bit parallel logic network that can be used in binary or decimal functions.
- Accumulator, an 8-bit storage register that stores the results of arithmetic operations and transfers information into or out of the scratchpad memory.
- Scratchpad memory, a group of 64 8-bit registers that serve as read-write memories and may be used as a workspace by a programmer.
- W register, which stores the status indications from an arithmetic or logical operation.
- Two bidirectional 8-bit I/O ports, which can be used either for gathering data from external circuits or for

outputting data to other circuitry.

- Clock circuits, which generate the necessary two-phase clock signals used by all other parts of the system. Operating frequency is set externally by either an RC network or a separate clock or, if a precise operating frequency is required, a crystal.
- Interrupt fetch logic, which allows CPU operation to be interrupted by a timer on the ROM chip or by an external source. A unique feature of the F8, it permits the microprocessor to operate on a real-time basis and also generates control signals. The combination of timers, priority interrupts, and buffered outputs and inputs allows the F8 to serve as a peripheral controller.
- Power-on detect, another vital circuit, which causes the CPU to disable the interrupt system and also insures that processing starts out from a unique address when power is first applied.

The ROM's role

The ROM, with 1,024 8-bit bytes of storage, is used principally to store programmed instructions and non-volatile data constants that will be fetched as operands

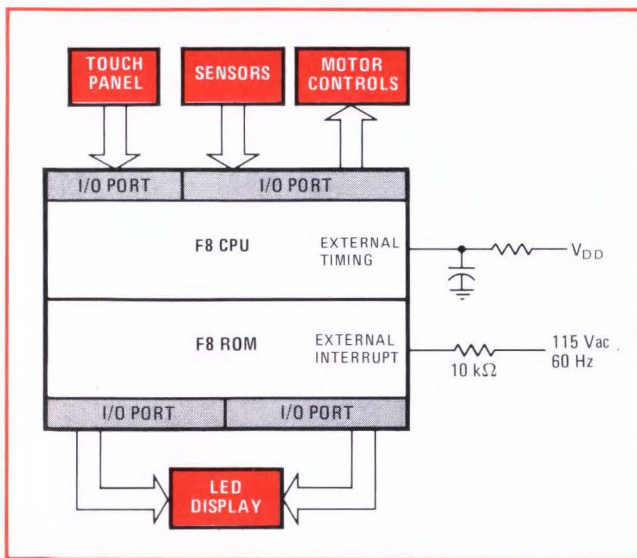

4. Fewer pieces. When an electrical appliance controller was redesigned around the F8 CPU and ROM chips, its parts count dropped from 250-plus to 55, including LEDs and motor-control components.

while the CPU executes a program. In a typical system, the ROM can be interfaced directly with the CPU without buffer circuits.

The ROM has a different architecture from the kind of ROM commonly used with microprocessors. In addition to storage cells, each ROM contains circuits that enable it to add a second interrupt level and also to provide extra processing capability independent of the CPU.

The ROM includes the following circuits:

- Program counter, which contains the address of the next instruction byte to be fetched from memory and is automatically incremented after each fetch cycle.
- Stack register, which receives the contents of the program counter whenever an interrupt is generated and also aids in developing a multilevel program function.
- Data counter, which acts as a self-incrementing pointer for conveniently referencing data addresses in memory; because it is 16 bits long, it can address up to 65-k bytes of memory.
- I/O ports, which are fully bidirectional and contain storage latches and Schmitt triggers at the input for noise rejection, thus eliminating the need for external latches and external noise-rejection circuits.
- Interrupt address generator, which provides the next instruction address when an interrupt occurs.
- Timer, which greatly increases the versatility of the system, since it can interrupt the CPU's performance of routine tasks and switch it to servicing real-time equipment after a preset time interval. For example, as data is transmitted to a printer, the timer keeps track of the elapsed time and at the end of the transmission starts the next operation automatically, without the usual loop delay for interrogations from the CPU. The timer also is useful for generating waveforms (which can be changed by software) for control functions.

A two-chip system

The two-chip F8 microcomputer is suitable for small data terminals, controllers, and specialty calculators.

The keyboard is connected directly to the F8 I/O ports without special interfaces. Switch-bounce protection, rollover, and key encoding are all under software control. Software also decodes signals for LED readouts.

As an appliance controller, for example, the two-chip system can perform all input-output sensing, actuating, timing, and computation operations. A system like the combination washing-machine-and-dryer controller in Fig. 4 required more than 250 components when other microprocessor chip sets were used, but with the F8 chips uses only 55 components, including 28 LEDs and the power semiconductor devices and relays used to control the motors. A set of custom chips would also have required about 50 parts, but initial engineering expense would have been heavy and severe penalties would have been incurred if changes were required. With the F8 system, changes could be made by merely changing the program.

The same dramatic reduction in parts count has been achieved in yet another application—as the controller of an optical wand system. This controller was implemented with a p-channel 8-bit microprocessor using some 50 parts. It has since been replaced with a two-chip F8 system.

A more complex system

A system of medium complexity can be designed by adding more ROMs. The 16-bit addressing permits up to 65,536 bytes of ROM storage—and each additional ROM adds not only another 1,024 bytes of storage but also an extra interrupt level, an extra system timer, and two more 8-bit I/O ports.

The versatility of such a system is indicated by the traffic-light-control system in Fig. 5. The use of one CPU and two ROM chips provides the designer with two timers, two interrupts, an inboard clock, inboard power-on reset, inboard switch decoding, and 48 bidirectional I/O bits. This system could be tied to vehicle detectors in the road, to monitor traffic for left-turn lanes as well as through-traffic flow in four directions. It would also react to interrupts from the pedestrian control buttons at each corner. There also is sufficient I/O capability to permit communication with and control of neighboring intersections and to allow the system to be operated manually or tested for proper operation.

Five F8 features are of particular interest for this type of application. One of the interrupts can eliminate the need for such external circuits as a comparator to compare a count of the cars with a predetermined value to cause the light to change. (The CPU can handle the simple arithmetic of counting cars.) This interrupt also eliminates the need for continuous polling of traffic count by the microcomputer. The second interrupt would be ideal for permitting pedestrian control to override the automatic system. The internal clock, with an external crystal, can also control light routines.

The two timers permit simultaneous counting of delay for vehicle signals and flashing warning lights for pedestrians. The inboard power-on reset acts in case of power failure to start the system automatically when power is renewed. The bidirectional I/Os have built-in latches that eliminate the need for external latches for

the job of "holding" commands for lights as well as the momentary commands provided by timers and sensors.

More complex requirements still can be broken down so that they can be handled by more than one micro-computer. For this purpose, the two additional F8 chips may be used.

A memory-intensive system

The memory interface chip allows standard memory chips, such as the 1103, the 2102, or 4,096-bit memories, to be incorporated into the F8 system. One version of the memory-interface chip handles static memory elements such as the 1,024-bit 2102 RAM, and another version interfaces with dynamic memories, such as the 1,024-bit 1103 RAM and the 4,096-bit RAM, with on-board refresh logic for 4-k memories. The second version also provides interface signals required by the direct-memory-access chip.

This memory-access chip, which cannot be used without the second version of the interface chip, is used to set up a high-speed data path between the F8 memory and a high-speed peripheral (such as a magnetic-tape

unit), a first-in, first-out memory, or another two-chip F8 microcomputer.

A typical application is a printing credit-verification terminal (Fig. 6). Such a system requires high performance and yet must be low in cost if it is to reach a large market. Only four different F8 chips are required to handle a keyboard input, visual display, card reader, and printer as well as provide a modem interface and memory interface for external RAM storage. Such a system might be compared to a "bare mini" in terms of utility, but it costs less and has fewer parts and a more flexible I/O structure.

Using additional chips, independent F8 microcomputers can be connected into a synergistic multiprocessing complex in which each system can operate independently yet can be controlled by one CPU that is established as the coordinator. Three microcomputers, each having a CPU and two ROMs, use the memory interface and direct-memory-access chips to share RAM storage, which serves as an efficient three-way exchange.

In this system, all three microcomputers can operate

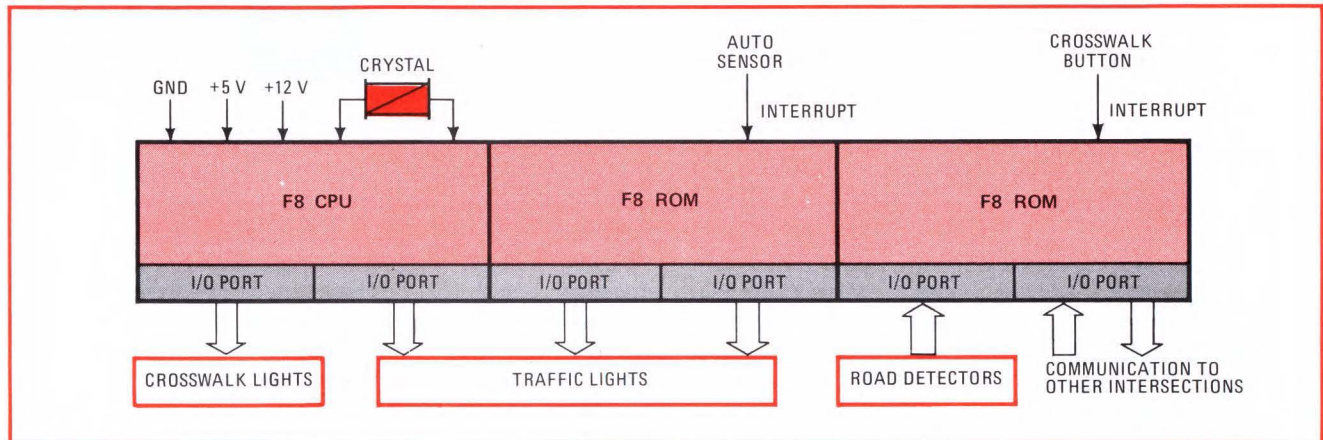

5. Versatile. As a traffic-light controller, one F8 CPU and two F8 ROMs can count passing autos, provide a pedestrian crosswalk interrupt input, and also time the traffic-light changes. An external crystal precisely sets the clock frequency.

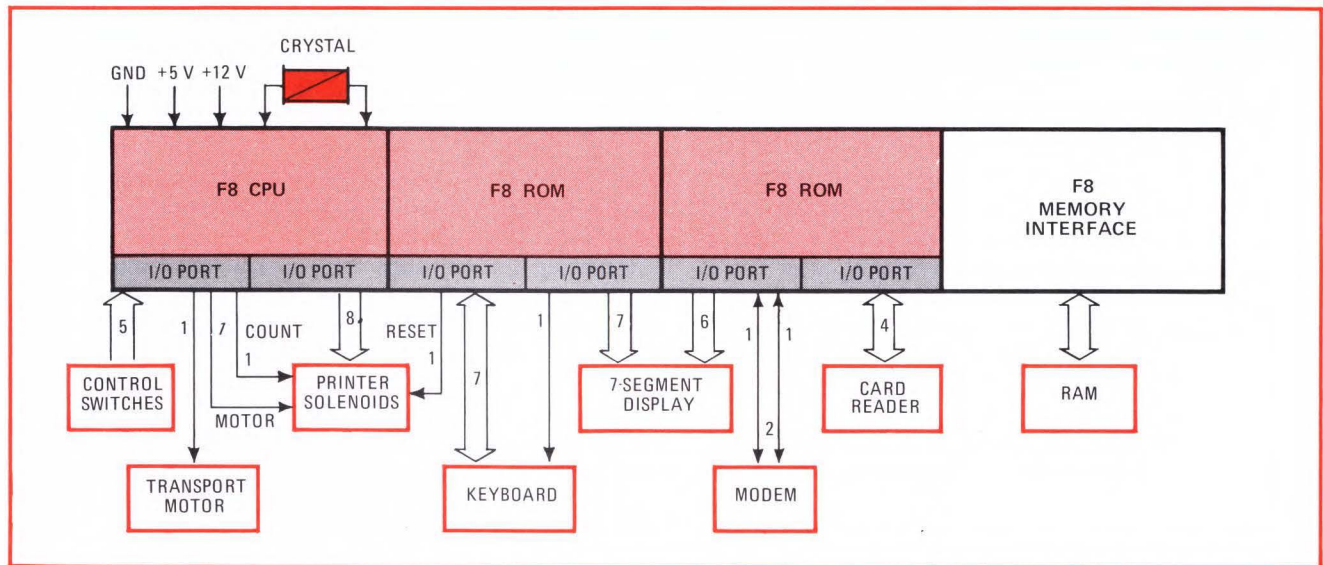

6. In charge. In a credit verification terminal, one F8 CPU, two F8 ROMs, and an F8 memory interface circuit can handle all the inputs and outputs. Each I/O port handles eight bits, which can be allocated among the various I/O devices.

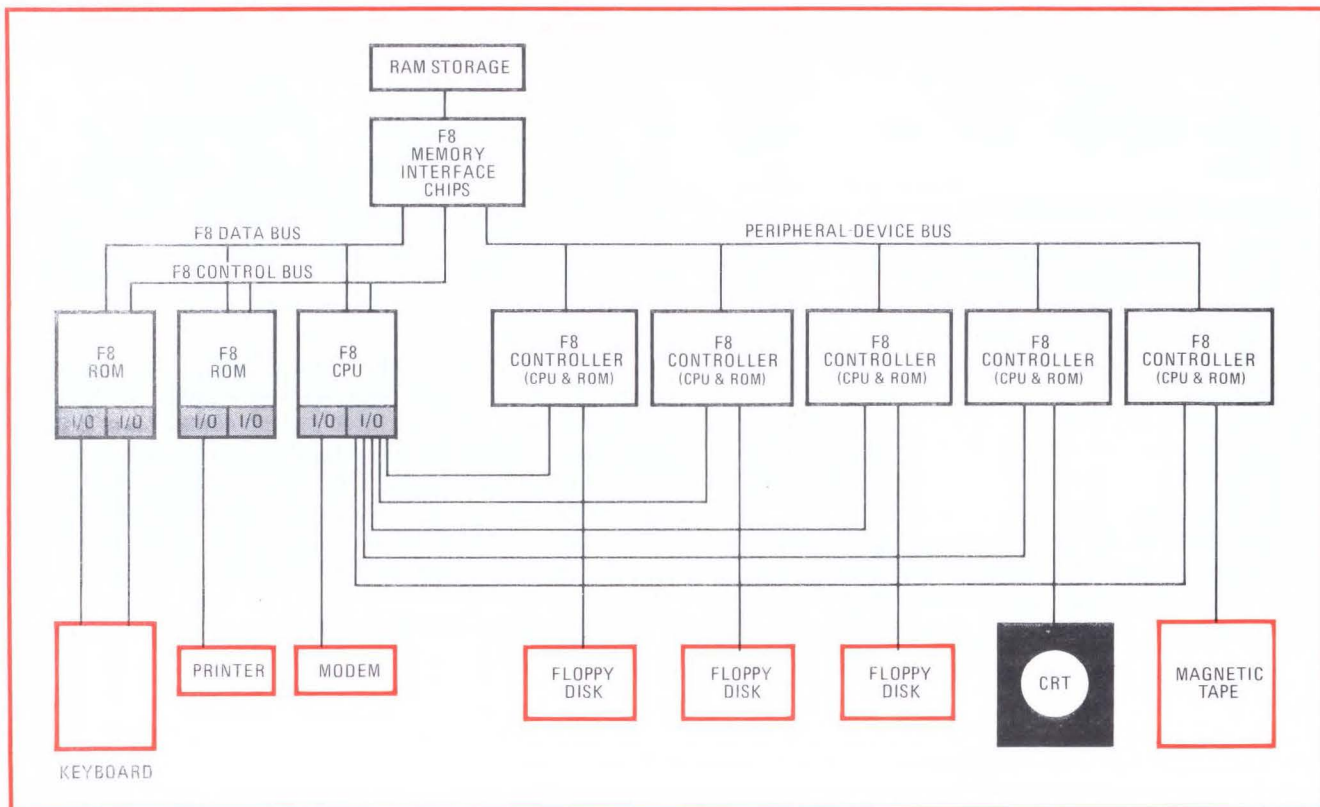

7. Shared memory. In a key-to-floppy-disk system, a single random-access memory can be used by several F8 CPUs and ROMs through the F8 memory-interface chips. Information bandwidth is wide enough to handle more than the three floppy-disk units shown here.

Independently, with no waiting for the operation of another microcomputer (although general instructions are issued by the coordinator). Only three microcomputers are shown, but more can be added to handle more complex subjects. The only limit on the number that can be added is the bandwidth of the common RAM storage, which is set at 1 byte per microsecond. The coordinator microcomputer has priority access to the common RAM storage. Its maximum access time is 0.5 byte/ μ s, leaving the remainder of the bandwidth, 0.5 byte/ μ s, for the other (user) microcomputers.

A multiprocessing system can be set up in which specific tasks—secondary storage, diagnostics, computation, communications, and so on—are divided among the various microcomputers, working from one RAM storage unit. Such an arrangement can exploit the “mail-box” concept to enable the coordinator CPU and other microprocessors to transfer data among themselves in an orderly fashion with minimal hardware. The mail box is simply a set of locations in the common RAM storage reserved for data addressed to specific microcomputers and peripheral devices. After the coordinator writes in the mail box, it uses the interrupt line to get the attention of the selected unit.

Another technique is to assign subtasks rather than complete functions to each microcomputer. A subtask could be control of a complete subsystem, such as a floppy disk or a CRT, or it could be an algorithmic processor. In this modular system, all subtasks are carried out as part of a total program which is controlled by the coordinator.

Figure 7 shows a specific application of the multiprocessing concept as applied to a keyboard-to-floppy-disk system. Possibly this is the most cost-effective way of implementing this system, conservatively costing less than 50% of a conventional implementation. This system involves concurrent operation of three floppy disks, magnetic tape, CRT, keyboard, printer, and modem. While the low-speed devices (the keyboard, printer, and modem) can be adequately handled by the programmed I/O structure, the high-speed devices (disks, magnetic tape, and CRT) require separate F8 CPUs and ROMs.

This scheme provides simplicity of control, modularity, and freedom to expand. In this case, the units operating concurrently are: one magnetic-tape unit (25 μ s/byte); three floppy-disk units (32 μ s/byte each); and a CRT unit (71 μ s/byte). This combination requires an aggregate bandwidth of 0.1478 byte/ μ s—well within the F8’s 0.5-byte/ μ s bandwidth.

However, the F8 chips can be structured into many multiprocessing systems quite different from the common RAM storage type of Fig 7. In a large point-of-sale system, for example, the peripheral devices, such as magnetic wands, optical wands, label readers, and printers, require controllers that can be provided with F8 two-chip systems. The POS terminal itself can also be produced with a medium-size F8 system. With the exception of the corporate EDP system, the F8 can be cost-effective for the entire POS system. □

Acknowledgement

The author is grateful to Thomas Longo for his leadership in developing the Isoplanar n-channel MOS process and the system partitioning used in the F8.

All 10-turn pots look alike

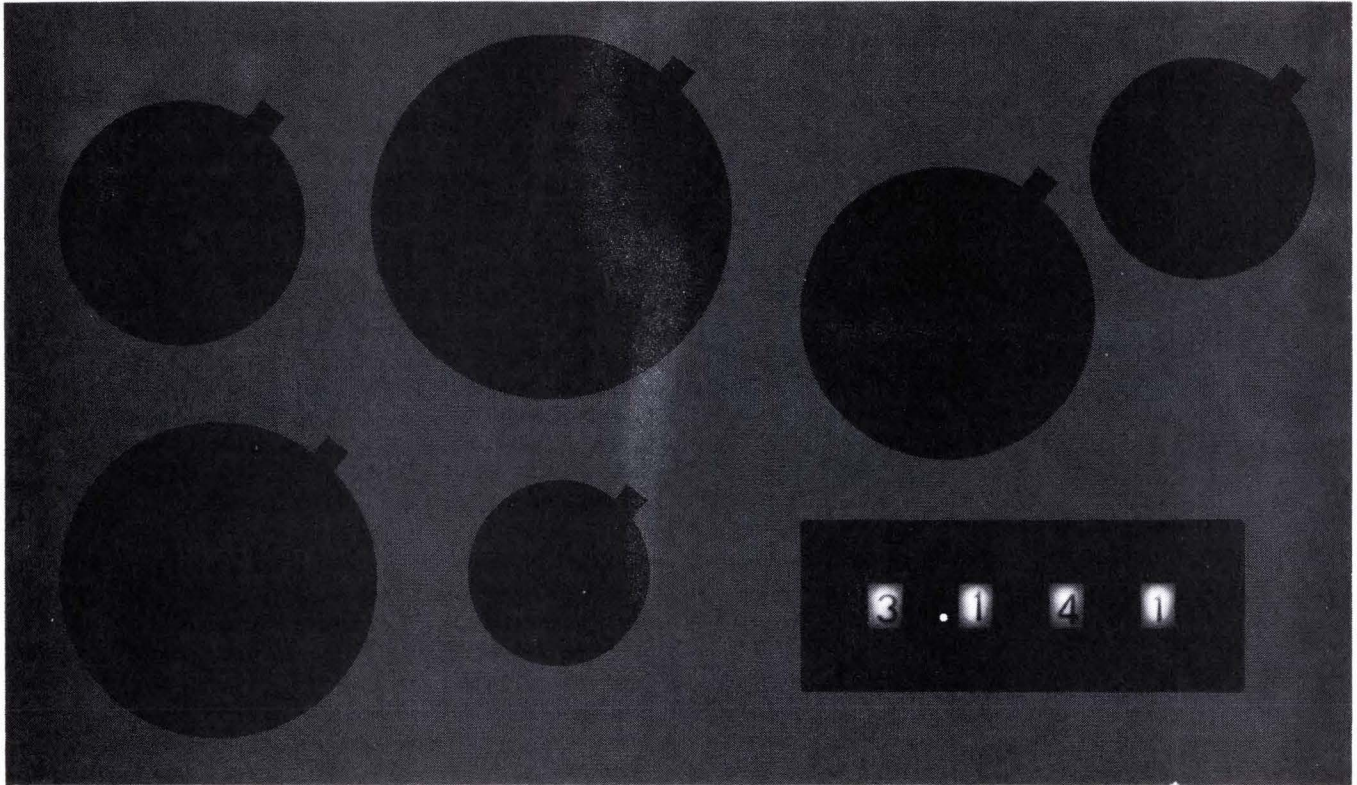

in the dark.

In the dark they're all unreadable. And if you're more than three feet away, you can't even read them in the light.

Ergo our new Thumbpot. It can be illuminated to read in the dark (above), and the numbers are large enough to read 10 feet away.

In addition you can set in those numbers rapidly with finger or thumb. And you can reset any number right on the button, exactly.

The reason for these superior features is that Thumbpot is not a pot. It is an incremental voltage divider. A switch. A switch specifically designed



to replace panel-mounted 10-turn pots.

Because Thumbpot is really a switch, it affords some other advantages. It is available in two sizes, with 1, 2, 3 or 4-digit readout, with or without a fixed or floating decimal point, in more than 400 standard versions. And its design is inherently more reliable and longer-lived than that of 10-turn pots.

There's much more to Thumbpot than we can cover here, however, so we urge you to request our brochure, by mail or telephone.

Thumbpot. No look-alike.

EECO

FOR SWITCHES

1441 East Chestnut Avenue, Santa Ana, California 92701
Phone 714/835-6000



Also available from Hall-Mark



G. S. Marshall



Schweber

One-chip fm demodulator needs no alignment

by J. Brian Dance
University of Birmingham, England

A complete i-f amplifier and demodulator for an fm receiver uses a single integrated circuit that requires no inductors or alignment, and it avoids use of tuned circuits by employing a phase-locked loop. With a 1-kilohertz modulating frequency and 75-kHz deviation, the input sensitivity is about 9 microvolts for a 30-decibel signal-to-noise ratio at 10.7 megahertz. The audio-output voltage is 280 to 480 millivolts, and total harmonic distortion is 0.4%. However, this demodulator won't operate satisfactorily when the input signal contains spurious frequencies, because any beat frequencies formed with the local oscillator signal or its harmonics are fed directly to the phase-locked loop and may pre-

vent the circuit from locking onto the desired signal.

The IC used in this circuit, an NE563, contains a high-gain limiter that amplifies the incoming 10.7-MHz signal before the latter is mixed with a crystal-controlled local-oscillator voltage. The resulting difference frequency, typically 900 kHz, drives the phase-locked loop. If the maximum frequency deviation of the incoming signal is 75 kHz, the reduction of the signal frequency in this way increases the relative maximum deviation from about 0.7% to more than 8%. This 10-fold increase in relative deviation improves signal-to-noise ratio and increases output-signal amplitude.

In the circuit diagram (Fig. 1), an incoming signal from the receiver's front end is fed through C_1 to the input of the high-gain limiter at pin 7. The input impedance is 135 ohms. The signal, amplified by as much as 60 dB, is taken from pin 5 to the filter F. This filter is a standard 10.7-MHz ceramic filter (Toko, Vernitron, or Murata). It must be connected on each side to a circuit with impedance of about 330 ohms; otherwise, its band-pass characteristic will be adversely affected. The limiter's output impedance at pin 5 is about 270 ohms, so

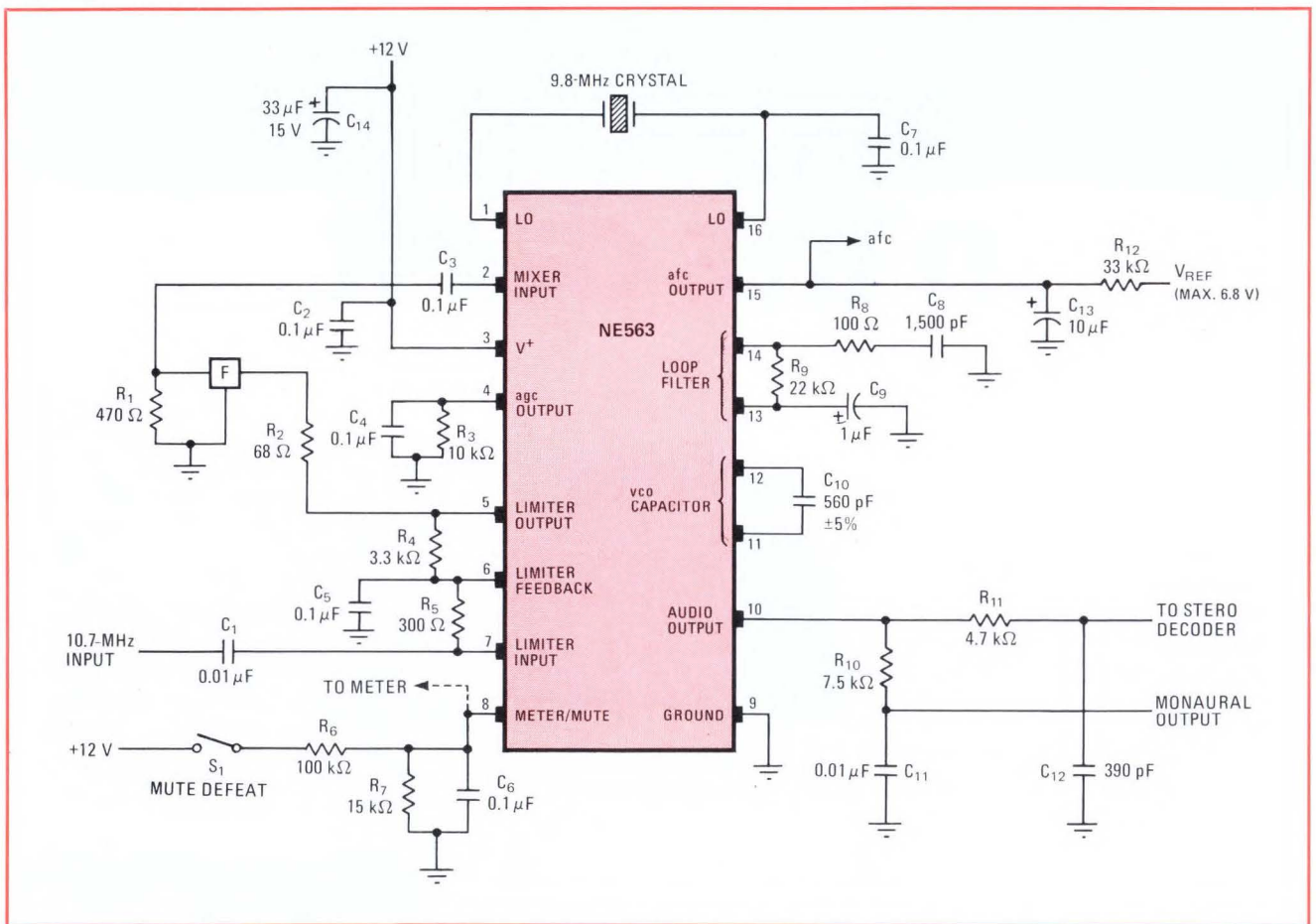

1. An fm demodulator. Single IC is heart of this i-f amplifier and demodulator for fm receiver. The NE563 IC uses phase-locked loop to replace inductors, tuned circuits, and alignment. Resistors, capacitors, ceramic filter, and local-oscillator crystal are only external components; crystal can be replaced with ceramic resonator if preferred. Input sensitivity is about 9 μ V for 30-dB signal-to-noise ratio.

the value of R_2 should be about 68 ohms. Similarly, the mixer's input impedance at pin 2 is about 1,250 ohms, so the value of R_1 in parallel should be 470 ohms.

The 9.8-MHz crystal, connected between pins 1 and 16, is part of the local-oscillator circuit. The 900-kHz difference frequency is fed internally to the phase-locked-loop section of the NE563. The free-running frequency of the loop is determined by C_{10} ; it is desirable that this capacitor have a tolerance of about $\pm 5\%$.

The bandwidth is controlled by the loop filter connected between pins 13 and 14. The filter's output impedance is typically 6.2 kilohms. If R_9 is reduced in value, the bandwidth, and hence the noise level, is reduced.

The low-pass filter, consisting of R_{10} and C_{11} , provides the normal deemphasis. C_{11} should have a value of 0.01 microfarad for use in the U.S., where the deemphasis time-constant is 75 microseconds. For use where the required time constant is $50 \mu s$, C_{11} should be 0.0068 μF . The filter formed by R_{11} and C_{12} , with time constant of $1.8 \mu s$, attenuates radio frequencies before the signal is fed to the decoder.

The limiter circuit feeds the stage that provides automatic gain control from pin 4. The potential at pin 4 remains at about 2.7 volts until the input signal exceeds about 600 μV , and then falls with increasing signal level until it becomes fairly constant at about 0.65 v for inputs exceeding 20 millivolts.

The limiter circuit also provides muting current to pin 8, where the output impedance is about 20 kilohms. The audio-output stage is switched to the muted state when the potential at pin 8 falls below about 1.1 v. A signal of reasonable strength will raise the potential of pin 8 above this value, as will the closing of switch S_1 under any signal conditions. If desired, S_1 , R_6 , and R_7 may be replaced by a 47-kilohm potentiometer between pin 8 and ground to provide a variable muting-level control. Alternatively, if muting is not required, pin 8 may be left unconnected.

A voltmeter of fairly high impedance, connected from pin 8 to ground, will indicate the signal strength; the meter's deflection is proportional to the logarithm of the signal strength, but the calibration depends on whether mute-defeat switch S_1 is open or closed.

The phase-locked loop drives the automatic-frequency-control circuit, which provides a typical output swing of 1.5 v for a 200-kHz increase. This afc output is superimposed upon the steady potential at pin 15.

The circuit in Fig. 1 can be used at frequencies other than those shown. The limiter bandwidth is about

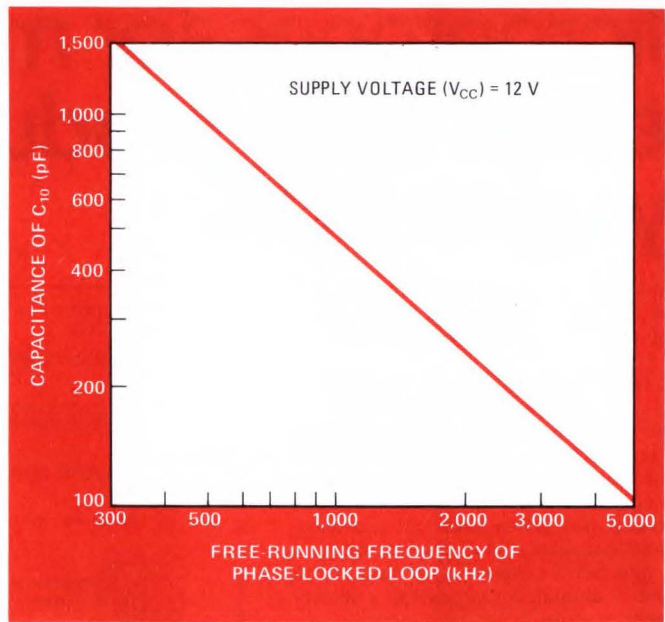

2. Loop frequency. Free-running frequency of phase-locked loop is determined by capacitor C_{10} . Plot shows value of capacitor for various values of free-running frequency. This frequency must be close to the difference between the incoming-signal frequency and the local-oscillator frequency if signal capture is to occur.

22 MHz at -3 dB, and the phase-locked loop itself can operate at frequencies from less than 1 kHz to several megahertz. The value of the voltage-controlled oscillator capacitor (C_{10}) that should be placed between pins 11 and 12 for various free-running frequencies is plotted in Fig. 2. It is obviously necessary to ensure that the free-running frequency is close enough to the input frequency of the loop for capture to occur.

To avoid the cost of the crystal, the circuit of Fig. 1 can be operated with a Taiyo CR-9.8 ceramic resonator. This resonator is connected between pins 1 and 16 in parallel with a 2.2-kilohm resistor and a 5-pF capacitor. The capacitor C_7 is omitted. Satisfactory results are obtained, but the value of the parallel capacitor is fairly critical if oscillation at spurious frequencies is to be avoided. Such oscillations produce a distorted output and may even prevent the wanted signal from being received at all.

The circuit requires a power supply of 10 to 15 v at a current of about 38 mA (42 mA maximum). This current is enough to make the device feel warm to the touch. Some drift of the center frequency occurs for about a minute after the power is first applied. □

Monolithic IC simplifies dc-to-dc converter design

by D.H. Treleaven and A.D. Moore
Microsystems International Ltd., Ottawa, Canada

Battery-powered calculators and digital voltmeters use low-power dc-to-dc converters to obtain from the fewest possible batteries the voltages their logic circuits need. With the converter described here, a single battery of 5 to 10 volts can be made to yield an MOS-compatible output of 18 volts at currents up to 40 milliamperes.

Designed around a monolithic integrated circuit that consists of a zener diode voltage reference, a compara-

Microprocessor modules cut design time, production costs by up to 80%

Pro-Log's microprocessor modules are the hottest item around for use in dedicated control and data processing applications.

What is a microprocessor module?

By using large scale integration, a number of semiconductor manufacturers have made chips containing the central processor units used in small computers. These chips are called microprocessors.

Pro-Log has taken these microprocessors and coupled them with memory, a clock, and flexible input/output circuitry to produce a unique device called a microprocessor module.

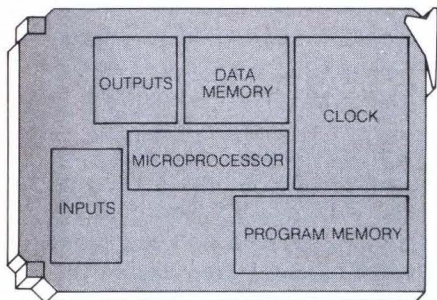

Where can it be used?

Microprocessor modules can be used in two general areas, dedicated control and data processing.

The dedicated control function is now being largely performed by hard-wired logic. Examples include calculators, pinball and slot machines, electronic cash registers and scales, test equipment, stoplights, medical monitoring systems, machine and process controllers . . . in fact almost any situation in which a man interfaces with a machine.

Data Processing applications are now most often handled by computers. Examples include record handling, accounting, inventory control, scientific analysis . . . wherever large volumes of varying data have to be manipulated and evaluated.

How it saves time and money

A microprocessor and a programed PROM working in unison can replace large numbers of logic gates and timing elements. This also eliminates the sockets, power supplies, packaging, connectors, and wiring associated with hardwired logic. By decreasing the number of parts and interconnections in your product, you lower assembly and rework costs, improve reliability and cut inventory, making microprocessor modules a real cost-effective method of performing dedicated control and data processing. As a rule of thumb, if your circuit design calls for the use of more than 50 chips, a microprocessor module can probably do the job for less money.

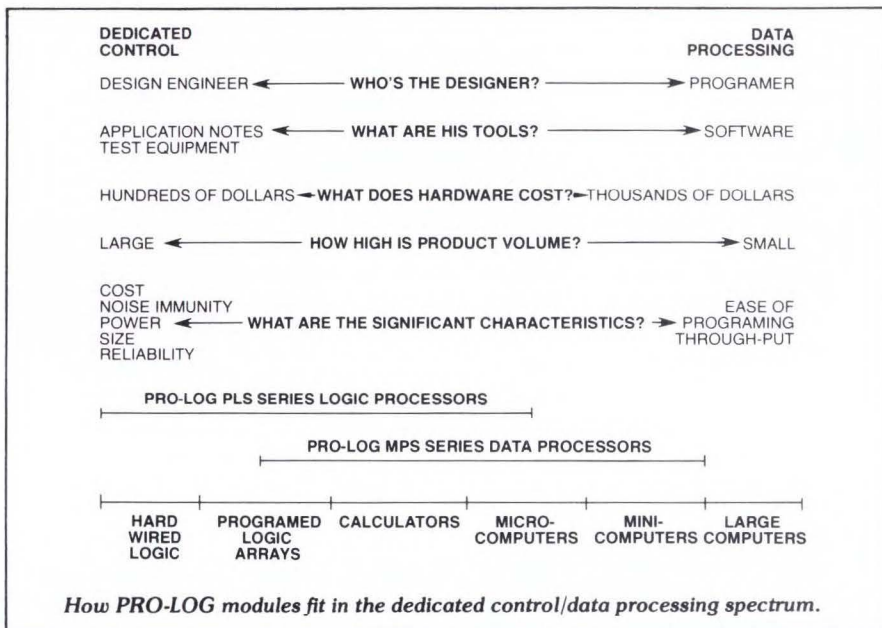

Since microprocessor modules are relatively simple, service calls become less expensive. And you spend less money and time in educating service engineers in system repair.

With our microprocessor modules, and test equipment, there's no need for design engineers to learn traditional programing techniques. It's not necessary to use assemblers, simulators, or compilers to arrive at working hardware.

Through the use of microprocessor modules, most companies realize savings of 60% to 80% over old-style designs.

Only Pro-Log offers a complete package

- Hardware**—logic processor cards, microcomputer cards, interface cards, peripherals, boards, card racks, connectors, sockets, power supplies, and memory modules.

- Instruments and test equipment**—PROM programers and systems analyzers for engineering and field service.

- Education**—Pro-Log offers microprocessor courses nationwide: a one day applications course tells how to evaluate microprocessor modules; a three-day hands-on course teaches how to design, program and use microprocessor modules.

- Application notes.**
- Designer manuals.**

For product information, circle number 215.

For information on applications courses circle number 216.

For information on design courses circle number 217.

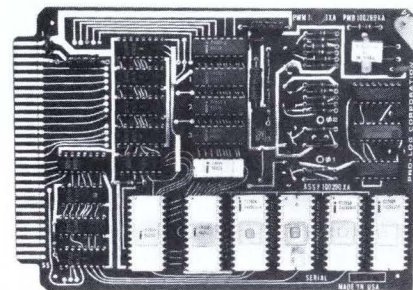

Shown above: Pro-Log's PLS-401 microprocessor module for dedicated control. Price \$355.

Shown below: Pro-Log's MPS-803-1 microprocessor modules for data processing. Price \$810.

OEM and volume discounts available on both.

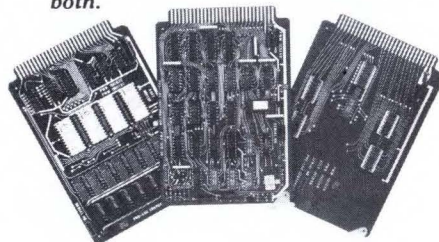

PRO-LOG CORPORATION



852 Airport Road
Monterey, CA 93940
Telephone (408) 372-4593
Bedford, Mass.,
(617) 275-1220

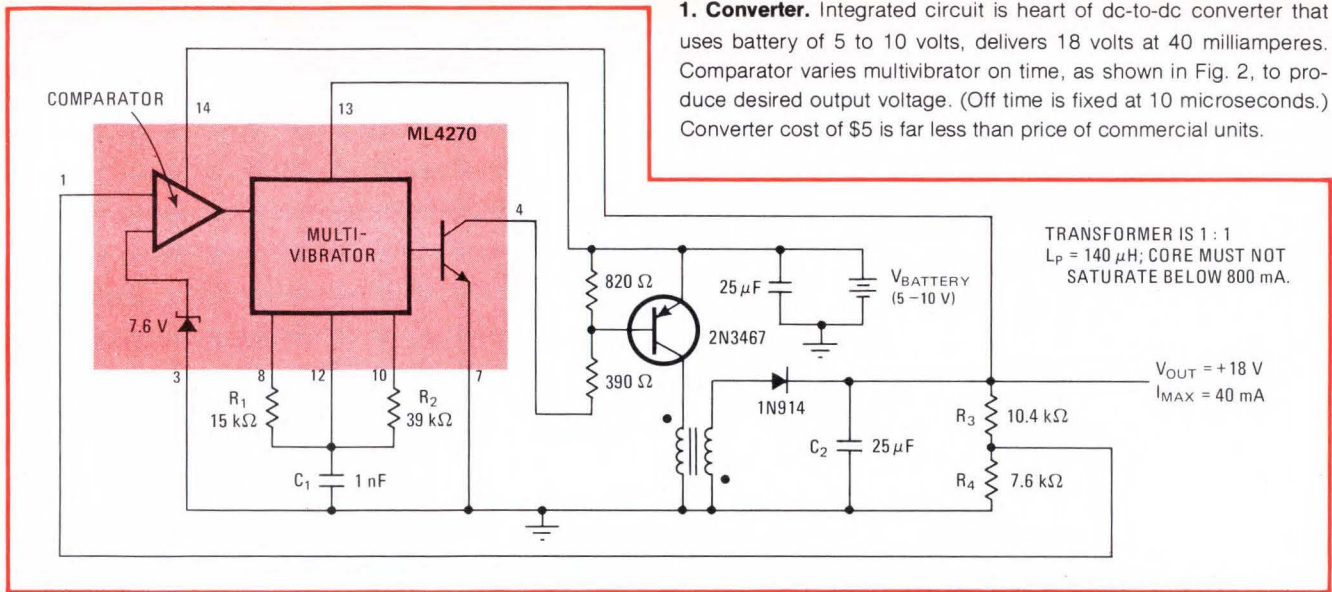

1. Converter. Integrated circuit is heart of dc-to-dc converter that uses battery of 5 to 10 volts, delivers 18 volts at 40 milliamperes. Comparator varies multivibrator on time, as shown in Fig. 2, to produce desired output voltage. (Off time is fixed at 10 microseconds.) Converter cost of \$5 is far less than price of commercial units.

tor, a multivibrator, and an output current switching transistor, the cost of the entire converter is about \$5. Equivalent commercial units now cost about \$30.

The circuit diagram (Fig. 1) shows that the battery is the supply for both the IC and the 2N3467 external power-booster transistor. The on-chip transistor and the booster transistor are switched on and off by the multivibrator. When the transistors are on, the 1N914 switching diode is reverse-biased so that primary current and therefore energy are built up in the transformer. When the multivibrator turns off, the collector of the booster transistor flies low. The anode of the switching diode therefore flies high, causing the diode to conduct; and the energy stored in the transformer is transferred to output filter capacitor C_2 , which in turn supplies the load.

The scope-trace photographs in Fig. 2 show voltage waveforms at the anode of the 1N914 switching diode. While the multivibrator is on, the anode is reverse-biased. When the multivibrator turns off, the anode voltage first flies high, and energy is transferred from the transformer to the output capacitor. Then the open-circuited primary and secondary of the transformer start ringing with stray capacitance, producing damped oscillations in the anode voltage.

The multivibrator is off for a period of $0.7 R_1 C_1$ (which is 10 microseconds here), independent of the battery voltage. It is on for a period of time controlled by the comparator, up to a maximum value of $0.7 R_2 C_1$. The two inputs to the comparator are the 7.6-volt zener reference voltage, and the voltage-divider voltage, $V_{out} R_4 / (R_3 + R_4)$. The comparator varies the multivibrator mark/space ratio to equalize these two voltages, so that

$$V_{out} R_4 / (R_3 + R_4) = V_{ref} = 7.6 \text{ volts}$$

or

$$V_{out} = 7.6(R_3 + R_4) / R_4 \text{ volts}$$

The output voltage has a minimum value of 7.6 v, and its maximum value is limited only by the usual power considerations—the available load current is inversely

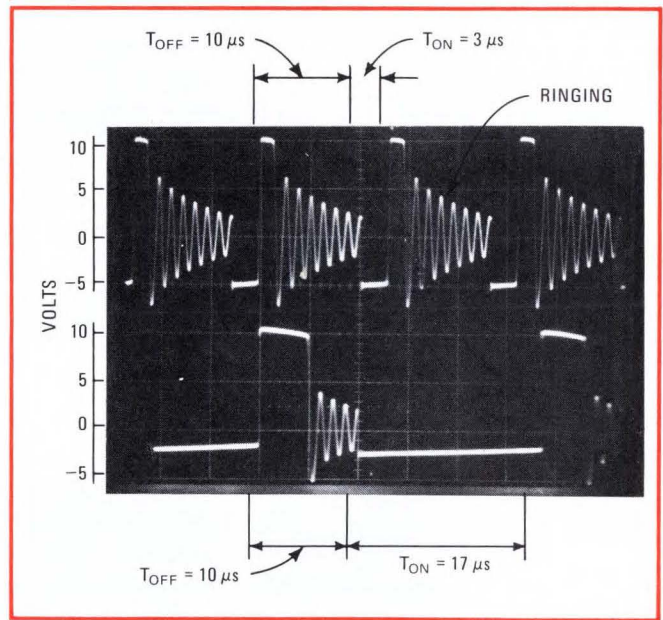

2. Waveforms. Scope photographs show voltage at anode of 1N914 switching diode as multivibrator turns transistors on and off. Top trace: 10-volt battery, 3-milliampere load current, short on-time. Bottom trace: 5-volt battery, 40-mA load current, long on-time.

proportional to output voltage. For the circuit shown in Fig. 1, for example, if R_3 were changed to 1.4 kilohms, the output would be 9 v with a maximum load current of 80 mA.

The converter shown in Fig. 1 has an efficiency of 65%, a load regulation of 10 mV/mA, and a line regulation (i.e., a change of output voltage with battery voltage) of 90 mV/V.

The on-chip output transistor can drive the transformer directly for circuit output powers of up to about 150 mw, and in many applications a simple inductor can be used in place of the pulse transformer. □

Engineer's Notebook is a regular feature in Electronics. We invite readers to submit original design shortcuts, calculation aids, measurement and test techniques, and other ideas for saving engineering time or cost. We'll pay \$50 for each item published.

Now's the time to start cashing in on C-MOS

All you system designers, take note: you don't have to pay a premium for low-power, easy-to-use C-MOS family devices any more—you can now buy all that desirable noise immunity and high tolerance to power-supply variations for nearly TTL prices. **In fact, prices of standard C-MOS parts have dropped so sharply in the last six months**—often to about 15 to 20 cents per gate—that in some cases they are even lower than some MSI TTL parts. And there are now over 10 established C-MOS suppliers offering compatible circuits.

Computer time-sharers unite

If you use time-shared computer services, or design equipment for the time-shared market, or are a vendor of time-shared services, you might be interested in joining a **new nonprofit organization called the Association of Computer Time-Sharing Users**. It's less than a year old and has about 400 members. The association publishes a newsletter and is planning a series of benchmark **programs that will evaluate the services offered by time-sharing vendors**. Write to ACTSU, P.O. Box 663, Parkersburg, W. Va. 26101, for more information.

TI's TV talks on microprocessors

Some details have come through on those half-hour seminars on microprocessors that Texas Instruments is holding on early morning television [*Electronics*, Jan. 23, p. 26]. **The four-part series will be shown on April 15-18 in 20 cities** and will start at 6 a.m. in Chicago (channel 9), Los Angeles (ch. 11), and the Bay Area (ch. 11); at 6.20 a.m. in Boston (ch. 7), and at 6.30 a.m. in the New York area (ch. 5).

A pin-by-pin account of the 4-k RAM

On the market there are now **five different 4,096-bit RAMs with three different package pin counts and four different system operations**, not to mention eight or 10 "dash" parts selected for speed and power consumption. But life wasn't always this complicated.

The Intel 22-pin random-access memory, introduced in June 1972, was first, followed by a TI design with 22 pins but different pin-outs. **When Intel chose to adopt the TI package, there was an industry standard 22-pin 4-k RAM—for a while**. Then Motorola and AMI jointly developed their own 22-pin version, and Mostek went its own way with a 16-pin package. There matters briefly stood, with three device types, three package types.

Perhaps because of the TI/Intel clout, most other semiconductor suppliers rushed to develop the 22-pin version, until to many people's surprise Mostek's 16-pin device, although it needed to be multiplexed and its speed was initially somewhat limited, was overwhelmingly endorsed by mainframe and peripheral manufacturers. They simply liked the smaller package and greater board density.

So everyone flocked to a 16-pin design. Fairchild announced the part, as did Motorola, AMI, and Intel. TI, though, announced an 18-pin package that needed no multiplexing and resulted in almost the same board density. Then, **National came in for the first time with its own 18-pin package—but one that's different from TI's**. Intersil and Signetics say they'll also build 18-pin types but are wondering which to source.

And that's where the 4-k stands for the moment. —Laurence Altman

Electrical Engineering

IHM 124-INT

Visit the
Hanover Fair
and you can



make full use of latest developments

More effectiveness of Electrical Engineering in industry, in the community, in commerce, trade and management: that is just what you are expecting from the 1,620 exhibitors at the Hanover Fair. Within the electrical energy processing section, how does one, for example, meet the rising costs of raw materials? When distributing energy, what can be done for smaller units? How do household installations help the craftsman rationalise his work and in the planning of all types of electrical installation? What progress are the lighting, ultrasonic, micro-miniature welding, spooling and winding machine groups making? Electrical Engineering can find answers to these questions and thousands more, in the form of useful, practical, new developments.

One can make a survey at the Hanover Fair. Here it is not just printed on paper, here you can see the progress which has been made, study and have discussions with experts. Make full use of this compact and accurate information, that only the Hanover Fair can offer you. Make certain that all the new ideas and trends are transferred to your own field and put into action.

Electrical Engineering Plants and Equipment

Electro-machines
Transformers
Static Power Converters
Primary and Secondary Sources of Current
Power Capacitors
High Voltage Switchgear
Low Voltage Switchgear
Wires and Conductors
Cable
Cable-Line Equipment
Electro-Mechanical Processing
Electro-Welding and Soldering
Electro-Thermal Processing
Electro-Chemical and Electro-Physical Processing
Electrical Plants and Equipment for Production and Industry

Electrical and Electronic Instrumentation and Automation

Individual Units
Equipment and Systems
Apparatus and Equipment (according to measuring methods)
Apparatus and Equipment (according to measuring quantities)

Electrical Fittings, Household Installations,

Electronic Entertainment
Installation Devices
Household Appliances

Radio, Television and Gramophones
Receiving Aerials
Electroacoustic Equipment and Accessories
Audio-visual Devices and Equipment for Commercial Use

Electronic Components

Active Components
Passive Components
Electro-Mechanical Components
Component Sub-assemblies

Information which cannot be
obtained elsewhere

starting on Wednesday 16. 4.

**Hanover
Fair '75**
April 16-24,

Lamps, Lighting

Lighting
Incandescent (Filament) Lamps
Discharge Lamps

Telecommunications

Telephony and Telegraphy
Radio Communications
Signalling and Security Control
Timing Devices

Conferences — Meaningful Complement to the Display

Trade conference deepen and intensify the quality of information obtained at the Hanover Fair. For your particular field the following event has been planned: "ETG Conference 1975".

General theme: Small and miniature motors.

Organisers: Energietechnische Gesellschaft im VDE, Hannover, together with the Messe-AG.

Dates: Tuesday 22. 4 and Wednesday 23. 4. 75

The complete conference programme and registration documents can be ordered.

Contact the Deutsche Messe- und Ausstellungs-AG, D-3000 Hannover-Messegeleände, Tel. (0511) 8 91, Telex 09 22 728, for the list of exhibitors and any further information you may require.

ISSCC special report: Bipolar moves up to LSI

The increasingly large-scale integration of both bipolar logic and linear circuitry is today's most significant new trend; also noteworthy is the fastest-yet 4-kilobit MOS RAM

by Laurence Altman, *Solid State Editor*

□ From being a forum for the exchange of circuit ideas among designers, the annual International Solid State Circuits Conference in Philadelphia has also by now become an oracle of new product development. The ISSCC papers over the last five years have made prophetic reading. In them appeared the earliest accounts of the 1103 random-access memory, the first three-transistor-cell 4,096-bit RAM, the first charge-coupled image sensor and analog delay line, the first integrated injection logic circuit, and a monolithic 12-bit digital-to-analog converter—all highly significant product innovations.

That's why the meaning of this year's conference is being carefully analyzed not only by computer and equipment manufacturers who are waiting for new component designs but also by semiconductor makers,

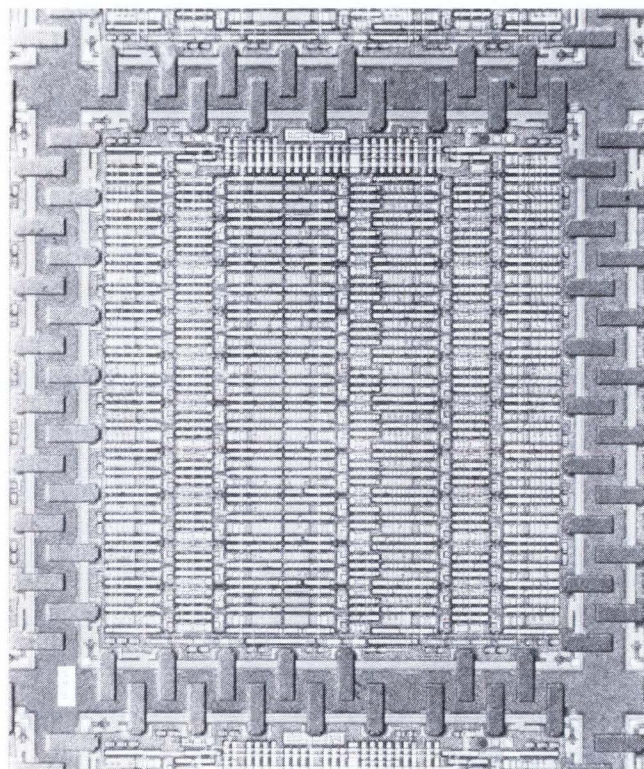

1. The push to bipolar LSI logic. This beam-leaded 100-gate logic array from Motorola uses single-element-per-gate structures called complementary constant current logic. It's part of the growing trend towards low-cost low-power bipolar LSI processors.

who are wondering which of the several new technology approaches to invest in.

And the message is hard to mistake: LSI techniques are moving past MOS technology into the realms of higher-performing bipolar logic and linear integrated circuits. What's more, this new LSI thrust will cut costs and bring the same prosperity to these regions that it once brought to MOS LSI.

The LSI payoff extends over all product lines:

- Single-element gates, using some form of injection or current-managing logic, are pushing bipolar logic toward the 10,000-gate-per-chip regions. Coupled with such speed-boosting techniques as Schottky output clamps, they promise high-performing logic for the next round of computer design.

- A 4,096-bit MOS random-access memory, designed around the novel 7001-type charge-pump technique, has an access time of less than 80 nanoseconds. This 4-k device has no rival in today's memory spectrum and heralds the arrival of cheap, very fast main memories.

- LSI circuits for digital filtering will eliminate expensive multipackage filtering systems, ushering in an era of cheap filters for commercial as well as consumer equipment. At the same time charge-coupled and MOS analog filters have reached the hardware stage for the tough, expensive, and complex operations—Fourier transforms, recursive filtering, analog signal delay—needed in telecommunications and military systems.

- New linear LSI techniques answer the need of data-acquisition system designers for cheap, accurate converter components. Here, matched LSI linear chips partitioned into 12-bit digital-to-analog converters perform as well as the best modular units but at a fraction of the cost. Equally significant are analog-to-digital converters that are fabricated by mixing MOS or I²L digital circuits in with the traditional bipolar linear elements on the same chip. And new designs could replace the expensive resistive ladder with a simpler-to-make capacitive network.

The new LSI—fast because bipolar

The consensus at this year's conference was that bipolar LSI logic is the hottest topic in semiconductor design. So rapidly, in fact, has the design pendulum swung towards it that 2- and 4-bit bipolar processor slices are already on the market. Four bits is about the limit of these designs, however. Depending as they do on more-

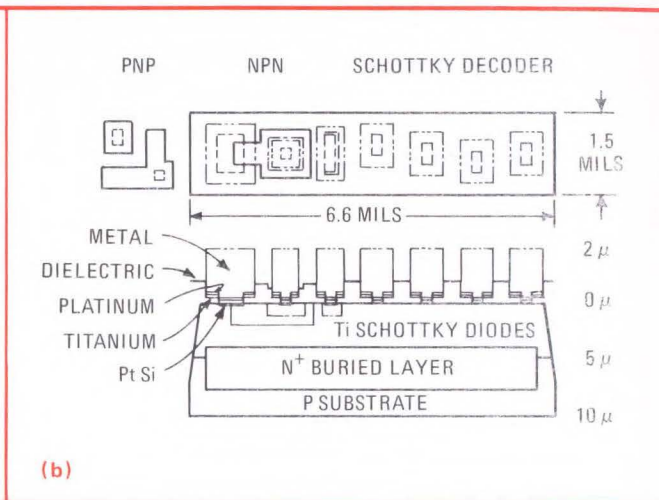
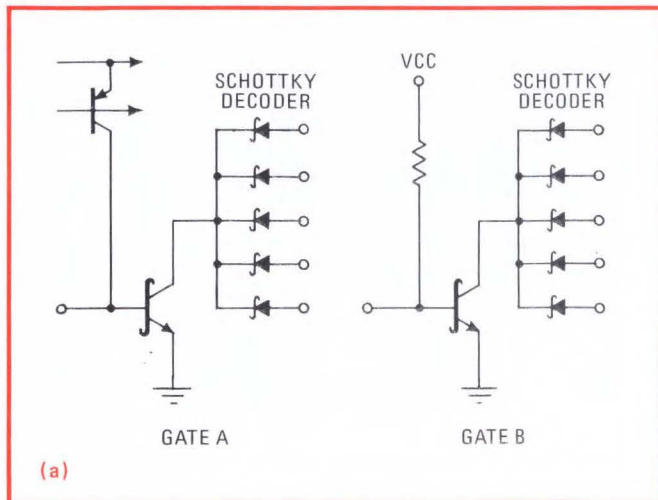

2. Schottky speed. Performance of injection-type gates is boosted by Schottky outputs. In Motorola's C³L gates (a) either a complementary pnp or resistor-limited current source can be used. In either case gate collapses to less than 13 mil² with passive isolation.

or-less standard Schottky TTL and ECL, beefed up with ion-implanted elements like shallow emitters and low-resistance bases, they are not expected to rise above 1,000-gate level required for a 4-bit LSI processor.

What triggered discussion at ISSCC was the 1,000- to 10,000-gate level of complexity. And the bipolar technology most amenable to that degree of LSI is some form of integrated injection logic, which is very dense and consumes very little power—its speed-power can be as low as 0.5 picojoule.

The trouble is that, in its standard configuration, I²L is capable of only moderate speeds—20 to 100 nanoseconds, which fall well far short of TTL's 2 ns or 5 ns. To boost speed, therefore, designers are turning to some form of injection-current management on the gate input and some form of Schottky clamp to dampen the logic swings on the output.

This dual approach is adopted by Motorola in the 100-gate beam-leaded array shown in Fig. 1. The array is built with an injection-like complementary constant current logic (C³L) which, like I²L, is a modification of the old direct-coupled logic technique. The gate structure is fairly complex—it has a form of current routing on the input and a series of Schottky devices on the output—but even so, all the circuitry for a single gate fits in the area of a single transistor, just as with I²L.

Figure 2a illustrates how a pnp current-source transistor and a complementary npn switching transistor are fabricated in the same small isolation region. The use of passive polysilicon isolation around active circuit elements allows nearly 1,000 C³L gates to fit on a 130-square-mil die, and speeds of 3 ns at 1 millivolt per gate and 100 ns at 0.01 milliwatt per gate can be attained.

Figure 2b shows two basic C³L gate types. Type A has a bussed pnp constant-current source that can operate from a 1.5-volt supply, and type B uses a more conventional resistor-limited current supply. In both cases, low-threshold Schottky diodes form the input AND function, which is then inverted and amplified by a single transistor.

In the Motorola scheme, which was designed by a team led by Arthur W. Peltier, the Schottky diodes are

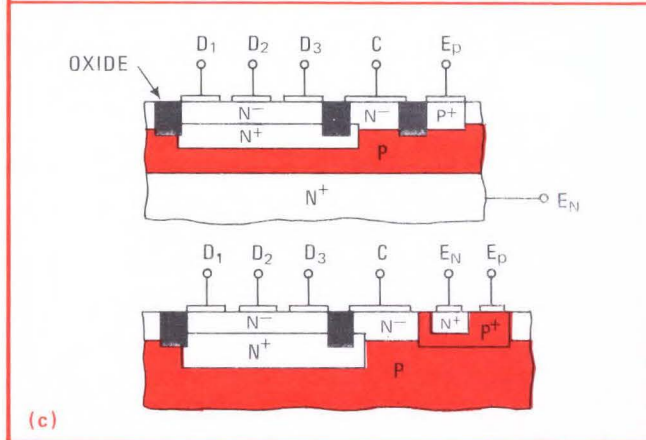
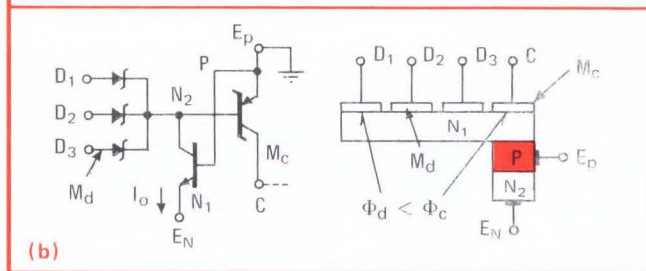
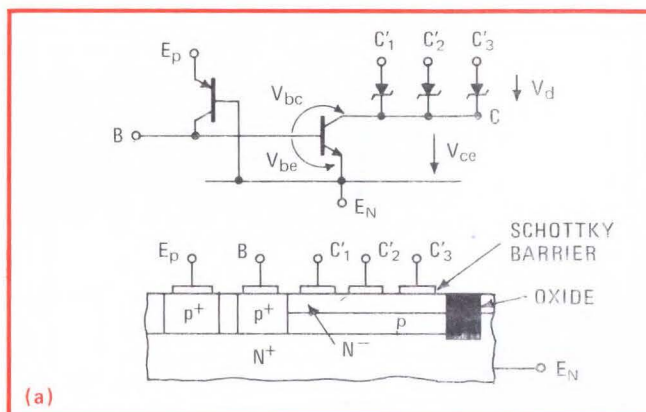

3. Schottky I²L. Logic swings in IBM's I²L gates are reduced and speed enhanced with Schottky clamps (a). Little extra space is needed because clamps can be integrated on collector region. A true Schottky transistor may reduce gate to three active regions.

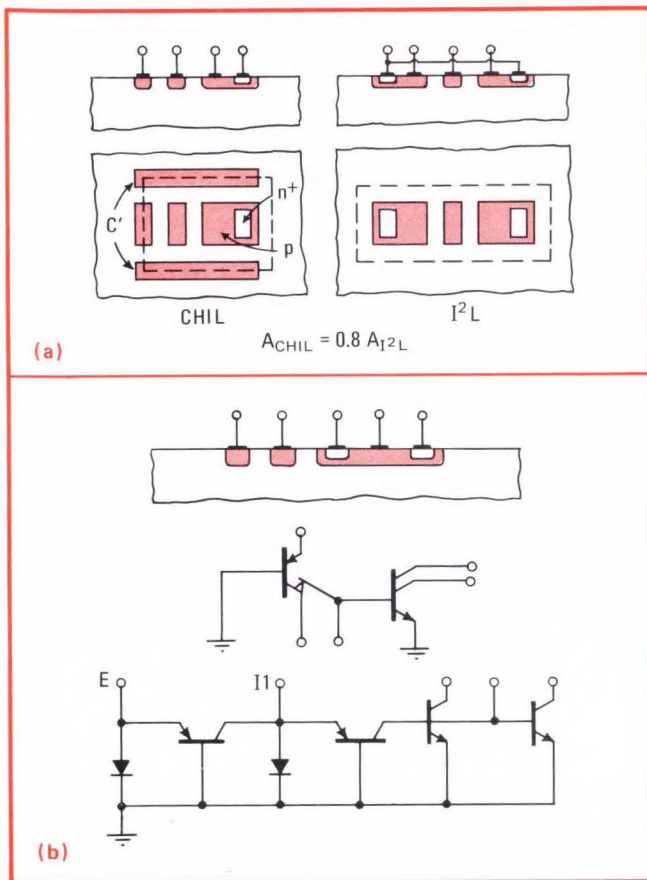

4. Current hogging and I²L. Current hogging increases the usefulness of injection logic by enabling designers to build multi-input gates. Siemens' two-input I²L gate (a) is actually smaller than one-input gate. NAND gate circuit (b) shows flexibility.

formed right in the collector region of the driving gate's npn, so that they occupy very little chip space. The base lead of the driven gate is then routed across the collectors of the gates that perform the input function. To operate, the Schottky diodes need forward voltage levels between the 750-mV collector-to-emitter voltage on the Schottky clamped npn. This requirement is satisfied by the use of a titanium, tungsten, and titanium-tungsten alloy metal system.

To carry out a logic operation with this gate structure, current is steered to the Schottky clamped element from either the pnp or the resistor connected to the base of the npn. If at least one driving gate is on, the current passes through that gate's decoding Schottky diode and output npn to ground. A voltage of 0.4 to 0.5 V results at the npn's base, holding the driven gate off. When the last driving gate npn turns off, the driven gate's current is steered into the base of the output npn, turning it on.

Like Motorola's C³L researchers, circuit designers Horst Berger and Siegfried Wiedmann of IBM Laboratories, Boeblingen, West Germany, are using Schottky clamps in the outputs of their I²L circuit structures (Fig. 2a). Here gate speed is increased because the Schottky diodes reduce the logic swings from the usual 700 mV to 150–350 mV. This allows one to envision I²L gates operating with the desired 2- to 5-ns propagation delay.

The IBM scheme wastes little space on the Schottky

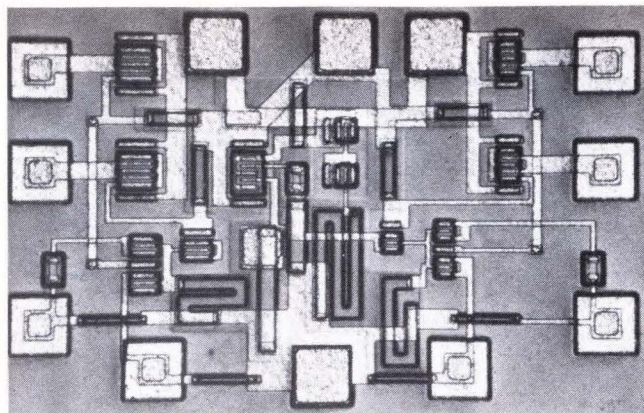

5. Enhanced ECL. ECL gates with ion-implanted transistors achieve subnanosecond speeds. This Siemens gate, which has oxide-isolated transistors made with boron-implanted bases and arsenic-implanted emitters, operates below 0.5 ns.

clamps, the n⁻ collector of the npn transistor being used to integrate them into the structure (Fig. 3a). Adding an ohmic contact to this collector region also makes it possible to interface I²L gate directly with a TTL gate, increasing the structure's flexibility for circuit design.

Would you believe pure Schottky?

Looking further ahead, Berger and Wiedmann have suggested using a genuine Schottky collector and actually replacing one of the active semiconductor regions with metal. This novel type of metal-collector transistor (designated pnm, with the m standing for metal) would result in a very elegant gate design (Fig. 3b). The structure would need only three active semiconductor regions, packed into no more space than a single bipolar transistor, yet it would perform as well as a Schottky TTL gate occupying 100 times the space. But the pnm device must of course be equivalent to the conventional pnp transistor it replaces and will require some new processing techniques if it's to avoid being leaky.

Another major drawback of conventional I²L gates is that they're limited to one input each—a fan-in inflexibility which causes difficulties in circuit layouts, especially for LSI designs of 1,000-gate complexity. To combat the problem, a current-hogging scheme developed at Siemens AG, Munich, Germany, doubles the number of inputs per gate at no penalty in circuit area (Fig. 4a).

In this two-input injection logic gate, the npn transistor turns off when a low voltage (less than 300 mV) is applied to either of the inputs shown. But if both inputs are turned off, the output transistor will be on because current hogging has taken place between the emitter and collectors of the lateral pnp transistor. Thus, this current-hogging I²L gate is functionally similar to the standard I²L inverter except that the input current on the injectors is controlled, allowing more than one input per gate. A NAND gate built with this technique is shown in Fig. 4b. Siemens researcher Rüdiger Müller contends that this dual-input structure results in an area saving of 20% over equivalent I²L structures, and 300% over standard current-hogging logic.

Paralleling the development of bipolar LSI is the acceleration of conventional logic speeds into the low sub-

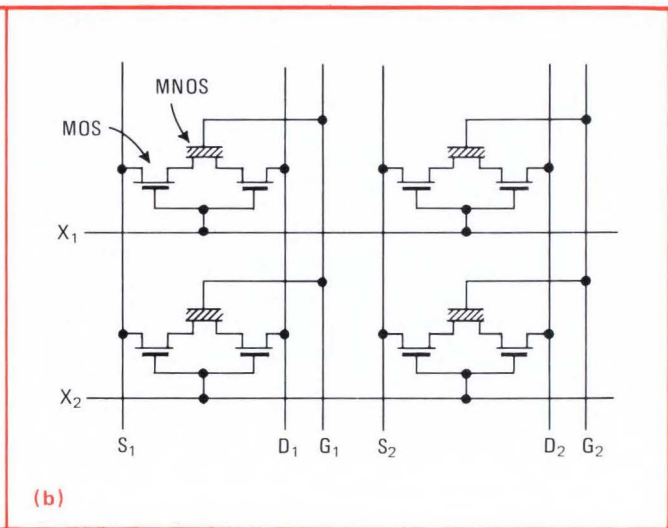
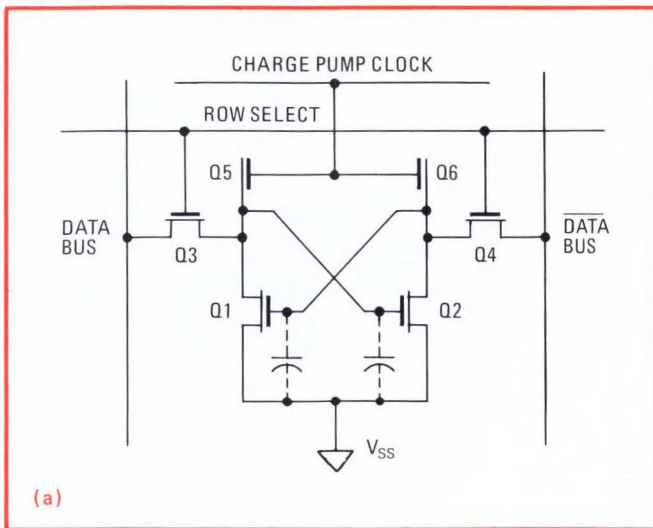

6. Two types of RAM cells. Cell belonging to Intel's ECL-compatible 4,096-bit 80-ns memory is a four-transistor dynamic type made static-like with charge pumping (a). Toshiba MNOS cell has nitride gates for nonvolatile operation (b) but requires a writing voltage of -35 V.

nanosecond range. This advance is achieved through fully implanted emitter-coupled-logic transistors with micrometer-deep emitters, low-resistance bases, and minimal collector capacitance.

The double-implanted ECL gates built by Siemens, for instance, operate at as low as 0.4 ns. Siemens designer Jurgen Graul built the transistors by implanting boron in the base and arsenic in the emitter. Oxide isolation also reduced the structure's capacitance by creating a highly efficient oxide-walled base collector and base contact.

The resulting gate is shown in Fig. 5. It has a power-dissipation range of 10 to 100 milliwatts and is about 50% faster than a conventionally diffused control structure. Propagation delay at a speed-power product of 2 picojoules is 0.7 ns and for all-out speed can drop to less than 0.5 ns at a higher (4-pJ) speed-power value.

Memories remain MOS

If bipolar devices captured the logic limelight at Philadelphia, metal oxide semiconductors continued to star in memory design. Of the many new memories shown at the conference, two were outstanding—a 4,096-bit 80-ns n-channel MOS RAM aimed at fast mainframes and a 1,024-bit nitride-fabricated MNOS RAM aimed at nonvolatile memory systems for consumer and industrial use.

Intel designers who developed the fast 4-k RAM continue to impress observers as the industry's major innovators in MOS memory design. Their latest feat was to use the tough-to-build static-seeming charge-pump principle in a viable 4-k memory (although the chip is a big 204 by 237 mils). What's more, they managed to make the device inputs and outputs fully compatible with standard 10K ECL, in recognition of the fact that fast mainframes generally operate with ECL controllers.

The problem of channeling low ECL inputs into high-level on-chip MOS clocks was solved by designing a high-gain latched differential amplifier on the chip to serve as the clock buffer. Using a dc stabilization loop to

divide dc levels very precisely, both chip enable inputs then serve as differential inputs from the ECL driving gate to maximize the small (less than 600 mV) differential input clock levels. Low-pass filters remove transients during switching, while conventional bootstrap clock drivers generate all necessary internal clock levels.

The basic storage cell (Fig. 6a) is the four-transistor dynamic cross-coupled type that's familiar from its use on the 7001 1,024-bit RAM. Data is stored as charge on the gates of Q_1 or Q_2 and sustained by charge pumps Q_5 and Q_6 , but in an extension of the 7001 technique, the pumps from all cells are referenced to an oscillator built on the chip. This design is impressive because the unique ion-implanted charge pump can operate from a clock voltage that even at its lowest level is positive with respect to the substrate potential. Conventional pumps require a clock voltage that is more negative than the substrate potential and is difficult and costly to obtain.

Also unique is the cell structure of the 1,024-bit MNOS RAM (Fig. 6b). To write a 0 into the nonvolatile cell requires a voltage of about -35 v that causes the threshold voltage of the selected MNOS transistor to shift in a positive direction. Likewise, a 1 is written into a cell when it is negatively biased so that the selected MNOS transistor is shifted in the negative direction.

The device with this cell structure was developed at the Toshiba Research and Development Center in Kanagawa, Japan. Organized as 1,024 words by 1 bit, it operates from a -12 -v and -5 -v ground power supply and has an access time of 600 ns, a write cycle time of 10 to 100 microseconds, and a write power dissipation of about 600 mV. Although slower and much more power hungry than today's dynamic nonvolatile RAMs, this nitride structure can hold charge indefinitely. It could therefore open up memory applications in such areas as point-of-sale terminals, automobiles, and remote sensing equipment that are less suitable for today's volatile semiconductor memories.

Although CCD imagers and memories still get most of the product publicity, CCD analog-signal processing

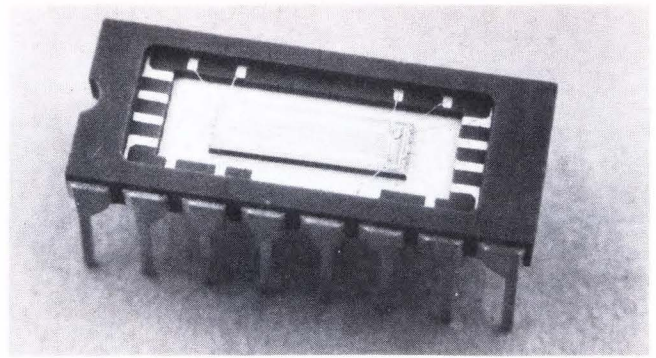
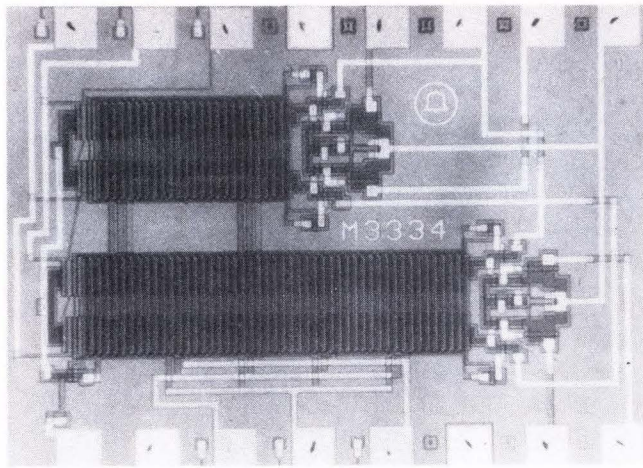

7. Analog filtering. Two approaches are being pursued. Bell Labs recursive filter uses CCD techniques for efficient two-register operation (left). The Reticon's 128-element analog-signal-processing device is built with plain silicon-gate MOS technique (right).

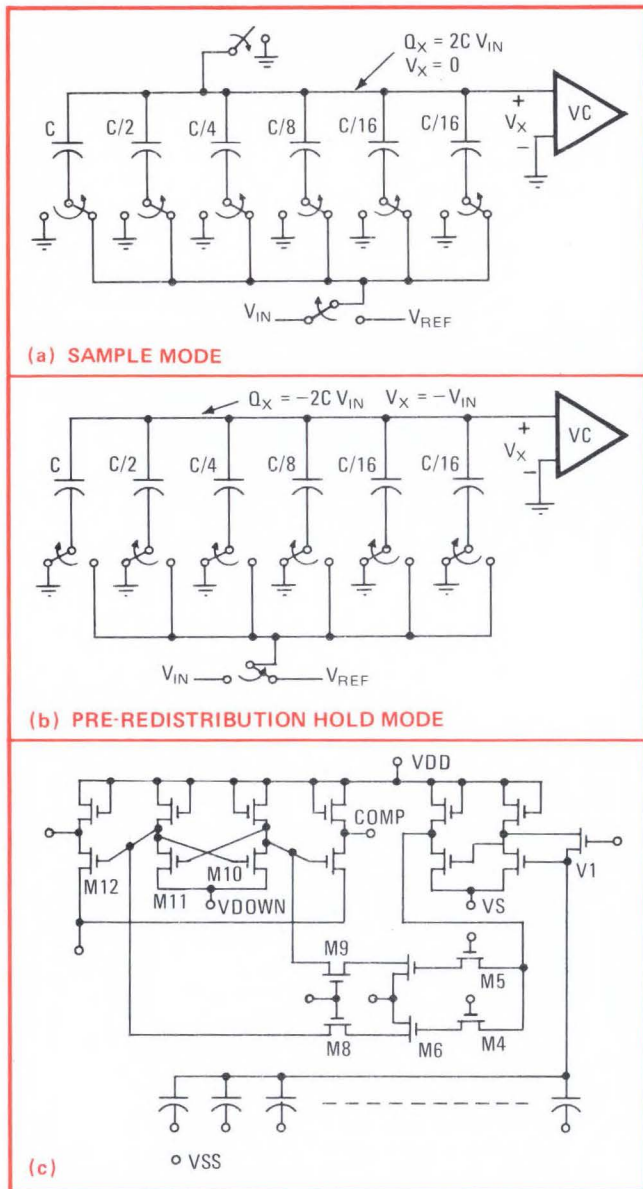

8. No need for resistors. Researchers at Berkeley replace the resistive ladder with an MOS capacitor network to obtain current division in a 10-bit analog-to-digital converter. A 5-bit segment of the network is shown in (a) and (b), the entire circuit in (c).

components are beginning to make an impact on equipment design, especially in the telecommunications and secure military communications industries. This is because the complex filtering and delay needed by these systems are difficult to handle with conventional methods, requiring either many expensive analog components or expensive computers.

CCDs and the analog filter

Bell Labs developers, who realized early on that CCDs were a good LSI solution to many of their system delay and filtering needs, have disclosed one of their filtering devices—an experimental recursive filter element that could be useful in equalization networks, bandpass filtering, and other telephone delay-line applications (Fig. 7, left). The device has two registers—one with 24 elements and one with 48—that share common three-phase clocking and analog input signals. As the analog signals are multiplexed through their respective lines, they are delayed by unequal amounts and then recombined for the required delay functions.

Bell device specialists Dave Sealer and Mike Tompsett designed the filter with many features that simplify its operation. For example, the problem of surface errors has been relieved with a surface potential equalization technique. Also, pick-up noise and temperature instability, both of which are problems with conventional filters, are reduced by separate channel in each line that acts as a differential circuit.

A more general-purpose analog-signal process is Reticon Corp.'s 128-element device (Fig. 7, right). Built with the company's self-scanned MOS technology—a standard p-channel silicon-gate process that's more established than the CCD processing—it should reach the marketplace shortly. Operation is straightforward. An analog signal is sequentially sampled by a two-phase dynamic shift register. New analog information is read into the device by being loaded one bit at a time into a read-in shift register, through which it is then clocked. The device normally reads out at a 1-megahertz rate, but 5-MHz operation is possible in a stripped-down version.

LSI and linear design

Although large-scale integration is most visible in digital systems, similar techniques are being applied to

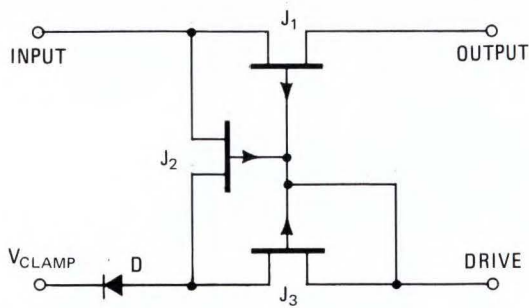

(a)

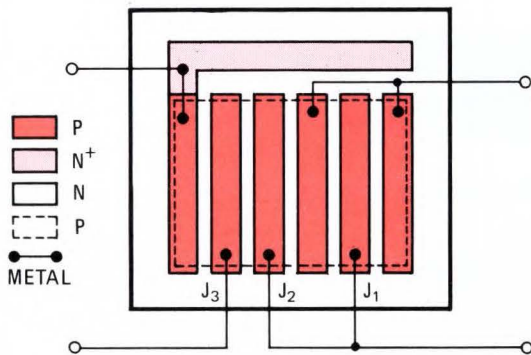

(b)

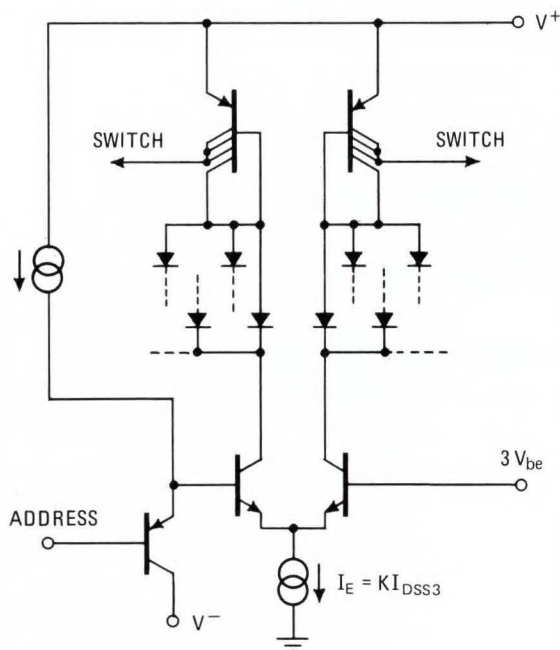

(c)

9. Mixed marriage. Combining a J-FET process with a standard bipolar linear process results in this 8-channel analog multiplexer. Designed by National Semiconductor, the four J-FETs in the switch (a) occupy about the same area as a single transistor (b). For added speed, on-chip decoder has gain-control circuit (c). Multiplexer can switch ± 10 V in less than 1 microsecond, fits in 4,700 mil.²

analog design, most notably in the case of converters. Here, the possibility of adding the necessary logic to the standard linear process promises a dramatic reduction in the fabrication cost. Already a single-chip 10-bit analog-to-digital converter and a two-chip monolithic 12-bit digital-to-analog converter have been built by Analog Devices. In the DAC one chip provides the resistor ladder, and the other contains the analog switches. But the next 12 to 18 months may well see a single chip containing ladder, switch, the required op amp, and perhaps even the necessary voltage reference.

A more radical approach to fast ADC design, developed by researchers at the University of California, uses an MOS capacitor network along with a successive approximation technique and does away completely with resistive ladder. In essence the capacitor array serves the same function as the resistive ladder: it provides the division of the analog input signal.

A five-bit version of the device consists of an array of binary-weighted capacitors, a voltage comparator, and switches which connect the appropriate MOS capacitor plates to the appropriate voltages (Fig. 8a). In this case the capacitors perform the binary voltage division (Fig. 8b) needed to obtain binary fractions of reference voltage. These voltages are then subtracted successively from the input voltage until the digital conversion is accomplished.

A complete 10-bit ADC using this technique is shown in Fig. 8c, where the capacitors have values ranging from 120 picofarads to 0.24 pF, for a total of 240 pF. Clearly the success of this approach depends on how accurately the capacitor ratios can be maintained with today's photomasks. But on the basis of considerable data on experimental structures the Berkeley researchers feel that good yields can be maintained for ± 0.5 -least-significant-bit resolution.

Better standard linears

Finally, the advent of mixed linear processing is already benefiting industrial analog components—operational amplifiers, switches, and multiplexers. For example, National Semiconductor's fast eight-channel analog multiplexer combines a junction-FET switch and bipolar drive circuits with a bias scheme that's insensitive to pinch-off voltage variation. It therefore has high yields and a low manufacturing cost, so that it answers the need for cheaper analog multiplexers to serve as companions to the microprocessors now moving in on data acquisition and control systems.

The eight-channel device, which has a typical on resistance of 200 ohms, can switch ± 10 V in less than 1 μ s and is only 4,700 mil² in area. Its speed and small size are both due to the ingenious design of the J-FET switch circuit, which fits three FETs inside the space normally required by one (Fig. 9a and b). This tight geometry reduces device parasitics and thus enhances speed.

Also contributing to the multiplexer's speed is the on-chip address decoder (Fig. 9c). Here, a controlled-gain configuration is connected to a lateral pnp to guarantee that the transistor will operate near its maximum cutoff frequency. □

If you're worrying about Gallium, you haven't heard the news.

A large stable supply of gallium is now available.

From Alcoa's new plant in Bauxite, Arkansas.

It's already processing Alcoa's own gallium-rich Arkansas bauxite in significant quantities.

So don't worry. Long term availability is here. Enough for major applications . . . from stock . . . as close as your nearest airport.

Keep thinking about electroluminescence, optocoupling, photovoltaic conversion, magnetic bubble memories and other uses of gallium.

Because gallium from Alcoa will stay available.

Gallium is found in bauxite. And Alcoa has extensive reserves of bauxite in Arkansas. So Alcoa will be extracting gallium from Arkansas bauxite for a long time to come.

That's the news.

And there's more. Just write Aluminum Company of America, 850-C Alcoa Building, Pittsburgh, PA 15219.

Change for the better with
Alcoa® Gallium



Microwave counter reaches 18 GHz

Using modified transfer-oscillator technique, instrument measures frequencies in both narrow and wide modes; can be programed remotely

by Bernard Cole, San Francisco bureau manager

For the two primary modes of measuring microwave frequencies—narrow or wide—designers usually depend on two different technologies, transfer-oscillator for the narrow mode or heterodyne-converter for the wide.

Using a modified transfer-oscillator technique called Flacto (frequency-locked automatic computing transfer oscillator), Systron-Donner's Instrument division has developed a microwave counter, the 6054A, that measures in both narrow and wide modes.

The narrow mode is the choice for making high-speed, high-resolution measurements of microwave inputs emanating from stable frequency sources such as microwave synthesizers, multiplied crystal sources or any devices which are phase-locked to high-stability references. The wide mode makes it possible to track and measure signals having high deviation limits, like those that drift rapidly or that contain a lot of power-supply noise.

Priced at \$5,900, the 6054A spans the range from 0.02 to 18 gigahertz, without any range selection. Furthermore, one connector input covers all inputs above 20 megahertz, so that there's no need to switch ranges or make cable changes, says Gail M. Dishong, product manager.

The input sensitivity covers a dynamic range, without any dead zone, of up to 45 decibels—from -15 dBm (up to 12 GHz) and -7 dBm (above 12 GHz) to +30-dBm maximum input level.

With the use of the Flacto technique, says Dishong, the fm tolerance characteristic of the narrow mode is 10 megahertz peak to peak,



regardless of modulation rate—good enough for routine measurements.

In the wide mode the 6054A can handle those unusual cases in which the frequency modulation on the input signal exceeds the fm tolerance of the narrow mode. The peak-to-peak deviation tolerated by the wide mode depends on the fm modulation rate of the signal. For example, in a typical voice-communication signal of 18 GHz, deviations on the order of 500 MHz peak to peak are realized. At power line rates, the maximum deviation is 3.5 GHz peak to peak. Conventional microwave counters cannot measure such signals, says Dishong.

A novel system of visual alarms on the 605A warns the operator of pending overloads that might damage the counter. As long as the input remains below +20 dBm, a green light indicates a normal lock condition. Should the input level exceed the critical point, the green lock light will flash alternately with a red warning light, and the least significant digit of the readout will also start flashing. Measurements can still be made and displayed by the counter right up to its maximum input power level of +30 dBm (1 watt).

To prevent false readings, if the input locking circuit is not activated, the counter yields no display.

In addition to general-purpose test applications on the bench, the 6054A can be programed remotely in single-line format instead of through the switchable controls on its front panel. The 11-digit readout, decimal point, green light and lock lamp are available on the rear panel in parallel 1-2-4-8 BCD format. Over and above the standard stability specifications, which offer ± 1 part in a million per year, the user can specify any of three higher-stability oscillators, including one with an aging rate of ± 5 parts in 10 billion per day.

An extra-cost option provides any of four offset frequencies to be added or subtracted from the display, so that radio-frequencies can be displayed based on local-oscillator-frequency measurements.

The counter weighs 30 pounds, measures 3.5 by 16.75 by 17.5 inches, operates off 115 or 230 volts ac, consumes about 106 w, and operates over a temperature range of 0 to 50° C.

Product Manager, Instrument Division, Systron-Donner Corp., 10 Systron Dr., Concord, Calif. 94518 [338]

Packaging & production

Finding faults on analog cards

Software package extends capabilities of GR's automatic test system

Computer-aided fault location is extended to analog circuit boards by a new software package developed by General Radio Co. [*Electronics*, Sept. 19, 1974, p. 104]. In its digital mode, the package—called the CAPS VII—also can simulate more logic states than previous software, the company says.

CAPS VII can be applied to GR's new logic-board test system, the 1792D, which was designed from the start to handle digital/analog as well as digital boards.

The 1792D digital/analog test system includes a DEC PDP-8E minicomputer, a control panel, a DEC RK8E or Diablo 31 disk drive, a display terminal, and up to 2.4 million words of memory. The CAPS VII software includes a computer-guided probe.

The analog part of the test is not simulated in CAPS VII as the digital part is, but is integrated into the test program layout and is designed to take up a minimum amount of computer space. When a program goes into the analog mode an analog scanner, or switching network, which is never "seen" from the software point of view, automatically connects an analog probe to the desired pin and a reading is taken with a dc-to-digital converter designed by GR. Other testers, the company points out, use conventional bench-top dc voltmeters to take analog measurements, but these measure in binary-coded-decimal, which must be translated to binary coding to be understood by a digital tester. And if the user wishes to program the limits of the analog pin under test, the tester must convert from binary to BCD. GR's converter translates di-

rectly from the original decimal measurement taken in the analog portion of the board to binary, doing the converting in the module and bypassing BCD altogether.

CAPS VII also simulates more logic states than the previous GR software, CAPS VI. CAPS VI could only simulate three logic states: logic 0, 1, and X when it was not known if the output would show a 0, 1, or a clock pulse. CAPS VII can simulate these three states plus S for oscillation, R for critical race when a logic output can be resolved in one of two ways depending on the propagation rate of a signal, and P and N for positive and negative pulse spikes.

Boards which run on CAPS VI will also run on CAPS VII; the language was changed slightly to make CAPS VII work with digital/analog language, but GR offers a program called Convert that will change the software from one language to the other.

Price for the 1792D with the CAPS VII program ranges from \$75,000 for a minimum system to over \$100,000. A user can upgrade to CAPS VII for \$5,900. Delivery time for the 1792D is 10-12 weeks; CAPS VII is available off the shelf.

General Radio Co., 300 Baker Ave., Concord, Mass. 01742 [391]

12 circuit-board testers use Naked Mini computer

Describing the systems as third-generation versions of its Capable series, Computer Automation has introduced 12 test systems for checking circuit boards. The new systems, priced from \$41,900 to \$148,900, range from a simple "depot" tester to a full-blown system for boards with 600 ICs, all logic levels, plus pre-production logic simulation capability. Some versions have analog capability as well as digital.

All models use the Computer Automation Naked Mini LSI-2 minicomputer, with programing compatible among them; all have guided



fault isolation. The smallest system, the 4050, is a test-only machine designed for repair depots and is transportable. It requires a model 4150 or 4350 for program development. The unit can check only TTL and C-MOS logic, and will test boards with up to 384 pins.

The smallest regular nondepot tester is the test-only 4100, which tests TTL or C-MOS boards with under 80 ICs per board. The 4150 has the same features, plus full capability to develop test programs. Like all programing versions, it also includes a CRT terminal. It would usually be the first system acquired.

The models 4200 test and 4250 test and programing systems are similar to the 4100-4150, and they can handle all logic levels.

Top of the line is the 4900, which has the capability of a complete hardware and software system for simulating logic during product development, an ability usually requiring a larger computer. This system also automatically generates test programs for the logic designs. It includes a card reader and line printer in addition to disk storage and a cathode-ray-tube terminal.

Computer Automation, 18651, Von Karman, Irvine, Calif. 92664 [392]

Notched headers are easily broken to desired length

A line of straight and right-angle headers consist of arrays of 0.025-inch-square pins for insertion into printed-circuit boards. They are supplied in notched sticks which can be broken by hand to any desired

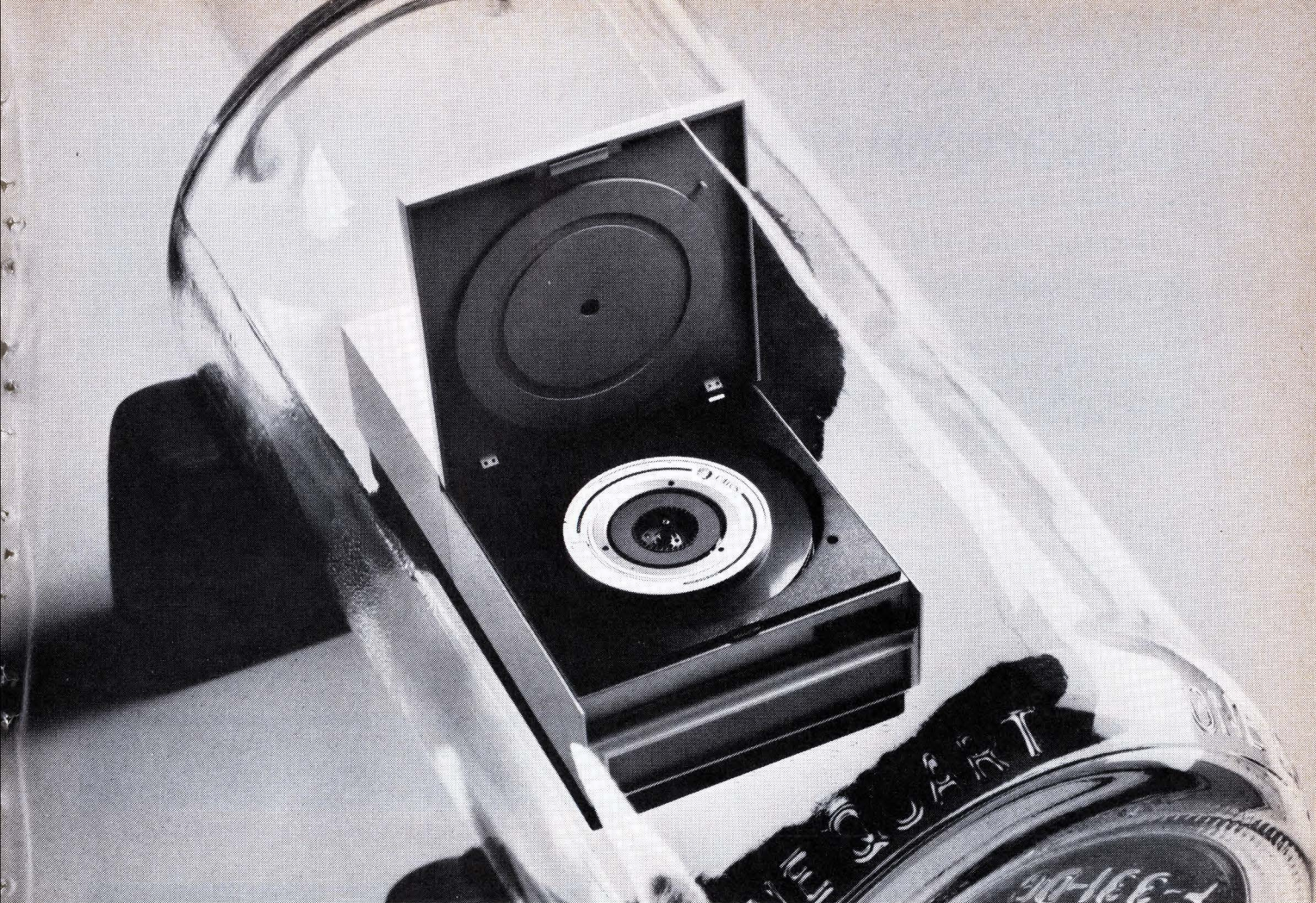

Big technology for Mini-computers.

The mini-computer market has grown to the point where it demands "3330" disk technology in a package that fits.

**Introducing:
The Trident Disk Drives.**

Greater track density helped get us down to size. The new Trident Series brings you 370 tracks-per-inch. And up to 6,060 bits-per-inch. Storage capacities range from 27-82 megabytes.

Designed for the OEM.

The Tridents are each compact, self-contained and rack-mountable.

Their start or stop time is only 20 seconds. Pack changes take less than one minute. Rotational speed is 3600 r.p.m. Track access time is 6 milliseconds.

The Trident Series has one of the lowest cost-per-byte ratios in the industry.

These features make the Tridents easy to buy and easier to sell. Call or write California Computer Products, Inc., EM-M3-75, 2411 West La Palma Avenue, Anaheim, California 92801. (714) 821-2011.



CALCOMP

Heath scopes give you more than you bargain for.

The single trace 4530... a professional service scope

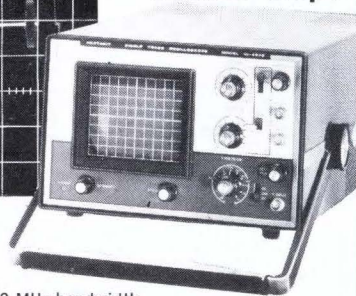
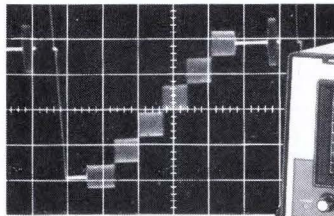

It's hard to find a better 10 MHz scope value than the Heath 4530. It features DC-10 MHz bandwidth, 10 mV sensitivity... trigger bandwidth guaranteed to 15 MHz, AC & DC coupled... TV coupling for service work... time bases from 200 ms/cm to 200 ns/cm... and true X-Y capability. The 4530 is easy to operate and offers a lot of performance for the money. Only \$420.00* for the factory assembled & calibrated SO-4530. Or order the easy-to-assemble Heathkit IO-4530, only \$299.95*

The dual trace 4510... a precision lab-grade scope

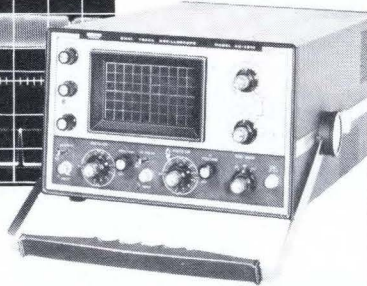
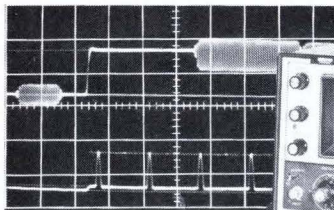

The 4510 is our best scope value — and it's easy to see why. With DC-15 MHz bandwidth... 1 mV/cm input sensitivity... 45 MHz typical triggering bandwidth, 30 MHz guaranteed... time base sweep 100 ns/cm... post-deflection accelerated CRT for high brightness... vertical delay lines for complete waveform display... X-Y capability... operates on any line voltage from 100 to 280 VAC. Assembled & calibrated SO-4510, only \$750.00*. Kit-form IO-4510, only \$549.95*.



For information on all the Heath scopes

... send for your free copies of our latest catalogs. The **Heath/Schlumberger Assembled Instruments Catalog** features a complete line of high performance, low cost instruments for service and design applications. Our '75 **Heathkit Catalog** describes the world's largest selection of electronic kits — including a full line of lab & service instruments.

HEATH COMPANY
Dept. 510-03
Benton Harbor, Michigan 49022

HEATH
Schlumberger

- Please send the latest Heath/Schlumberger Assembled Instruments Catalog.
- Please send the 1975 Heathkit Catalog.

Name _____

Title _____

Company/Institution _____

Street _____

City _____

State _____

Zip _____

*MAIL ORDER PRICES; F.O.B. FACTORY.

PRICES AND SPECIFICATIONS SUBJECT TO CHANGE WITHOUT NOTICE.

EK-451

110 Circle 110 on reader service card

MINI-THUMBWHEEL SWITCH

FOR COMPUTERS.
NUMERIC CONTROLS.
IN-FLIGHT GEAR.
MANY OTHER SMALL-SPACE INPUT SWITCHING OPERATIONS.

RETROFITS MOST MINIATURE THUMBWHEEL SWITCH PANEL OPENINGS.

CDI Series TSM mini-thumbwheel switches mount on 1/2-inch centers... can be furnished with decimal, binary, or binary with complement output—or with specified code characters. Available with extended PC boards for mounting additional components if desired. Large, easily-read numerals... positive detent... 8, 10 and 12 positions. Completely O-ring sealed against hostile operating environments.



.900" x .980"
FRONT PANEL SIZE
FOR SINGLE
MODULE ASSEMBLY.



CHICAGO DYNAMIC INDUSTRIES, INC.

PRECISION PRODUCTS DIVISION
1725 Diversey Blvd., Chicago, Illinois 60614
Phone (312) 935-4600

Circle 144 on reader service card

Kurz-Kasch offers refreshing style

You want refreshing style in your product designs, and when it comes to knobs... that certain look makes all the difference. Send for our FREE catalog of knobs and select your prototype sample to try on your product. There are literally thousands of choices and we can help you decide. You'll settle only for the best. Long lasting beauty, rugged durability and handsome styling. Call or write: Kurz-Kasch, Inc., 711 Hunter Avenue, Wilmington, Ohio 45177. Tel: (513) 382-0966. Or, see our catalog in THOM-CAT.

the Snob Knot People

Kurz-Kasch, Inc.

Circle 145 on reader service card

New products

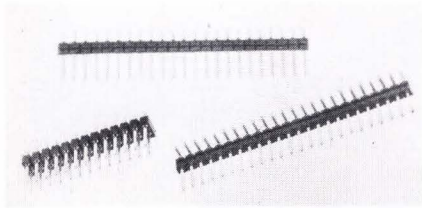

length. Called BergStik headers, the devices represent an inexpensive means for putting wrapped-wire pins onto circuit boards. The manufacturer particularly recommends the headers for boards with low pin populations, in which application they can be inserted without interrupting the flow of assembly-line work. Their installation requires no machinery.

Berg Electronics Division, Du Pont Co., New Cumberland, Pa. 17070 [394]

Linear-IC tester examines wide range of devices

The J149 Linear Circuit Test Instrument is intended mainly for incoming inspection and component evaluation. It performs major parametric tests on such linear circuits as voltage regulators, op amps, and comparators. The instrument uses two plug-in programming boards for each device type: a family board for each major category of compo-



Paper Tape Handler

Model 650

A new low-cost spooler for use with the Addmaster 601 Tape Reader

Fully self-contained, including power supply for reader.

Reads "step by step" on external command or runs on internal clock at 150 characters per second.

Bi-directional, both read and high speed slew mode.

Needs only two control lines.

Stops on character.

Automatic end of tape/broken tape sensing.

Fully proportional servos.

Standard 19" rack mounting, 5 1/4" high panel.

Uses 5 1/4" diameter reels.

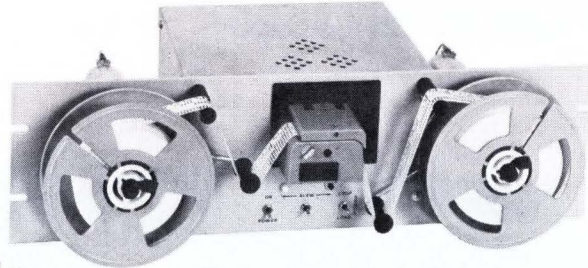

Write for catalog of Addmaster computer peripherals.

416 Junipero Serra Drive • San Gabriel, California 91776

Circle 111 on reader service card

SHAPE FOIL INTO MAGNETIC SHIELDS

in minutes... with scissors... low cost

No waiting. Solves many shielding problems. Use a single formula (ask us) to determine thickness and number of layers. Combine this with practical trial and error. After cutting, hand trim AD-MU foil to the correct outline and fit it around the component to be shielded.

If you need relatively few shields, or are experimenting, that's it. You've eliminated designing, tooling and manufacturing costs for prefabricated shields.

Especially good also for hard-to-get-at places and to make assemblies more compact by placing magnetically reacting components closer together without performance degradation.



Comprehensive 18-page magnetic shielding catalog with 4-page reprint from Electronic Design on request.

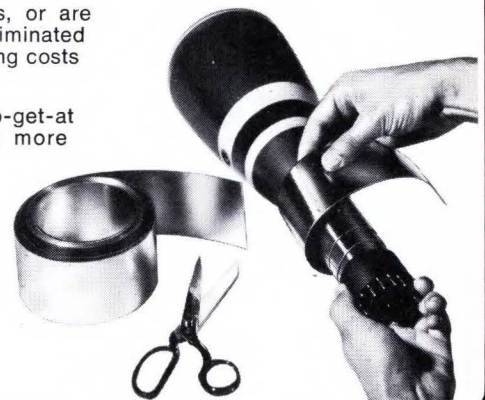

AD-VANCE MAGNETICS, INC.

226 E. SEVENTH ST., ROCHESTER, IND. 46975

(219) 223-3158 TWX 810 290 0294



Our 3rd Decade of Magnetic Shielding Leadership

Keithley's newest

μ volt DMM is...

sensitive . . . (to 1 μ V, 10pA, 1m Ω),
stable. (0.2 μ V/ $^{\circ}$ C),
versatile . . . (26 dc ranges),
economical (\$525)



The Model 160B. It's the epitome of a DMM for scientific and engineering labs. Sensitivities down to 1 microvolt, 10 picoamps, and 1 milliohm are founded on Keithley's lifetime of expertise in designing and building low-level instrumentation.

But the 160B isn't just for super-sensitive measurements. . . it's a rugged, all-around Multimeter too. It measures voltages to 1200 volts, currents to 2 amps and resistances to 2000 megs. Floating measurements to 1200 volts off ground are routine for the 160B which also has Keithley's traditional analog output. And there's a full complement of accessories to enhance the DMM's versatility—rechargeable battery operation, digital output, rf probe, carrying case and many more.

Punishing overloads won't impair the performance of this reliable DMM either. Its overload protection combines with rugged mechanical design to result in a Multimeter capable of handling the abuse that a lab DMM experiences.

The new Keithley Model 160B Digital Multimeter has it all: sensitivity, stability, versatility, economy. Find out what it can do for you. Send for complete literature or phone (216) 248-0400.



**KEITHLEY
INSTRUMENTS**
U.S.A.: 28775 AURORA ROAD, CLEVELAND, OHIO 44139
EUROPE: 14, AVENUE VILLARDIN, 1009 PULLY, SUISSE

New products

ment (such as an op amp), and a device board for each unique device within a family. The J149, including the op amp family board, sells for \$11,900. Other family boards are priced at about \$3,000. Delivery time is 12 to 16 weeks.

Teradyne Inc., 183 Essex St., Boston, Mass. 02111 [393]

Conveyor furnace has controlled atmosphere

A controlled-atmosphere conveyor furnace—the WJ-977 (4CVD-75)—offers manufacturers of liquid-crystal and planar gas-discharge displays an opportunity to do in-house coating of tin oxide on glass. The furnace is equipped with an exhaust system said to make possible safe, pollution-free operation. Used as a transparent conductor on the face plates of displays, tin oxide is claimed to be superior to indium oxide, which is also used for this purpose, in that it is more stable, more scratch-resistant, less subject to pinholes, better adhering, and cheaper.

Watkins-Johnson Co., 440 Mount Hermon Rd., Scotts Valley, Calif. 95066 [395]

Automatic tester

checks relays 13 ways

An automatic relay tester performs up to 13 tests per relay. Included are measurements of coil and contact resistance, pick-up and drop-out voltages, operate, release, and bounce times, four different high-voltage insulation tests, make-before-break and break-before-make checks, and latch-up tests. The system, which sells for approximately \$40,000, can handle up to six-pole double-throw relays at each of its five test fixtures. The price includes installation and a short course in the programming, operation, and maintenance of the machine. Delivery time is 16 to 20 weeks.

Clarke-Hess Communication Research Corp., 43 West 16 St., New York, N. Y. 10011 [396]

Semiconductors

Ion-implanted diodes are fast

Rectifiers rated at up to 100 amperes at 150 volts have 0.45-V forward drops

Not all progress in semiconductors is occurring in MOS and bipolar LSI, as evidenced by a series of 100-ampere, fast-recovery rectifiers made by an ion-implantation process. The units are made by Solid State Devices Inc., which had earlier introduced low-current versions.

The new devices, with peak repetitive reverse voltages to 150 volts, appear to be the first ion-implanted rectifiers in their power range. The implantation process gives the rectifiers properties desirable in clamps and switches, high-frequency switching, miniaturized power supplies, core memories, laser modulators, welders and other applications in which high speed, high current capacity and low forward drop are important. Forward voltage drop is only 0.45 v at 100 A, and reverse recovery time is a maximum of 75 nanoseconds. Average ac reverse leakage is 5 milliamperes, but special low-leakage devices are available.

The rectifiers are single-chip, planar, epitaxial units that are fully passivated. The usual packaging is in hermetic TO-3 cans (diamond transistor packages) or in DO-5 stud packages, but both chips and devices mounted on molybdenum studs with flying leads are available for hybrid applications. The construction makes them suitable for this, unlike ordinary unpassivated mesa rectifiers, says company president Arnold H. Applebaum.

Ion implantation provides close control of doping, with impurities concentrating in a region just a few hundred angstroms below the device surface. This thin junction region cannot store carriers, hence the

fast recovery times. Since the process eliminates the need for gold for speed, the devices have good radiation resistance.

The 100-A, 150-v rectifier in the TO-3 package, which has a thermal resistance of 0.5°C per watt, is priced at \$50. The company also makes a 75-A version, and has plans to market 200-A devices. Applebaum says the process can be used for any size diode, up to full two-inch wafers good for 3,000 A.

Solid State Devices Inc., 14830 Valley View Ave., La Mirada, Calif. 90638. [411]

12L microprocessor comes in four-bit slices

The first microprocessor built with integrated injection logic has been formally introduced by Texas Instruments. It's a 4-bit-slice micro-programmable unit that can be operated in parallel to implement 4- to

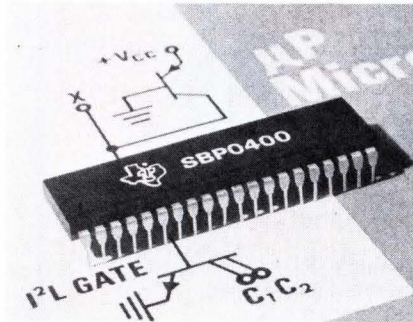

16-bit systems. Although not yet in full-scale production, the SBP0400 is being sampled throughout the industry. It has a complexity of more than 1,450 gates—easily the most complex chip built to date from standard bipolar logic [*Electronics*, Feb. 6, p. 83].

It's also one of the easiest to use because of its full carry-look-ahead capability and its use of a factory-programmable logic array (PLA) which contains 512 standard single-clock-length operations. The unit is particularly undemanding in its power-supply requirements: any dc supply that can provide a nominal power of 128 milliwatts at a voltage of at least +0.85 volt will do.

The microprocessor element has a constant propagation-delay/power-consumption product. Each can be selected over a range of five orders of magnitude at the expense of the other. At the nominal 128-mw power level, typical propagation time in about 300 nanoseconds.

Presently available engineering versions of the SBP0400, designated the X0400N, are housed in 40-pin plastic dual in-line packages and sell for \$90 each in 1- to 24-piece quantities. Production devices in both commercial (0 to 70°C) and military (-55 to 125°C) temperature versions are planned for later announcement.

Texas Instruments Inc., Inquiry Answering Service, P. O. Box 5012, M/S 308, Dallas, Texas 75222 [412]

Instrumentation amplifier drifts only 5 $\mu\text{V}/^\circ\text{C}$

The gain of a new monolithic instrumentation amplifier can be programmed accurately from 0.1 to 1,000. The amplifier has a maximum input offset drift of 5 microvolts per degree Celsius (1.5 $\mu\text{V}/^\circ\text{C}$ typical) and a maximum output drift of 150 $\mu\text{V}/^\circ\text{C}$ (50 $\mu\text{V}/^\circ\text{C}$ typical). The AD521K sells for \$18 in unit quantities, and the more loosely specified AD521J is priced at \$12.75. In lots of 100, these prices drop to \$12 and \$8.50, respectively. The amplifiers have a minimum common-mode-rejection ratio of 110 dB at the worst-case gain of 1,000 and with a 1,000-ohm source-impedance imbalance from dc to 100 Hz. Furthermore, since the units are true instrumentation amplifiers, not op amps, they do not depend upon the matching

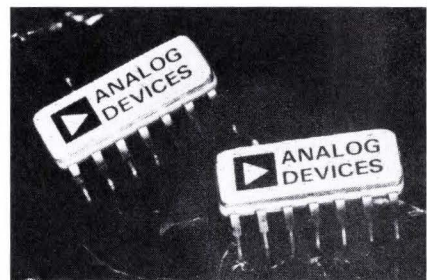

REG MC 3M
 BENDI
 A LOCKHEED
 XEROX

If you want fluxless soldering with ultrasonics—call us! These Top 500 companies did.

Ultrasonic soldering system handles fluxless soldering of regular metals, exotics, glass and ceramics.

G-35 generator delivers 35 watts of ultrasonic heated power into soldering iron. Push button controlled power levels of heat and sound energy. All solid state circuitry. Auto-feedback, power tracking.

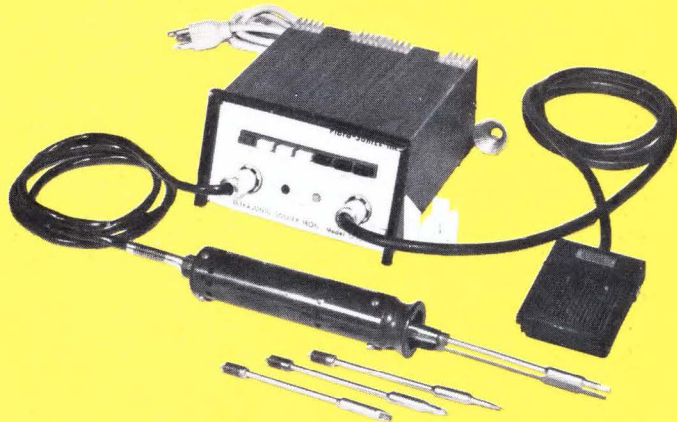

For a free confidential evaluation, send samples of your materials and description of your requirements to Fibra-Sonics. They will be returned at no cost or obligation.

FIBRA-SONICS®, INC.

4626 N. Lamon Avenue/Chicago, Illinois 60630/(312) 286-7377

For more information, circle 239 on reader service card.
 To have a representative call, circle 240 on reader service card.

Cost Cutter

NEW Electronics Buyers' Guide...

Easy-to-use, single volume source for:

- Data on over 4,000 products
- Over 6,000 company listings and phone numbers.
- **EBG EXCLUSIVE:** quick access to over 1000 catalogs through a Direct Inquiry Service. The international world of electronics at your fingertips. Find suppliers... fast... accurately... and locally! For your copy send \$20.00 (USA and Canada only; elsewhere send \$30.00) to address shown below.

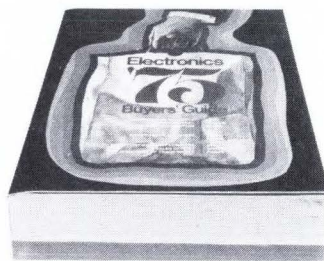

Electronics Buyers' Guide

A McGraw-Hill Publication
 1221 Ave. of the Americas, New York, N.Y. 10020

New products

and temperature-tracking of external resistors to maintain their high CMRRs. The AD521 J and K units are specified for operation from 0°C to 70°C. A military version, the AD521S, is specified from -55°C to 125°C. It has the same drift characteristics as the K version and sells for \$30 in singles, \$20 in 100s. All versions, packaged in hermetic 14-pin DIPs, are available from stock.

Analog Devices Inc., P. O. Box 280, Rte 1 Industrial Park, Norwood, Mass. 02062 [413]

MOS RAMs are organized as 256 words of 4 bits each

In an extension of its 2102 series of static n-channel silicon-gate MOS random-access memories, Intel has introduced a total of 21 new types, several of which are organized as 256 words of 4 bits each. This configuration reduces package counts for memory systems of 256 or 512 words; for example, a memory con-

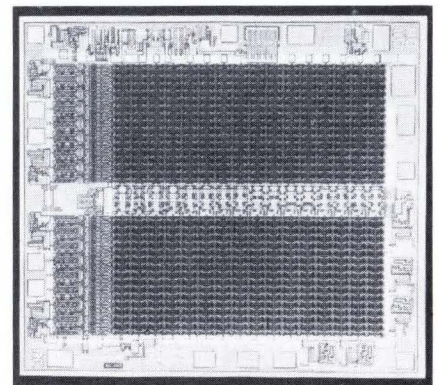

sisting of 256 16-bit words would require 16 RAMs of the 1-by-1,024-bit variety, but only four of the new ones. The 256-by-4-bit RAMs are offered in three different formats: the 2101 is a 22-pin device with separate input and output data lines, an output-disable function, and two chip-enable inputs; in lots of 100 pieces, it sells for \$9.40 in its 1-microsecond version, \$10.75 in its 650-nanosecond version, and \$12.75 in its 500-ns version. The 2111 has 18 pins, four common input/output lines, an output disable, and two

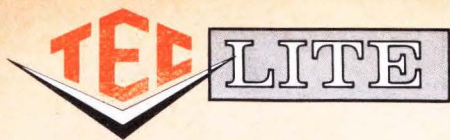

LOW-COST LED DIGITAL READOUTS IN RED, ORANGE, YELLOW OR GREEN

Solid State Modules Come Ready to Install and Operate – Include Decoder/Driver and all Circuitry Needed to Hook up to Your System

- Standard 0-9 plus overflow, with character heights of 0.30" and 0.40" – and both sizes at the same low price!
- Accept BCD input code
- Compatible with TTL
- Optional bezel with choice of 5 filters

And Immediate Delivery!

DISTRIBUTORS

Audio Electronics, Inc., Canada	(416) 495-0720
Bodelle Co., Inc., Chicago	(312) 323-9670
Bordewick Co., New England	(617) 659-4915
Century Aero Corp., So. California	(213) 772-1166
Peerless Radio Corp., Florida	(305) 566-5966
Ratel Electronics, No. California	(415) 965-2010



Only
\$7.95 Per Digit
in 100 quantities

0.30" High: MDA-6151 (green), MDA-6171 (red),
MDA-6181 (yellow), MDA-6191 (orange)
0.40" High: MDA-7151 (green), MDA-7171 (red),
MDA-7181 (yellow), MDA-7191 (orange)

TEC, Incorporated • 9800 NORTH ORACLE ROAD • TUCSON, AZ USA 85704 • (602) 297-1111 • TWX 910-952-1377



Circle 115 on reader service card



DESIGNING SPECIAL INTERFACES

TELELEC'S NEW EU METERS
DISPLAY TRANSDUCER
AND TRANSMITTER
OUTPUTS DIRECTLY.



\$10950 *
(3½ DIGITS)



\$14325 *
(4½ DIGITS)
*100 QUANTITY



Custom span,
offset and
label included.

CALL TOLL FREE (800)235-5951
IN CALIF. CALL COLLECT (805)485-5445
OR WRITE

TEKELEC, INC. TA

2623 Saddle Ave., Oxnard, Calif. 93030

Circle 147 on reader service card

Fluke Model 8000A

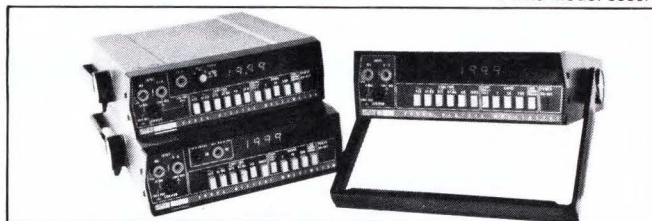

**No other DMM
offers you
all of these
outstanding
specs in
one box**

- Best accuracy statement of any 3½ digit DMM: 0.1% accuracy ± 1 digit; one year accuracy time span; 25° C $\pm 10^\circ$ C accuracy temperature span.
- Normal mode rejection: 60 dB at 50 and 60 Hz.
- Common mode rejection: 120 dB with 1 K Ω unbalance.
- Overload protection specified for all ranges.
- 26 ranges of volts, amps and ohms.
- More option power than any other DMM. Includes low ohms option with 1 milliohm resolution. 20 amp ac/dc current capability. BCD output. Built-in rechargeable battery pack.
- More accessories than any other DMM. Includes 600 amp AC clamp-on current probe. 40 KV high voltage probe. 100 and 500 MHz rf probes.
- Auto zero (no zeroing necessary).

Add to this the incomparable Fluke reputation. No wonder this is the best selling DMM in the world. Still only \$299 (domestic only). For data out today, dial our toll-free hotline, 800-426-0361.



John Fluke Mfg. Co., Inc.
P. O. Box 7428
Seattle, WA 98133

For information circle 148 on reader service card.
For demonstration circle 179 on reader service card.

NEW NEW NEW

STRIP CHART ADAPTER FOR X-Y RECORDER

Model 2000
Recorder
\$890
plus modules

Model SCA-1
Strip Chart
Adapter
\$765

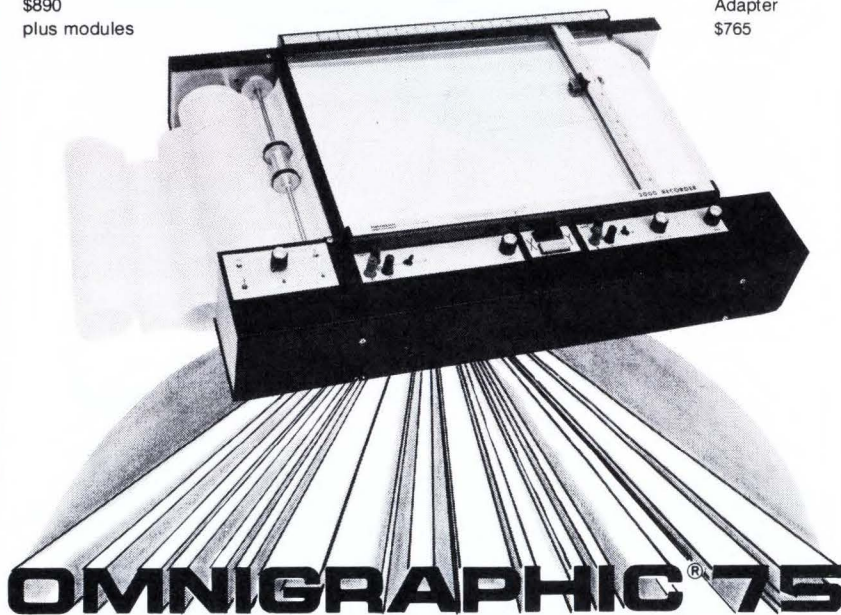

OMNIGRAPHIC® 75

PRESENTS NEW VERSATILITY
FOR YOUR 2000 X-Y RECORDER

- Converts any Omnigraphic 2000 X-Y into a Strip Chart Recorder.
- Provides single sheet advance (local or remote control) thus eliminating manual single sheet changing.
- Bi-directional chart drive
- Easily installed in the field
- Adapter only \$765 complete

Send for brochure today.

**houston
instrument**

**THE
RECORDER
COMPANY**

ONE HOUSTON SQUARE (at 8500 Cameron Road) AUSTIN, TEXAS 78753
(512) 837-2820 TWX 910 - 874-2022 cable HOINCO

EUROPEAN OFFICE Rochesterlaan 6 8240 Gistel Belgium
Phone 059/27445 Telex Bausch 19399

® A registered trademark of Houston Instrument

New products

chip-enable inputs. Its respective prices are \$8.60, \$9.90, and \$10.70. Finally, the 2112 is a 16-pin unit with four common I/O lines and one chip-enable input. Its corresponding prices are \$8.60 and \$9.90; no 500-ns model is offered.

Intel Corp., 3065 Bowers Ave., Santa Clara, Calif. 95051 [416]

C-MOS analog multiplexers
have low 'on' resistances

A pair of complementary-MOS analog multiplexers—the 16-channel IH5060 and the eight-channel differential IH5070—is manufactured by means of a floating-body process that stops latch-up when the power supply is interrupted. This eliminates the need for resistors in series with each channel and lowers the devices' effective "on" resistance to a maximum of 400 ohms for the wide-temperature-range military model and 450 ohms for the commercial one. Prices, in quantities of more than 100, are \$28 for the commercial units, which pull as much as 2 mA, and \$55 for the military models, which draws less than 300 μ A.

Intersil Inc., 10900 North Tantau Ave., Cupertino, Calif. 95014 [414]

IC analog multiplier has
maximum error of 0.25%

A laser-trimmed four-quadrant analog multiplier has a maximum error of 0.25% for all input combinations. The unit, which has a small-signal 3-dB bandwidth of 250 kilohertz, maintains its performance from 0°C to 70°C. External trimming can reduce the maximum error of the model 4204K to 0.1% if necessary. The multiplier sells for \$69 in unit quantities and \$52 in 100s. The 4204J, a similar unit with a maximum error of 0.5%, has a small-quantity price of \$49 and a 100-unit price of \$37. Delivery time is from stock to two weeks.

Burr-Brown, International Airport Industrial Park, Tucson, Ariz. 85734 [415]

Data handling

Graphics display is flexible

Microprocessor-controlled system for Nova generates EIA-compatible video signal

Lexidata Corp., a new company in Lexington, Mass., is moving into the market for lower-priced displays, the demand for which grows as minicomputers become less expensive. Lexidata's entry is a graphics

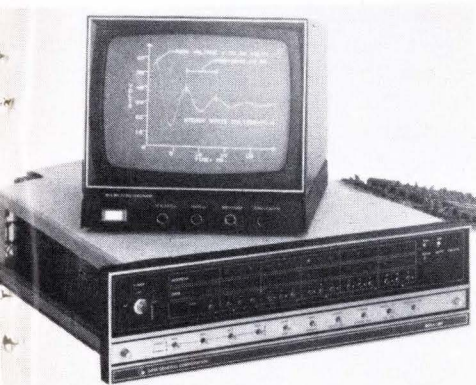

display system called the model 200, a 15-by-15-inch printed circuit card that plugs into Data General Corp.'s Nova minicomputer. It generates a mixed alphanumeric-graphic display and is priced at \$2,595 for one unit.

The 200's output is a composite video signal that is EIA-compatible, allowing it to use standard video monitors as CRT-display devices. This allows flexibility in screen size; for large displays it can even go to a video projector with a 4-by-6-foot screen. The output can easily be distributed via coaxial cable to more than one monitor and to monitors in remote locations. It can also be synchronized to any other video signal. A TV signal can therefore be mixed with the output from the 200, something that can't be done with a conventional graphics display.

There are four functional blocks in the 200—a microprocessor con-

troller, a central-processing-unit (CPU) interface, an output register, and synchronization circuitry. Communications between the first three blocks is through a common 16-bit memory bus. The controller is a discrete 8-bit TTL ROM-programable microprocessor designed by Lexidata. It has 20 microencoded instructions.

The controller communicates with the CPU via the CPU interface, either by interrupt I/O or through the direct memory access (DMA) channel. The output register is a shift type that is loaded from the memory bus. A word from the bus is converted to a video signal in the register and is combined with the video synchronization information to become the video output.

The minicomputer's main memory will provide a 256-by-240-dot display with a DMA-channel rate of less than 250 kilohertz. Refresh rate is 60 hertz. Lexidata can also interface a semiconductor refresh memory to the memory bus to make refresh independent of the CPU.

The microprocessor can be programmed to perform operations such as character and vector generation. Simply by changing the microinstructions, special alphabet-character sets such as those of foreign languages can be displayed, and the characters can be of any size. Characters can be displayed alone or mixed with graphics. Each dot is individually addressable, so characters can be plotted in any X-Y direction; they are not limited to vertical or horizontal lines.

The microprocessor also allows complete reformatting by changing its microinstructions. The screen can be partitioned into blocks of alphanumeric and graphics. Separate areas of the display can have different resolution characteristics. Normally the display has 24 lines of 42 characters each, but an optional high-density alphanumeric display forms concentrated bands of dots from which 18 lines of 80 characters each can be made. Delivery time is from stock to 30 days.

Lexidata Corp., 803 Massachusetts Ave., Lexington, Mass. 02173 [361]

Punched-tape reader pulls only 10 watts

A single power supply of 5 volts at 2 amperes is all that is needed to run the motor, lamp, and logic of a punched-tape reader from Teleterminal Corp. The bidirectional reader, called the Fly Reader 30, has a speed of up to 300 characters per second and is priced at \$365.

Use of a single power source is possible because the motor (specially adapted for high speed), the lamp, and the logic require only 5 volts. In most readers of this type, lamp and logic operate off 5 v, but voltage requirements for the motor are much higher, necessitating a second voltage source.

The tape drive is an integral-sprocket stepper-motor assembly, which dissipates only 7 watts, so it runs cool, prolonging the life of the windings. Control logic is provided, along with the motor-sequencing logic and drivers, to prevent reading errors associated with motor overshoot and resonance. The machine uses an on-the-fly reading technique that results in accurate reading at varying speeds. Unlike most tape readers, which scan character-to-character and break at the character, the Teleterminal model scans whole characters and stops between two, increasing both reliability and speed.

The reader will accept randomly spaced pulse-input commands for character-at-a-time reading or an input-command level for continuous reading. Its interface uses transistor-transistor logic with a simple control scheme easily adaptable to a major-

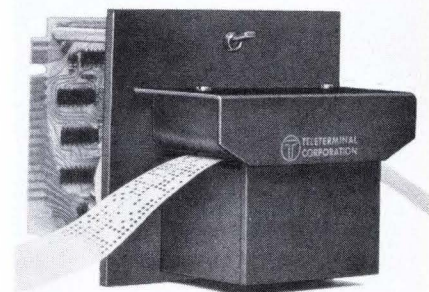

New products

ity of host systems. The reader is especially suitable for applications in automatic testing, data communications, graphic arts, and numerical control. The unit will read any eight-level, 1-inch punched tape. As an option, it will interchangeably read both 1-inch eight-track and six-track advanced-feed-hole type-setting tapes. Any tape with a transmissivity of less than 60% can be read without adjustments.

The light source of the unit is a line-filament lamp, which is operated at a low voltage to give it more than 15,000 hours of life. The detector array consists of nine phototransistors that are prematched at the array, eliminating the need for separate channel adjustments or resistor selection when the array is replaced. The outputs from the phototransistors are conditioned to TTL levels by Schmitt triggers to provide two-thirds full-scale noise immunity.

The price of the Fly Reader 30 in quantities of one to nine is \$365. Delivery is from stock to 60 days.

Teleterminal Corp., 12 Cambridge St., Burlington, Mass., 01803 [362]

CRT terminal is highly flexible

The TD 820 input and display system is a cathode-ray-tube unit that can be equipped with cassette tape stations, mini-disks, line printers, and a choice of three keyboards. Among its built-in capabilities are a "blank-video" mode in which an operator can key in a piece of data, such as a security code, without hav-

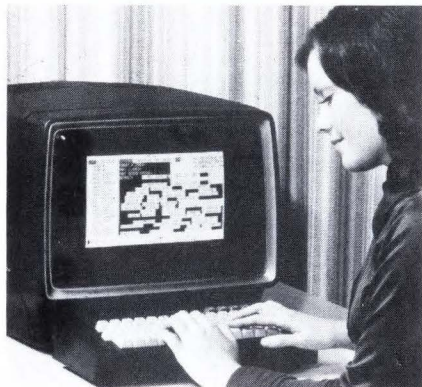

ing it displayed, and a blinking feature which can call a character or field of characters to the operator's attention. Prices of the TD 820 will vary with options, but the manufacturer cites \$6,250 as the price of a typical 960-character unit, and \$6,800 as the price of a typical 1,920-character terminal. The machines can also be leased.

Burrhoughs Corp., Business Machines Group, Detroit, Mich. 48232 [364]

Small-computer disk units store 40 or 80 megabytes

A pair of disk drive units—one with 40 megabytes of storage, the other with 80—is intended to meet the growing memory demands of small and medium-size computer systems less expensively than multi-unit disk systems. The 40-megabyte DM-940 sells for approximately \$5,000 in OEM quantities and will be available in volume in the second quarter of the year. The DM-980 will be ready for delivery during the third quarter and will be priced at about \$6,500. Each model will be offered in both 19-inch rack-mounting or free-standing versions.

Ampex Corp., 401 Broadway, Redwood City, Calif. 94063 [363]

Rugged microprocessor for industrial control

A ruggedized 8080 microprocessor system, intended for industrial control and for use in severe environments generally, incorporates field-reprogrammable read-only memories and compatible random-access memories. The unit is completely compatible with Intel's 8080 processor components and software, which thus may be used for prototype development. The system has a 2-microsecond cycle time (1.2 μ s is optional), 74 processor instructions, unlimited subroutine nesting, and multilevel priority interrupts.

Applied Systems Corp., 26401 Harper, St. Clair Shores, Mich. 48081 [365]

MF8080

AVAILABLE FROM
U.S.A.

microsystems sales offices

CA., Palo Alto, (415)493-0848
CA., Santa Ana, (714)979-6522
IL., Schaumburg, (312)894-7660
PA., Huntingdon Valley, (215)947-5641/2
MA., Waltham (617)890-2255
NJ., Morris Plains (201)539-8050

sales representatives

AL., Huntsville, Rep Inc. (205)881-9270
AZ., Scottsdale, Barnhill Five (602)947-5745
CA., Los Alamitos, J.S. Heaton (213)598-6676
CA., Los Altos, W.W. Posey (415)948-7771
CA., San Diego, J.S. Heaton (714)452-1456
CO., Littleton, Simpson (303)794-8381
FL., Orlando, G.F. Bohman (305)855-0274
IL., Chicago, L-Tec (312)286-1500
IN., Fort Wayne, Waid & Assoc. (219)422-4344
MD., Towson, L.H. Kolman (301)752-8756
MA., Waltham, Rantek (617)890-5110
MI., Milford, Tom Mulligan (313)363-5575
MN., Minneapolis, Comstrand (612)560-5300
NJ., Tenafly, ABC (201)568-2354
NY., Cicero, Adv. Comp. (315)699-2651
NY., Tarrytown, ABC (914)631-2650
NY., Williston Park, ABC (516)747-6610
OH., Cincinnati, Ron Makin (513)232-5588
OR., Beaverton, Arneson (503)643-5754
PA., Huntingdon Valley, ABC (215)947-5641
TX., Dallas, J. Clay (214)350-1281
UT., Salt Lake City, Simpson (801)486-3731
WA., Seattle, Arneson (206)762-7664

stocking distributors

AZ., Phoenix, Moltronics (602)272-7951
AZ., Phoenix, Sterling (602)258-4531
CA., Riverside, Electronic Supply (714)683-7300
CA., San Diego, Moltronics (714)278-5020
CA., San Diego, Sterling (714)565-2441
CA., San Carlos, Sterling (415)592-2353
CA., Southgate, Moltronics (714)521-7412
CA., Sunnyvale, Bell Industries (408)734-8570
CA., Sun Valley, Sterling (213)767-5030
CT., Westport, Hi-Rel (203)226-4731
FL., Clearwater, Diplomat (813)443-4514
IL., Elk Grove Village, Diplomat (312)595-1000
IL., Elmhurst, Semispecs (312)279-1000
IL., Skokie, Bell Industries (312)965-7500
IN., Indianapolis, Semispecs (317)243-8271
MD., Baltimore, Arrow (301)247-5200
MD., Gaithersburg, Pioneer (301)948-0710
MA., Boston, Demambro (617)787-1200
MA., Dedham, Gerber (617)329-2400
MA., Watertown, Sterling (617)926-9720
MI., Farmington, Diplomat (313)477-3200
MI., Farmington, Semispecs (313)478-2700
MN., Bloomington, Arrow (612)888-5522
MN., Minneapolis, Diplomat (612)788-8601
MN., Minneapolis, Semispecs (612)854-8841
MO., Hazelwood, Semispecs (314)731-2400
MO., Kansas City, Semispecs (816)452-3900
MO., St. Louis, Diplomat (314)634-8550
NJ., Haddonfield, Mid-Atlantic (609)428-8288
NJ., Kenilworth, Newark (201)272-8410
NJ., Saddlebrook, Arrow (201)797-5800
NM., Albuquerque, Sterling (505)345-6602
NY., Farmingdale, Arrow (516)694-6800
NY., Freeport, Milgray (516)546-6000
NY., New York, C. Tennant (212)679-1300
NY., Rochester, Simcona (716)328-3230
NY., Woodbury, C. Tennant (516)364-9070
OH., Dayton, Diplomat (513)228-1080
OH., Dayton, Semispecs (513)278-9455
OH., Solon, Repco (216)248-8900
PA., Horsham, Pioneer (215)674-5710
PA., Pittsburgh, Semispecs (412)781-8120
TX., Dallas, K A Electronic Sales (214)634-7870
TX., Dallas, Semispecs (214)358-5211
TX., Dallas, Sterling (214)357-9131
TX., Houston, Sterling (713)623-6600
UT., Salt Lake City, Diplomat (801)486-7227
WA., Seattle, Sterling (206)762-9102
WI., Wauwatosa, Semispecs (414)257-1330

CANADA

microsystems sales offices

QUE., Montreal, (514)747-5551
ONT., Ottawa, (613)828-9191
ONT., Toronto, (416)741-3667

stocking distributors

BC., Vancouver, R.A.E. (604)687-2621
ONT., Malton, Semispecs (416)678-1444
ONT., Rexdale, Future (416)677-7820
ONT., Toronto, Zentrionics (416)789-5811
QUE., Montreal, Future (514)735-5775

**MICRO
SYSTEMS** 
a Northern Electric company

MF8080

... now

Got the sole source blues?

Forget 'em, your second first source is here.

Microsystems' MF8080 is identical to Intel's 8080 and its available now.

Spec-wise, process-wise, performance-wise there is no difference. Price-wise - give us a call and we'll talk about it.

And MF8080 is backed-up by Microsystems' complete portfolio of RAM, ROM, pROM and interface circuits.

For more information about MF8080 contact any of Microsystems' outlets listed on the facing page. Microsystems International Limited, Box 3529, Station C, Ottawa, Canada K1Y 4J1

**MICRO
SYSTEMS** 
a Northern Electric company

The counter specialists have done it again!



New S-D family makes buying decisions easy. 5 MHz to 512 MHz.

Whether you need a simple frequency counter, a complete universal counter-timer, or a quality communications counter, Systron-Donner has it... at a sensible price and with features nobody else has.

1. Low cost frequency counter. Model 6202A is a simple, straightforward and reliable workhorse for frequency counting to 5 MHz. Especially suited for industry and education. Price only \$435.

2. Complete universal counter-timer. S-D's 50 MHz Model 6250A offers all universal functions along with such standard features as trigger levels, pre-set positions, 2 independent inputs, automatic and manual resolution, and 8 digits. Price \$740.

3, 4, 5. great communications trio. S-D gives you a choice of three frequency counters, all with 8 digits, tone measurement and sensitivity control to reject noisy signals. Options include 5 oscillators to $5 \times 10^{-10}/24$ hr. and an internal battery pack. Model 6220A is a 50 MHz unit upgradable to 180 MHz or 512 MHz. Price \$650. Model 6251 covers to 180 MHz. Price \$985. Model 6252 (shown) measures to 512 MHz. Price \$1195. Relay overload protection and metered input are standard on the 6251 and 6252.

For immediate details contact your Scientific Devices office or Systron-Donner at 1 Systron Drive, Concord, CA 94518. Phone (415) 676-5000.

SYSTRON  DONNER

Circle 120 on reader service card

There are 170 different ohmic values between 0.51 E and 5.6ME you might need!

Don't worry,
our resistor-set RS 10
has 'em all

An electronic-designer should never be stopped by a missing carbon-film-resistor. With our new resistor-set RS 10 you don't have to care anymore about any ohmic value, because it contains 2.725 pieces R-ohm carbon-film-resistors 1/4 watt, type R 25 J, altogether 170 different values from 0.51 E up to 5.6 ME (E 24-series).

Do you know how many of each ohmic-value one needs? We do. Not by experience only. An ABC-Analysis gave us exact figures and we built up our set accordingly. That is why the quantity of each value varies and why our set contains enough of even those values which are most frequently used.

Type RS 11 and RS 12

These small-sized resistor-sets contain only 40 different ohmic-values but these are the most important ones: the complete E 6-series from 1 E up to 3.3 ME.

**For detailed Information please write to:
If you are interested in becoming a distributor for our new resistor-sets please contact us.**

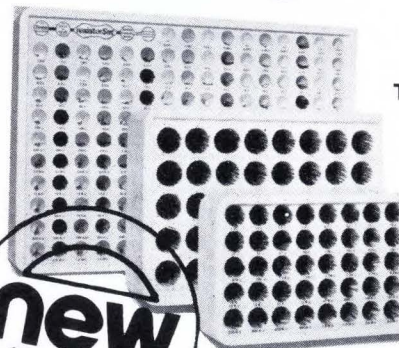

Type RS 10

Type RS 12

Type RS 11

RS 11: 4.000 pieces R-ohm carbon-film-resistors 1/4 or 1/3 watt (you have the choice), type R 25 J or R 33 J.

RS 12: contains the same number of 1/2 watt resistors type R 50 J.

This is our new product-line for Developing Laboratories, Service Departments, Schools of Technology and Engineering, Small Series Manufacturers Electronic and Shortwave Amateurs.



dinges elektronik gmbh

Mühlenstraße 71

Telefon 0 21 61/2 98 97

D 4051 Korschenbroich

West Germany

120 Circle 149 on reader service card

Electronics/March 6, 1975

Components

Gas-type readout is 1 inch high

Seven-segment planar numeric can be read from 60 feet away

Games and automotive-test equipment are among the uses in which a 1-inch-high numeric display from Beckman Instruments will likely shine. The unit, model SP-101, joins a line that includes $\frac{1}{3}$ - and $\frac{1}{2}$ -in. high seven-segment planar gas-discharge readouts.

The new display can serve a practical or an esthetic purpose, according to Robert Kuntz, product marketing manager for Beckman's Information Display operation. It's visible at 60 feet, and it's large enough to look good on a bulky piece of equipment. Viewing angle is 150° .

Each module in the new readout is a single digit; the package is the same as that used for the triple $\frac{1}{3}$ -inch display, being 1.125 in. wide by 0.83 in. high by 0.226 in. deep. Because of the size of the segments, each is supported by two mounting pins. The unit also includes colon, comma, and decimal point.

The displays are a bright orange, filterable to red. Brightness is 100 to 500 foot-lamberts, depending on current. The display can be read under all conditions, including direct sunlight.

The SP-101 has operating characteristics similar to those of the smaller Beckman displays and can be driven by the Beckman IC drivers, DD-700 and DD-702, as well as those supplied by several semiconductor manufacturers. Power requirement is 160 volts dc at 700 microamperes per segment—about twice the current of the $\frac{1}{2}$ -in. display. A keep-alive cathode provides an internal ion source that reduces reionization time to less than 30 microseconds, allows zero suppression,

and improves the display's operation in cold and darkness. The standard unit is \$5.75 per digit in 1,000-unit lots or \$9.50 each for 100 units. Special characters are available for custom applications.

Beckman has also started production of field-effect liquid-crystal displays for watches. The units offer low power consumption and high readability in ambient light.

Beckman Instruments Inc., Information Display Operation, P.O. Box 3579, Scottsdale, Ariz. 85257 [341]

Elapsed-time meters operate from regulated 5-V supplies

Both power and money can be saved if an elapsed-time meter can be run from the regulated 5-volt supply available in most electronic equipment, instead of from 28-v dc and 115-v ac lines. The MS 90386 is such a meter. Consuming less than 25 microwatts of power, it's an

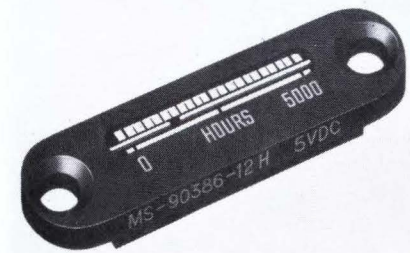

analog indicator with a depth less than 0.2 inch, a panel-area requirement of less than 0.5 square inch, and a weight of 0.07 ounce. Offered with 1,000-hour and 5,000-hour time scales, the military-grade units sell for less than \$10 each in moderate quantities.

Curtis Instruments Inc., 200 Kisco Ave., Mount Kisco, N.Y. 10549 [343]

5-A solid-state relay can be driven by MOS logic

Capable of switching from 50 milliamperes to 5 amperes ac, a solid-state relay can be triggered by the low power levels available from

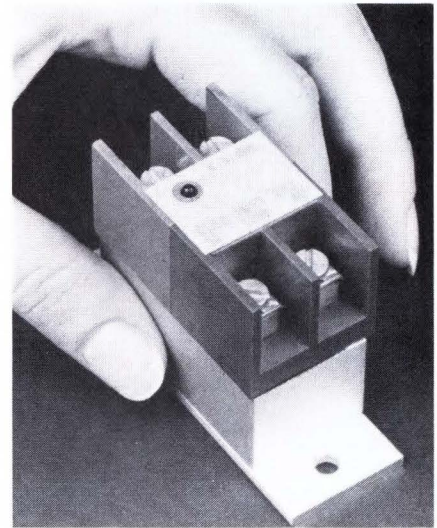

MOS circuitry or even a photocell. The relay can handle full-cycle surges as high as 60 A and works with ac voltages from 6 to 140 V rms. Its zero-voltage turn-on characteristic eliminates radio-frequency interference. No external heat-sinking is needed, and a built-in lamp glows when the relay is energized.

Electronic Instrument & Specialty Corp., 42 Pleasant St., Stoneham, Mass. 02180 [344]

Single-turn cermet trimmer is priced below 50 cents

Available in a range of resistance values from 10 ohms to 2 megohms, the type E single-turn cermet trimming potentiometer sells for less than 50 cents each in large quantities. The immersion-sealed unit is

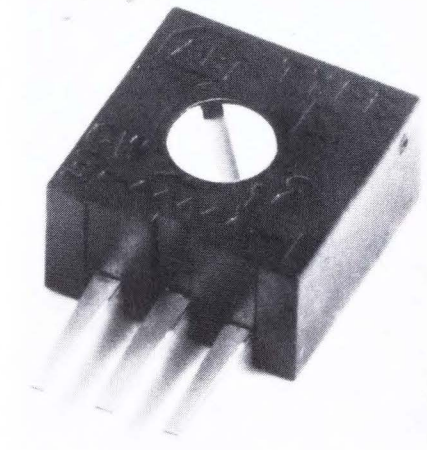

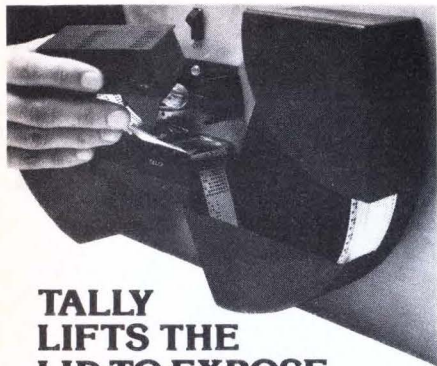

**TALLY
LIFTS THE
LID TO EXPOSE
A BETTER READ
HEAD DESIGN.**

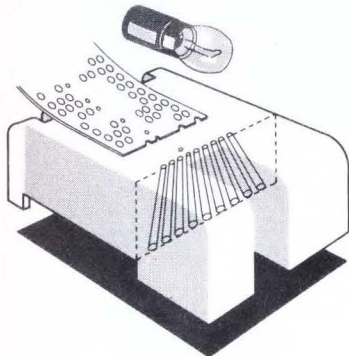

The complex read head is dead. To make our point, the Tally R-2000 keeps reading reliably with the read head cover removed.

The above illustration tells Tally's story of simplicity. The key is the angular deep socket photo transistor array. A single lamp source is placed above the reading area with the deep sockets below the tape character angled toward the light filament.

This eliminates lenses, fiber optics, potentiometers, matching resistors, or anything else that requires critical adjustments. The 100,000 hour lamp is inexpensive and readily available — you can get one in any hardware store.

The advantages go on. Ambient light on the read head doesn't affect reading reliability. You can see the last character read. Tapes with transmissivity up to 60% are accurately read.

The R-2000 offers fully proportional reeling. A four phase stepping motor delivers more torque, gives faster response, and minimizes tape oscillation.

For complete technical and quantity discount information, we invite your inquiry.

Tally Corporation, 8301 S. 180th St., Kent, Washington 98031. Phone (206) 251-6771.

TALLY®

New products

leak-tested in water at 85°C and has an operating temperature range of -55 to +125°C. Power rating is 0.5 watt at 70°C. Tolerance on device resistance is ±10%, and temperature coefficient of resistance is 100 ppm/°C for all values over the entire temperature range. The device is housed in the popular 3/8-inch-square package and is made in six different configurations.

Allen-Bradley Co., Electronics Div., 1201 South Second St., Milwaukee, Wis. 53204 [345]

Power inductors carry up to 2.75 amperes

Intended principally for use in switching regulators and output filters, a line of power inductors has current ratings as high as 2.75 amperes. Able to operate over the tem-

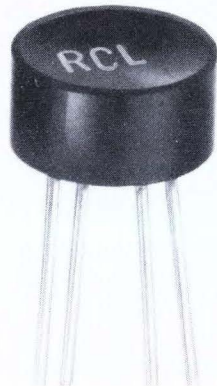

perature range from -55°C to +70°C and claimed to be extremely stable with regard to temperature changes, the inductors are made with values from 0.5 to 2.0 millihenries.

RCL Electronics Division, AMF Inc., 700 South 21 St., Irvington, N. J. 07111 [347]

Four-pole, double-throw relay switches 10 amperes

A four-pole, double-throw industrial relay can handle 10-ampere loads with each of its four contact pairs, provided that the total current

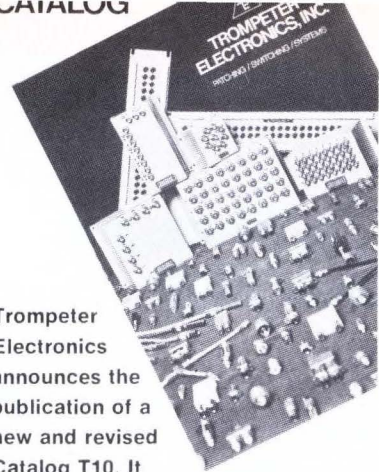

Trompeter Electronics announces the publication of a new and revised Catalog T10. It

contains a technical paper 'Noise in Cable Systems'. The section on patching includes panels, jacks, connectors, patch cords and networks. A third section describes 50 and 75 ohm matrices, switches and systems in coax, twinax and triax from DC to 3 GHz.

TROMPETER ELECTRONICS, INC.
8936 Comanche Ave.
Chatsworth, CA 91311
Tel. 213/882-1020

Circle 150 on reader service card

High-Accuracy

**Phase
Meters**

0.5 Hz to 2 MHz

**Digital or meter
readouts**

As low as \$1050



930 E. Meadow Dr. Palo Alto, Ca. 94303
(415) 321-7428

Circle 151 on reader service card

New products

through the relay does not exceed 30 A. The unit is thus well suited for applications in which, say, a three-phase line must be switched while a fourth contact is needed to activate a signal lamp or other auxiliary load. Gold-diffused silver-cadmium-oxide contacts and good wiping action make for high reliability. The Frame 284 relay is protected by a clear polycarbonate cover and sells for \$6.75 each in quantities of 100 pieces.

Struthers-Dunn Inc., Lambs Rd., Pitman, N. J. 08071 [346]

Diffused-lens LED lamp is current-regulated

A gallium-arsenide-phosphide plastic-encapsulated light-emitting diode developed by National Semiconductor Corp. also contains a current-regulating integrated circuit that provides constant intensity over a wide voltage range.

The LED lamp, designated the NSL4944, has a very-low turn-on voltage—2 to 2.4 volts—and gives a constant red-light output of 0.8 millicandela up to 18 v. It also works on ac up to 18 v peak to peak, as well as having a reverse voltage of 18 v. The lamp can be driven directly from transistor-transistor logic without resistors and has a power-dissipation rating of 300 milliwatts.

James Bryson, product marketing manager for optoelectronics at National Semiconductor, says that applications identified so far for the versatile LED include indicator lamps for back-lighted panels, optical couplers, annunciators, ac indicator lamps, battery-charge indicators, relay-closure indicators, and toy-train lights, where varying track voltages are hard on incandescent bulbs.

National Semiconductor Corp., 2900 Semiconductor Dr., Santa Clara, Calif. [348]

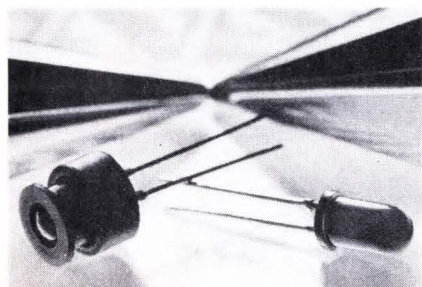

Happy birthday, price-less.

Introduced just one year ago, our 102A FM/AM Signal Generator is celebrating a well-earned sales success against the HP8640B that once had the market sewn up. It's no wonder when you can save thousands of dollars and still get all you really need.

With our generator you get a well shielded, low noise source from 4.3 to 520 MHz that is both stable in frequency and accurate in level. We've shrunk warmup to 15 minutes and weight to 30 lbs.

We have the best residual FM spec around: 100 Hz resolution with a 6-digit display, individual metering of modulation and RF output, true peak monitoring, and 0-300 kHz internal FM deviation on all bands—external FM deviation can be as wide as 2 MHz peak-to-peak even at the lowest frequencies.

The 102A is engineered for your convenience. That's why we've designed a front panel that is easy-to-use and understandable, why we have the specifications decaled on the top of the instrument in plain view, why we've added a unique adjustable "feel" main drive mechanism for easy narrow-band receiver setting, and why we have a full list of optional goodies—like a detected AM output to verify our negligible phase-shift for VHF omnitesting, fused RF output with replaceable elements, and external clock input.

Call or write today for data and/or a demo and you'll call the 102A price-less, too. Boonton Electronics Corp., Rt. 287 at Smith Rd., Parsippany, N. J. 07054; (201) 887-5110.

Price \$3575.

BOONTON

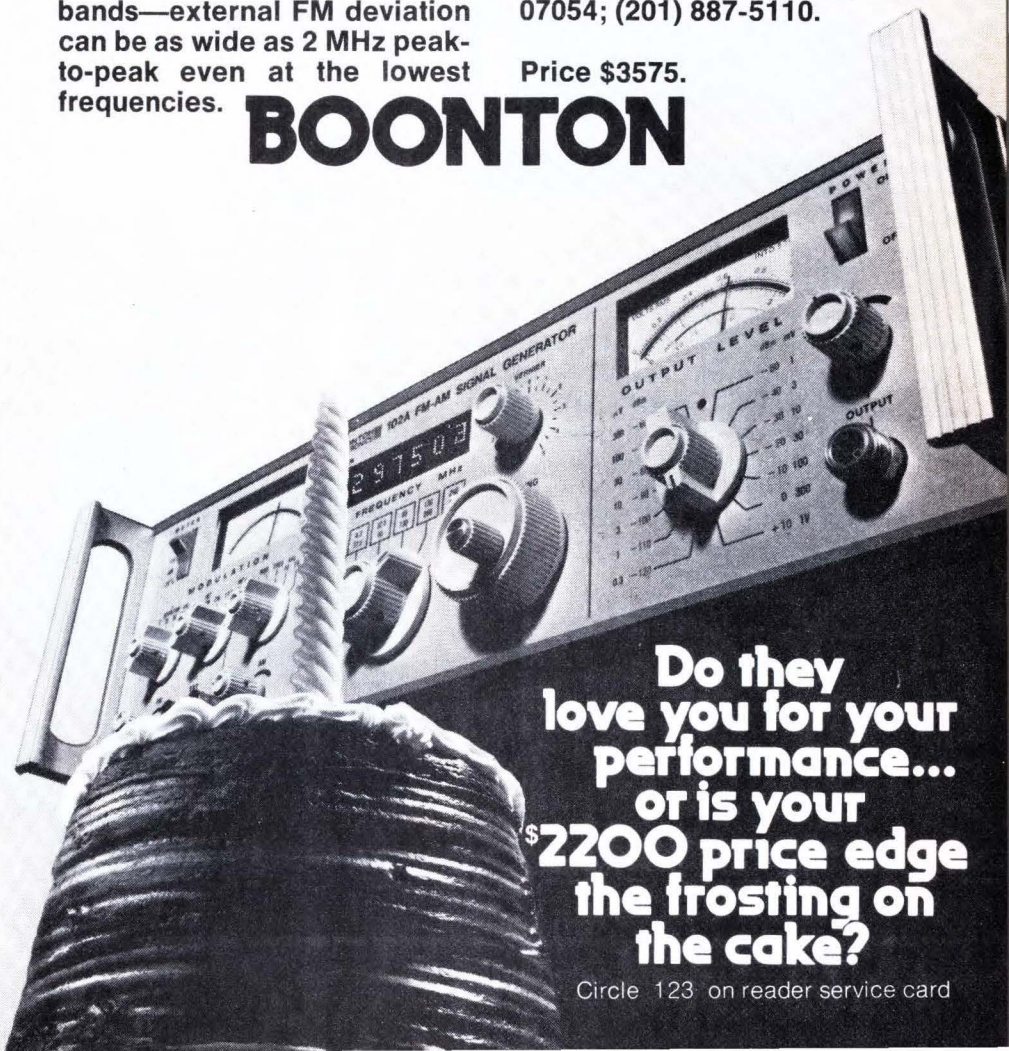

Do they
love you for your
performance...
or is your
\$2200 price edge
the frosting on
the cake?

Circle 123 on reader service card

Instruments

Counter tests land-mobile sets

Low-priced unit covers 417 to 512 MHz; operates from power line or battery

As use of the land-mobile radio band from 470 to 512 megahertz grows, the need for test equipment in this band also increases. The model 5755A six-digit portable frequency counter offers direct count-

shunted by approximately 25 picofarads, covers the range from 10 Hz to 100 MHz with a sensitivity of 35 mv rms up to 40 MHz and 50 mv rms at 100 MHz. A 50-ohm input handles frequencies from 10 MHz to 512 MHz with a sensitivity of 25 mv rms up to 400 MHz and 35 mv rms to 512 MHz.

The instrument can also determine frequency ratios if the higher of two frequencies is applied to the front-panel input and the lower frequency controls the gate time through a rear-panel connector. The rear-panel port accepts transistor-transistor-logic levels at frequencies from dc to 5 MHz.

The display's six digits are formed by light-emitting-diode dot matrixes measuring 0.375 inch high. The counter's internal crystal-controlled oscillator has an aging rate of less than 2 parts per million per month, and temperature-induced drift is less than 5 parts in $10^7/^\circ\text{C}$ from 0 to 40°C .

Ballantine Laboratories Inc., P.O. Box 97, Boonton, N.J. 07005 [351]

parts; even the test leads are connected by means of recessed banana plugs. Three fuses, including a special 2-ampere, 1-kilovolt unit, provide complete overload protection for all functions and ranges for voltages up to 1,000 v. The special fuse is needed because smaller fuses sometimes continue to conduct, either by arcing across the ends of the blown fuse wire or by ionizing the area surrounding the wire. The model 60 has 33 ac and dc voltage, ac output voltage, resistance, dc current, and decibel ranges. Accuracy is within 2% of full scale on dc, 3% on ac, and 2% of arc length on resistance. Price is \$90 including test leads, insulated alligator clips, batteries, and spare fuses. A mirrored-scale version—the 60-A—with a maximum dc error of 1.5% is priced at \$100.

Triplet Corp., Bluffton, Ohio 45817 [352]



ing to 512 MHz and beyond. In addition, its low weight, line or battery operation, input-overload protection, and \$745 price tag make it attractive for servicemen, technicians, and students, as well as engineers.

The instrument weighs five pounds and is housed in a high-impact plastic case. It can be operated from either an ac line or 11- to 18-volt dc power sources, including automobile batteries.

The high-impedance input of the model 5755A is protected even at power-line levels. It can withstand 250 v rms from 10 hertz to 1 kilohertz, and 10 v rms above 10 MHz. The 50-ohm input can withstand up to 3 v rms, and is fuse-protected at 2 v rms for normal operation.

The model 5755A measures frequencies from 10 Hz to 512 MHz through either of two input ports. Its high-impedance input, 1 megohm

Rugged VOM emphasizes safety

Several features in the model 60 volt-ohm-milliammeter are designed to prevent the user from accidentally hurting himself or the instrument. The completely insulated, rugged instrument has no exposed



Low-cost synthesizers have four-digit resolution

A pair of frequency synthesizers with maximum frequencies of 100 kilohertz and 1 megahertz have prices of \$725 and \$830, respectively. The 100-kHz model PM5141 and the 1-MHz model PM5142 use four thumbwheel switches to set their four significant digits, and a series of push buttons to choose their ranges. The sine/square wave instruments are remotely programmable for automatic testing applications. The sine-wave output amplitude is continuously variable up to 10 volts (peak to peak) into an open circuit, or 5 v into 600 ohms. Three push buttons provide up to 60 decibels of attenuation in 10-dB steps, giving the instrument a min-

Designing with Microprocessors:

A 2-hour home TV special April 15-18...

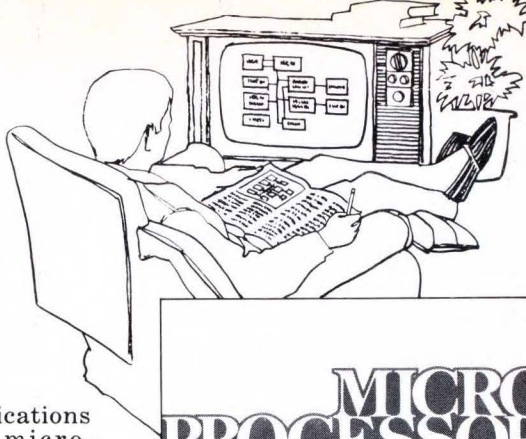

This is your chance to get authoritative answers to questions about today's hottest design topic: microprocessors. Read TI's Microprocessor Handbook. Then watch our 2-hour TV lecture series right in your own home. You'll learn what the microprocessor revolution is all about and how it can affect your designs. Plus you'll get valuable reference information on the leading edge of the technology.

Two hours of microprocessor information... on your TV set.

Tune-in your television to two hours of microprocessor technical lectures presented by the Texas Instruments Learning Center, April 15-18. You'll see four half-hour sessions—one each morning, Tuesday through Friday—timed so they won't interfere with your regular work day:

TUESDAY April 15: System architecture

A discussion of digital computer system architecture as a basis for understanding microprocessors. Evolution of microprocessors... peripheral controllers... parallel processors... Direct Memory Access.

WEDNESDAY April 16: Microprocessor logic—what type?

Chip fabrication technologies are reviewed—including most MOS forms, TTL, Schottky TTL and the new Integrated Injection Logic (I²L) which has the density and power dissipation of MOS and the speed and driving capabilities of bipolar.

THURSDAY April 17: Potential applications for microprocessors.

Guidelines for using microprocessors, including both advantages and limitations for certain types of equipments. Shows how microprocessors can lower costs, shorten design cycles, improve performance and reliability in practical applications.

FRIDAY April 18: Using microprocessors in communications systems.

Discusses problems of digital communications and typical hardware

solutions. In-depth applications guidelines show how microprocessors can be used economically within this broad field.

Don't miss this opportunity to explore this dynamic new technology—with only two hours of early morning television. Check TI's broadcast schedule for your city:

CITY	CHANNEL	TIME
Boston	7	6:20 AM
Chicago	9	6:00 AM
Cleveland	8	6:00 AM
Dallas	5	6:00 AM
Dayton	7	6:00 AM
Denver	4	6:30 AM
Detroit	2	6:00 AM
Houston	11	6:30 AM
Los Angeles	11	6:30 AM
Miami	4	6:00 AM
Minneapolis	11	6:30 AM
New York City	5	6:30 AM
Orlando	6	6:00 AM
Philadelphia	To be announced*	
Phoenix	5	6:00 AM
Rochester	10	6:00 AM
San Diego	6	6:30 AM
San Jose	11	6:00 AM
Seattle	11	6:30 AM
Washington, D.C.	5	6:30 AM

*See our ad on the TV page of your April 14 newspaper.

MICROPROCESSOR HANDBOOK

...and this fact-filled book.

200 pages of up-to-date design information... for only \$24.95.

The Microprocessor Handbook is your source for up-to-date microprocessor information—fully objective, concentrated, use-oriented data that might take you months to assemble on your own:

ALU's • Controllers • Memories • Timing • Microprocessor Selection Guide • Microprocessor Comparison Chart • In-depth discussion of I²L technology • Digital Computer System Architecture • Chip Architecture • Chip Fabrication Technologies • How to Use a Microprocessor • Potential Applications and Limitations • Microprocessors in Communications • Microprocessor Supplier Listing • Glossary of Microprocessor Terms • Bibliography

Microprocessors have the potential to revolutionize electronic system design and replace many mechanical and electro-mechanical systems. That's why TI's information-packed Microprocessor Handbook is a must for your personal library. Review it before you watch TI's TV presentation. Use it to jot down notes during the lectures. Then keep it as a permanent reference. Order your copy now to allow ample time for delivery before TI's April 15-18 telecast.



Order your Handbook now... before the TV presentation.

To: Texas Instruments Incorporated

Please send me _____ copies of the Microprocessor Handbook (LCB1761). I enclose check, money order, company purchase order for _____ (\$24.95 for each book ordered*)

Mail checks and money orders to:
P. O. Box 3640, M/S 84, Dallas, Texas 75285

Mail company purchase orders to:
P. O. Box 5012, M/S 54, Dallas, Texas 75222

Name _____

Company _____

Street _____

City _____

State _____

ZIP Code _____

*Texas residents please add 5% sales tax.

TEXAS INSTRUMENTS

INCORPORATED

THE WIDEST SELECTION OF MIL-QUALIFIED POWER SUPPLIES

Specified into the most sophisticated systems requiring extreme environmental applications

- Shipboard
- Airborne
- Ground Support
- Communications

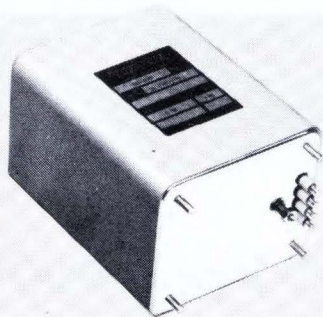

QUALIFIED FOR EXTREME MIL ENVIRONMENTS

TECHNIPOWER PM-95 and F/FD-115 AC-DC SERIES

**3 to 325 VDC, up to 800W
Base temperatures to 115°C**

Qualified for:

MIL-STD-810	MIL-STD-202
MIL-E-5400	MIL-E-4970
MIL-E-16400	MIL-E-5272
MIL-S-901	MIL-STD-461/462

Backed By 5-Year Warranty

SEND FOR FREE 66-PAGE DESIGN/DATA CATALOG

TECHNIPOWER, INC. 
A BENRUS SUBSIDIARY

Benrus Center
Ridgefield, CT 06877
(203) 431-1300

New products

imum unloaded output of 10mv.
Philips Test & Measuring Instruments Inc.,
400 Crossways Park Dr., Woodbury, N. Y.
11797 [355]

'Naked' oscilloscope
sells for \$350

The Telonic model 4060 is supplied as an uncased chassis for incorporation into educational, medical, automotive, and recreational products that need a cathode-ray-tube display. It is a three-axis module that includes an 11-inch CRT, a power supply, and a minimum of control circuitry. Although it contains no X-axis sweep or trigger circuitry, it does have a horizontal sensitivity of

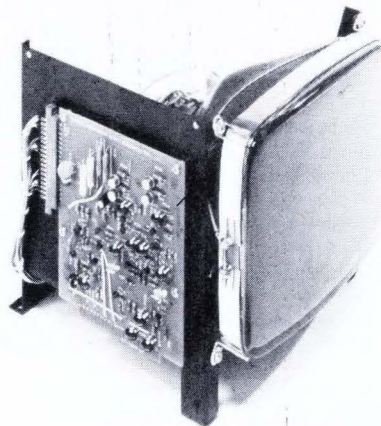

about 1.5 inches per volt and a bandwidth of 4 kilohertz. The vertical channel has a 15-kHz bandwidth and a sensitivity of about 1 in./v. The unit's intensity-modulation (Z-axis) input has both ac and dc inputs so it can handle pulse applications. Single-quantity price of the 4060 is \$350.

Telonic Altair, 21282 Laguna Canyon Rd.,
Box 277, Laguna Beach, Calif. 92652 [353]

Miniature recorder tracks
ac voltage and current

People who want to monitor line voltages and current drains can do both on a single miniature two-

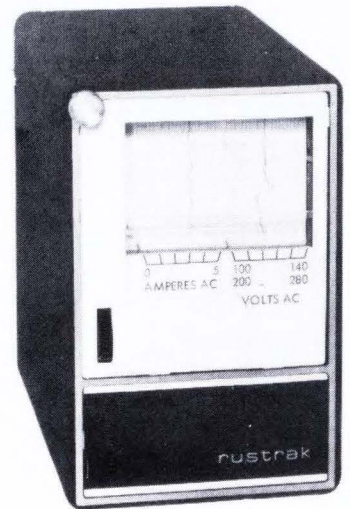

channel chart recorder—the Rustrak series 2120. This family of recorders measures ac currents on a single 0-to-5-ampere channel, and ac voltages on one of three voltage ranges: 100 to 140 volts, 200 to 280 v, or 400 to 560 v. One, two, or three voltage ranges can be supplied in one instrument. Each of the instrument's two channels is 1 inch wide; writing is by means of a stylus on pressure-sensitive paper. Interchangeable gears make a wide range of chart speeds possible.

Measurement & Control Systems Division,
Gulton Industries Inc., East Greenwich, R. I.
02818 [354]

100-MHz scope is portable,
has sensitivity of 5 mV/cm

Dumont's model 1100P is a dual-channel, delayed-sweep oscilloscope with a bandwidth of 100 MHz, a vertical sensitivity of 5 millivolts per centimeter, and a price of \$1,895,

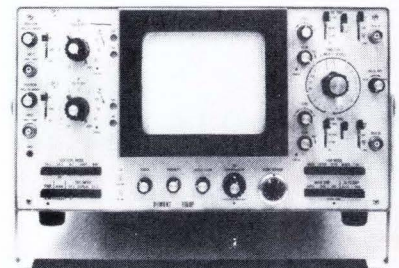

Energy Saver

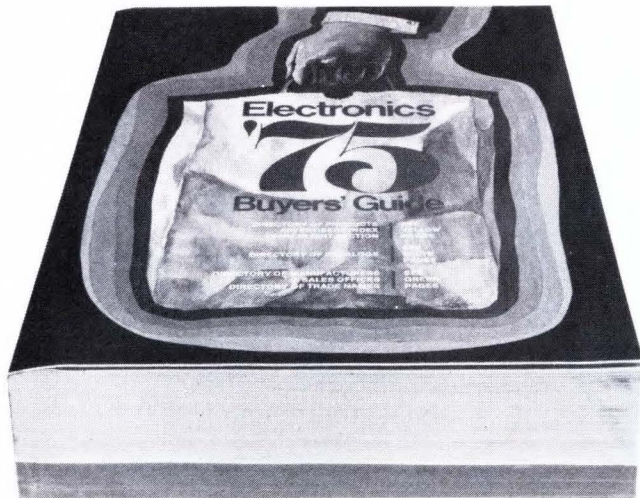

NEW ELECTRONICS BUYERS' GUIDE... EASY-TO-USE, SINGLE VOLUME SOURCE FOR:

- Information on over 4,000 products.
- Over 6,000 company listings and phone numbers – both home and field offices.
- **EBG EXCLUSIVE:** quick access to over 1000 helpful catalogs through a timesaving Direct Inquiry service.
- More than 1,400 pages of data.

Here is the international world of electronics at your fingertips. Find suppliers... fast... accurately... and locally! Don't have a copy? Use coupon below, today.

Electronics Buyers' Guide

A McGraw-Hill Publication

1221 Ave. of the Americas, New York, N.Y. 10020

Yes, send me _____ copies (copy) of the energy saving Electronics Buyers' Guide. I've enclosed \$20.00 (USA and Canada only; elsewhere send \$30.00). Full money back guarantee if not satisfied.

NAME _____

COMPANY _____

STREET _____

CITY _____

STATE _____ ZIP _____

The New Brush 2400: the best performing, most versatile wide channel recorder you can buy.

It is available in 2, 3 and 4 channel configurations utilizing combinations of 50 mm and 100 mm channels totalling 200 mm. It had a 99.65% linearity over the full 100 mm channel. Its frequency response is an outstanding 30 Hz at 100 mm, 50 Hz at 50 mm and up to 125 Hz less than 3dB down. It has a full range of plug-in signal conditioners for just about any industrial-scientific-medical application.

For full details on why the new Gould 2400 is the best performing direct writing recorder you can buy, write Gould Inc., Instrument Systems Division, 3631 Perkins Avenue, Cleveland, Ohio 44114. Or Kouterveldstraat 13, B 1920 Diegem, Belgium.

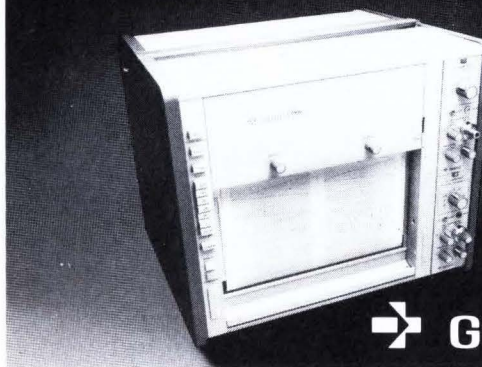

 **GOULD**

Circle 127 on reader service card

PHILIPS

Get rid of REELS...

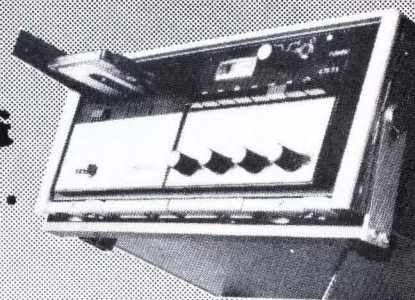

Go 'REAL' COMPACT!!

Have real portability, real ease of operation and real reliability with the new Philips COMPACT ANALOG instrumentation recorder. The MINI-LOG 41

- Compact: W: 10.8", H: 5.3", D: 10.6"
- Less than 30 pounds
- Speech facility
- S/N ratio up to 42 dB
- Playing time @ 3/4 ips = 100 minutes
@ 7 1/2 ips = 10 minutes
- 4 channels FM
- Frequency ranges 0 - 2500 Hz or 0 - 5000 Hz
- AC/DC operation (12 VDC cable included)
- 5000 hours warranted heads and motors

• SPECIAL APPLICATIONS INFORMATION ' HOT LINE
DIAL TOLL FREE NUMBER (800) 645-3043
NEW YORK STATE, CALL COLLECT (516) 921-8880

Philips Test & Measuring Instruments, Inc.

A NORTH AMERICAN PHILIPS COMPANY

Circle 152 on reader service card for either a salesman to call or for a demonstration.



INTERNATIONAL'S
moe
**CRYSTAL OSCILLATOR
 ELEMENTS**

A Complete Controlled Signal Source from 6000 KHz to 60 MHz

The MOE series is designed for direct plug-in to a standard dip socket. The miniature oscillator element is a complete source, crystal controlled, in an integrated circuit 14 pin dual-in-line package with a height of 1/2 inch.

Oscillators are grouped by frequency and temperature stability thus giving the user a selection of the overall accuracy desired. Operating voltage 3 vdc to 6 vdc.

TYPE	CRYSTAL RANGE	OVERALL ACCURACY	25°C TOLERANCE	PRICE
MOE-5	6000KHz to 60MHz	+ .002% -10° to +60°C	Zero Trimmer	\$35.00
MOE-10	6000KHz to 60MHz	+ .0005% -10° to +60°C	Zero Trimmer	\$50.00

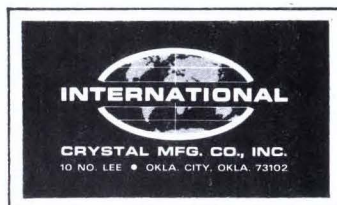

New products

which includes two probes and a front cover. The 28-pound portable instrument is noteworthy for its ease of operation. Each of its front-panel push buttons has a single function that is activated when the button is depressed. This eliminates all the confusion that can result when buttons have one function when depressed and another when released. The scope has been designed with plug-in circuit boards and plug-in active devices for ease in servicing.

Dumont Oscilloscope Labs. Inc., 40 Fairfield Pl., West Caldwell, N. J. 07006 [356]

3-digit panel meters have resistor-programmed gain

A series of "universal" digital panel meters is programmed by means of an external resistor to sensitivities as high as 50 microvolts per count. Because of this programability, users need stock only one model to accommodate a wide range of applications that need a three-digit instrument. Available in models that use gas-plasma and light-emitting-diode displays, the AN2530 series runs on 5 volts dc and consumes less than 3 watts. The price of the meters, in hundreds, is \$62 each.

Analogic, Audubon Rd., Wakefield, Mass. 01880 [357]

Adjustable bandpass filter has fixed mid-band gain

A narrow-band (high-Q) active filter is expected to find important applications in spectrum analysis, distortion measurements, and similar areas in which it is necessary to examine a very narrow band of frequencies. Capable of being tuned to center frequencies from 0.1 Hz to 10 kHz, the model 301 maintains a constant gain at the center frequency, independent of frequency and Q. The Q control can be set from Q=5 to Q=100. The price of the 301 is \$650; deliveries take two weeks.

A. P. Circuit Corp., 865 West End Ave., New York, N. Y. 10025 [358]

New literature

Crystal oscillators. An applications bulletin entitled "How to Specify Crystal Oscillators" covers clock, temperature-compensated, and ovenized oscillators. The eight-page booklet discusses the operation of each type of oscillator, and goes into such applications considerations as initial accuracy, temperature drift, long-term drift (aging), and supply variations. The booklet can be obtained from Vectron Laboratories Inc., 121 Water St., Norwalk, Conn. 06854. Circle 421 on reader service card.

High-temperature ferrites. Design Guide No. 143 includes design examples, test circuits, 24 nomographs, and specifications of the IR 8200 series of inverter-rated ferrite components. Available as E cores, U cores, pot cores, cross cores, and toroids, the IR 8200 line reaches its maximum efficiency at 120°C. The 40-page design guide is available from Indiana General, Electronic Products, Keasbey, N. J. 08832 [422]

Balanced mixers. A 12-page applications bulletin (MO702-37) covers a family of hybrid balanced mixers, biased and unbiased, in octave and wider bandwidths from 0.5 to 18 GHz. The bulletin is put out by Anaren Microwave Inc., 185 Ainsley Dr., Syracuse, N. Y. 13205 [423]

Switches and relays. A comprehensive engineering manual which discusses the theory and applications of various types of reed switches and relays—with special emphasis on the static and dynamic characteristics of their contacts—is available from Gordos Corp., 250 Glenwood Ave., Bloomfield, N. J. 07003 [424]

Microwave voltage-controlled oscillators. Published by Frequency Sources Inc., 166 Middlesex St., North Chelmsford, Mass. 01863, a 24-page brochure provides a detailed review and comparison of microwave VCOs and discusses loading effects, noise, and other critical parameters which affect their performance [425]

BODINE TRAN-BAL[®] Fluorescent Lighting From D.C. Power

- Transistorized inverter ballast for operating fluorescent lamps from low voltage D.C. current.
- Designed for applications requiring long life, reliability and efficiency.
- Models can be synchronized to prevent beat notes between lamps in multiple lamp installation.
- Rapid start and instant start models from 4 to 40 watts.
- Eliminate lamp flicker with high frequency operation.
- Protection against reverse polarity available.
- Replaceable transistors and in line fuses.
- Solves many photo electric problems.

BODINE CO.

MANUFACTURERS OF ELECTRONIC EQUIPMENT
236 MT. PLEASANT ROAD • COLLIERVILLE TENNESSEE 38017
Area Code 901/853-7211

Circle 129 on reader service card

Your line needs our line.

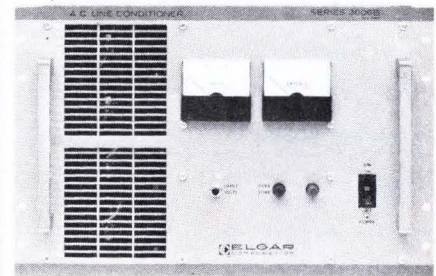
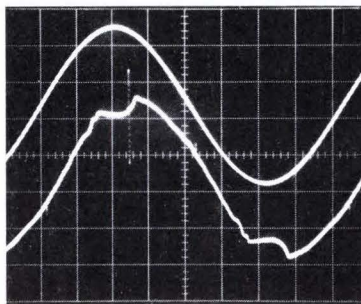

If your line is feeding a computer, the electronics are probably getting an unbalanced diet. The lower curve is an actual scope display of AC line power. The upper curve shows how an Elgar Line Conditioner smoothed out the transients and distortion. And it did it quickly—about 5,000 times as quickly as a line regulator. Elgar Line Conditioners have an impulse settling time of less than 20 μ sec. They provide $\pm 0.025\%$ load regulation and reduce 500 V 10 μ sec. transients by 1000:1. Instruments are available in 1, 3 and 5 KVA versions. For more information, contact Elgar Corporation, 8225 Mercury Court, San Diego, California 92111. Phone (714) 565-1155.

ELGAR
Elgar also is a leading producer
of Uninterruptible Power Systems
and AC Power Sources

Electronics advertisers

March 6, 1975

Addmaster Corporation Mich Associates	111	Elger Corp. Chapman Michetti Advertising	129	* Seimart CPM Studio	23E
* Adelsy C.E.T.I.	21E	* English Electric Valve Co. Ltd. The London Advertising Partnership	8E-9E	* Sescosem Bazine Publicite	7E, 27E, 46
Ad-Vance Magnetics, Inc. Burton Browne Advertising	111	■ Erie Technological Products Co., Inc. Altman Hall Associates Advertising	21	SGS-ATES-International McCann-Erickson	67
Advanced Micro Devices Keye Donna Pearlstein	11	Fibra Sonics, Inc. Division of C.E. Niehoff The Gnsword + Eshleman Company	114	Siemens Components Division N.A. Winter Advertising Agency	12
■ Airpax Electronics, Inc. Group Three Advertising Corporation	16	■ Fluke Manufacturing Co., John Bonfield Associates	24, 115	* Siemens Karlsruhe Linder Presse Union	44
Aluminum Company of America-Chemicals Ketchum, MacLeod & Grove, Inc.	106	* Gardner Denver Company Buchen Advertising Inc.	28	* Silec Mexim	2E
American Microsystems, Inc. Wilton Coombs & Colnett, Inc., Advertising	63	GENERAL RADIO Company Grad Associates	86	* Sodeco SAIA Stocker	19E
American Used Computer Corporation McDavitt Advertising	131	■ Gould Inc./Instrument Systems Division Carr Liggett Advertising, Inc.	127	* Spectrol Reliance Limited JMR Advertising	14E-15E
Amperex Electronic Corporation Sam Groden, Incorporated	31	■ Grayhill, Inc. Stral Advertising Company, Inc.	70	Sprague Electric Company Harry P. Bridge Company	8
Bausch & Lomb, Inc. Wolf Associates, Inc.	62	■ Heath/Schlumberger Scientific Instruments Advance Advertising Services	110	Systron Donner Concord Instruments Fred Schott & Associates	9, 120
‡ Bell & Howell—Electronics & Instruments Group CEC/Instruments Division	28	■ Hewlett-Packard Tallant/Yates Advertising, Inc.	52-53	Tally Corporation Bonfield Associates	122
Bodine Company, The Tech-Nik	129	■ Hewlett-Packard Bozell & Jacobs/Pacific	1, 71	■ Tansitor Electronics Devey, Thompson & Vignola Advertising, Inc.	6
Bonton Electronics Corporation Sommer Agency, Inc.	123	Houston Instruments Ray Cooley and Associates, Inc.	116	■ TEC, Inc. TEC-AD	115
‡ Busmann Mfg. Division of McGraw-Edison Henderson Advertising Company	43	Intel Corporation Regis McKenna, Inc.	18-19, 39	■ Technipower Division of Benrus Corporation Freeman Pratt Barrows Advertising Associates	126
California Computer Products Dailey & Associates Advertising	109	International Crystal Manufacturing Company Robert V. Freeland & Associates	128	* Tekelec Aitronic S.P.F.D.	30E
■ Cambridge Thermionic Corporation Chirurg & Cairns, Inc.	84	ITT Semiconductors Hall & McKenzie Advertising	40	Tekelec, Inc. Art Wroebel Company	115
Cherry Electrical Products, Corp. Kolb/Tookey & Associates, Inc.	56	Kelthley Instruments Chagrin Valley Marketing Associates	112	Teledyne Semiconductor Regis McKenna, Inc.	7
■ Chicago Dynamic Industries Burton Browne Advertising	110	Krohn-Hite Corporation Impact Advertising, Inc.	5	Teradyne, Inc. Quinn & Johnson, Inc.	35
Computer Automation Cochrane Chase & Company, Inc.	16A, B, C, D	Kurz-Kasch, Incorporated David K. Burnap Advertising	110	■ Texas Instruments Incorporated, Learning Center Tracey-Locke, Inc.	125
Cramer Division of Conrac McCarthy, Scelba, DeBlasi Advertising Agency	61	* Marconi Instruments Limited Russell Powell Advertising Limited	5E	Thermalloy Advertising Graphics	10
■ Dale Electronics Inc., A Sub. of the Lionel Corporation Swanson, Sinkey, Ellis, Inc., Advertising	4th Cover	Microsystems International Limited Mil Advertising	118-119	* Tokyo Sokuhan Co., Ltd. Showa Advertising Service, Inc.	31E
Datatron, Inc. Larry Courtney Company	2nd Cover	National Cash Register Stahlka/Faller, Inc.	3rd Cover	Trompeter Electronics, Inc. Diamond Advertising Agency	122
Datatron-Tester Division Larry Courtney Company	15	■ Newport Labs. Manning/Bowen and Associates	6	■ TRW/Capacitors Gray & Rogers, Inc.	73
Deutsche Messe AG Hannover Wilkins WPT	99	* Norton Technik Marketing	32E	■ Union Carbide Corporation J.J. Lane, Inc.	17
■ Diallight Corporation Michel-Cather, Inc.	20	* Oscilloquartz SA, Neuchatel Publicitas Service International	32E	■ Union Carbide Corporation— Components Department McConnell-Downs	49
Digital Equipment Corporation Creamer, Trowbridge, Case & Basford, Inc.	69, 54-55	* Phillips Industries Vaz Dias	10E-11E	United Systems Corp. A sub. of Monsanto Company Advertising & Merchandising, Inc.	71
Dinges Elektronik GmbH	120	Phillips Test & Measuring Instruments, Inc. G.A.D.	127	■ Unitrode Corporation Schneider Parker, Inc.	27
Divs, Inc. Halloff & Caine	2	Photocircuits Ries Cappiello Colwell, Inc.	50-51	Varo Semiconductor Inc. Warren-Guild	131
Ducati Elettrotecnica Microfarad Studio Busoli Gastone	28E	Pro-Log Corporation Tycker-Fultz	96	* Wavetek San Diego, Inc. Chapman Michetti Advertising	43
EECO The Greer Agency	93	RCA—Solid State Division Marsteller, Inc.	59	* Wild Heerbrugg Public Relations & Werbe AG	25E
■ Electronics Navigation Industries Hart/Conway Advertising— Public Relations	14	‡ Rental Electronics, Inc. Humphrey Browning MacDougall, Inc.	46	Willtron Company Frank Burkhard Company	122
Electronic Measurements, Inc. Hill Advertising Agency	72	Reticon Corporation The House Agency	68	* La Zincoelere S.p.a. Studio Dr. Giuliano Blei	12E
* Electronic Product News	29E	Robinson Nugent, Inc. Kolb/Tookey & Associates, Inc.	22-23		
Electronic Research Company ERC Advertising	74	* Rohde & Schwarz	1E		
		* S.A.F.T. U.N.C.C.	17E		

‡ For more information on complete product line see advertisement in the latest Electronics Buyer's Guide
* Advertisers in Electronics International
‡ Advertisers in Electronics domestic edition

RENT A MINI

1 DAY DELIVERY

DEC PDP 8I(4K)

DEC PDP 8L(8K)

ASR 33

FOR SALE

MINIS DEC • DG • CAI • GTE
HP • HIS • IBM • INT
LOCK • MICRO • SEL
VARIAN • XLO

PRINTERS MDS 4330 \$3950

CDC 9322 — \$2500

DP 2440 — \$7500

CARD DOC M200 \$950

READERS GDI 100, 110 \$750

PAPER DIGITRONICS

TAPE CHALCO • BRPE

MAG PERTEC • WANGCO

TAPE POTTER • AMPEX

617-261-1100

AMERICAN USED COMPUTER CORP.

P.O. Box 68, Kenmore Sta., Boston, MA 02215
member COMPUTER DEALERS ASSOCIATION

Circle 155 on reader service card

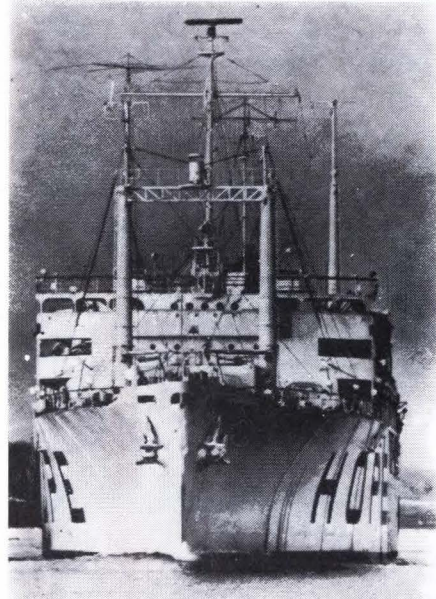

S.S. HOPE, M.D.

Doctor . . . teacher . . . friend to
millions on four continents—
this floating hospital is a
symbol of America's concern
for the world's disadvantaged.

Keep HOPE sailing.

PROJECT HOPE

Dept. A, Washington, D.C. 20007

Advertising Sales Staff

Pierre J. Braudé New York [212] 997-3468
London 01-493-1451
Director of Marketing

Atlanta, Ga. 30309: Warren H. Gardner
100 Colony Square, 1175 Peachtree St., N.E.
[212] 997-3617

Boston, Mass. 02116: James R. Pierce
607 Boylston St. [617] 262-1160

Chicago, Ill. 60611:
645 North Michigan Avenue
Robert W. Bartlett (312) 751-3739
Paul L. Reiss (312) 751-3738

Cleveland, Ohio 44113: William J. Boyle
[716] 586-5040

Dallas, Texas 75201: Charles G. Hubbard
2001 Bryant Tower, Suite 1070
[214] 742-1747

Denver, Colo. 80202: Harry B. Doyle, Jr.
Tower Bldg., 1700 Broadway
[303] 266-3863

Detroit, Michigan 48202: Robert W. Bartlett
1400 Fisher Bldg.
[313] 873-7410

Houston, Texas 77002: Charles G. Hubbard
375 Dresser Tower, 601 Jefferson St. [713] CA 4-8381

Los Angeles, Calif. 90010: Robert J. Rielly
Bradley K. Jones, 3200 Wilshire Blvd., South Tower
[213] 487-1160

New York, N.Y. 10020
1221 Avenue of the Americas
Warren H. Gardner [212] 997-3617
Michael J. Stoller [212] 997-3616

Philadelphia, Pa. 19102: Warren H. Gardner
Three Parkway,
[212] 997-3617

Pittsburgh, Pa. 15222: Warren H. Gardner
4 Gateway Center, [212] 997-3617

Rochester, N.Y. 14534: William J. Boyle
9 Greylock Ridge, Pittsford, N.Y.
[716] 586-5040

San Francisco, Calif. 94111: Don Farris
Robert J. Rielly, 425 Battery Street,
[415] 362-4600

Paris: Alain Offergeld
17 Rue-Georges Bizet, 75 Paris 16, France
Tel: 720-73-01

Geneva: Alain Offergeld
1 rue du Temple, Geneva, Switzerland
Tel: 32-35-63

United Kingdom & Scandinavia: Keith Mantle
Tel: 01-493-1451, 34 Dover Street, London W1

Milan: Luigi Rancati
Robert Saidel (Middle East)
1 via Baracchini, Italy Phone 86-90-656

Brussels: Alain Offergeld
23 Chaussee de Wavre
Brussels 1040, Belgium
Tel: 13-73-95

Frankfurt/Main: Fritz Krusebecker
Dieter Rothenbach (East European Countries)
Liebigstrasse 27c, Germany
Phone 72 01 81

Tokyo: Tatsumi Katagiri, McGraw-Hill
Publications Overseas Corporation,
Kasumigaseki Building 2-5, 3-chome,
Kasumigaseki, Chiyoda-Ku, Tokyo, Japan
[581] 9811

Australasia: Warren E. Ball, IPO Box 5106,
Tokyo, Japan

Business Department

Stephen R. Weiss, Manager
[212] 997-2044

Thomas M. Egan,
Assistant Business Manager [212] 997-3140

Carol Gallagher
Production Manager International [212] 997-2045

Dorothy Carter, Production Manager Domestic
[212] 997-2908

Frances Vallone, Reader Service Manager
[212] 997-6057

Lisa Hoenig, Secretary
[212] 997-6481

Electronics Buyers' Guide

George F. Werner, Associate Publisher
[212] 997-3139

Regina Hera, Directory Manager
[212] 997-2544

Schottky Barrier Rectifiers



- Four series: 1A, 3A, 5A and 15A (I_o) with 20V and 30V (V_{RRM}).
- Extremely fast recovery (t_{rr}), very low forward voltages (VF), high reliability and low cost.
- VSK 120 & 130-1A series in DO-41 packages. 450 & 550 mV (VF). 40A peak $\frac{1}{2}$ cycle surge (I_{FSM}). 10 mA (I_R) at 100°C.
- VSK 320 & 330-3A series. Epoxy package, axial leads. 475 & 500 mV (VF). 150A surge. 30 mA (I_R) at 100°C.
- VSK 520 & 530-5A series. Epoxy package, axial leads. 380 mV (VF). 250A surge. 75 mA (I_R) at 100°C.
- VSK 1520 & 1530-15A series in DO-4 metal stud cases. 550mV (VF). 300A surge. 75 mA (I_R) at 100°C.
- All series have junction operating temperature range of -65°C to +125°C.
- Typical pricing, 1000 qntys, from \$1.38 ea. (VSK 120) to \$3.67 ea. (VSK 1530).

Call Charlie Merz 214/272-4551
for complete information

WRITE ON
YOUR LETTERHEAD FOR
FREE SAMPLES.



VARO

VARO SEMICONDUCTOR, INC.

P.O. BOX 676, 1000 NORTH SHILOH,
GARLAND, TEXAS 75040
(214) 272-4551 TWX 910-860-5178

FEATURE ARTICLES FROM ELECTRONICS MAGAZINE ARE NOW AVAILABLE IN REPRINT FORM!

Valuable additions to your electronics library are now available thru this exclusive reprint service. Just check the articles you wish to order and enclose check or money order for prompt service.

No. of Copies Wanted		No. of Copies Wanted	
_____	R- 11 Computer-Aided Design	_____	R-310 Penetration Color Tubes are Enhancing Information Displays
_____	R- 15 Special Report on LSI Packaging	_____	R-312 Leadless, Pluggable IC Packages Reduce Costs
_____	R-016 Special Report on The Transistor: Two Decades of Progress	_____	R-316 Hybrid Circuit Technology Solves Tough Design Problems
_____	R- 18 Reshaping the EE for the Seventies	_____	R-318 Buckling Up for the Bumpy Road to Detroit
_____	R-023 Special Report: Tomorrow's Communications	_____	R-320 Planar Interconnection Techniques (Designer Must Plan Early for Flat Cable)
_____	R-027 Consumer Hazards: Why They Happen, How They Can Be Fixed	_____	R-322 Special Report: The New Displays Complement the Old
_____	R-031 Circuit Designer's Casebook (U.S. Only)	_____	R-324 Semiconductor Memories Are Taking Over Data-Storage Applications
_____	R-032 Active Filters	_____	R-326 Optical Spectrum Report and Optical Spectrum Chart
_____	R-033 Infra-Red Detector Chart	_____	R-328 Pervasiveness of Electronics Entire Issue of Electronics
_____	R-101 Special Report: The Right Numeric Readout, a Critical Choice for Designers	_____	R-400 Japanese Forecast 1974
_____	R-104 The New Concept for Memory and Imaging: Charge Coupling	_____	R-402 European Forecast 1974
_____	R-107 Wanted for the '70s: Easier-to-Program Computers	_____	R-404 U.S. Forecast 1974
_____	R-110 Automation for Survival and Profit	_____	R-406 Logics New Design Tools
_____	R-113 Optoelectronics Makes It At Last (3 part series)	_____	R-408 Bringing Sight to the Blind
_____	R-203 East Europe Market Report	_____	R-410 Passive Components
_____	R-205 Bridging the Analog & Digital Worlds with Linear ICs	_____	R-412 Liquid Cooling Semiconductors
_____	R-207 Technology Gap Starts to Close for Computer Peripherals	_____	R-414 Simplified n-Channel Process
_____	R-209 Semiconductor RAMs Land Computer Mainframe Jobs	_____	R-416 Optical Waveguides Look Brighter
_____	R-211 Electromagnetic Spectrum Report and Foldout Chart	_____	R-418 Computer Analyses of RF Circuits
_____	R-213 Electromagnetic Spectrum Chart (rolled in mailing tube)	_____	R-420 Computerized Text-Editing and Typesetting
_____	R-306 Charge Coupling Improves Its Image, Challenging Video Camera	_____	R-422 A Microprogrammable Minicomputer
_____	R-308 Program for Transition from NonLinear to Linear Transistor Model	_____	R-424 Microprocessor Applications
		_____	R-426 Special Issue—Technology Update—1974

Payment must accompany your order... USE THIS PAGE AS YOUR ORDER FORM

Make check or money order payable to Electronics Reprints. All orders shipped prepaid via parcel post. Allow two to three weeks for delivery.

Back Issues Now Available. 1960 to 1969 \$5.00 each. 1970 to 1973 \$3.00 each.

Mail Your Order To
Janice Austin
ELECTRONICS REPRINTS
P.O. Box 669
Hightstown, N.J. 08520

Amount of Order	\$ _____
Plus 10% Handling Charge	\$ _____
TOTAL AMOUNT ENCLOSED	\$ _____

SEND REPRINTS TO

Name _____
Company _____ Dept. _____
Street _____
City _____ State _____ Zip _____