

AUGUST 5, 1976

**WHAT'S LEFT FOR RECEIVING-TUBE MAKERS?/67**

How instrument users view the universal interface bus/70

A hardware approach to debugging microprocessors/106

LIBRARY  
STATE TECHNICAL INSTITUTE  
AT MEMPHIS

FOUR DOLLARS A MCGRAW-HILL PUBLICATION

# Electronics®

STATE TECHNICAL INST  
FREEMAN LIBRARY 017823  
5983 MACON COVE  
MEMPHIS TN  
38134

OPTICAL  
COMMUNICATIONS  
ITS TIME HAS COME



PURDY

# BRAND-REX TAPE CABLE<sup>®</sup> - SOMETHING FLAT TO ROUND OUT THE BROADEST LINE IN THE INDUSTRY.

TAPE CABLE is a flat, flexible cable — the newest addition to the long line of Brand-Rex cables which already include bonded and woven ribbon cable, insulated copper and aluminum strip for power distribution, and a wide range of standard round configurations.

TAPE CABLE is produced in a new Brand-Rex facility in Manchester, Conn. It is available in an almost endless variety of constructions:

- Round or flat conductors, solid or stranded, bare or plated — drawn in-house to permit precise tolerance control.

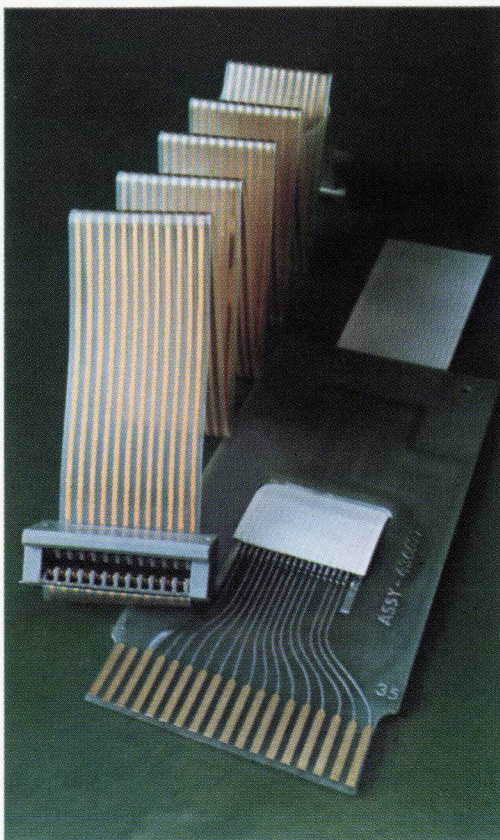

TAPE CABLE can be supplied in bulk or as assemblies. Brand-Rex's well-known design capability is yours to draw on. Where necessary, we will design TAPE CABLE systems consisting of cables terminated to printed wiring boards, connectors or flexible printed circuits for your particular application.

For complete information, send for the new Brand-Rex TAPE CABLE brochure. Brand-Rex Company, Electronic and Industrial Cable Division, Willimantic, Ct. 06226, 203/423-7771.

- From 1 to 200 conductors — the same or mixed cross-sections and sizes.
- Many insulation types, including PVC, polyester, Kapton\*, Teflon\*.
- Unshielded, or shielded on one or both sides.
- Controlled spacings to meet any electrical or mechanical requirement.
- Signal cables for digital data transmission in computers.

\*Dupont Trademark

## BRAND-REX

ELECTRONIC & INDUSTRIAL CABLE DIVISION

Other Brand-Rex Divisions:

Abbott & Co., wiring harnesses □ Nonotuck Manufacturing Co., copper wire  
Pyle-National Co., electrical connectors □ Telecommunications Cable Division  
Teltronics, Inc., telephone equipment and components □ Brand-Rex, Ltd. (Scotland), wire and cable.

BRAND-REX CO., A PART OF ALZONA INCORPORATED

Circle 900 on reader service card

# Oscilloscope Measurements Then vs. Now

If you've been making scope measurements like this...

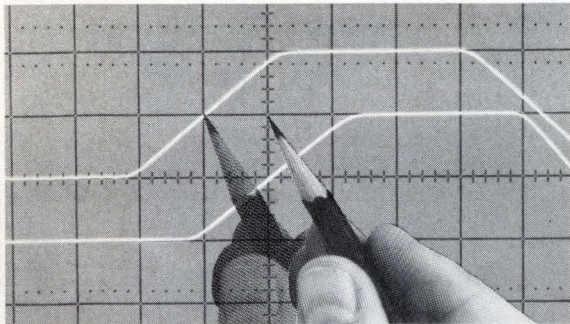

1. Counting divisions

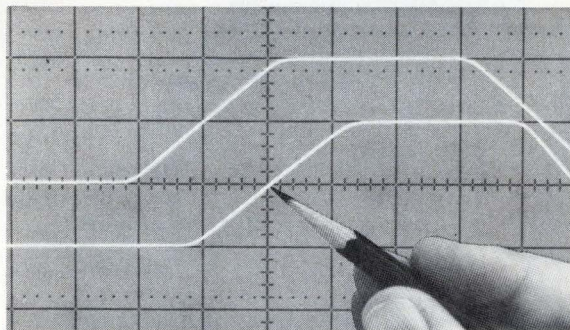

2. Interpolating between divisions



3. Checking the time base scale-factor

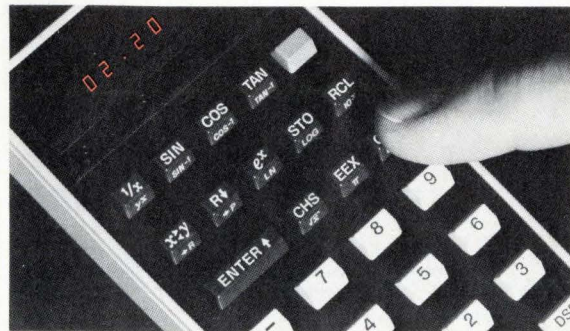

4. Multiplying by volts/div or time/div.  
In this case,  $1.1 \text{ div} \times 2 \mu\text{sec/div} = ?$

Electronics/August 5, 1976

Now HP's direct reading 1722A automatically monitors scale-factor settings and calculates results. Just...

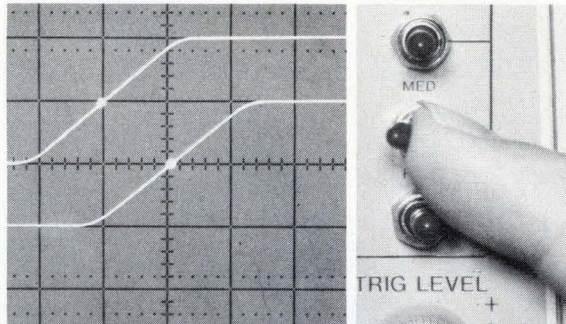

1. Position intensified markers (or adjust position controls for voltage measurements)

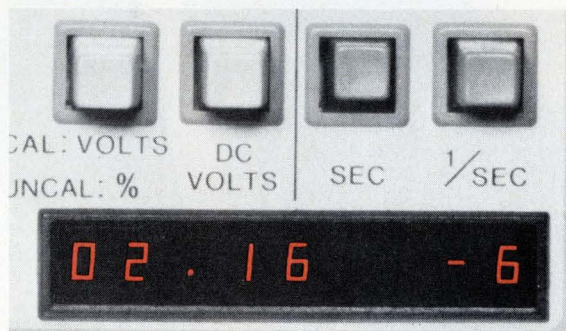

2. Take readings directly

With the 1722A, it's just that easy to get direct readings of propagation delay, pulse width, instantaneous voltage, rep. rate, percent overshoot and frequency of ringing. And if you're making delayed sweep measurements, the comparison is even more dramatic. In addition to saving time, HP's dual-trace 275 MHz 1722A significantly improves repeatability and accuracy.

Find out how the 1722A, priced at \$4,900\*, simplifies and speeds almost any scope measurement. Send for the data sheet and application notes. Or contact your local HP field engineer.

\* Domestic U.S.A. price only.



HEWLETT **hp** PACKARD

Sales and service from 172 offices in 65 countries.

1507 Page Mill Road, Palo Alto, California 94304  
For assistance call Washington (301) 948-6370, Chicago (312) 677-0400,  
Atlanta (404) 434-4000, Los Angeles (213) 877-1282, Toronto (416) 678-9430

Circle 1 on reader service card

# SURPRISE!



## High Speed, High Reliability, High Gain Isolators from Hewlett-Packard!

Hewlett-Packard now offers you a broad family of high-performance optically-coupled isolators. These devices are ideal for telephone, computer, medical, process control and instrumentation applications. Our high-speed isolators can handle data at a rate of up to 10 Mbits per second. The high-reliability isolator is a dual-channel unit, hermetically sealed. Our high-gain, low-input isolator requires 0.5 mA of input. And, best of all, they are all in stock at any of our franchised distributors.

In the U.S., contact Hall-Mark, Schweber, Wilshire or the Wyle Distribution Group (Liberty/Elmar) for immediate delivery. In Canada, contact Bowtek Electronics Co., Ltd., Schweber Electronics or Zentronics, Ltd.

It's time to get to know Hewlett-Packard's family of high-performance isolators.

**HEWLETT**  **PACKARD**

Sales and service from 172 offices in 65 countries.  
1507 Page Mill Road, Palo Alto, California 94304

## 31 Electronics Review

PACKAGING & PRODUCTION: Copper tape set to carry IC chips, 31  
MEDICAL: Respiration rate cues heart pacemaker, 32  
IEEE: U.S. activities board releases its game plan, 32  
CONSUMER: IFL camera shutter control needs no battery, 33  
Zenith only set maker to adopt new color tube for TV line, 34  
MILITARY: Avionics for CP-140 to top \$200 million, 36  
B-1 electronic countermeasures gear begins tests, 36  
NEWS BRIEFS: 38  
SPACE: Problems slight on Viking mission to Mars, 40  
CAREERS: EEs wanted: \$50 reward, 43

## 53 Electronics International

JAPAN: Matsushita's MOS image sensor cancels spurious signals, 53  
AROUND THE WORLD: 53

## 67 Probing the News

COMPONENTS: Little left of receiving-tube market, 67  
INSTRUMENTATION: Standard interface gains fans, 70  
COMPANIES: For ITT, staying at home pays, 74  
MILITARY ELECTRONICS: Slimmer Samso maintains strength, 78

## 81 Technical Articles

SPECIAL REPORT: Fiber-optic developments spark interest, 81  
ENGINEER'S NOTEBOOK: Multimeter shows model parameters, 106  
Spectrum analyzer aids fm deviation measurement, 107  
Scope-triggered register freezes serial data, 108  
DESIGNER'S CASEBOOK: Circuit steps program to debug 8080, 110  
C-MOS reset circuit ignores brief outages, 111  
Timer IC paces analog divider, 112

## 117 New Products

IN THE SPOTLIGHT: Calculator runs transceiver tester, 117  
New designs reduce prices of solid-state relays, 120  
COMPONENTS: Transformer isolates 20 kilovolts, 124  
PACKAGING & PRODUCTION: Chip inspection is simplified, 129  
SEMICONDUCTORS: Optical gate reduces components count, 132  
INSTRUMENTS: 32-channel tester analyzes microprocessors, 136  
MATERIALS: 141

## Departments

Publisher's letter, 4  
Readers' comments, 6  
News update, 8  
Editorial, 12  
People, 14  
Meetings, 20  
Electronics newsletter, 25  
Washington newsletter, 49  
Washington commentary, 50  
International newsletter, 55  
Engineer's newsletter, 114

## Highlights

### COVER: The rising star of fiber optics, 81

A number of small optical-communications systems have gotten off the ground, thanks to the growing availability and improved performance of optical-fiber cable, light sources, photodetectors, and connectors. But a major system must start construction before the market can seriously begin its climb to the billion-dollar level forecast for 1990.

Cover illustration is by Dennis Purdy.

### OPTICAL FIBERS: Cables grow stronger, 88

High-performance cable is guaranteed not to fail at its rated tensile strength.

### Users can check cable parameters, 90

Simple tests enable users to measure stress levels and numerical aperture.

### SOURCES: LEDs respond linearly, 92

High-radiance light-emitting diodes are the best choice for analog applications.

### Laser diodes have high output power, 94

Laser sources couple light into optical fiber with greater efficiency than LEDs.

### CONNECTIONS: Alignment is critical, 96

For low optical loss, connectors and splices require precise axial alignment.

### What to look for in metal connectors, 98

Fiber preparation and alignment differ for single-fiber and bundle-fiber devices.

### Plastic design handles many cable sizes, 100

Bushing lets fiber bundle be quickly polished after assembly to connector.

### DETECTORS: P-i-n photodiodes lead, 101

Low-cost devices are less noisy than photo-transistors or avalanche diodes.

### COUPLING: Star couplers play big role, 102

Star couplers do better than "tee" types in systems with 20 or more terminals.

### And in the next issue . . .

The many uses of optical isolation amplifiers . . . a high-performance version of the popular 8080 microprocessor.

EDITOR-IN-CHIEF: Kemp Anderson

EXECUTIVE EDITOR: Samuel Weber

MANAGING EDITOR: Arthur Erikson,  
*International*

SENIOR EDITORS: Laurence Altman,  
Ray Connolly, Lawrence Curran,  
John Johnsrud, H. Thomas Maguire,  
Stephen E. Scrupski

ART DIRECTOR: Fred Sklenar

ASSOCIATE EDITORS: Howard Wolff,  
Gerald M. Walker, Alfred Rosenblatt

DEPARTMENT EDITORS  
*Aerospace/Military*: Ray Connolly  
*Circuit Design*: Don Blattner  
*Communications & Microwave*:

Richard Gundlach  
*Components*: Lucinda Matterna  
*Computers*: Stephen E. Scrupski  
*Consumer*: Gerald M. Walker  
*Industrial*: Margaret A. Maas  
*Instrumentation*: Andy Santoni  
*New Products*: H. Thomas Maguire,  
Michael J. Riezenman

*Packaging & Production*: Jerry Lyman  
*Solid State*: Laurence Altman

CHIEF COPY EDITOR: Margaret Eastman

COPY EDITORS: Everett C. Terry, Ben Mason

ART: Charles D. Ciatto, *Associate Director*

EDITORIAL SECRETARIES: Janet Noto,  
Julie Gorgoglione, Penny Roberts

FIELD EDITORS

*Boston*: Lawrence Curran (Mgr.), Pamela Leven

*Los Angeles*: Larry Waller (Mgr.)

*Midwest*: Larry Armstrong (Mgr.)

*New York*: Bruce LeBoss (Mgr.)

*San Francisco*: Bernard Cole (Mgr.)

Judith Curtis

*Washington*: Ray Connolly (Mgr.)

*Frankfurt*: John Gosch

*London*: William F. Arnold

*Paris*: Arthur Erikson

*Tokyo*: Charles Cohen

McGRAW-HILL WORLD NEWS

*Editor*: Michael Johnson

*Brussels*: James Smith

*Madrid*: Dom Curcio

*Milan*: Andrew Heath

*Moscow*: Peter Gall

*Paris*: Joel Stratte-McClure

*Stockholm*: Robert Skole

*Tokyo*: Colin Gibson

PUBLISHER: Dan McMillan

DIRECTOR OF MARKETING: Pierre J. Braudé

MARKETING ADMINISTRATION MANAGER:  
Wallis Clarke

CIRCULATION MANAGER: Nancy L. Merritt

MARKETING SERVICES MANAGER:  
Tomlinson Howland

RESEARCH MANAGER: Margery D. Sholes

Communicating from point to point along waveguides made of tiny optical fibers is no longer just an idea. It is rapidly becoming a practical method of pumping large quantities of data from place to place—especially in environments that are electrically noisy or already overcrowded with conventional cables.

On page 81, you'll find the beginning of a special report on optical-fiber communications. The 24-page special report consists of an overview of just what is happening now and nine articles covering components needed in a fiber-optic system.

The report was put together by our communications editor, Dick Gundlach, and the component articles were written by experts in the field. That's Dick, by the way, testing the strength of a new glass-fiber cable by tying knots in it, while Kenneth S. Kamm, of DuPont's PFX Fiber Optics Materials Research and Development division, demonstrates its impact resistance.

Says Dick: "A staff scientist at ITT Electro-Optical Products division, Roanoke, Va., Charles Kuen Kao, has been called the father of fiber optics. It was Kao who in 1966, then a research scientist at ITT's Standard Telecommunications Laboratories in England, speculated that if the losses were less than 20 decibels in fiber-optic waveguides they would find use in long-distance communications. He also projected that this would be possible by removing the impurities from glass. Even in 1968, though, fiber losses were as high as 1,000 dB/kilometer.

"The British Post Office then sponsored an effort to purify glass



and further explore the possibilities of optical-fiber waveguide communications. After that, interest spread worldwide. Bell Laboratories and Corning Glass Works in the U.S., Nippon Electric Co. and Nippon Sheet Glass Co. in Japan, and AEG-Telefunken and Siemens in Germany had projects going.

The big breakthrough came in 1970 when Corning announced that it had achieved what Kao had predicted. Physicists Robert Maurer, Donald Keck, and Felix Kapron along with chemist Peter Schultz of Corning had produced single-mode fibers in lengths several meters long with losses of under 20 dB/km.

"The next big advance—really low-cost fibers in large production quantities—is taking place outside of the lab. Corning's recent announcement of step-index fibers with a loss of less than 10 dB and bandwidth capabilities of 20 megahertz in minimum lengths of 1 km at \$1 per meter points out that both low cost and production capability in fibers is happening right now—just a decade after the idea."

August 5, 1976 Volume 49, Number 16  
95,997 copies of this issue printed

Published every other Thursday by McGraw-Hill, Inc. Founder: James H. McGraw 1860-1948. Publication office 1221 Avenue of the Americas, N.Y., N.Y. 10020; second-class postage paid at New York, N.Y., and additional mailing offices.

Executive, editorial, circulation and advertising addresses: Electronics, McGraw-Hill Building, 1221 Avenue of the Americas, New York, N.Y. 10020. Telephone (212) 997-1221. Teletype 12-7960 TWX 710-581-4879. Cable address: MCGRAWHILLNEWYORK.

Subscriptions limited to professional persons with active responsibility in electronics technology. Publisher reserves the right to reject non-qualified requests. No subscriptions accepted without complete identification of subscriber name, title, or job function, company or organization, and product manufactured or services performed. Subscription rates: in the United States and possessions \$12.00 one year, \$30.00 three years; Canada and Mexico \$14.00 one year, \$32.00 three years; Europe \$35.00 one year, \$87.50 three years; Japan, Israel and Brazil \$60 per year; Australia and New Zealand \$80.00 per year, including air freight; all other countries \$40.00 per year. Limited quota of subscriptions available at higher than basic rate for persons outside of field served, as follows: U.S. and possessions and Canada \$25.00 per year; Europe \$40.00; Japan, Israel and Brazil \$85.00; all other countries \$50.00. Single copies: \$4.00. Please allow four to eight weeks for shipment.

Officers of McGraw-Hill Publications Company: Gordon L. Jones, President; Paul F. McPherson, Executive Vice President; J. Elton Tuohig, Executive Vice President-Administration; Gene W. Simpson, Group Vice President; Senior Vice Presidents: Ralph Blackburn, Circulation; John B. Hoglund, Controller; Ralph R. Schulz, Editorial; David G. Jensen, Manufacturing; Vice Presidents: James E. Boddorf, Planning & Development; Edward E. Schirmer, Marketing Administration.

Officers of the Corporation: Harold W. McGraw, Jr., President, Chief Executive Officer, and Chairman of the Board; Robert N. Landes, Senior Vice President and Secretary; Ralph J. Webb, Treasurer.

Title registered in U.S. Patent Office; Copyright © 1976 by McGraw-Hill, Inc. All rights reserved. The contents of this publication may not be reproduced in whole or in part without the consent of copyright owner.

Subscribers: The publisher, upon written request to our New York office from any subscriber, agrees to refund that part of the subscription price applying to copies not yet mailed. Please send change-of-address notices or complaints to Fulfillment Manager; subscription orders to Circulation Manager, Electronics, at address below. Change-of-address notices should provide old as well as new address, including postal zip code number. If possible, attach address label from recent issue. Allow one month for change to become effective.

Postmaster: Please send form 3579 to Fulfillment Manager, Electronics, P.O. Box 430, Hightstown, N.J. 08520.

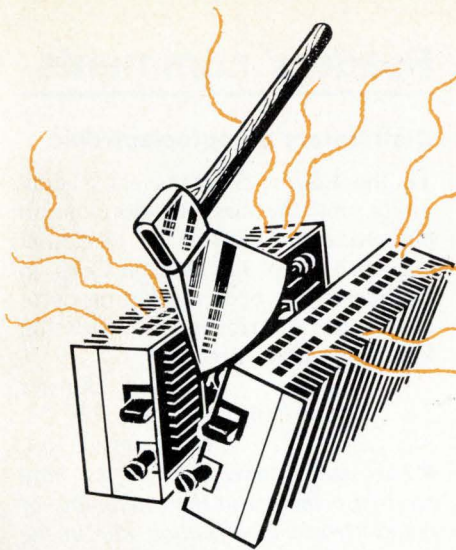

# don't settle for half a power supply at +60°C

or perhaps give up two thirds of  
the rating you bought as its  
temperature edges towards +70°C

We build power supplies with sufficient built-in heat exhaust capacity, that they require no external sinking whatever. They'll maintain their full rating right up to +71°C and, thanks to *internal* radiators, run their exterior *cool*. This conforms with IEC recommendations that discourage—for safety reasons—external fins that run hot to the touch.

The Kepco Group CPS Linear Power Supply Modules range from 100 watts to 1000 watts offering 0–6V and 0–15V fully adjustable, programmable outputs with rectangular (not fold-back) adjustable current limiting. A fast-acting overvoltage crowbar is built-in, linked to a double-pole on-off circuit breaker. The Kepco CPS is a precision stabilizer. A 100% load change produces less than 0.005% effect in the stabilized d-c voltage. Noise is suppressed well under 0.2 mV rms (2 mV p-p measured to 10 MHz) and recovery from a step-load or impulse load is complete in less than 50 microseconds.

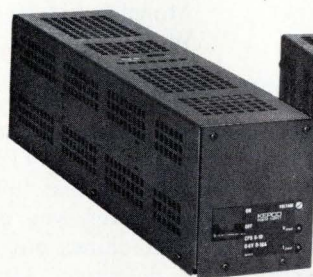

100W Module

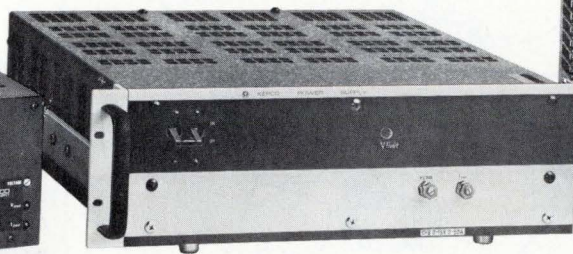

1000W Module  
Model CPS 15–50, unmetered Power Module  
shown with "ears" for 19" rack mounting.  
The ears are detachable for chassis mounting.

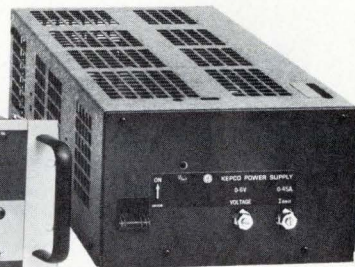

250–500W Module

**KEPCO** **CPS** is

**a no-compromise  
computer power supply!**



Write Dept. CL-14 for your copy of  
the new Kepco Power Supply Hand-  
book and Catalog.

**KEPCO**®

KEPCO, INC. • 131-38 SANFORD AVENUE • FLUSHING, N.Y. 11352 U.S.A.  
(212) 461-7000 • TWX #710-582-2631 • Cable: KEPCOPOWER NEWYORK

# CAN YOUR POWER SUPPLY RUN THE GAUNTLET?

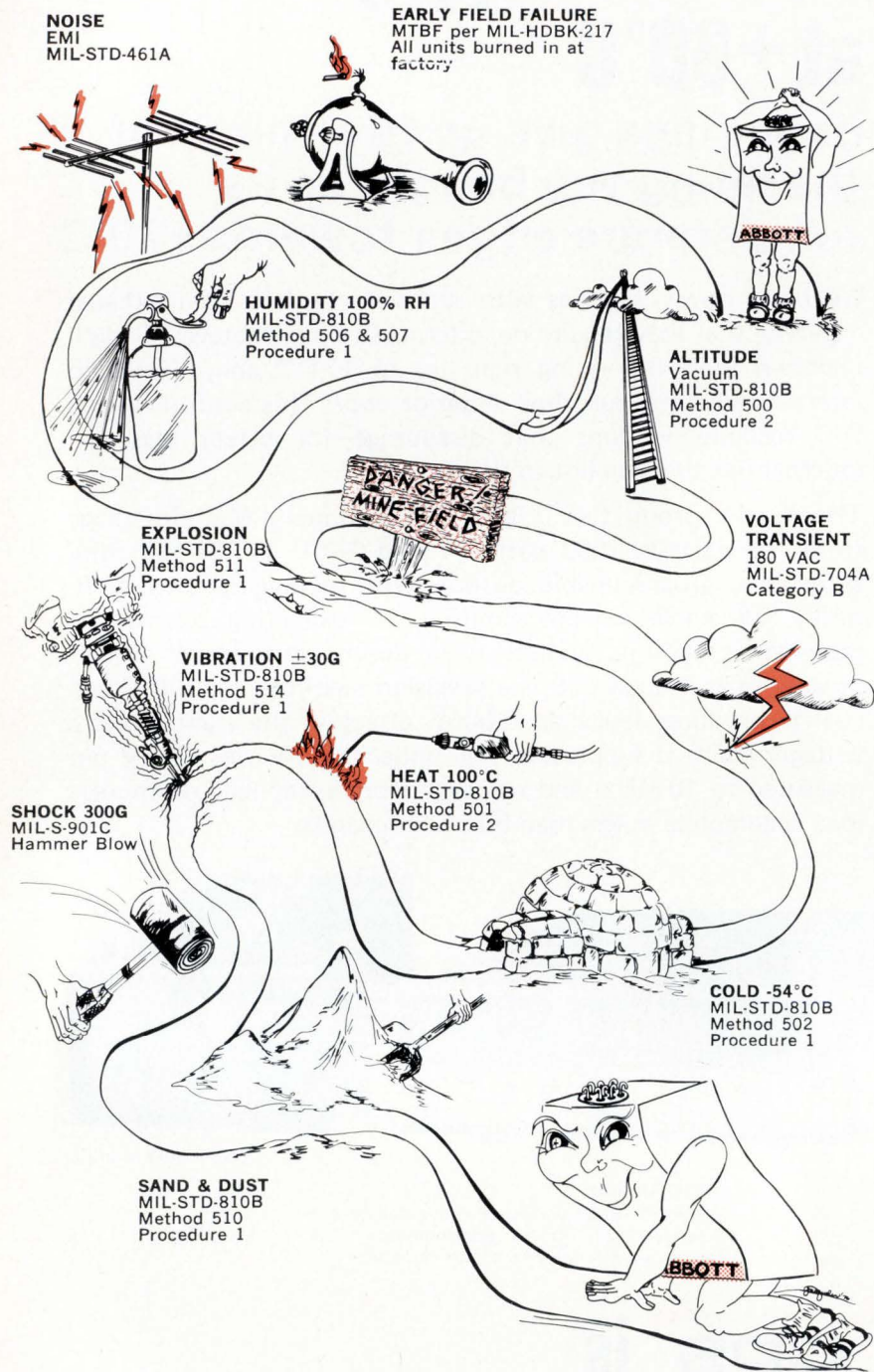

Abbott's hermetically sealed power supplies have run this gauntlet many times. Each and every unit is subjected to rigid quality control procedures and extensive testing at our factory to insure that it will pass the most important test — your gauntlet.

Please see pages 1836-1848 of your 1976-77 EEM (ELECTRON ENGINEERS MASTER Catalog) or pages 676-682 Volume 2 of your 1976-77 GOLD BOOK for information on Abbott Modules.

Send for our new 60 page catalog

**abbott transistor**  
LABORATORIES, INCORPORATED

**GENERAL OFFICES**  
5200 W. Jefferson Blvd.  
Los Angeles, CA. 90016  
(213) 936-8185  
Telex 69-1398

**EASTERN OFFICES**  
1224 Anderson Ave.  
Fort Lee, N.J. 07024  
(201) 224-6900  
Telex 13-5332

"See us at WESCON/76 SHOW in Los Angeles, Booth No. 1057"

6 Circle 6 on reader service card

## Readers' comments

### Distributors go optoelectronic

**To the Editor:** Siemens AG is definitely not the first to develop an optoelectronic distributor [*Electronics*, April 29, p. 30]. Allison Corp. in California has been marketing optoelectronic distributor-modification kits for several years.

V. L. Turner  
E.I. duPont deNemours & Co.  
Wilmington, Del.

■ This one of several letters we have received pointing out the availability of optoelectronic modification kits in the automotive aftermarket. The point of the article was that Siemens is developing a low-cost mass-produced system that could be installed as standard equipment.

### Gremlins mix instructions

**To the Editor:** Several gremlins were at work in my article, "Large hexadecimal display is legible from afar" [June 10, p. 129]. In forming hexadecimal "C," segment f (output B<sub>5</sub>) should be a 0, as well as LED 6 (output B<sub>3</sub>). Segment f (output B<sub>5</sub>) should be 0 in both "E" and "F."

A. J. Bryant  
Monelco Electronics Ltd.  
Winnipeg, Man., Canada

### Failure rate erred

**To the Editor:** In your article on the reliability of DEC's LSI-11 [July 8, p. 62], you indicate that failure rate is 0.006%. However, you also indicate that 20 machines out of 3,000 were found defective. Unless my fifth-grade arithmetic fails me, that's 0.006 or 0.6%, which is less exciting by two orders of magnitude.

Jim Warren  
Dr. Dobbs' Journal of Computer  
Calisthenics & Orthodontia  
People's Computer Co.  
Menlo Park, Calif.

### Correction

In the article on video games, [June 24, p. 89], the supplier of special systems to test General Instrument Co. game chips is Macrodata Corp. of Woodland Hills, Calif., rather than Macrodata Corp. of Irvine, Calif.



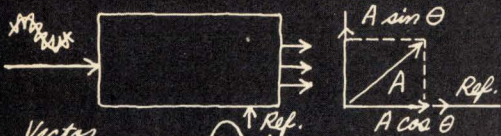

**Vector Voltmeter:**

Three outputs simultaneously available. Continuous 360° phase offset capabilities for phase nulling to 1°. 90° & 180° switches accurate to .1 degree.

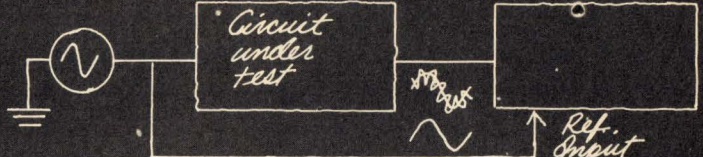

**Narrow Band AC Voltmeter:** Measure cross talk, power supply rejection, and other low level coupling phenomena. Automatically tracks signal frequency.

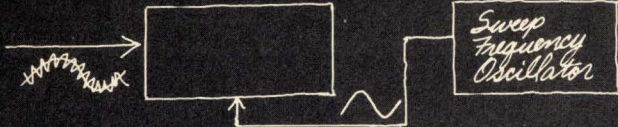

**Ultra Sensitive Spectrum Analyzer:** Tune manually with controls provided, or sweep by synchronizing to external sweep oscillator!



**Tracking Filter (measure frequency of noisy signal)** Signal tracking mode phase locks internal oscillator to noisy signal.

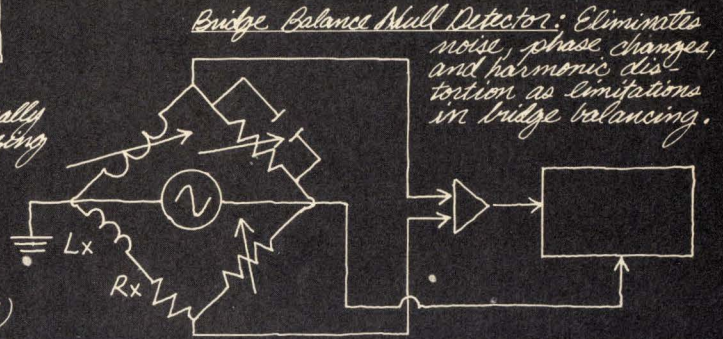

**Bridge Balance Null Detector:** Eliminates noise, phase changes, and harmonic distortion as limitations in bridge balancing.

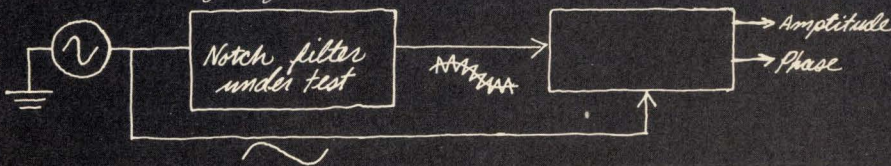

**Transfer Function Analyzer** Measure notch filter depth and phase characteristics.

# Measure noisy signals up to 200 kHz—like you've never measured them before.

A new test and measurement tool, the Dynatrac® 3 lock-in analyzer, measures amplitude, frequency, phase and narrow band noise at signal levels from picovolts to volts, frequencies from .1 Hz to 200 kHz, and selectable bandwidths from .001 Hz to 100 Hz. It easily detects signals that are 100 dB below an interfering signal—a dynamic range that is currently beyond the state of the art in digital technology.

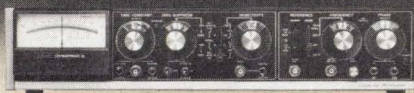

Because of its ability to measure signals in the presence of noise, there are many applications in which Dynatrac 3 picks up where the performance of vector voltmeters, phase meters, lock-in amplifiers, wave analyzers, transfer function analyzers,

bridge balance null detectors, and noise meters leave off.

With its phase option, Dynatrac 3 measures the phase of signals completely obscured by noise with an accuracy of ±1° and resolution and stability of .1°.

Dynatrac 3 delivers trouble-free performance with RFI protection. And a floating guarded front end eliminates ground loops.

The sketches above illustrate just some of the many applications for this unique new test and measurement tool.

To get the complete Dynatrac 3 story (and to tell us about your signal measurement problems), contact Ithaco, Box 818-E, Ithaca, New York 14850. Or telephone (607) 272-7640 or TWX 510-255-9307.

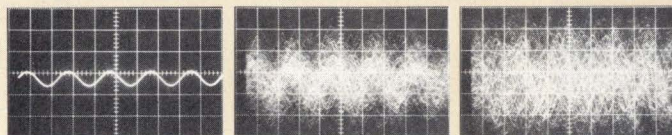

# Want to make waves?

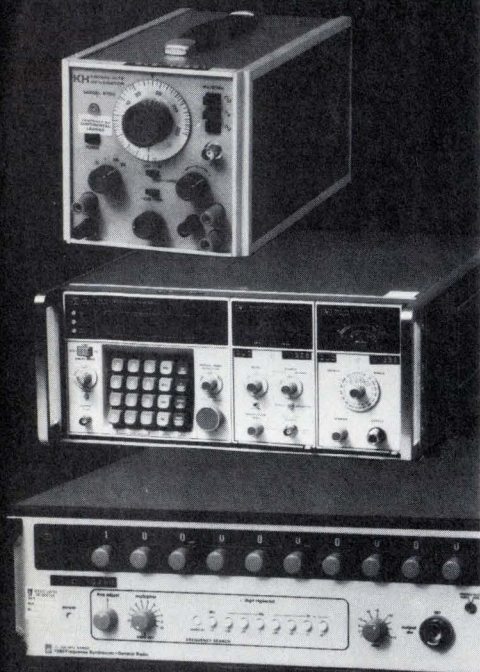

Call the "Instrument Professionals". They can tell you which generator, oscillator or synthesizer best fits your needs. They'll have it on your dock tomorrow—guaranteed to make all the waves you need. Renting the right gear will keep your head above water!

Write or call for data on our other specialties: Instrument Leasing • Computer Peripherals • Equipment Sales • Instrument Service.

Circle 8 on reader service card

Call  Get our FREE Catalog

# Continental Rentals

Div. Continental Leasing Co., Inc.  
175 Middlesex Turnpike, Bedford,  
MA, 01730 (617) 275-0850

Metuchen, NJ (201) 549-8500;

Gaithersburg, MD (301) 948-4310; TX  
(214) 357-1779; Elk Grove, IL (312)

439-4700; Costa Mesa, CA (714)

540-6566; Santa Clara, CA (408)

735-8300; Los Angeles, CA (213) 477-7521

## News update

■ The first leap of Reticon Corp. into the consumer-oriented market has made quite a splash, says John Rado, president of the Sunnyvale, Calif., company. Known for its image-sensing arrays and analog processing devices, Reticon about a year ago came out with a 1,024-bit n-MOS bucket-brigade analog delay device priced at less than 1 cent per bit [*Electronics*, Aug. 21, 1975, p. 25]. The part, called SAD (serial analog delay) 1024, has been in volume production for nine months, says Rado. "SAD is very happy," he adds, noting that customers include organ manufacturers and companies involved in reverberation, speech compression, and music. For example, one application of SAD 1024 is in rock music—it makes one guitar sound like five. Now packaged in plastic, rather than the prototype ceramic, the device sells for less than \$4 in quantities of 100,000 and up. Its dynamic range exceeds 75 decibels, bandwidth tops 100 kilohertz, sampling frequency is 1 to 2 megahertz, and harmonic distortion is less than 1%.

■ After three attempts to write a safety standard for test and measurement instruments [*Electronics*, Feb. 19, p. 8], Underwriters' Laboratories Inc. is going back to its well-worn drawing board once again. While few substantive changes are expected in the fourth version, UL has agreed with some industry comments that "safety should be an international concern and not just a national concern," says Don Mader, engineering group leader in the electrical department at UL's Melville, N.Y., office.

It's redrafting standard UL 1244 to conform where possible with the wording, margins, indexing, indenting, and type of printing used by the International Electrotechnical Commission in its document, IEC 348. A new schedule calls for members of a coordinating committee, consisting of representatives of industry and UL, to rewrite UL 1244. A final draft is due to the UL for industry comment in November.

# For bonding metal- to-metal- to-glass- to-glass-to- plastics- to-plastics- to-rubber-to- rubber-to- metal-to-etc- to-etc.

One drop goes a long way in fastening almost anything to almost anything.

Eastman 910<sup>®</sup> adhesive bonds fast, too. Almost instantaneously. With only contact pressure.

Tensile strength? Up to 5000 psi at room temperature.

For further data and technical literature, write: Eastman Chemical Products, Inc., Kingsport, Tennessee 37662.



Circle 10 on reader service card



## Watch module producers choose Du Pont thick film materials systems.

And they've got the best of reasons. They get a complete materials system from one dependable source which can help keep materials costs low and production yields high.

For instance, many producers choose Du Pont Platinum/Silver 9770 Conductor, along with the compatible resistors and dielectrics that make up a complete system.

9770 offers a unique combination of advantages: low cost, excellent wire bonding, high conductivity, and a rheology

suitable for fine-line printing and through-hole or edge-around connections.

The compatible BIROX® 9600-Series Resistors give watch module makers their most-often-required 100K to 10 megohm/square resistivities. The excellent reproducibility of BIROX and its ease of processing help increase substrate yields.

For crossovers, our Low-K Dielectric 9429 can be co-fired or fired separately. Where contrast is desired, watch module producers prefer 9865, which gives the same compatibility as

9429 plus an intense matte black surface.

Choose the Du Pont system that best fits your needs. You get maximum flexibility in cost/performance tradeoffs with our wide selection of materials. Whether you make watch modules or any other thick film hybrid circuit or passive network, Du Pont has a cost-effective system of materials for your application.

Call—toll free—800-441-9475. Or write: Du Pont Company, Electronic Materials Division, Room 25008, Wilmington, DE 19898.

## Electronic Materials Division



**Electronics**

Circle 9 on reader service card

# The Adventures of Digital Don.

Once there was an engineer named Digital Don who was into gates and flops and stuff like that. Don was... well... he was consistent.

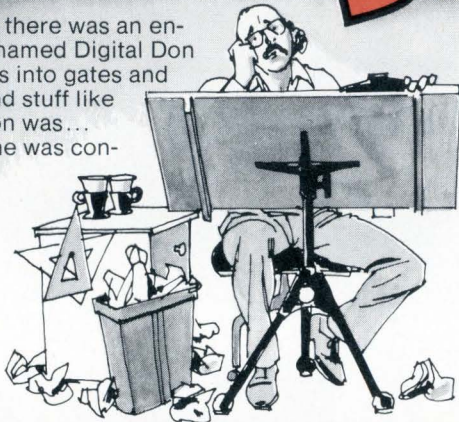

He wasn't like the guys down the hall who were into micro-programming — the ones with lots of technicians, three-piece suits, fancy new equipment and slinky secretaries.



GOSH, YOU'RE NEAT.

WAIT'LL YOU SEE MY PIPELINE REGISTER.

SIGH.

Don didn't know much about micro-programming. There was never an easy way to get into it. And besides, he always did things the way he always did them, so why should he change now?

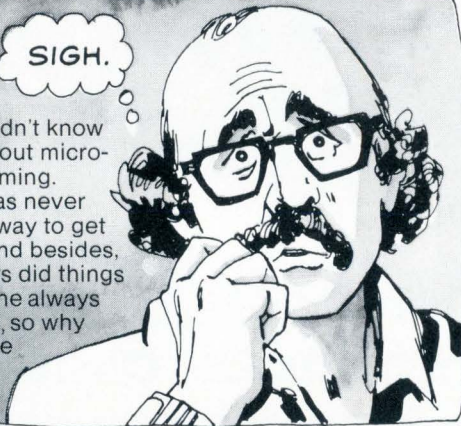

I'M REALLY WORRIED ABOUT HIM, GEORGE.

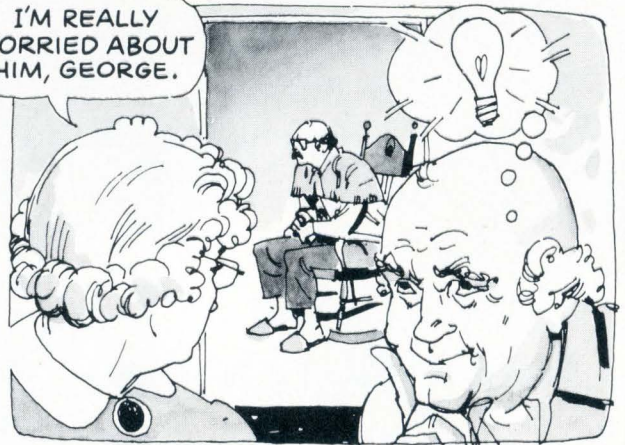

The Advanced Micro Devices' Learning and Evaluation Kit can teach Don how to configure a microprogrammed architecture using the industry standard Am2900 family. He'll be able to write and execute micro-instructions that will completely control an Am2901 microprocessor slice and Am2909 microprogram sequencer — just like a high-performance CPU.

GOLLY! FOR ME?!?!





### The Am2900K1 Learning and Evaluation Kit.

It's terrific. For only \$289.00 you can master the basic theory and application of microprogramming. Here's what you get:

A read/write memory storing up to 16 microinstructions driving a pipeline register. From the pipeline register, the microinstructions control: an Am2901; circuits for logical and arithmetic shift and rotation; and the Am2909 sequencer that selects the next microinstruction address. Sixteen sequence control functions are built in, including conditional branch, loop, jump to subroutine and return. Built-in display logic

makes nearly every point in the system available at an LED display.

The Kit includes forty IC's, LED's, switches, resistors, decoupling capacitors, PC board and a really comprehensive manual covering assembly instructions, theory and experiments. The only thing you need to add is a 5-volt power supply.

Throw away your gates and flops. Get the Advanced Micro Devices Learning and Evaluation Kit from your AMD distributor. And become one of the really popular guys.



# Advanced Microprocessors



Advanced Micro Devices • 901 Thompson Place, Sunnyvale, California 94086 • Telephone (408) 732-2400 •  
Distributed nationally by Hamilton/Avnet, Cramer and Schweber Electronics.

# Editorial

---

## Inaction: the hidden 'dumping' danger

Faced with a threat to their markets, U.S. consumer-electronics companies have every right to expect a speedy hearing of their complaints by the U.S. Government. Regardless of whether Japanese TV-set makers are actually "dumping" their goods below cost in the U.S., American manufacturers should not have to fight Washington bureaucracy, battle red tape, or wait an unreasonable length of time just to be heard. But it seems they have to, and by the time the Federal Government acts—if it ever does—it may be too late for the protection that the trade laws were designed to provide.

Take just a couple of current cases. Nearly two years ago, Zenith filed an antitrust suit against 31 Japanese TV manufacturers. To date, that action has not even reached trial.

Last month, GTE Sylvania and its subsidiary, Philco, filed a complaint with the International

Trade Commission that 13 Japanese companies have conspired since 1966 to monopolize the U.S. color-TV market. But the Treasury Department, claiming exclusive jurisdiction over dumping charges, says the ITC can't handle the complaint. The result: no hearing on the issues—let alone action—until the Government decides who should do the hearing. The Treasury department, by the way, ruled that the Japanese were dumping TV sets in 1971. That ruling, however, led to no significant relief for domestic manufacturers.

It's time for the Treasury Department, since it claims exclusive jurisdiction, to back up its claims with actions. A decision, whether it finds merit in the complaints or not, would be a step toward clarifying the situation. Further, if the complaints are borne out, it should take strong, decisive steps to close the gates on imports that are damaging domestic production capacity.

## Optical fibers turn the corner

Fiber-optics communications, it is becoming increasingly clear, has passed that crucial threshold that divides a promising technology from a practical one. The necessary materials and components—from low-loss glass fibers to field-installable connectors—are now available, and available from a variety of sources. A number of applications, in the United States, Europe, and Japan, have by now removed any doubts about the feasibility of transmitting large amounts of data down the narrow glass waveguides.

To be sure, one of the remaining obstacles in the way of fiber-optic communications is cost. Yet recent strides and current development work are rapidly bringing per-meter costs down within competing distance of coaxial cable, and in all probability another few years will see fibers, on a downward price curve, competing on a per-meter basis with copper cables, which will probably continue

their upward price trend.

What's left, then, before optical fibers are assured a fundamental place in communications is the establishment of methods for unified, coordinated accumulation and transfer of optical-fiber knowledge. Probably the surest sign that optical-fiber communications is here to stay is upsurge in work on promulgating standards, on arranging for interchanges of technical papers and documents, and on worrying about training tomorrow's engineers in the basics of fiber optics.

Yet these projects are just beginning and, in the headlong rush to bring products to the marketplace, are sure to be given fairly low priorities. It would certainly be a refreshing change, though, if standards setting and the updating of education came hand-in-hand with the technological progress rather than years later.

# SERIES 40's Frequency Marker ends frequency-chasing and control-twiddling.

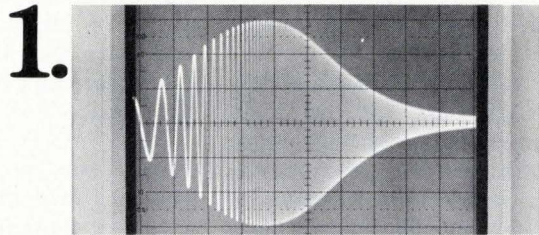

**Sweep the Unit Under Test.** Here, for example, is the output of a filter being swept from 600 Hz to 60 KHz on channel 1 of the scope.

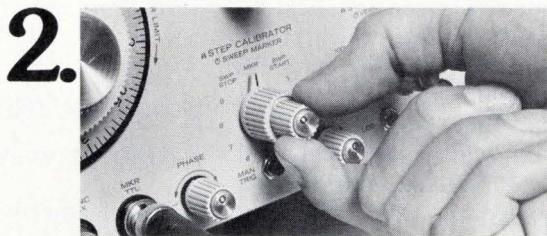

**Select Sweep Marker.** On Interstate's new F47 function generator, you select "Marker" and set its TTL output on the scope's channel 2.

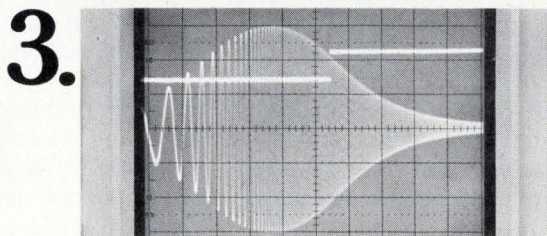

**Adjust the vernier.** Then you fine-tune the marker vernier to pinpoint the TTL step at the exact position on the waveform for which you want to know the frequency. On the scope shown, the marker is positioned at the 70% roll-off point... the -3 db level.

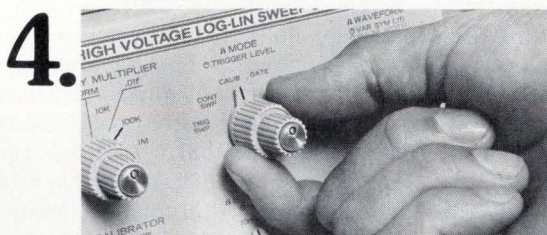

**Select Calibrate Mode.** Next, you switch from the Continuous Sweep Mode to the Calibrate Mode.



**Get the exact frequency.** A counter at the F47's output will then display the precise frequency at which the filter's -3 db point occurs.

## SERIES 40 Function Generators - New from INTERSTATE



SERIES 40 is the only function generator line with marker, 10-step frequency calibrator, state-of-the-art high output voltage to 40 v p-p open circuit, and Interstate's exclusive direct-reading sweep width control. The best function generators money can buy from \$475 to \$695. Write for the new SERIES 40

**INTERSTATE**  
ELECTRONICS CORPORATION

Subsidiary of A-T-O Inc.

catalog for complete specifications and prices.

P.O. Box 3117, Anaheim, California 92803 • (714) 549-8282 • TWX U.S.A. 910-591-1197 • TELEX 655443 & 655419



**RCL**  
HAS THEM ALL!

FROM A "PIP"  
OF A "DIP"  
TO  
INDUSTRY'S  
LARGEST  
SELECTION  
OF  
**MINIATURE  
ROTARY  
SWITCHES**

2-24 POSITIONS  
1-24 DECKS

*Others Promise—  
RCL Delivers!*

Call Our Hotline For Name Of  
Your Local Representative Or  
Stocking Distributor.

(201) 374-3311

**AMF**

**RCL Electronics**

General Sales Office:  
700 So. 21st Street  
Irvington, N. J. 07111

## People

Art Fury counts on FETs  
with power at Siliconix

If custom design is successfully nudged to the side by high-volume standard integrated circuits at Siliconix Inc. of Santa Clara, Calif., 39-year-old Art Fury will be doing much of the nudging. Manager since last month of the new central marketing group, Fury will concentrate on applying Siliconix' vertical-metal-oxide-semiconductor field-effect transistor process, which promises considerable inroads into the bipolar power-transistor market [*Electronics*, June 24, p. 98].

Siliconix, which last year had sales of \$30 million, has been a supplier of conventional field-effect transistors, analog switches, and linear integrated circuits. About a year ago, president Richard Lee began moving the company into large-scale digital integrated circuits, digital stopwatches, and digital voltmeters. But the new FET process probably holds center stage.

"Until recently, all FET structures were limited to low-current applications, leaving the multimillion-dollar discrete power transistors that were developed over the past 20 years to be dominated by bipolar technology," Fury says. "We intend to change that."

**Early standards.** If anyone can bring Siliconix' vertical-MOS products into a position of dominance, it's Fury, who came to Siliconix after a year as marketing director for digital ICs at Fairchild Camera and Instrument Corp. Before that, as an advanced-product planner at Signetics Inc., he stage-managed the introduction of the phase-locked loop and the NE-555 timer, both now industry standards.

Later, at National Semiconductor Corp., he was responsible for the introduction of the LM324 and LM339 quad operational amplifiers and the LX 5600 solid-state temperature transducer, which became industry standards, as well.

"The same thing can be done with vertical MOS," Fury asserts. "It makes multi-ampere, high-voltage,

high-power MOSFET devices possible, with electrical and speed advantages over comparably rated bipolar devices." An enormous market potential exists, not only in the replacement of bipolar transistors, he continues, but also in new applications that can't be handled by available devices.

"If we do everything right," says Fury, "MOS power FETs have the potential of doubling Siliconix sales in a very short time. I plan to make sure we do everything right."

Solid-state relays: Theta-J's  
Rodriguez wants low cost

A lot of adjectives—like confident, knowledgeable and determined—describe Edward T. Rodriguez, the new chairman and technical director of Theta-J Relays Inc. He's out to shake up the staid old relay business by using the latest circuit and assembly techniques common in the semiconductor industry in order to slash solid-state-relay prices (see p. 120).

Rodriguez is determined that Theta-J eventually will be the first company to sell solid-state relays at close to \$1 instead of today's usual \$15. And he's thoroughly convinced that his semiconductor background—11 years in power semicon-

**Downward.** Ed Rodriguez wants to be first with solid-state relays that sell for about \$1.

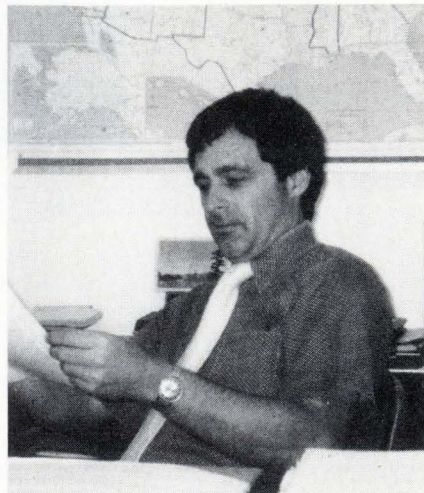



# Why draw it when you can photograph it?

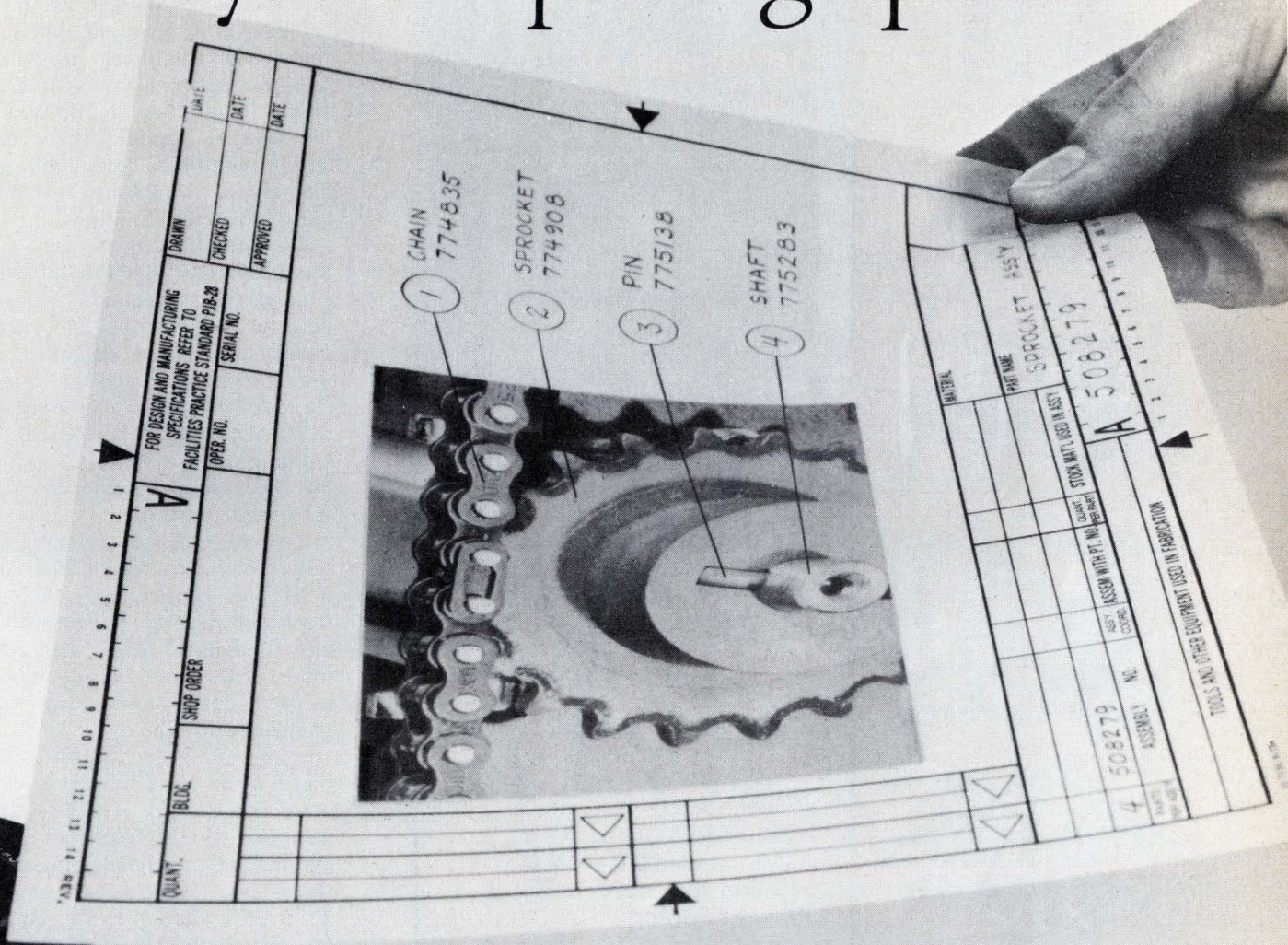

A picture not only saves a lot of words, it saves a lot of drafting time. And the end result is generally a lot easier to understand. So get the best of both worlds by combining photos and line work in your maintenance and instruction manuals, assembly and installation drawings, and other complicated designs.

For more information on how this and other reprographic shortcuts can save you money, write: Eastman Kodak Company, Graphics Markets Division, Dept. R6815, Rochester, New York 14650.

## Kodagraph films and papers

Versatility in reprographics



0.01  
630-

WIMA  
FKP 1

0.033  
630-

WIMA  
FKP 1

0.015  
1000-

WIMA  
FKP 1

0.056  
1000-

WIMA  
FKP 1

0.15  
1000-

WIMA  
FKP 1



# WIMA FKP 1

Self healing  
polypropylene  
capacitors  
with the  
lowest losses  
for high  
current duties

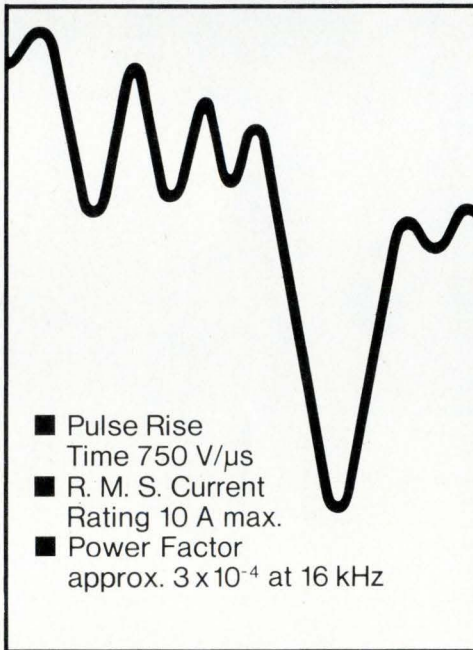

The unique capacitor designed for thyristor deflection circuits in colour television sets. Proven in leading TV models and in solid state equipment.

Write for our new catalogue!

## WILHELM WESTERMANN

Spezialvertrieb  
elektronischer Bauelemente  
D-68 Mannheim · Fed. Rep. of Germany  
Augusta-Anlage 56 · P.O. Box 2345  
Tel.: (06 21) 40 80 12

## People

ductors—will bring this about.

Theta-J, in Reading, Mass., was founded only last year by Allan Q. Mowatt. Rodriguez, 39, came to the company only two months ago from his post as product manager for silicon controlled rectifiers, triacs, and power transistors at Unitrode Corp., Watertown, Mass.

**Good base.** "I'm the only guy in this business with a first-hand semiconductor background," Rodriguez declares. "I was applying semiconductor-circuit and assembly techniques eight years ago that others in the relay business are reading about in books now." He's also been working on solid-state relays on his own because of his interest in them for several years.

"We have to stop thinking about these devices as relays," he continues. "Theta-J is really in the power-transistor and triac business because our solid-state relays are nothing more, really, than a triac, an SCR, or a power transistor—along with a photocell—in a box."

Rodriguez is looking for ways to make some of the circuit devices serve as the boxes. And he's already done this with a 10-ampere relay by making the triac housing the base of the relay package [*Electronics*, July 22, p. 35]. Moreover, the relay sells for less than \$3 in quantities of 10,000.

**Proprietary developments.** But Rodriguez' emphasis on price reduction does not mean that Theta-J merely has a bargain-basement approach to the products it designs and builds. There are also proprietary and patentable photocell and zero-switching-circuit techniques in Theta-J's product line. It's just that he feels "price will be the big hurdle to overcome, and while that philosophy demeans your technology, you have to accept it and assemble these products in just one minute, instead of 15 minutes."

At Theta-J, he foresees that pick-up in production speed being reached "in the near future" so that solid-state units can be priced at \$1.25 in quantity. And that is sure to draw his competitors' attention.

## TO-5 RELAY UPDATE

# The world's smallest RF relay

Inherently low inter-contact capacitance and contact circuit losses have established the Teledyne TO-5 relay as an excellent subminiature RF switch for frequencies up through UHF. Typical RF performance: 45db isolation and 0.1db insertion loss at 100MHz.

Added to this, our TO-5 relay requires very low coil power compared to other miniature relays — as much as 75% less than a half crystal can relay.

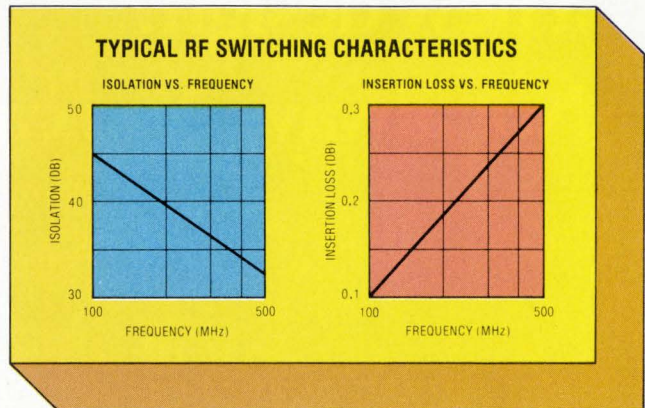

For hand held radio transceivers, for example, where battery power drain as well as good RF performance are key factors, Teledyne's TO-5 relay is the logical choice for T-R switching.

Our complete line of TO-5 relays includes military and commercial/industrial types, with virtually all military versions qualified to established reliability MIL specs. For complete data, contact Teledyne Relays — the people who pioneered the TO-5 relay.

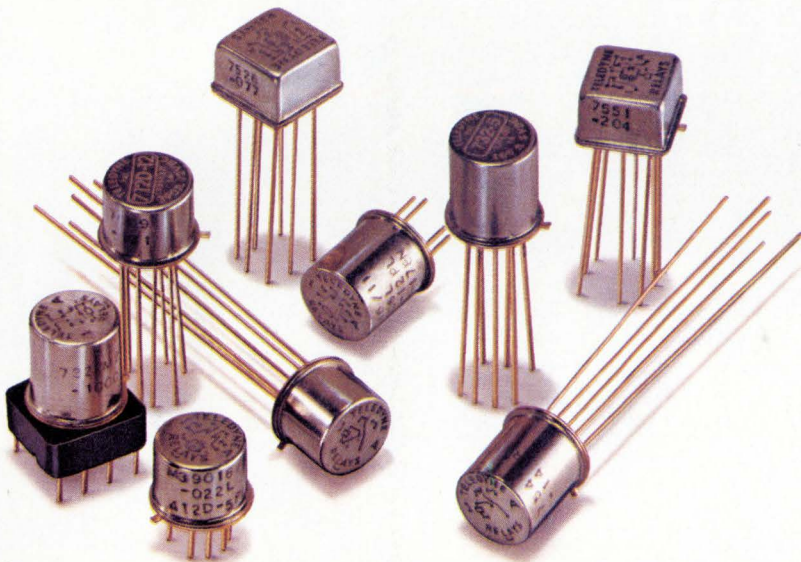

- **Hybrid "T" Series**  
SPDT & DPDT types with internal transistor driver and suppression diode. Military and commercial/industrial versions.
- **"D" and "DD" Series**  
With internal suppression and steering diodes. Military and commercial/industrial versions.
- **Maglatch Series**  
SPDT, DPDT, and 4PST magnetic latching types. Military and commercial/industrial versions.
- **Centigrad® Series**  
World's smallest relay—only .225" (5.72mm) high x .370" (9.40mm) square. DPDT, with optional internal suppression and steering diodes.
- **Hi-Rel Series**  
Screened versions for space flight applications (NASA qualified)
- **High Environment Series**  
Hi-temperature, Hi-shock, and Hi-vibration types

 **TELEDYNE RELAYS**

3155 West El Segundo Boulevard, Hawthorne, California 90250  
Telephone (213) 973-4545

**Must you always obtain new application tooling when you develop a new design?**

**Not always. You can use AMP Multimate.**



You asked for a way to produce new I/O cable or internal harness designs without always having to obtain new connector application tooling.

AMP answers with the Multimate concept.

For example.

A choice of three, size 16 contacts. A screw machine contact, and 1 or 2-piece precision formed contacts. All interchangeable and intermateable plus AMP Subminiature Coaxial contacts fit in the same cavities when needed.

Then specify AMP Connector housings from many proven styles and sizes.

The rugged, economical Circular Plastic Connector, or those versatile M Series connectors widely used for commercial and military applications; or the AMP MI Connectors, designed to international standards. Additionally there is a cast shell rack and panel range as well as metal-shelled modular connectors.

If you have AMP application tooling for the Multimate contacts, you can produce these connector assemblies. And that can save inventory and allows for larger piece part volume purchases. Further savings can be made in the field because fewer service tools are needed.

Here at AMP, answering your problems is our business.

So when you work with Multimate, you can expect the kind of service and backup for which AMP is famous.

We have district sales offices around the country; they are there for one purpose only. To serve you.

With Multimate, you not only get real contact-connector flexibility, you have AMP behind your design innovations.

For information on Multimate, write or call AMP Incorporated, Harrisburg, PA 17105. (717) 564-0100.

# AMP

INCORPORATED

Circle 19 on reader service card

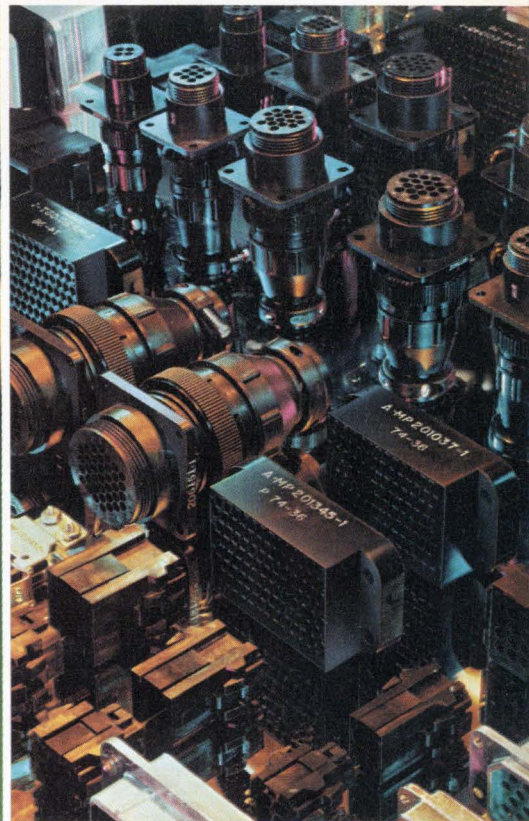
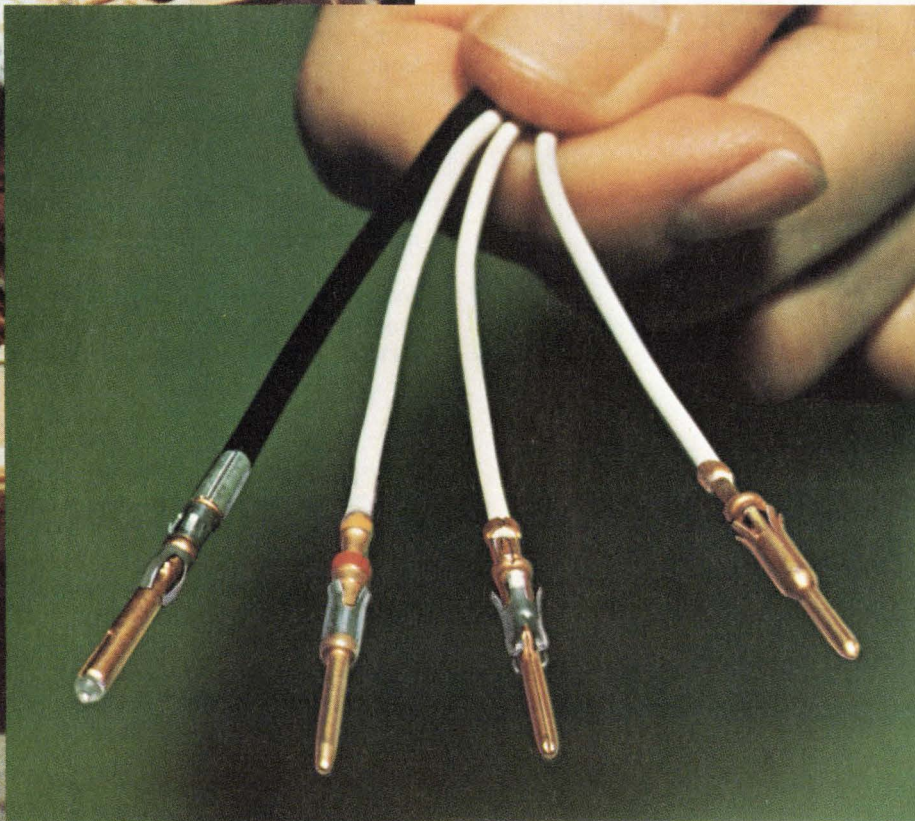

# asking about SUBMINIATURE LAMPS?

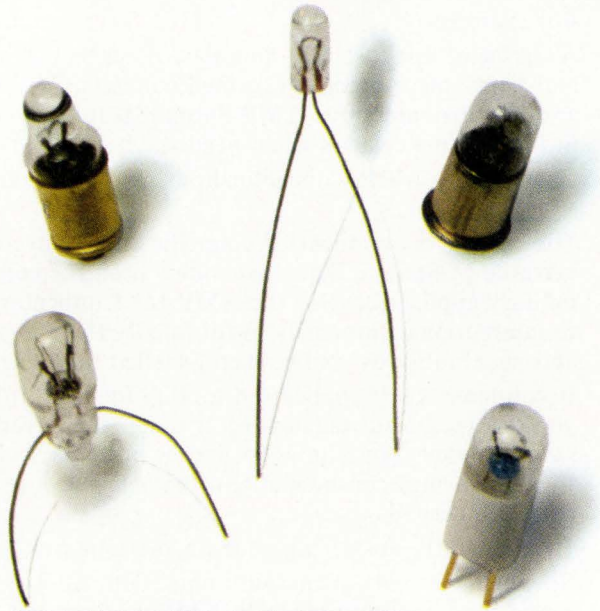

## CHICAGO MINIATURE HAS THE ANSWER!



Chicago Miniature has the answer for every subminiature application. All base configurations or wire terminal . . . all colors . . . standard products and specials . . . whatever you need with high quality at competitive prices. There's off-the-shelf delivery on most items from your distributor. For more information, or expert design help, contact Chicago Miniature Lamp Works, 4433 N. Ravenswood Avenue, Chicago, Illinois 60640. Phone (312) 784-1020.

### CHICAGO MINIATURE LAMP WORKS

GENERAL INSTRUMENT CORPORATION



## Meetings

**20th Annual SPIE Technical Symposium and Instrument Display**, Society of Photo-Optical Instrumentation Engineers, Town and Country Hotel, San Diego, Aug. 23-27.

**Parallel Processing International Conference**, IEEE and Wayne State University, Walden Woods Resort and Conference Center, Walden Woods, Mich., Aug. 24-27.

**Seventh International Symposium on Acoustical Imaging and Holography**, IEEE *et al.*, Howard Johnson's Hotel at O'Hare Airport, Schiller Park, Ill., Aug. 30-Sept. 1.

**1976 International Conference on Solid State Devices**, Japan Society of Applied Physics, Tokyo, Sept. 1-3.

**Comcon 76 Fall**, IEEE, Mayflower Hotel, Washington, D.C., Sept. 7-10.

**Communication '76**, listed in last issue's Meetings column as scheduled for Sept. 7-10, in Essen, West Germany, has been postponed. No new date has been set.

**International Symposium on Technology for Selective Dissemination of Information**, ACM *et al.*, Palazzo dei Congressi, Republic of San Marino, Sept. 8-10.

**1976 International Machine Tool Show**, National Machine Builder's Association (McLean, Va.), International Amphitheatre and McCormick Place, Chicago, Sept. 8-17.

**Intersociety Energy Conversion Engineering Conference**, IEEE *et al.*, Sahara Tahoe Hotel, Stateline, Nev., Sept. 12-17.

**25th Annual Conference of Standards Engineers Society**, SES, Chalfonte-Haddon Hall Hotel, Atlantic City, N.J., Sept. 13-15.

**Oceans '76**, Marine Technology Society and IEEE, Sheraton-Park Hotel, Washington, D.C., Sept. 13-15.

**Electro Optics/Laser '76 Conference and Exposition**, Industrial & Scien-

# HP's new thermal printer just keeps purring along.

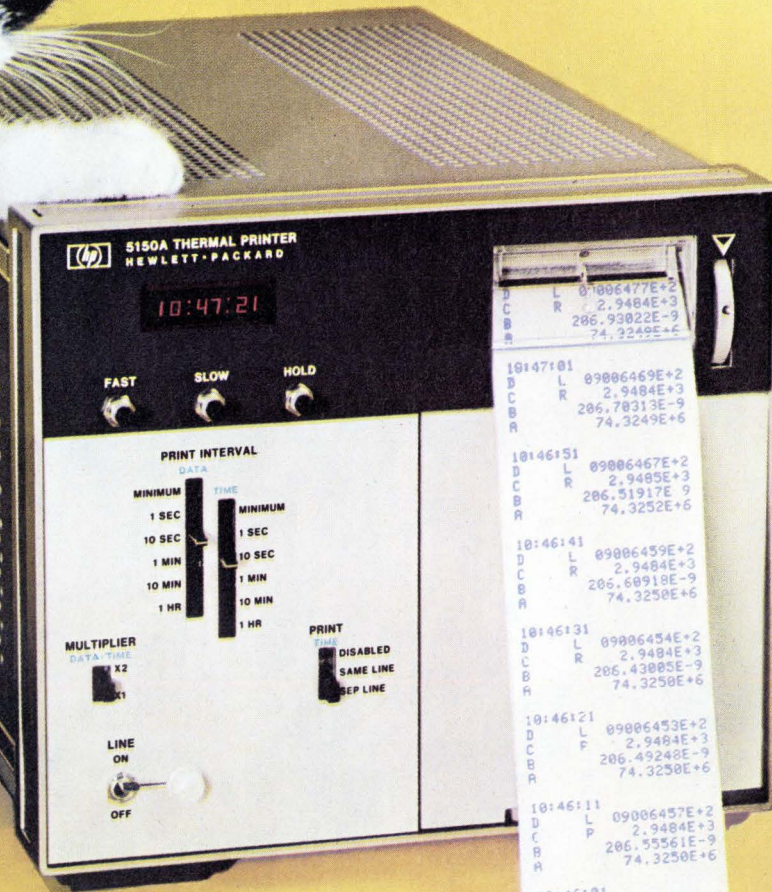

Say goodbye to the clank and rattle of mechanical printers and say hello to quiet, reliable operation. With its thermal printing technique, the new HP 5150A Thermal Printer needs only two moving parts — those that transport the tape.

That's just a beginning. Built-in flexibility and plug-in options mean that, at last, there is a printer that you can custom-tailor to your data printout needs without delay or compromise.

**Alphanumeric printout.** A full 64-character upper case ASCII printing set, with figures and symbols that read and reproduce clearly. Print speed is three lines per second.

**ASCII Interface option.** Interfaces to most ASCII coded sources or HP Interface Bus. Full 64-character, 20-column printout.

**BCD Interface option.** Interfaces with BCD  $\pm$  8421 sources. Prints standard 16-character set, but can draw on the full 64-character complement of the 5150A. Ten or 20 columns.

**Scanner option.** The 5150A can function as a system controller for up to 13 instruments on the HP Interface Bus, providing automatic data-acquisition capability.

**Clock option.** With it, an entirely new order of convenience, flexibility and control becomes possible. Simple, front-panel controls let you record the time of day and select the time interval between samples.

**Special BCD printouts.** Special formats or re-interpretation of BCD inputs can be provided at minimum cost.

**The price is right.** Only \$875\* for the 5150A mainframe. Plug-in options range from \$125\* to 350\*. At the price, no other printer matches its flexibility, quietness and reliability. Write, or call your nearby HP field engineer, for complete technical specifications or a demonstration.

\*Domestic USA prices only.

HP 5150A THERMAL PRINTER  
HEWLETT-PACKARD

10:47:21

FAST SLOW HOLD

PRINT INTERVAL

MINIMUM DATA TIME MINIMUM  
1 SEC 1 SEC  
10 SEC 10 SEC  
1 MIN 1 MIN  
1 HR 10 MIN  
1 HR

MULTIPLIER  
DATA TIME  
X2  
X1

PRINT  
TIME  
DISABLED  
SAME LINE  
SEP LINE

LINE  
ON  
OFF

10:47:01  
D L 09006477E+2  
C R 2.9484E+3  
B 206.93822E-9  
A 74.3249E+6

10:46:51  
D L 09006469E+2  
C R 2.9484E+3  
B 206.78313E-9  
A 74.3249E+6

10:46:41  
D L 09006467E+2  
C R 2.9485E+3  
B 206.51917E-9  
A 74.3252E+6

10:46:31  
D L 09006459E+2  
C R 2.9484E+3  
B 206.60918E-9  
A 74.3250E+6

10:46:21  
D L 09006454E+2  
C R 2.9484E+3  
B 206.4388E-9  
A 74.3250E+6

10:46:11  
D L 09006457E+2  
C R 2.9484E+3  
B 206.55561E-9  
A 74.3250E+6

10:46:01  
D L 09006452E+2  
C R 2.9484E+3  
B 206.62194E-9  
A 74.3250E+6

10:45:51  
D L 09006457E+2  
C R 2.9484E+3  
B 206.64314E-9  
A 74.3251E+6

10:45:41  
D L 09006452E+2  
C R 2.9485E+3  
B 206.56900E-9  
A 74.3249E+6

10:43:11  
D L 09006473E+2  
C R 2.9483E+3  
B 206.73763E-9  
A 74.3252E+6

10:43:01  
D L 09006476E+2  
C R 2.9484E+3  
B 206.63879E-9  
A 74.3252E+6

10:42:51  
D L 09006474E+2  
C R 2.9483E+3  
B 206.46813E-9  
A 74.3252E+6

HEWLETT  PACKARD

Sales and service from 172 offices in 65 countries.  
1501 Page Mill Road, Palo Alto, California 94304

Circle 21 on reader service card

**Alabama**  
INTEREP ASSOCIATES  
205/881-3677

**Arizona**  
SUMMIT SALES  
602/994-4587

**Arkansas**  
SIEMENS CORPORATION  
817/261-6543

**California-**  
**Northern & East Bay**  
QUADREP INC.  
408/733-7300

**California-**  
**Southern (L. A.)**  
VARIGON ASSOCIATES  
213/679-0621

**California-**  
**Southern (San Diego)**  
S. R. ELECTRONIC  
714/565-8411

**Colorado**  
OMEGA, LTD.  
303/758-1508

**Connecticut**  
ANCHOR  
ENGINEERING CORP.  
203/658-6261

**Connecticut-**  
**(Fairfield County)**  
ERA, INC.  
516/822-9890

**Kansas**  
DY-TRONIX, INC.  
816/737-1100

**Kentucky**  
DOLFUSS-ROOT & CO.  
513/433-6776

**Louisiana**  
SIEMENS CORPORATION  
817/261-6543

**Maine**  
ANCHOR ENGINEERING CORP.  
617/964-6205  
KCA COMPONENTS INC.  
617/861-9024

**Maryland**  
J. A. MAGUIRE & CO., INC.  
301/377-0223

**Massachusetts**  
ANCHOR ENGINEERING CORP.  
617/694-6205  
KCA COMPONENTS, INC.  
617/861-9024

**Michigan**  
CMP INC.  
313/477-7700

**Minnesota**  
CAHILL ASSOCIATES, INC.  
612/646-7217

**Mississippi**  
INTEREP ASSOCIATES  
205/881-3677

**New Hampshire**  
ANCHOR ENGINEERING CORP.  
617/964-6205  
KCA COMPONENTS, INC.  
617/861-9024

**New Jersey-Northern**  
ERA, INC.  
516/822-9890

**New Jersey-Southern**  
J. A. MAGUIRE & CO., INC.  
609/665-5136

**New Jersey-Southern**  
THOMAS ASSOCIATES, INC.  
609/854-3011

**New Mexico**  
A. Q. ELECTRONICS  
505/255-8701

**New York-Metropolitan**  
ERA, INC.  
516/822-9890

**New York-Upstate**  
ELECTRA SALES CORP.  
315/455-5783  
ELECTRA SALES (Rochester)  
716/436-4030/4037

**North Carolina**  
J. A. MAGUIRE & CO., INC.  
919/725-7777

**Pennsylvania-Eastern**  
THOMAS ASSOCIATES  
609/854-3011  
J. A. MAGUIRE & CO., INC.  
609/665-5136

**Pennsylvania-Western**  
DOLFUSS-ROOT & CO.  
412/561-4125

**Rhode Island**  
KCA COMPONENTS, INC.  
617/861-9024  
ANCHOR ENGINEERING CORP.  
617/964-6205

**South Carolina**  
J. A. MAGUIRE & CO., INC.  
919/723-5980

**South Dakota**  
CAHILL ASSOCIATES  
612/646-7217

**Tennessee**  
INTEREP ASSOCIATES, INC.  
205/881-3677

**Tennessee (East)**  
J. A. MAGUIRE & CO., INC.  
919/723-5980

**Texas (except El Paso County)**  
SIEMENS  
817/261-6543

**Texas (El Paso County only)**  
A. Q. ELECTRONICS  
915/545-2363

**Connecticut-**  
**(except Fairfield County)**  
KCA COMPONENTS  
617/861-9024

**Delaware**  
THOMAS ASSOCIATES, INC.  
609/854-3011

**Delaware**  
J. A. MAGUIRE & CO., INC.  
301/377-0223

**District of Columbia**  
J. A. MAGUIRE & CO., INC.  
301/377-0223

**Florida**  
PERROTT ASSOCIATES INC.  
305/275-1132  
PERROTT ASSOCIATES INC.  
305/792-2211  
PERROTT ASSOCIATES INC.  
813/585-3327

**Georgia**  
INTEREP ASSOCIATES  
404/394-7756

**Idaho**  
OMEGA, LTD.  
801/266-9617

**Illinois-Southern**  
DY-TRONIX, INC.  
314/731-5799

**Illinois-Northern**  
METCOM ASSOCIATES CORP.  
312/696-1490

**Indiana**  
ELECTRA REPS, INC.  
317/255-4147

**Iowa**  
GASSNER & CLARK CO.  
319/393-5763

**Missouri-Eastern**  
DY-TRONIX, INC.  
314/731-5799

**Missouri-Western**  
DY-TRONIX, INC.  
816/737-1100

**Montana**  
OMEGA, LTD.  
303/758-1508

**Nebraska-Eastern**  
DY-TRONIX, INC.  
816/737-1100

**Nebraska-Western**  
OMEGA, LTD.  
303/758-1508

**Nevada-Northern**  
QUADREP INC.  
408/733-7300

**Nevada-Southern**  
VARIGON ASSOCIATES  
213/679-0621

**North Dakota**  
CAHILL ASSOCIATES, INC.  
612/646-7217

**Ohio-Northern**  
DOLFUSS-ROOT & CO.  
216/333-7504

**Ohio-Southern**  
DOLFUSS-ROOT & CO.  
513/433-6776

**Oklahoma**  
SIEMENS  
817/261-6543

**Oregon**  
RAY OVER SALES  
206/454-4551

**Utah**  
OMEGA, LTD.  
801/266-9617

**Vermont**  
KCA COMPONENTS, INC.  
617/861-9024  
ANCHOR ENGINEERING CORP.  
617/964-6205

**Virginia**  
J. A. MAGUIRE & CO., INC.  
301/377-0223

**Washington**  
RAY OVER SALES  
206/454-4551

**West Virginia**  
DOLFUSS-ROOT & CO.  
412/561-4125

**Wisconsin-Eastern**  
METCOM ASSOCIATES CORP.  
312/696-1490

**Wisconsin-Western**  
CAHILL ASSOCIATES, INC.  
612/646-7217

**Wyoming**  
OMEGA, LTD.  
303/758-1508

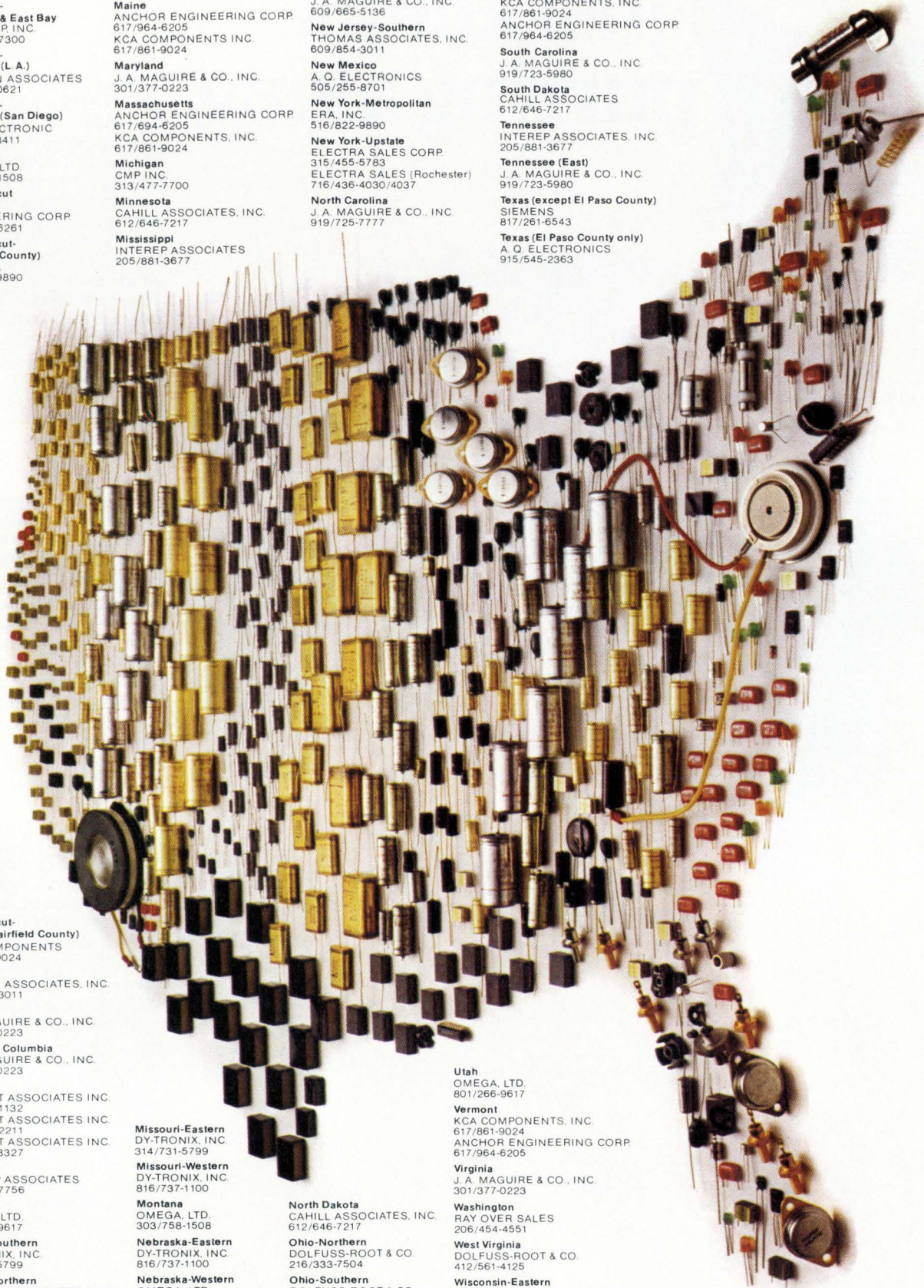



# When it comes to components, we're solid in every state.

Our strength comes from an 8 billion dollar company with over 550 million in worldwide component sales. Our sophisticated organization of salesmen and representatives and a distributor network with over 50 U.S. stocking locations is supported from strategically located U.S. manufacturing facilities with world-wide backup.

It's a complete service system designed to make your component buying a whole lot easier—north, south, east, and west.

We can anticipate and provide for your every component need, including: Tantalum, Aluminum Electrolytic, Ceramic, Film, Metalized Film, and Stacked Metalized Film Capacitors, Transistors, Zener Diodes, Tuning Diodes, Rectifiers, Hall Effect Devices, Ferrites, Flash Tubes, Voltage Protection Devices, LED's and LED Drivers.

To support future market requirements, Siemens spends 2 million dollars each working day in R&D. We maintain a dominance in high rel and commercial component production and have earned a reputation for quality and customer service that we go out of our way to protect.

To learn how Siemens and its products can be of service to you, wherever you may be, write or call: Siemens Corporation, Components Group, 186 Wood Avenue South, Iselin, New Jersey 08830, (201) 494-1000.

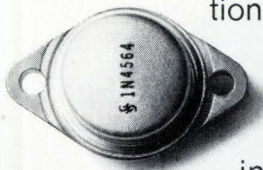

# SIEMENS

Circle 22 on reader service card

Electronics / August 5, 1976

## Meetings

tific Conference Management Inc. (Chicago, Ill.), New York Hilton Hotel, New York, Sept. 14-16.

**WESCON—Western Electronic Show and Convention**, IEEE, Los Angeles Convention Center, Los Angeles, Sept. 14-17.

**6th European Microwave Conference**, Microwave Exhibitions & Publishers Ltd. (Sevenoaks, Kent, England), Palazzo dei Congressi, Rome, Italy, Sept. 14-17.

**Convergence 76—International Symposium on Automotive Electronics and Electric Vehicles**, IEEE and SAE, Hyatt Regency Hotel, Dearborn, Mich., Sept. 20-22.

**International Broadcasting Conference**, IEEE *et al.*, Grosvenor House, London, U.K., Sept. 20-24.

**22nd Annual Holm Seminar on Electrical Contacts**, Illinois Institute of Technology and IIT Research Institute, Pick-Congress Hotel, Chicago, Sept. 21-23.

**Semicon/East 76**, Semiconductor Equipment and Materials Institute (Golden Gate Enterprises, Santa Clara, Calif.), Nassau Veterans' Memorial Coliseum, Uniondale, N.Y., Sept. 21-23.

**APL76—Putting APL to work**, ACM, Skyline Hotel, Ottawa, Canada, Sept. 22-24.

**Broadcast Symposium**, IEEE, Washington Hilton Hotel, Washington, D.C., Sept. 22-24.

**EASCON—Electronic and Aerospace Systems Convention**, IEEE, Stouffer's Inn, Washington, D.C., Sept. 26-29.

**MICRO-9—Ninth Annual Workshop on Microprogramming**, IEEE and ACM, Delta Towers Hotel, New Orleans, Sept. 27-29.

**Quality Testing Show**, American Society for Nondestructive Testing (Columbus, Ohio), Shamrock Hilton Hotel, Houston, Tex., Sept. 28-30.

# The one variable the world can standardize on.

Our new Type M conductive plastic variable resistor is hard metric. A 10 mm cube that's tiny, flexible and rugged. The MINI-METRIC is the smallest dual pot available today. Manufactured in the United States, it's dimensioned the way the rest of the world thinks. Allen-Bradley has what you need; or, it can be ordered through our distributors. Ask for Publication 5239.

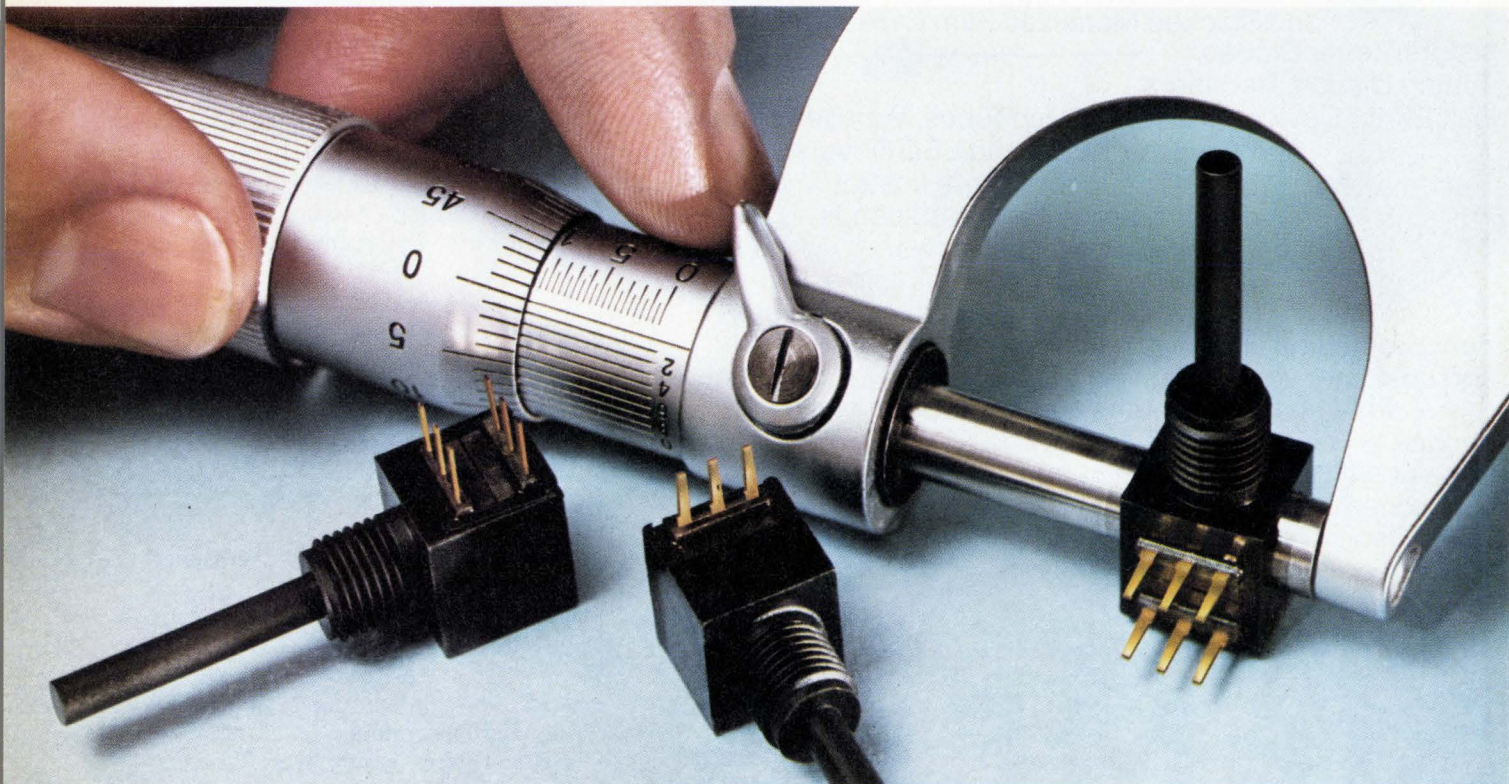
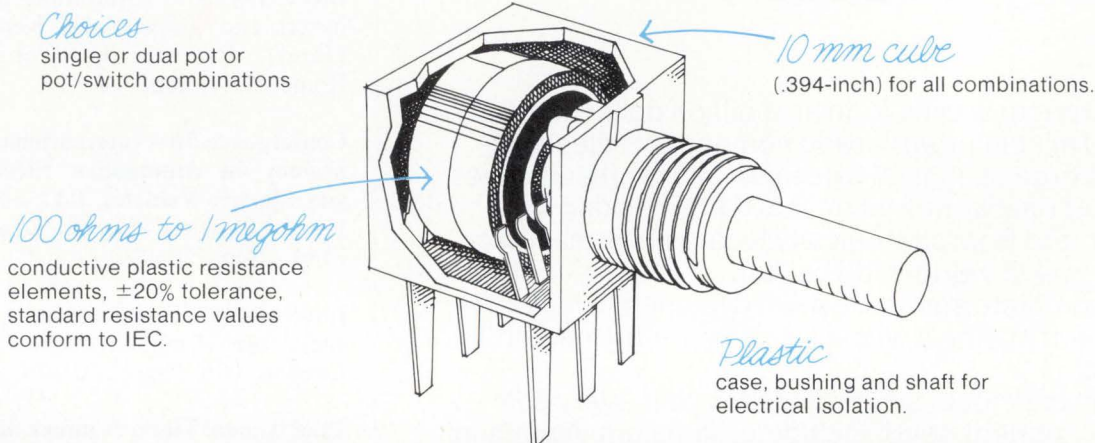

## Quality in the best tradition.



**ALLEN-BRADLEY**  
Milwaukee, Wisconsin 53204

EC131

### National hit by digital-watch production problems

National Semiconductor Corp., which recently straightened out production problems in its calculator product line, is taking another beating from its consumer product division. This time it's digital watches. **The problems are of such magnitude** that, according to Charles E. Sporck, president, "it will be difficult to make up the losses during the fiscal year ending May 31, 1977." Because of this, Sporck expects current quarter sales-operating rate to fall below the company's fourth fiscal quarter ending May 31.

The problems are in two areas—**watch module assembly, harmed by a four-week plant shutdown, at the Bangkok, Thailand facility, and more seriously, costly and still unresolved front-end yield problems with the company's new watch-chip designs** that are being readied for the next generation of low-cost watches. Although the company isn't commenting, this new C-MOS single-chip design was being billed internally as National's answer to Texas Instruments I<sup>2</sup>L watch chips. Nevertheless, according to Scott Brown, director of marketing for consumer products, the division has enough production capacity on hand to meet all commitments through Christmas.

### Pulsar sees solid, if not staggering, digital-watch sales . . .

**The 1976 worldwide market for solid-state digital watches will be 9.5 million units, less than half that predicted by some semiconductor houses,** estimates John M. Bergey, president of Time Computer Inc. in Lancaster, Pa., which makes the Pulsar digital watch. U.S. sales of solid-state watches are expected to be 60% of the total, or about 7.6 million units, he says, noting that last year 3.5 million digital watches were sold worldwide. "The market will continue to expand rapidly," and by 1980 worldwide digital watch sales will be about 53 million units, with U.S. sales representing 40% of the total, or about 21 million watches, he predicts.

### . . . and readies watch based on microprocessor

Meanwhile, Time Computer is busy developing a microprocessor-based digital watch set for introduction in the coming year. "The key to the microprocessor watch is not that it is going to perform many more functions, although it can, but rather that it can perform virtually anything wanted, depending on how it's programmed," says Bergey. **A single microprocessor chip with appropriate inputs and outputs can provide multiple functions: calculation, an alarm, interval timing, or whatever is wanted.** The Pulsar unit will use commercially-available microprocessors programmed with custom software.

### Intercity buses are moving toward automated inspection

Harris Corp.'s PRD Electronics division in Syosset, N.Y., is working with Greyhound Corp., Chicago, to develop **a computerized bus maintenance system that automates inspection procedure for engine, electrical, and air-conditioning systems.** A prototype PRD-built microprocessor-controlled diagnostic unit and associated cable/sensor assemblies is being evaluated by Greyhound, which is gathering data on how the system detects and isolates faults. After a two month evaluation, a decision will be made on large-quantity purchases of the system, which PRD has tabbed BMS 1000.

## Marines get OK for AV-8B Harrier development tests

The Marine Corps has cleared another hurdle in its push to acquire several hundred AV-8B Harrier vertical/short takeoff and landing fighters for its light-attack mission in the 1980s. Deputy Defense Secretary William Clements **has approved the Navy's plan for a basic flight demonstration phase of the development program.** The new plane, an improved version of the British AV-8A, would be produced jointly by McDonnell Douglas Corp., St. Louis, with developer Hawker Siddeley Aircraft Ltd. of the UK as principal subcontractor. **With improved electronics, including an angular-rate bombing system, and other aerodynamic changes, the AV-8B is expected to nearly double the performance capabilities of the original model.**

## NASA's shuttle gets first solid-state power controllers

The first airborne solid-state power controllers have been delivered for NASA's space shuttle orbiter, being built by Rockwell International. Westinghouse Electric, which developed the controllers, says each of the 600 solid-state units can remotely switch power loads—as well as function as thermal circuit breakers and current limiters—**with 10 times the reliability of their electromechanical predecessors, even though they are one-half their size and weight.** By combining thick-film IC technology and hybrid, bare-chip packaging with mean power transistors for high-power ratings, Westinghouse says it has come up with six different dc controllers with ratings ranging from 3 to 20 amperes. The highest power units approximate a cube measuring 1.75 inches on a side and weigh 5.1 ounces.

## LEDs to light up Ford vehicles

Watch for Ford Motor Co.'s first use of light-emitting diodes, but don't look on the instrument panel. Instead, the device—molded into a waterproof acrylic lens—is designed to throw a ring of amber light around the key locks on the driver and passenger doors as the exterior door handles are lifted. The system also turns on all the car's interior lights. **The illuminated-entry feature is controlled by an integrated circuit, protected by discretes and mounted under the dash, that also turns off the lights after 25 seconds or when the ignition key is turned.** The module is continually biased, but draws only a few milliamperes of current.

## Data General makes its minicomputers another step larger

With its new Nova 3/D, Data General Corp. is stretching its 16-bit Nova 3 minicomputer line upward, topping the earlier 3/12 [*Electronics*, Oct. 16, 1975, p. 32] by **including a 32-kiloword memory board and memory protection.** The machine also allows users to run dual operations, such as a multiterminal data-entry program in the foreground and a remote job entry or local batch program in the background, without having the programs affect each other. The memory board, which measures 15 inches square, uses 144 of Data General's own 4-kilobit n-channel MOS chips, which have 700-nanosecond cycle times. **At the same time, the Southboro, Mass., company is introducing its own line of terminal printers, including a 60-character-per-second unit.**



# Buy our boards now if you want to stop buying them later.

If you're thinking of making your own micro-computer boards sometime in the future, ours are the only boards to buy right now.

Because the chips on our microNOVA boards are the same ones you can buy in the microNOVA chip set.

Which means you can switch from microNOVA boards to our microNOVA chips anytime you want.

The microNOVA board is a full 4K micro-computer. With a number of standard features. Like power-fail/auto-restart. Real-time clock. NOVA instruction set with hardware stack. Hardware multiply/divide. Data channel logic.

Yet all the above computer costs only \$589, in OEM quantities of 100\*.

Which is a lot of computer for a little money.

Because it's a NOVA computer, the microNOVA board comes with powerful run-time software. Like

RTOS, our NOVA-compatible, field proven realtime executive. And it runs both Assembler and FORTRAN.

And because the microNOVA board comes from Data General, it comes with the manuals, technical publications, services, training courses and seminars you'd expect from a large minicomputer company.

Yet the microNOVA 4K board is only one member of an entire family. Besides the board (and all the supporting boards), you can get complete development systems. Or you can get completely packaged MOS minicomputers. Or chip sets that include the mN601 CPU, plus all the supporting chips.

So if you want to end up in the chips, call our toll free number, 800-225-9497. (Unless you're in Massachusetts. In which case, call 1-617-485-9100, EXT. 2509.)

**microNOVA:**

A giant reduction in the NOVA line.

## DataGeneral

Data General, Route 9, Southboro, Mass. 01772 (617) 485-9100. Data General (Canada) Ltd., Ontario.  
Data General Europe, 15 Rue Le Sueur, Paris 75116, France. Data General Australia, Melbourne (03) 82-1361

\*Prices quoted are FOB Southboro and apply to the U.S. Taxes excluded. NOVA is a registered trademark of Data General Corporation.



## The big memory family. In MOS, Bipolar and CCD together, nobody?

Or better. Because Fairchild is the memory leader.

So when you buy our memories, you get a lot more than a handshake and a carnation for your lapel.

You get at least 7 very tangible advantages.

And here they are.

### 1. You get more choice.

It's a fact. Of the five major sources today, no one gives you more choice in memory than Fairchild.

More off-the-shelf availability in both leadership parts and volume parts in all three of the technologies you need—MOS, Bipolar and CCD.

### 2. You get more ways to save.

One-stop Fairchild shopping means a lot more than convenience, too.

It means you can realistically package all of your memory requirements together for extra buying leverage—and important dollar savings.

### 3. You get more performance.

Leadership performance in every technology. In MOS, for example, our 16-pin 4K RAM and 2102 1K RAM are the n-channel industry standards.

In Bipolar, there's our industry standard 93415 1024X1 TTL RAM. Our unique 93422 256x4 TTL RAM. Plus our fastest-in-the-industry 2K and 4K PROMs. And our volume-production RAM in ECL.

Not to mention our CCD

450 1Kx9 Shift Register and CCD460 16K LARAM.

### 4. You get extra reliability.

Take our 16-pin 4K MOS RAMs. We 100 percent torture-test to assure against field failures—ask for our documented reliability brochure.

Or take our 93415 1K Bipolar RAMs. With 12,000,000 hours of test data, some customers have simply stopped incoming inspection.

Now *that's* confidence.



## Bigger than Fairchild.

### 5. You get it ahead of the game.

Fairchild is the leader in memory technologies.

So as new developments come along in memory technology—1<sup>3</sup>L, 16K MOS RAMs, 4K Static Bipolar RAMs—we'll bring you the devices you need to help you compete. And keep ahead.

### 6. You can get it when you need it.

Today, you'll find virtually every significant memory device

in volume production at Fairchild.

So if you need it in a hurry, we're the first place to call.

And when heavy market demand makes delivery hard to get, Fairchild's commitment to volume production and uninterrupted delivery can mean even more.

### 7. You get it at the best price.

Last, but not least, the way we look at pricing is this. To be expensive in the memory business is to be out of business.

So when we say we're competitive, we mean *competitive*.

For complete data on Fairchild MOS, Bipolar, and CCD memories, write or call your Fairchild Sales Office, Distributor or Representative today.

Fairchild Camera & Instrument Corp., 464 Ellis Street, Mountain View, CA 94042. Telephone (415) 962-4401. TWX: 910-379-6435.

The big memory family. Who else?

# FAIRCHILD

## WHO ELSE?

## HERMES LOOP ANTENNA

THREE SAMPLE SITES  
ON THE NORTH AMERICAN  
CONTINENT —

DIFFERENT LATITUDES  
DIFFERENT CLIMATE

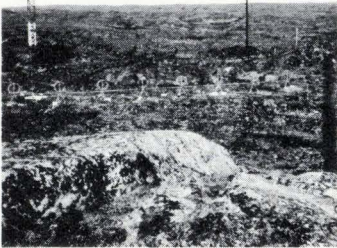

64°N



42.5°N

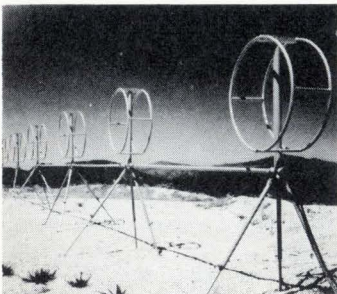

32.5°N

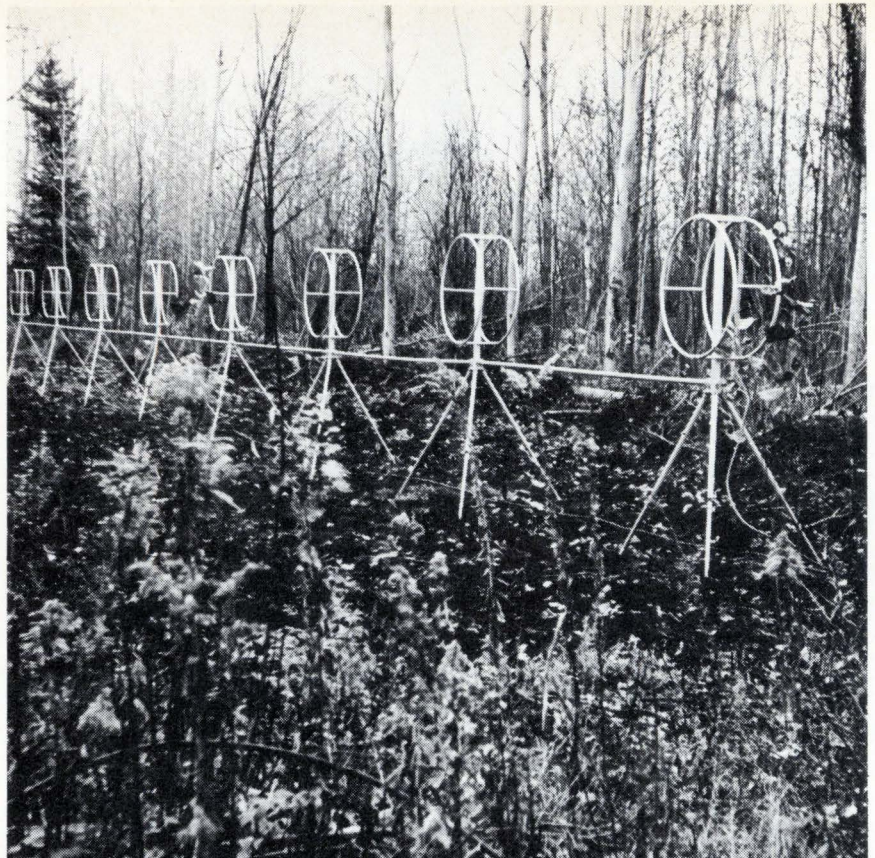

# Good Listeners maintain a low profile

Even in the solitude of the forest depths, from rooftops, arctic tundra, swamps to sweltering tropics, 'neath snow, sand or ice,

the Hermes Loop antenna keeps an ear to the sky.

The amazing aperiodic antenna does away with vast log periodic and rhombic arrays - those towering antenna farms.

In rosette configuration, the Hermes loop antenna provides an omnidirectional broadband receiving array in space merely 1/100th that of the traditional antenna farm.

More than 53 government agencies around the world have pressed the loop antenna into service.

A new, even more compact version is available. Only Hermes Electronics makes it.

**2-32MHz  
BROADBAND**



**ASK US Send for our Brochure**

Hermes Electronics Limited

Suite 315

2020 F Street NW

Washington, DC 20006 USA

202-296 2978

TWX 710 822 1106



## Copper tape set to carry IC chips

Motorola Semiconductor is counting on the copper to eliminate the contamination problems of film carriers

After declining to use film carriers for its integrated-circuit chips since the automation technique was introduced commercially about four years ago, Motorola Semiconductor Products has come up with a new approach.

Instead of plastic film, the Motorola division is using "film" made from a thin sheet of copper. And in a Scottsdale, Ariz., plant, it is running a fully automated line for mass-bonding to the copper 14- and 16-lead complementary-metal-oxide-semiconductor and diode-transistor-logic IC chips. The chips on the copper tape are then bonded to lead frames for dual in-line packages.

To cut labor costs, makers and users of large volumes of integrated circuits may bond the chips to reels of film, then use automated equipment to handle the chips and bond them into packages [*Electronics*, Dec. 25, 1975, p. 61]. But the film carrier, which combines copper interconnects fastened to a film base, can cause problems: when sealed into an IC package, the organic film material can contaminate the chip and threaten its reliability.

However, the copper approach does have disadvantages. Chips cannot be tested on the copper tape, as they can on the plastic film, because the copper serves as a common link to all the chips. Also, the insulating film serves as a protective medium

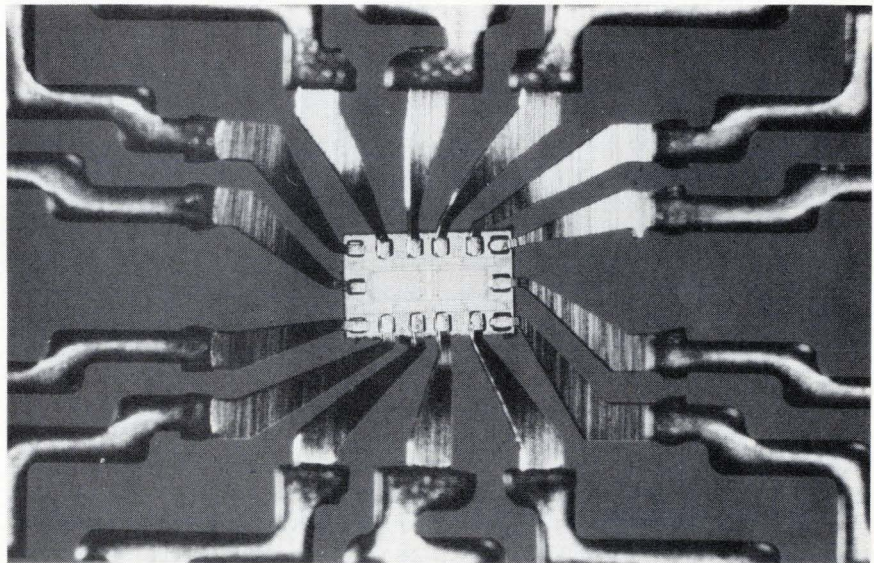

**Taped.** C-MOS chip is shown thermocompression-bonded to the interconnect pattern etched in copper tape used in Motorola's etched-chip-assembly or MESA process.

and support, whereas the copper tape needs an extra protective layer.

"We are aiming this approach at any high-volume IC chip line like TTL logic, as well as some of the popular linear operational amplifiers," says John Carey, Motorola's product-marketing engineer for saturated logic. "And we've received a lot of interest from hybrid manufacturers who want the chips on the copper tape. Any standard die can be accommodated." Motorola is willing to supply the chips in this way, he says, but details of price and chip types have yet to be worked out.

However, the chips on the tape would sell for somewhere between the price of a finished plastic dual in-line package and a bare chip.

The Motorola etched strip assembly, or MESA, technique is the first all-copper tape carrier to be announced, but at least one other IC

house, National Semiconductor Corp., is also working on one.

In the MESA process, the IC interconnect patterns are etched in the solid copper tape, and then pretested chips with built-up copper-pad-protection bumps are gang-bonded to the tape. Next, a plastic layer is placed over the bonded chips, and the two layers of material are reeled up. The plastic simply protects the chips and the copper interconnect. To apply the chips, the tape is then fed to machinery that peels away the protective plastic layer and gang-bonds the outer leads of the IC patterns to lead frames. After this step, the frames are molded into DIPs, which are cut apart and tested.

Eliminating the chance of contamination by the plastic is important enough to Motorola for it to have delayed introducing film car-

riers for more than a year while the copper-tape assembly line has been proving itself, Carey says. □

---

Medical

---

## Respiration rate cues pacemaker

A cardiac pacemaker controlled by the wearer's breathing rate has been developed at the University Clinics of Bonn, West Germany, and will soon undergo animal tests.

Together with a respiration sensor that's located at the pleura of the lungs, the new device exploits the relationship between respiratory rate and heartbeat. And, within certain limits, the device adapts its operation to the patient's physiological conditions.

A pacemaker keeps a sick heart going by supplying pulses to it at a fixed rate, typically around 70 pulses a minute. Most pacemakers furnish these pulses on demand—when the heart itself is too weak to beat. But, good as they are, these systems have a shortcoming: with a constant set frequency, they cannot satisfy the need for a faster heart beat when the patient is undergoing physical exertion.

This lack of variation has led Dr.

---

**Breath control.** Lab version of the respiration-controlled heart pacemaker being developed in Bonn, Germany, will soon be miniaturized. It will depend on a signal from a piezoelectric sensor (below) placed in the pleura of the lung to sense breathing rate.

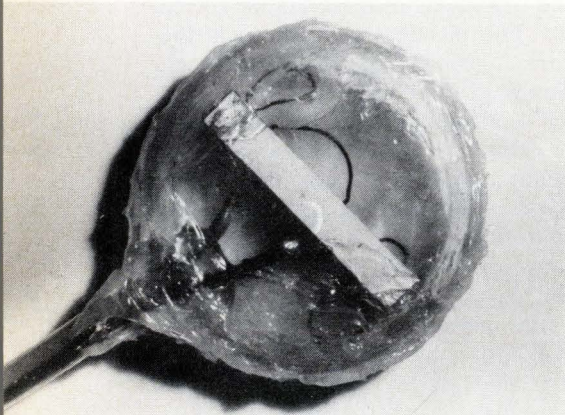

Hermann D. Funke at Bonn University's Surgical Clinic to develop the respiration-controlled, frequency-variable pacemaker. The device provides heart-stimulating pulses at a frequency that's always about four times higher than the respiratory rate.

With this 4:1 proportion, the device operates between about 60 pulses a minute when the patient is breathing at the slow rate of 16 times a minute and at 146 pulses a minute when breathing is more than twice as fast.

Funke, 34, a surgeon as well as a life-long electronics hobbyist, designed the new pacemaker entirely on his own—he even put it together with a soldering iron. "Within the next six months, an electronics firm will miniaturize the unit and produce several implantable versions for trials on dogs," he says. He won't say when his pacemaker will be tried on humans. Moreover, he would like to add a "demand" capability for his pacemaker.

**Ceramic sensor.** For sensing respiration, Funke uses a piezoelectric ceramic transducer that picks up the pressure at the pleura, the serous membrane covering the lungs where pressure varies as a function of

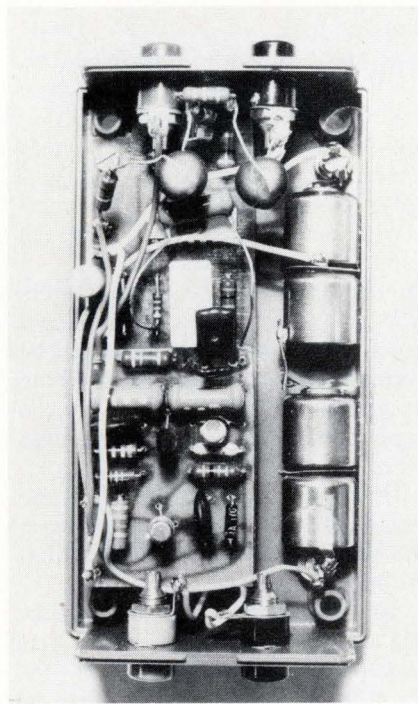

inhalation and exhalation. The sensor, shown in the photograph at the bottom of the page, is housed in a flat silicone-rubber package about 6 millimeters thick and 25 mm in diameter. Its output, a signal of 2 to 3 millivolts proportional to the respiratory rate, is applied to the pacemaker.

The signals first go to an impedance-converter/amplifier stage and then to a four-transistor monovibrator acting as a frequency-voltage converter.

At the vibrator output is a 1-microfarad capacitor that charges to a voltage level proportional to the respiratory rate. A pulse generator puts out a signal having a frequency that is proportional to the voltage across the capacitor. This signal is the output that serves to stimulate the heart.

**Time lag.** Designed into the pacemaker is a response lag of about 60 seconds. This, Funke explains, prevents abrupt changes in respiratory rate—changes that are often caused by coughing, for example—from affecting the pacemaker's output.

By tailoring the resistor values and by designing the monovibrator with a certain switching time, the stimulation frequency is prevented from exceeding 146 pulses a minute. And a diode in the capacitor's charge path insures that the frequency does not fall below 60 pulses a minute, the lower limit.

The pacemaker is powered by four mercury cells, each rated at 1.35 volts. The unit consumes about 3 microamperes in its quiescent, that is non-implanted, state. When implanted, and pulsing, it should require about 8 microamperes. □

---

IEEE

---

## U.S. activities board releases game plan

A \$1 million-plus proposal aimed at the professional and career concerns of its members has been completed by the Institute of Electrical and

Electronics Engineers. Moreover, in a complete break with precedent, the IEEE is opening the 24-task program, developed by its 16-member U.S. Activities Board, to critique by grass-roots members.

**Activist role.** Likely to draw the most criticism—both pro and con—are the tasks that appear to lead the IEEE into a more activist career role than in the past. For example, under the heading of professional status improvement, the activities board calls for “higher standards for graduation and entrance into the profession” as a means of enhancing the electronic engineer’s professional image. There’s also a plan to define the role of engineering technologists more narrowly, to reduce the tendency in industry to replace engineers with less-well-prepared and lower-paid technical-school graduates.

Nevertheless, the tasks stop short of calling for the direct control of the quality and quantity of engineering graduates. And it presents an approach to age discrimination abuses that is without much in the way of teeth.

The plan, under development since January by the activities board, whose members are also on the IEEE’s board of directors, now goes for comment to all chairmen of sections and professional activities committees across the country. It will also be printed this month in *Spectrum*, the IEEE’s publication.

As much feedback as possible from members, no matter how harsh their reaction, is a prime objective of IEEE vice president of professional activities and activities-board head, James H. Mulligan, Jr.

“It’s important for all members to understand that their ideas will be heard and considered,” he says.

While IEEE has often claimed in the past to be open to input from the grass roots, many members have complained of a gulf between themselves and the leadership. Mulligan is not only aware of this feeling—he maintains that he is not adverse to ruffling the usually calm exterior of the institute and will even seek comments from outside the institute. “Being willing to stand up and take

criticism is a start toward improved communications,” he says.

Mulligan expects the plan to be a springboard into the 1977 program. He also intends to modify the 30-plus-page document on the basis of the reactions he receives.

The five goals under which the different tasks are grouped seek to improve financial and economic benefits for members (five tasks with a budget for staff and research expenses of \$201,300); improve career

conditions and opportunities (eight tasks and \$158,900); improve professional status (three tasks and \$31,900); improve communication to members of the activities board’s aims, activities and accomplishments (four tasks and \$114,100), and improve relations with Government “and other interfaces” (four tasks and \$225,800). Four other tasks bring the total to \$1.067 million, which, the IEEE says, will be expended during 1976. □

---

## Consumer

---

### I<sup>2</sup>L for camera shutter relies on available light, needs no battery

A camera circuit made of integrated injection logic is being developed that is sensitive enough to run off a photocell and so is not a drain on the battery conventional electronic cameras must have.

The I<sup>2</sup>L circuit, a light-to-frequency converter, could be the heart of an inexpensive timer for the camera shutter. It has been built by a supplier of custom integrated cir-

cuits, Micro Components Corp., in Cranston, R.I. (see “Kodak’s Cranston connection,” below) and operates off the available light that comes in through the camera lens.

The extremely low power required by I<sup>2</sup>L—0.3 picojoule per gate—is what makes the no-battery operation possible, the company points out. The circuit is able to operate from only the tens of nanoamperes devel-

#### Kodak’s Cranston connection

Micro Components Corp. is the former integrated-circuit operation of Amperex, subsidiary of North American Philips. Officials at Amperex bought the manufacturing facility in Cranston, R.I., and set up their own company when Amperex made the decision to get out of the integrated-circuit business four and a half years ago. This occurred during the business downturn at that time, when Sylvania, General Electric, and Westinghouse Electric also abandoned the commercial production of integrated circuits. The new owners of the Amperex facility chose the new name and continued to supply ICs to Eastman Kodak Co. for control of the Instamatic camera shutter—business Amperex had won.

Alfred S. Budnick, president, says MCC’s large-volume delivery on the Instamatic contract was the clincher when Kodak sought suppliers of a similar circuit for the recently introduced Instant unit. MCC, National Semiconductor Corp., Santa Clara, Calif., and Vactec Inc., Maryland Heights, Mo., also supply the circuit.

For the Instant camera, MCC puts the two chips—a photodiode and linear IC—in an eight-pin clear-plastic miniature dual in-line package. The unit performs four functions: It selects one of two possible apertures, depending on ambient light levels, times the automatic shutter, and indicates low light levels and low battery power.

Budnick says Micro Components has delivered millions of the circuits to Kodak. And the numbers of delivered circuits jump to many more millions when the circuits that the company has supplied for the Instamatic camera are taken into account.

oped by a photodiode when it is struck by the incident light. This tiny current is enough to drive the converter to produce an output of 400 to 500 millivolts, peak to peak, at frequencies ranging from 100 hertz to 1 megahertz depending on the light intensity.

**Demo wafer.** So far, Micro Components, which claims to be the major supplier of integrated circuits for the Eastman Kodak Co.'s fast-development camera [*Electronics*, April 29, p. 31], has produced only a demonstration I<sup>2</sup>L wafer that includes the light-to-frequency converter, among other devices. But Andrew Durette, vice president for engineering, is confident that an integrated injection logic IC using the technique can be produced and sold for from 50 cents to \$2, compared to between \$2 and \$5 for a more conventional approach.

The converter circuitry on the demonstration wafer includes a photodiode detector that drives a seven-stage ring oscillator built with I<sup>2</sup>L transistors functioning as inverter gates.

**Current control.** The ring oscillator is current-controlled. Durette explains that a voltage-controlled oscillator, the more conventional device when it comes to converting current to frequency, is harder to build in I<sup>2</sup>L.

The seven-stage unit oscillates at a frequency directly proportional to the light level; if the light input to

the photodiode is doubled, the diode's current output doubles, and so does the output frequency. The oscillator includes a buffer amplifier whose output can drive a load—a field-effect transistor or some other high input-impedance device.

**More to be added.** When the light-to-frequency converter, which measures only 12 by 36 mils, goes beyond the demonstration stage, I<sup>2</sup>L counting circuitry will be added to complete a device needed to control the camera's shutter timing. The whole circuit will then be put into its own monolithic chip in the type of transfer-molded clear plastic package used for the circuit supplied by Micro Components to Kodak.

The complete controller for the camera will still need battery power for operating the shutter, but Micro Components points out that its IC approach will substantially reduce the power required, boosting battery life.

Charles Grandmaison, the company's vice president for marketing, says a circuit made with a more conventional approach but in other respects comparable to the I<sup>2</sup>L light-to-frequency converter requires—in addition to a battery or power supply—the photodetector, voltage-controlled oscillator, digital-to-analog converter, a counter, operational amplifier, and a gate. Micro Components does it simply with the photodiode, ring oscillator, output buffer, and counting circuitry. □

areas—gun, deflection angle and glass—was always to improve the product and reduce costs for our own product line. Previously Zenith was the first with the Chromacolor negative-guard-band tube, and the rest of the industry went along with it. The same will be true with this tube."

Regarding a tri-potential gun for large-screen tubes, there's little question that the industry will come around to Zenith's approach. (In-line, self-convergent tubes are already found in small-screen receivers.)

Almost everyone who has evaluated the tube has praised its improved picture resolution. The three distinct potentials produce extended-electron-field lenses that create a smaller spot on the screen. Indeed, both GTE-Sylvania and RCA's Picture Tube division have announced plans to build in-line color tubes with tri-potential guns. And set makers like Magnavox Corp., Admiral Group of Rockwell International and Quasar Electronics Corp. agree the picture improvement warrants a shift away from the present delta-configuration bi-potential guns for large-screen sets.

General Electric's Television Business department, however, has rejected the Zenith tube. According to Fred Welner, general manager of the department, a three-month technical and cost analysis led GE to conclude there was no improvement in perceived picture quality.

But it may be a couple of months yet before it's clear how the industry will go in using the 100° deflection angle offered by Zenith. Horn argues that 100° is an optimum tradeoff between the 90° used in the U.S. and the 110° used in Europe for reduction in spot size (12.5% smaller compared to 90°), power consumption, and distortion at the edges.

**Not too different.** RCA's J. J. Brandinger, vice president of television engineering for the Consumer Electronics division in Indianapolis, disagrees: "90° and 100° deflection tubes are not different enough to make the change. What you gain in some performance specifications, you lose in the increased tempera-

---

## Zenith appears to be only set maker to adopt new color tube for TV line

Despite mixed reactions from other television-set manufacturers, Zenith Radio Corp. intends to go it alone if need be in using its new 19-inch Able color-picture tube in TV sets. And the first sets to use the tube are entering production.

The other set makers, though impressed with the tube's tri-potential gun and in-line, self-convergent design [*Electronics*, March 18, p. 39], are unsure about shifting to the tube's 100° deflection angle from the

conventional 90°. They disapprove of the tube's larger glass shell and its shadow mask, which were developed jointly by Zenith and Corning Glass Works. They also question whether they'll realize the savings that Zenith claims the new tube's automated production makes possible. But Zenith isn't worrying.

**Another first.** Says Karl H. Horn, Zenith's senior vice president for engineering and research in Chicago: "Our objective in the three major

# Announcing Intel's CCD replacement for disc and drum memories.

Now you can replace small, fast access, disc and drum memories with Intel's new solid state CCD memory called IN-65 Megachassis™. Each Megachassis contains 2 megabytes of CCD serial memory with expansion in 2 megabyte increments up to 16 megabytes or more.

Built with Intel™ 2416 CCD serial memory components, the IN-65 Megachassis™ gives you solid state reliability and low power. And since all components are on plug-in, circuit boards trouble shooting and repair time are greatly reduced.

In most applications this new 2 megabyte CCD Memory will be utilized as a block-oriented random access memory (BORAM). It can transfer data of variable block lengths at rates up to one word every 550 nanoseconds. Since worst-case latency is only 256 microseconds, the IN-65 can also be used in applications that are beyond the capability of most conventional rotating memories.

If you'd like more information, use the bingo card and we'll send you a IN-65 Megachassis™ product description. If you're in a hurry, use the coupon, or write: Intel Memory Systems, 1302 N. Mathilda Avenue, Sunnyvale, California 94086.

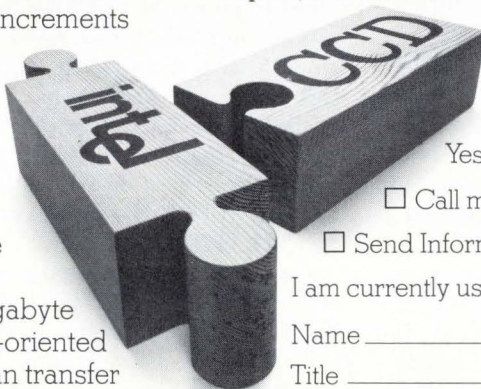

Yes, I'm interested in the IN-65.

Call me. Tel. No. \_\_\_\_\_

Send Information.

I am currently using: \_\_\_\_\_

Name \_\_\_\_\_

Title \_\_\_\_\_

Company \_\_\_\_\_

Address \_\_\_\_\_

City/State/Zip \_\_\_\_\_

**intel memory systems**  
A DIVISION OF INTEL CORPORATION

Circle 35 on reader service card

ture of the chassis, increased cost of components to protect solid-state devices from higher tube voltage, and increased power demand."

But if the choice depended on the glass alone, Zenith would have a lemon on its hands. Nary an encouraging word can be found in the industry for the tube envelope. In Japan tube makers have been cautious, but have tended to side with U.S. firms regarding the glass.

Comments Richard Kraft, vice president of engineering for Quasar Electronics Corp., Chicago: "I feel that the TV industry will reject the new glass simply because we don't see the cost reductions. The mechanical tolerances on the new glass are not as tight as for standard glass, so if we were to relax the tolerances on standard glass to the same degree, the same cost savings could be had. In addition, the new tube has over an inch larger face plate on the 19-in. set, and some cabinet tooling would have to be changed to accommodate the tube."

Horn responds that Zenith has not had to retool to fit the Able tube into its cabinets. "In two to three years you will see the assessment of the industry. Competitors say we've goofed, and maybe they're right. But we will take odds we're right." □

### Military

## Avionics for CP-140 to top \$200 million

By combining the advanced avionics of its carrier-based S-3A Viking submarine hunter with its long-range P-3 Orion airframe, Lockheed-California Co. has come up with a \$697 million 18-plane package for Canada.

Lockheed-California vice president R.R. Hepe says "it's the largest single export sale" in the company's history. And Canada's order for 18 of the new planes, designated the CP-140, will provide more than \$200 million in avionics business for U.S. and Canadian avionics and ground system suppliers.



**New combo.** CP-140 bought by Canada for submarine surveillance combines Lockheed-California Co.'s P-3 Orion airframe with avionics developed for the carrier-based S-3A Viking sub hunter. Canada also plans to use the craft for detecting forest fires.

But Lockheed is not out of the woods yet, despite its success in working out an agreement with Canada for 1980-1981 delivery of the new planes. "We still must negotiate subcontracts for the avionics," says CP-140 deputy program manager Phil Sullivan. However, some of the S-3A avionics and sensor makers may complete production and shut down lines before Lockheed will be ready to install the subsystems. So the subcontractors may be asked to restart lines or "build the equipment and hold it for us," says Sullivan.

Three suppliers of CP-140 electronics hardware have already been named. Biggest of these is Litton Systems Ltd., which will provide two ground systems known as DIAC—data interpretation analysis centers—used to analyze and support CP-140 missions. Along with a ground-support computer complex from Sperry Univac, the price tag for these systems is put at \$35 million. General Dynamics Corp. will build the ground-support system known as HATS—hybrid automatic test set—which Sullivan says could cost less than \$10 million.

**Canada's share.** Litton's subsidiary is also among the Canadian suppliers who will displace U.S. vendors for on-board systems. Under the contract's provisions, Canadian companies get nearly \$415 million in business from the program. Litton will provide the LN-33 inertial guidance, and Canadian Marconi, the

Doppler navigation system. Singer Kearfott has been the U.S. supplier of both these systems. Similarly, CAE Electronics Ltd. will displace Texas Instruments as supplier of the AN/ASG-501 magnetic-anomaly-detection system used on the P-3.

But all is not lost for TI. It will provide the AN/APS-116 radar that's on the S-3A as well as the forward-looking infrared system. Other S-3A equipment to be used include Sperry-Univac's AN/AYK-10 computer, Lear Siegler's automatic flight-control system, and IBM's AN/ALR-47 electronic countermeasures system, used in conjunction with Sanders Associates' OL-82 acoustic data processor.

Cubic Corp. will provide the AN/ARS-2 sonobuoy reference and positioning system used on the P-3C, while Rockwell's Collins Radio Co. will continue as supplier of radios, the AN/ARC-153 and the AN/ARC-156 systems. Similarly, Loral Electronics will supply the cathode-ray-tube displays. □

## B-1 ECM gear begins tests

While advanced-procurement funds for production of the Air Force B-1 bomber are still under fire in Congress, development of the controversial system's avionics continues. The Senate recently postponed

# RCA power transistors: More Value per Penny.

**Socket for socket, penny for penny, RCA direct replacement types give you all these reliability extras:**

- Thermal Cycling Characterization, to help you predict in-service reliability.



- Real Time Thermal Process Control, to help insure that every transistor you get has the reliability you expect.
- Safe Operating Area Characterization, so you can determine performance under virtually any operating condition.
- Clip Lead Construction, for extreme ruggedness.
- Steel Headers, for even greater reliability.

## RCA replacements for TIP and DTS types

TIP 29	RCA 29	TIP 31	RCA 31	TIP 41	RCA 41	DTS 410	RCA 410
TIP 29A	RCA 29A	TIP 31A	RCA 31A	TIP 41A	RCA 41A	DTS 411	RCA 411
TIP 29B	RCA 29B	TIP 31B	RCA 31B	TIP 41B	RCA 41B	DTS 413	RCA 413
TIP 29C	RCA 29C	TIP 31C	RCA 31C	TIP 41C	RCA 41C	DTS 423	RCA 423
TIP 30	RCA 30	TIP 32	RCA 32	TIP 42	RCA 42	DTS 431	RCA 431
TIP 30A	RCA 30A	TIP 32A	RCA 32A	TIP 42A	RCA 42A		
TIP 30B	RCA 30B	TIP 32B	RCA 32B	TIP 42B	RCA 42B		
TIP 30C	RCA 30C	TIP 32C	RCA 32C	TIP 42C	RCA 42C		

## More Value per Penny in over 500 types.

RCA has a broad line of power transistors – the table shows only our replacements for TIP and DTS types. And all are known for quality, performance and manufacturing innovations. Choose from high speed switching types. High voltage types. Rugged commodity types.

Hometaxial and epitaxial constructions. In both hermetic and plastic packages. All have the RCA reliability extras. All give you More Value per Penny.

## Your guide to More Value per Penny in RCA power transistors.

Get the RCA Transistor Interchangeability Guide. You'll see hundreds

more replacements. All with More Value per Penny.

Your RCA Solid State distributor has these Interchangeability Guides now. Or write RCA Solid State, Box 3200, Somerville, N J 08876; Ste. Anne de Bellevue H9X 3L3, Canada; Sunbury-on-Thames, U.K.; Fuji Bldg., Tokyo, Japan.

# RCA

RCA. Powerhouse in Transistors

# RF power

We've made the most of it...  
You can, too!!

All wrapped up in a neat little package, our Model 510L is an ultra-wideband RF power amplifier whose wide range of frequency coverage and power output provide the user with the ultimate in flexibility and versatility in a laboratory instrument. Easily mated with any signal generator, this completely solid state unit amplifies AM, FM, SSB, TV, pulse and other complex modulations with a minimum of distortion.

Constant forward power is continuously available regardless of the output load impedance match making the 510L ideal for driving highly reactive loads.

Unconditional stability and instantaneous fail-safe provisions in the unit provide absolute protection from damage due to transients and overloads.

This outstanding unit covers the frequency range of 1.7 to 500 MHz with a linear power output of more than 9.5 watts and there is no tuning.

For further information or a demonstration, contact ENI, 3000 Winton Road South, Rochester, New York 14623. Call 716-473-6900 or TELEX 97-8283 E N I ROC

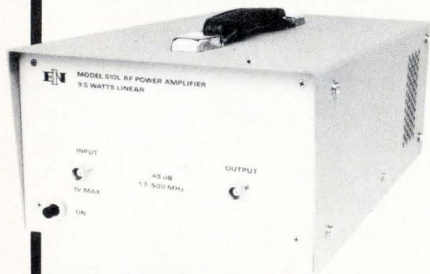

## ENI

The world's leader  
in solid state power amplifiers

## Electronics review

### News briefs

#### FCC sends Bell back to 900-MHz drawing board

The changes proposed by Illinois Bell Telephone Co. in its \$23.5 million plan to develop a 900-megahertz cellular land-mobile communications system have made the Federal Communications Commission decide to reject the entire plan unless the company provides additional technical, operational, and financial data. In its first technical proposal on the system [*Electronics*, Jan. 3, 1972, p. 100], American Telephone & Telegraph Co. and its Illinois affiliate proposed a system made up of hexagonal cells for the Chicago metropolitan area; each cell was to have had a four-mile radius and three directional antennas at alternate corners, enabling frequency reuse at distances of about 18 miles. The FCC says Illinois Bell now proposes to substitute eight-mile cells with a taller omnidirectional antenna at each cell center, limiting frequency reuse to two of the proposed 10 cells every 48 miles.

Moreover, the FCC says channel separation has been reduced to 30 kilohertz from the 40 kHz originally planned. And the 11.88 megahertz of spectrum spread over 21 MHz conflicts with the FCC's earlier authorization of no more than 12.5 MHz in two contiguous blocks of 6.25 MHz each for the developmental system's base stations and mobile units.

The FCC also charges that Illinois Bell has failed to give adequate detail about its proposed \$23.5 million cost figures. The company has 60 days from the July 20 decision to decide whether it will amend its application with additional data, or apply for a limited developmental cellular system for technical testing purposes. The FCC made clear it is still interested in seeing a test of "the sophisticated, small-cell configuration envisioned" earlier.

#### NEC, Intel join in cross-licensing agreement

The initial result of a worldwide royalty-free patent cross-licensing agreement between Nippon Electric Co. Ltd. of Japan and Intel Corp. will be compatibility between the two companies' microprocessor products. The agreement covers all semiconductors, but both companies are strong in microprocessors and memory devices. In fact, NEC Microcomputers Inc., Nippon's Bedford, Mass., subsidiary, is at present aggressively marketing LSI memory products and an 8080A microprocessor line in the U.S.

#### Cambridge Memories ceases operations

Hit by a cash shortage when lending banks demanded repayment of \$16 million in loans, Cambridge Memories Inc., Bedford, Mass., has suspended all operations. The manufacturer of IBM-compatible add-on memories has furloughed 350 persons.

until February expenditure of \$1.05 billion for the first three production models and other advanced items when a new Administration will occupy the White House, but the move may be defeated in the House. Nevertheless, system suppliers remain optimistic and are pursuing their development programs hard.

One such contractor, Cutler-Hammer, Inc.'s AIL division, Deer Park, N.Y., has begun test and evaluation of its \$57 million effort on a radio frequency surveillance/electronic countermeasures system for the Rockwell International aircraft. AIL's technology developed for

USAF's Aeronautical Systems division is looking far beyond the present political hassle.

"We are preparing for the year 2,000 by designing a system with the flexibility to change parameters via software, as new threats come on the scene," says Michael J. Philbin, AIL's B-1 program manager.

The defensive system, which had to be designed from the ground up to achieve such programability, will detect the electromagnetic environment in which the B-1 flies, categorize the detected signals, establish the degree of danger that the signals represent to the aircraft, and deter-



# 8080 or 6800. iCOM's Floppy Works With Both.

## 8080

Even if you already have a development system, iCOM's floppy disk will speed up your program development by a factor of 20 over paper tape. Remarkably, iCOM's FDOS-II, although standard, is the most powerful package you can buy. It offers variable length contiguous files, auto create, open and close, multiple merge and delete . . . and much more. Memory requirements are minimum, too. And all you have to do is plug it in. Just select the inexpensive interface package for your computer.

### For Intellec\* MDS-800 or Intel's\* SBC 8010

iCOM's FD-360-53 provides plug-in interface and FDOS-II, including assembler and editor. It works with standard 16K RAM, yet gives you industry's most powerful FDOS. For SBC it takes just 8K of memory. iCOM's FD-360-53 is easier to use than Intel's disk and it can easily be adapted for OEM volume applications.

### For Intellec 8/Mod 80

iCOM's FD360-51 gives you a plug-in interface which connects to a standard Intel imm 8-61 i/o card. Powerful FDOS-II software is included. Only 8K of RAM is required. Hundreds of Intellec-8 users rely on iCOM floppy disk systems to speed their 8080 development. Complete cost for a dual drive system is just \$3000.

### For 8080/OEM or Custom System

Order iCOM's FD360-54. It requires only three 8-bit latches to complete the interface. Included is iCOM's powerful FDOS-II 8080 OEM package which is easily installed on any 8080 system. It's perfect for Altair & IMSAI too.

## 6800

If you have an M6800 EXORciser\*, Motorola can provide you with a fine floppy disk system complete with development software. If, however, you have an M6800 evaluation module or your own M6800-based system, iCOM has the solution to your problem.

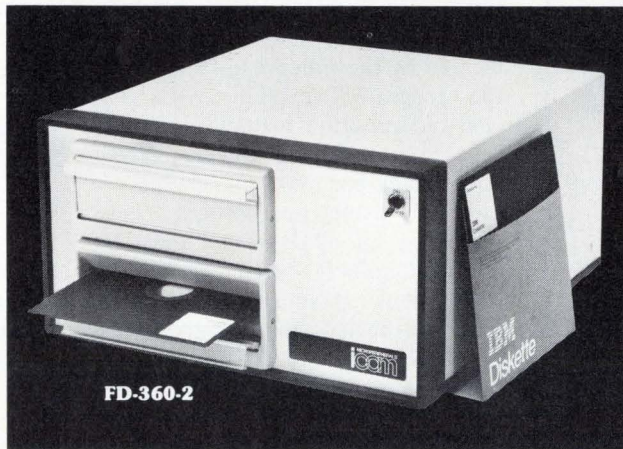

### M6800 Evaluation Module

Use iCOM's 360-68 EVAL package, and 8K of RAM on your Evaluation Module gives you a ready-to-use development system at minimum cost. It also provides you with the tools to easily integrate an iCOM floppy disk into your end product. If you have an Evaluation Kit, we'll tell you how to configure it to use the iCOM Floppy.

### 6800 OEM Applications

What could be simpler? Just two PIA chips (type 6820) will interface an iCOM floppy disk plus a paper tape reader or line printer.

### Shown: iCOM's Dual Drive System

iCOM has complete, ready-to-go floppy disk systems for virtually every microprocessor on the market. Systems can be installed in minutes, are fully hardware and software compatible and contain the most powerful FDOS available.

You can choose from 1 to 4 drives: desk top, rack mount, or the Frugal Floppy™ subsystem ready for integration into your own equipment cabinet. iCOM floppy disk systems cost less than others, yet do much more. Delivery is fast, too. So turn on your microprocessor project today with an iCOM floppy.

\* EXORciser is a trade mark of Motorola. Intel & Intellec are trademarks of Intel Corp.

another first  
from  
Grayhill



## 16 positions in a dime-sized switch!

Now in demand for  
octal and hexadecimal  
applications

- 1/4 amp, 1/2 inch switch  
single or double-pole  
with 16 positions in a single deck
- occupies only 1.1 cubic inch  
behind panel
- contamination-free enclosed  
construction, molded-in terminals

This new addition to the popular Grayhill Series 51 Rotary Switch family meets the growing number of applications calling for the maximum number of positions in the minimum amount of space. (Previously available 16 position switches had diameters of 1-1/3 inches instead of 1/2 inch!) And you'll be pleased with the performance and price of these switches too...rated for 25,000 cycles of operation, priced about \$6.00 in 100 quantities.

New Product Bulletin #257 contains complete specs and price information...free on request from the leaders in switch miniaturization, Grayhill, Inc. 561 Hillgrove Avenue, La Grange, IL 60525 (312) 354-1040.



## Electronics review

mine the jamming action to be taken. And then, it automatically controls the jamming.

"It's a totally new concept and approach," declares Hans Peot, chief of the Air Force's B-1 Avionics division at Wright-Patterson Air Force Base in Ohio. With present countermeasures systems, Peot notes, a change in threat dictates a change in both hardware and software.

**Brand new.** The AIL system has about 70 black boxes of nearly 35 different types. Philbin claims it "is really the only brand-new integrated avionics subsystem on the B-1 aircraft."

However, the boxes are spread all over the aircraft because the defensive system is a Johnny-come-lately. "The offensive system was already located by the time we got started on the program," explains AIL's 42-year-old program manager. "Wherever we found a nook and cranny, we put a black box."

AIL is using microprocessors to process a lot of data that must be handled quickly, such as categorizing detected signals as friend or foe. The devices for doing this are high-reliability versions of commercially available microprocessors in three line-replaceable units. "The microprocessor-based LRUS allow us to use a general-purpose computer as simple as Litton's LC-4516D [16-bit, 32-kiloword central processing unit] to do some of the slower routine functions," says Philbin.

In June AIL's effort was expanded with an additional \$2.1 million for "closed-loop" testing of the system. Its purpose is to insure compatibility among the various emitters and receivers *before* it all is placed aboard an operational craft.

The tests are also to give the service the option of moving up the defensive system's production schedule to avoid retrofitting the systems to B-1s that precede it off the assembly line.

**Hot mockup.** The countermeasures system will be tested on a hot mock-up of an operational B-1 at a facility at Edwards AFB in California. Threats will be simulated from a tower, and isolation will be measured

to determine if the system's transmit and receive antennas are interfering with other systems. "If they are, we will then come up with some blanking techniques so that we don't jam ourselves," says Peot.

Regarding income from the system, "AIL could realize \$1 billion in sales spread over eight to 10 years," says Philbin. As currently planned, this would include defensive systems for more than 240 B-1s, spares, manuals, and ground equipment that the firm expects to develop and build in-house. About 30% of AIL's funding would go to its three principal subcontractors: Litton Industries for the central computer, Northrop Corp. for terminal-threat antennas operating at classified frequencies, and Sedco Systems Inc. for phased-array transmitter antennas. □

## Problems slight on Viking mission

So far, the problems that plague any unmanned space mission have proved to be small and easily corrected for the Viking I spacecraft. Now sitting on the surface of Mars, 213 million miles from earth, the craft is busily transmitting television pictures, both in color and black and white, after orbiting the planet for an extra 16 days (until July 20), looking for a smooth place to land.

Potentially, the most serious trouble was a steel pin that jammed its all-important mechanical arm that is to scoop up samples of Martian earth for lander instruments to analyze. This pin, which should have dropped free when the arm was extended from the craft, instead hung in the undercarriage that supports the arm and shovel-like soil-collector head.

Engineers at both Jet Propulsion Laboratories, which is running the project from Pasadena, Calif., and Martin-Marietta Corp.'s Aerospace division in Denver, ran a series of tests on full-scale models that spotted the problem. To correct it, JPL sent a series of new commands to extend the arm farther, or about 14

# NEW

## PRICE/PERFORMANCE BREAKTHROUGH



Now! 0.1% Accuracy On All 5 DC Voltage Ranges

# SIMPSON

## MODEL 464

### Digital Multimeter

USE IT EVERYWHERE:  
In Field or Factory  
Production Line Testing,  
Laboratory, R & D, and for  
General Electronic Servicing.

- 3½ Digit, 0.43" LED Readout
- Highly Reliable LSI Circuitry
- Bi-Polar Operation and Automatic Zero
- Full Pushbutton Selection of Ranges and Functions
- 28 Ranges: 6 AC current ranges to 10 amps  
6 DC current ranges to 10 amps  
6 resistance ranges to 20 megohms  
5 AC voltage ranges to 600 volts  
5 DC voltage ranges to 1000 volts

- High Accuracy:  $\pm$  (0.1% of reading + 1 digit) on all 5 DC V Ranges (+15 to 35°C)
- Choice of Battery/AC Line Combination or AC Line Operation Only
- High Impact Shock-Resistant Case with Tilt-View, Adjustable Handle
- Conforms to Applicable ANSI C39.5 Requirements

**Model 464A** line operation . . . . . \$210.00  
**Model 464D** line and battery operation . . . . . \$247.00

ORDER FROM YOUR ELECTRONICS DISTRIBUTOR  
**SIMPSON ELECTRIC COMPANY**  
853 Dundee Avenue, Elgin, Illinois 60120 • (312) 697-2260  
CABLE: SIMELCO • Telex: 72-2416  
IN CANADA: Bach-Simpson, Ltd., London, Ontario  
IN ENGLAND: Bach-Simpson (U.K.) Ltd., Wadebridge, Cornwall  
IN INDIA: Ruttonsha-Simpson Private, Ltd., Vikhroli, Bombay

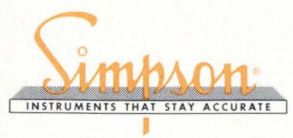

# **SCIENCE/SCOPE**

Now, with the launch of the second Marisat, the new maritime communications satellite system blankets the sea lanes in a 120-million-square-mile area of the Atlantic and Pacific. For the first time, ships can communicate clearly and without interruption with other ships and with shore bases. The two Marisat spacecraft -- built by Hughes for COMSAT General Corporation -- are relaying high-quality voice, telex, facsimile, and data transmission. Vessels flying the flags of 10 nations already are equipped for satellite communications. The U.S. Navy also is leasing a substantial portion of Marisat's capacity for its fleet communications needs.

Men at sea have depended in the past primarily on international Morse code and radio telephony that often was disrupted and delayed by adverse weather conditions, signal fading, or crowded frequency channels. The Marisat system has eliminated these delays.

Marisat earth stations in Connecticut and California, interconnected with terrestrial networks and linked by 24-hour voice and data lines to COMSAT General's Washington, D.C., control center, complete the Marisat satellite system.

Digital watch modules with three new features have been introduced by Hughes. One is both a regular watch and a stopwatch (or chronograph) which measures to 1/100th second. Another module, in addition to the usual time and date readout, displays a pre-programmed message of up to four five-letter words. Custom modules with special commercial messages or slogans are available.

A wrist watch that's also a nine-function calculator is the third new type in the Hughes line. The solid-state electronic module, which measures only 1.4 by 1.25 inches, features an eight-digit LED display for both calculator and watch functions. The keys of its standard calculator keyboard can be pressed with a pencil point. Hughes does not market a watch to consumers, but is the largest producer of modules for watch manufacturers.

Hughes needs systems-level engineers: Sonar Systems -- design and develop surface and subsurface ASW tactical and surveillance sonar systems for Undersea Systems Laboratory....Special Projects -- engineering analysis of foreign air defense communications, command and control systems. Evaluation of C<sup>3</sup> networks and system performance evaluation. Requirements: BS or higher degree, U.S. citizenship. Please send resume to: Engineering Employment, Hughes Aircraft Company, P.O. Box 3310, Fullerton, CA 92634. An equal opportunity employer.

The location of enemy artillery can be pinpointed in seconds with the U.S. Army's new AN/TPQ-37 artillery locating radar. Its three-dimensional antenna scans the horizons with a pencil-shaped beam which moves so fast it forms an electronic barrier that can detect incoming projectiles as they rise above the horizon. These are tracked and their trajectories are back-plotted to locate the firing weapons, often before the first shell hits the ground. A contract for further development and for limited production of 10 ALRs has been awarded to Hughes.

The ALR can be deployed quickly and set up in 30 minutes. It has two main units: an antenna trailer towed by a 5-ton truck which carries the transmitter, receiver, and generator, and an operations unit housed in a standard S-280 shelter mounted on a 2½-ton truck. The shelter has room for two operators and a supervisor, although one man can do the job if necessary.

*Creating a new world with electronics*

**HUGHES**

HUGHES AIRCRAFT COMPANY

## Electronics review

inches, and the pin fell to the Martian surface. Viking's television cameras later showed the pin.

**Low power.** Another problem caused the lander's ultrahigh-frequency transmitter, which sends TV signals to the Mars orbiter for subsequent retransmission to earth to transmit with only 1 watt of power instead of the planned 30 watts. Because of this weakness, it took longer for the orbiter to acquire the signal, cutting the total time available for transmitting to earth. But after about three days, the transmitter began to correct itself. JPL engineers say this is evidently another "one of those anomalies" that happen in space.

The last of the "glitches" bothering the Viking craft, still uncorrected as of last week, is an inoperative seismometer. A locking mechanism that caged the instrument during the 11-month space journey and landing, refused to let go, even after repeated commands from flight directors at JPL. Some engineers speculate that the defect was caused by a wiring or electrical failure. □

## Careers

### EEs wanted: \$50 reward

As demand in semiconductors and minicomputers picks up, so does the demand for experienced engineers and programmers. But they're in short supply wherever their would-be employers are heavily concentrated—Silicon Valley and Orange County in California, as well as Boston.

As an incentive, several manufacturers have begun offering bounties to employees who bring in these scarce people. Among them, Fairchild Camera & Instrument Corp. is giving its employees "Fairchild Needs You" T-shirts and buttons to wear and is promising them clocks, digital watches and electronic games, in addition to a \$50 cash award for each engineer hired.

Doug Cooper, director of corporate staffing at the Mountain

View, Calif. firm, says the company is looking for 100 engineers because of a "general upturn in business." Design and process engineers are needed, as well as those experienced in bipolar, MOS and linear technologies. Warns Cooper: "We are going to see a critical shortage of experienced engineers in the industry."

Similarly, Bob Lo Presto, industrial relations vice president at American Microsystems Inc. in Santa Clara, Calif., says, "The industry is turning on again, and there aren't enough experienced people to go around." AMI is looking for 35 to 40 wafer-fabrication, MOS-design, production and other types of engineers and is "having to recruit in other areas" of the U.S.—as in fact is Fairchild. "It's hard to get a person from down the street to come here," without offering higher salaries, notes Lo Presto. Consequently, AMI has decided to reward employees with \$100 per referral next month and \$50 thereafter.

Further south in Orange County, General Automation Inc. in Anaheim is offering employees \$100 per computer programmer brought in, with emphasis on those with solid experience in industrial automation and systems work.

Meanwhile, Data General Corp. in Southboro, Mass, is finding it "a tight market" for people who are knowledgeable in the advanced state of the art. These are either coming out of school and in great demand or getting on-the-job experience and thus already employed, notes a Data General spokesman. However, Digital Equipment Corp. in Maynard, Mass., although also hiring, is encountering no problems in finding specialists in data communications input/output systems, computer-aided design, microprogramed-logic design, and memory-test-equipment design, as well as assorted programmers.

Still other sectors with a heavy grouping of aerospace electronics firms seemingly are faced with an oversupply of engineers, though some hiring continues of highly experienced engineers in specific disciplines. □

## For high-density CMOS/LSI circuits

Call Hughes  
(714) 548-0671

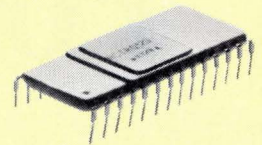

**1,021-channel Digital Frequency Synthesizer.** 5V supply, 5 MHz input. (HCTR 0320)

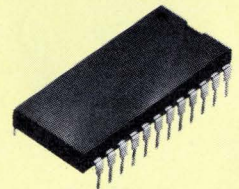

**Decade Counter/Latch/Decoder/Driver.** Up/down, 2 MHz, 5V operation, 7-segment output (HCTR 0200)  
**4 Decade Counter.** Up/down, 2 MHz, BCD outputs (HCTR 4010)

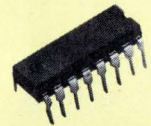

**4-Decade Counter.** 1 MHz, BCD outputs. (HCTR 6010)

**Custom MOS designs.** Use our experience in MOS/LSI circuits to meet unusual requirements like wide supply variations, high speed, ultra low power, differential amplifier input, RC oscillator and crystal oscillator. (Ask for custom MOS brochure).

Call number above or write to 500 Superior Ave., Newport Beach, CA 92663.



# HUGHES

HUGHES AIRCRAFT COMPANY

Solid State Products Division

# We've doubled our high voltage Power Transistor line.

## Read what's in it for you.

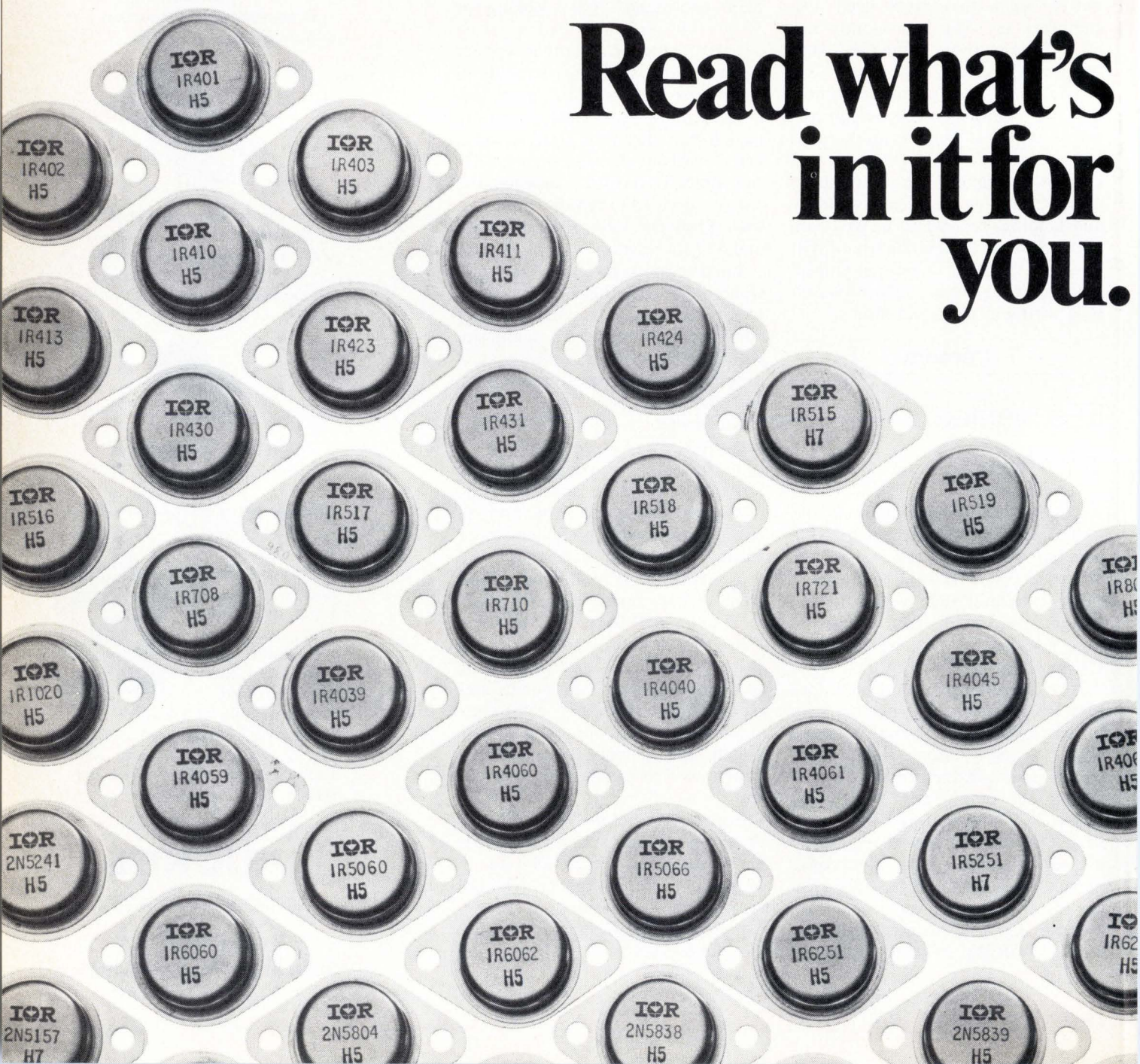

Our new, expanded line offers a lot more types than we could show here. But that isn't important to you. What is important is that now you can probably get a better device than you are now using, for these reasons.

All of the top power transistor companies make pretty good high voltage devices with low sats, broad operating areas, low switching losses. IR gives you that, and more.

For example, we use hard-glass passivation for our chips. That gives our devices longer life than those using organic passivating materials. It also gives a high-temperature stability that you can see in Figure 1, but may never see for other devices. It costs us more to apply. But it is far better for you in the long run.

We build and rate our devices to operate reliably and continuously at maximum rated junction temperatures. Other brands which come up short in high-temperature stability may require temperature derating. Check the performance of the ones you use.

Because we've specialized in "power" semiconductors for more than 28 years, we know the

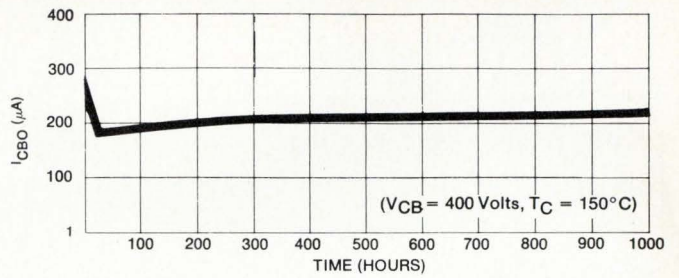

FIGURE 1 Typical High Temperature Reverse Bias Characteristics Vs. Time

importance of reliability testing. In addition to testing the 11 basic parameters of every device, we perform 100% tests on a curve tracer to make sure each part has a sharp high-voltage characteristic.

And there are other demands on power devices we've learned to handle over the years. Like mounting chips to the substrate so they stay there through years of temperature cycling. And making connections between the chip and case that last. Little things? No. They loom large when things go wrong on other devices.

In the case of chips to package yourself, you'll get a completely finished, fully protected and tested transistor for more flexibility in design and higher yields in your end product.

We offer the most popular types for the applications listed, so get our "Power Transistor Application Guide". Check it for our equivalents to the types you're using now. When you find them, you've found the way to add more stability and longer life to your product without adding to your costs.

That's what's in it for you!

Contact your local IR salesman, rep or distributor, or write to: International Rectifier, 233 Kansas Street, El Segundo, CA 90245. Call (213) 322-3331.

Our "Power Transistor Application Guide" gives the part numbers of types available for these applications. Get yours today.

- Switching Power Supplies ..... 64 Types
- High Voltage Linear Regulators .... 30 Types
- Auto Ignition Systems ..... 22 Types
- Ultrasonic Power Generators ..... 13 Types
- Vertical Deflection ..... 17 Types
- Horizontal Deflection ..... 23 Types
- Motor Drives ..... 32 Types
- High Frequency Lighting ..... 11 Types



# International Rectifier

... the innovative semiconductor people



Circle 45 on reader service card

# Now There's A Better Choice

10 millivolt sensitivity, AGC inputs, bright LED displays, automatic ranging . . .

## DATA TECH

### DIGITAL FREQUENCY COUNTERS

Model 111 . . . . . 120 MHz . . . . . 7 Digit  
 Model 113 . . . . . 200 MHz . . . . . 8 Digit  
 Model 115 . . . . . 520 MHz . . . . . 8 Digit  
 Model 117 . . . . . 560 MHz . . . . . 9 Digit

Standard features include: Overload protection • Burst operation • Serial BCD • Options include: Battery operation • .01 Hz resolution in 1 sec. • BCD or IEEE bus • Much more.

Priced from **\$350**

Measure frequency, single and multiple period, single and multiple ratio, single and dual channel time interval and t.i. average, and totalize . . .

## DATA TECH

### UNIVERSAL COUNTER TIMERS

Model 101 . . . . . 50 MHz . . . . . 6 Digit  
 Model 103 . . . . . 50 MHz . . . . . 7 Digit  
 Model 105 . . . . . 200 MHz . . . . . 8 Digit

Standard features include: 10 mV sensitivity • Overload protected to 250V rms • Variable DC offset • Full complement of triggering controls including scope monitors • 100 psi TI average resolution • Auto bandwidth reduction on period • Contact or pulse measurement operation including fixed or variable delay • RFI shielded case •  $\pm 3 \times 10^{-7}$  month time base • BCD output • Many options.

Priced from **\$675**

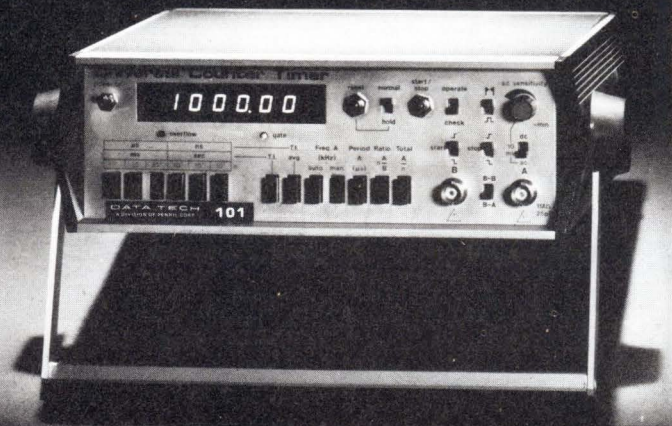
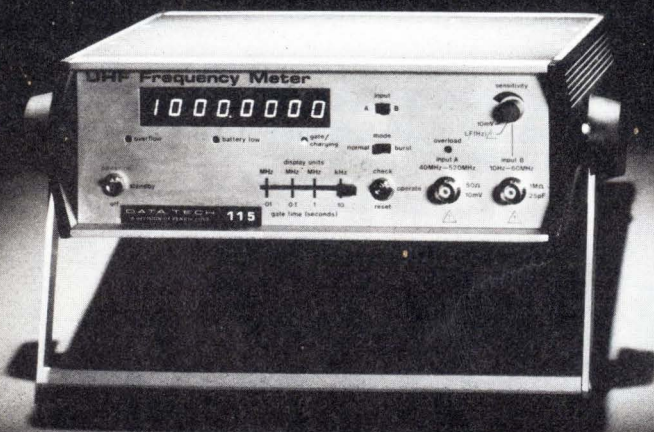



Completely automatic AM and FM modulation measurements to better than 3% accuracy.

## DATA TECH AUTOMATIC MODULATION METER

Model 209 . . . . . 1.5 GHz Frequency Range

Standard features include: Eight FM and six AM ranges • Automatically adjusts input level • One-second automatic operation • Audio filter • Up to 100 KHz positive or negative peak FM deviation • Up to 100% AM modulation depth • Selection of peak or trough on AM measurements • I.F. and A.F. outputs • Compact and lightweight • Rugged metal case • Battery option and much more.

Priced from **\$1225**

**Before you decide on another counter . . .  
get the full details on this all new family from**

## DATA TECH

*Data Tech (formerly Data Technology) introduces an all new family of frequency counters and universal counter/timers, plus an automatic modulation meter utilizing an entirely new concept in modulation measurement.*

*Now you have a better choice. Data Tech has a counter for every need. LSI technology significantly reduces the number of components so prices are remarkably low — and reliability is remarkably high! Each counter carries a two year full warranty.*

*Every conceivable function has been included in these precision instruments. All counters have a  $\pm 3 \times 10^{-7}$ /mo. crystal. Optional oven crystals, including  $\pm 3 \times 10^{-9}$ /day and  $\pm 1.5 \times 10^{-9}$ /mo., are available. All feature a rugged metal, RFI shielded case, and are immediately available from stock.*

*Before you decide on your next counter, get the full story from Data Tech. Circle the appropriate number for literature, or call for a demonstration.*



Hand-held  
Multimeters



Strip Chart Recorders

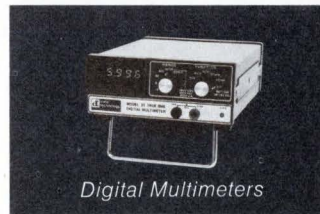

Digital Multimeters



Digital Panel Meters



# DATA TECH

A Company to Count on

**DATA TECH**  
A DIVISION OF PENRIL CORP.

2700 Fairview, Santa Ana, CA 92704  
Phone 714-546-7160 • TWX 910-595-1570

Circle 47 on reader service card

# Looking at price? Then look to the future... With glass TAX capacitors from ITT Components Group

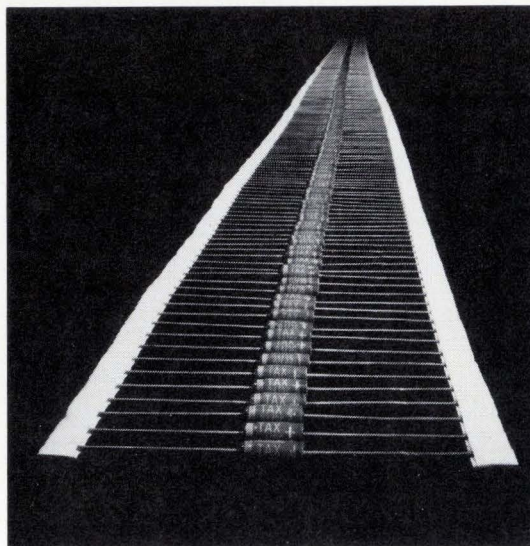

Today is the time to replace the Sprague 150D or the Kemet T110 you're using now with a compatible solid tantalum axial leaded capacitor available at a competitive price. Look into glass encapsulated, hermetically sealed TAX capacitors from ITT Components Group.

Glass . . . it's the look of the future. Your better buy because glass tantalums can be produced by super automation processes and require no insulating sleeves. The simple manufacturing process will make glass — as time goes by — the increasingly economical alternative to metal-canned, axial leaded tantalum capacitors. And with future assurance of good delivery levels.

The TAX series is packaged to run

right off its reel and into your operation. Automatically. And if you are using Kemet's T310 you will want to compare the reliability of epoxy against our **better priced better option — glass**. Each unit is 100% tested for hermeticity and to all data sheet parameters because sample testing just isn't good enough for ITT Components.

Look to the future today by checking out glass tantalum capacitors. For technical specifications and free samples of the TAX, write to George Kase at ITT Components Group, 1551 Osgood St., No. Andover, MA 01845. Or call him at (617) 688-1881. Tell him you want to look into our better alternative!

## Ratings

Capacitance: .....	0.1 to 47 $\mu$ F
Tolerance Range: .....	$\pm 20\% \pm 10\%$
Voltage: .....	6.0 to 35 volts DC (50 volts on request)
Temperature Range: .....	$-80^{\circ}$ C to $+125^{\circ}$ C.

We're listed in sections 1500 and 4500 in your 1976-7 EEM catalog.

When you need capacitors, our better alternative will be your first choice.

**ITT**  
Components

## **CB makers seek new rules from FCC for 40-channel service . . .**

The long-awaited expansion of class D citizens' radio service from 23 to 40 channels, effective Jan. 1, 1977, left CB radio makers with multiple questions for the Federal Communications Commission. The FCC says it expects that industry queries on type-acceptance requirements, occupied bandwidth and modulation, and test-procedure **rules will be answered in a bulletin to be issued not later than mid-August** by the Office of Chief Engineer, headed by Raymond Spence.

On the marketing side, industry officials privately concede there **probably will be significant discounting of unsold 23-channel transceivers**. Stressing that its ruling is only an interim measure, the FCC says its Office of Plans and Policy and the Personal Use Radio Advisory Committee is still considering alternative spectrums at 220 and 900 megahertz for CB use. Manufacturers and the Electronic Industries Association are pushing for an additional Class E service in the 220-MHz region, while the National Association of Broadcasters opposes any expansion—including the present one—on grounds that it interferes with TV signals.

## **. . . but new units must cut TV interference, carry serial numbers**

New 40-channel CB transceivers, the FCC has ruled, must raise harmonic radiation suppression to 60 decibels from the present level of 49 dB to cope with TV interference. "Should additional suppression be shown necessary," the FCC ruling adds, licensees will "be required to insert low-pass filters on their transmitters." **The new channels will be between 27.235 and 27.405 kilohertz, the FCC says, with the 10-kHz spacing between channels unchanged from the present service.** Similarly, all channels will be available for shared a-m/single side-band use, despite manufacturers' requests for allocation of several new channels for SSB use only.

The FCC also has ordered that receivers made after Jan. 1, 1978, must limit spurious rf energy at the antenna terminals to 0.2 nanowatt, and hold chassis radiation to 15 microvolts per meter at a distance of 1 meter from the receiver. Manufacturers complain that the 0.2-nW limit is unnecessarily severe and the chassis-radiation measurement will be difficult to achieve. **The FCC says that the rigid requirements are necessary to prevent interference with land-mobile telephone systems that are also used on highways.** Sets made after Jan. 1, 1977, however, will only be required to meet limits of 2 nW at the antenna, and 5  $\mu\text{V}/\text{m}$  radiation measured 3 m from the chassis.

**Other requirements laid down by FCC:** deletion of 27.085 MHz as a calling-only channel, inclusion of Part 95 of FCC rules and forms 505 and 55-B with each new transmitter sold, prohibition of the use of add-on devices to increase the range of existing transmitters, and the engraving of a serial number in each CB chassis to aid in identifying stolen equipment.

## **Addenda**

**Watch for Aeronutronic Ford to be named winner in the competition with TRW for the Intelsat V,** the International Telecommunications Satellite Organization's next generation of communications satellites . . . **National Science Foundation director Guyford Stever has been nominated by President Ford,** as expected, to head the new Office of Science and Technology Policy, which replaces the science advisor's office eliminated under President Nixon.

### Color-TV imports: confusing jurisdiction with justice

Reformation of the Federal bureaucratic system promises to become a major issue in the 1976 national election. It should be. The bureaucracy is fat, inefficient, and represents an enormous drain on Federal funds that could be spent more productively elsewhere.

In addition, the existing bureaucracy produces unbelievable delays in the administration of justice for taxpayers while agencies wrangle over jurisdictional issues. One of the most recent examples involves the pending charges, brought before the International Trade Commission by GTE Sylvania and its Philco subsidiary, that color-television receivers are being dumped on the American market by Japanese manufacturers acting in conspiracy [*Electronics*, July 22, p. 42]. Consideration of the issues is hanging fire while the ITC and the Treasury department try to resolve who's in charge.

The ITC-Treasury flap is characteristic of the bureaucracy's confusion of jurisdictional issues and the job of dispensing justice. In this case it is America's color-television producers who are the losers. They are no longer amused by the line that Washington's bureaucrats refuse to look out the window when they get up in the morning because it would leave them with nothing to do when they get to the office.

Color television is the last major home-entertainment electronics market where domestic production is still a significant factor. But the number of manufacturers is steadily declining. Before makers of monochrome sets either shut down or moved offshore, the U.S. had 28 TV manufacturers of all types in 1960. By 1969 that number had halved. Last year it was down to 10, and three of these are foreign-owned. And most of these 10 are increasing their investments in offshore color production facilities.

It is time for Treasury to realize that domestic color-TV production is ready to flee America just like monochrome TV, home and auto radios, and high-fidelity components. Certainly it has the data in its own files to document those losses to the domestic economy.

If Treasury Secretary William Simon believes the policy of the Ford Administration is to maintain good relations with Japan at the expense of one more segment of American industry, then he should say so. If not, Simon should notify his staff that they should stop busying themselves with time-consuming jurisdictional disputes that do no more than protect their own jobs. Their first priority must be to get on with the work of adjudicating swiftly the issues raised by the taxpayers who pay them.

### Jedec: a new approach to microelectronics standards

Since its formation in 1958, the Joint Electron Device Engineering Council has worked successfully with the components manufacturers that make up its membership to register more than 15,000 discrete semiconductor devices. But about a decade ago when Jedec, a joint effort of the Electronic Industries Association and the National Electrical Manufacturers Association, moved to develop standards for integrated circuits, manufacturers stayed away in droves.

Happily, there are signs that is changing. One Jedec committee has developed a standard for B-series complementary metal-oxide semiconductors. From C-MOS the council proceeded to develop a flexible, two-level approach for microelectronics that permits manufacturers to list devices with Jedec using a 12-digit code and data from their own house numbering systems. Optionally, a manufacturer can also register devices to a precisely defined industry standard.

Now Jedec faces an even greater challenge as it tries to make 16,384-bit random-access memories functionally interchangeable. That

effort gets under way on Aug. 10 at Santa Clara, Calif., with the meeting of eight major manufacturers at the Marriott Hotel. It won't be an easy task for American Microsystems Inc.'s Joseph McDowell, who chairs Jedec's JC-42 committee on integrated-circuit memories. But the list of registrants is impressive. In addition to AMI, they include Advanced Micro Devices, Fairchild Camera, Intel, Mostek, Motorola, National Semiconductor, and Texas Instruments. "Assuming we all don't get into a fist fight," McDowell laughs, there will be other meetings of JC 42 downstream.

Why the change? Customer pressure is part of it, says Jedec staffer Jack Hessman. And Jedec is taking a more flexible approach to the problems of standards—one that it likes to call "harmonization of specifications." That European expression may prove too big a mouthful for Americans to swallow, yet it represents a significant advance toward the development of interchangeable and less costly parts that can only contribute to the further expansion of electronics into new markets. —Ray Connolly

# They stay out front with Motorola's M6800 Family

## TRW

Programmable terminals in TRW's new 2001 POS system allow each store its own unique personality. They're interactive. They lead operators step-by-step through transactions, authorize credit, compute difficult calculations, and give customer receipts with word descriptions. They also provide information for management reports. The 2001 POS system relies on Motorola's M6800.

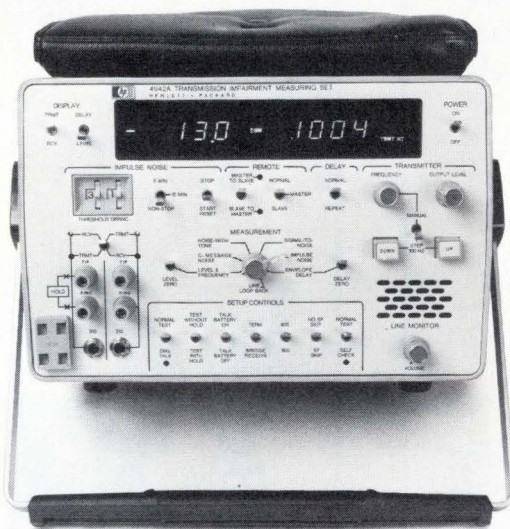
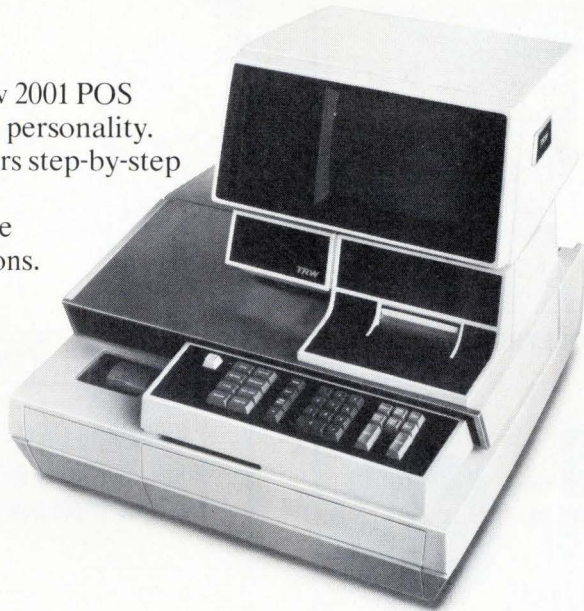

## HEWLETT-PACKARD

Improvement in analog parameter measurement of voice bandwidth data circuits is the object of Hewlett-Packard's 4942A Transmission Impairment Measuring Set. It has automatic self-check, master/slave control, automatic system capability, and it's portable. Microprocessing gave the system minimum power consumption and size. M6800 gave it the required analog hardware interface and desired master/slave control.

## RUSCO

Rusco Electronic Systems' CARDENTRY 500 is far more than just a site-access security system for more than 20,000 separate identities. It's programmable, so lost cards are ruled out at the touch of a button. It also monitors alarm systems, reports personnel in-out status, automatically locks and unlocks locations, manages copy machine usage, and more. Microprocessing is by the M6800 Family.

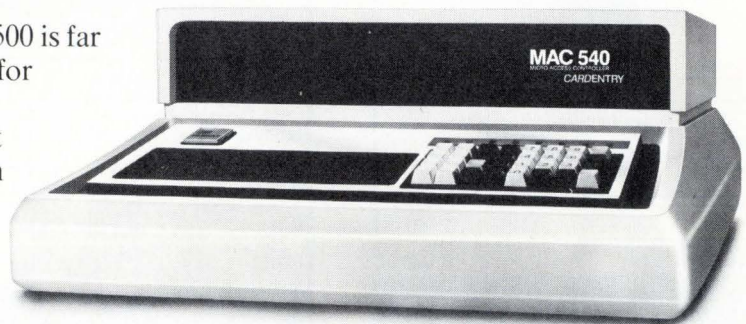

Motorola Semiconductor Products Inc. P.O. Box 20912, Phoenix, AZ 85036



# MOTOROLA Semiconductors

—and you thought we were just a production house

# ANOTHER WINNER

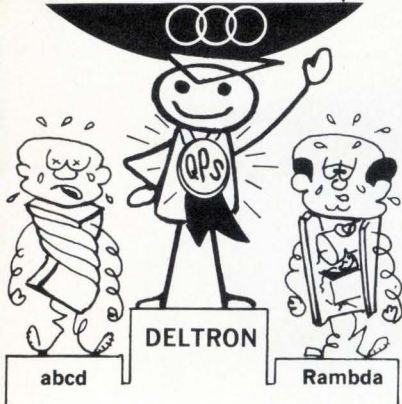

**QPS** series  
**Power Supplies**

**\$21<sup>50</sup>**

One year warranty.  
From stock.  
U.L. recognition.  
Barrier block interface.

Socketed I.C.  
regulator.  
Crowbar  
accessory.

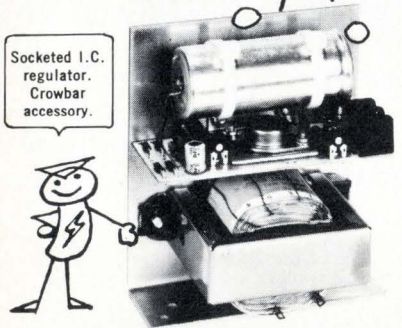

MODEL	QPS-1	QPS-2	QPS-3
RATINGS Volts/Amps	5/3 or 6/2.5	12/1.5 or 15/1.2	24/1
QTY.	1	100	250
PRICE	\$24.00	\$22.50	\$21.50

**Deltron inc.**

Wissahickon Avenue  
North Wales, PA 19454

Tel: 215/699-9261 Twx: 510/661-8061

AC-10

# POWER SUPPLY MAGIC



There's no trick! Get a full house everytime with Deltron's dual and triple power supplies.

U.L. recognized.  
One year warranty.

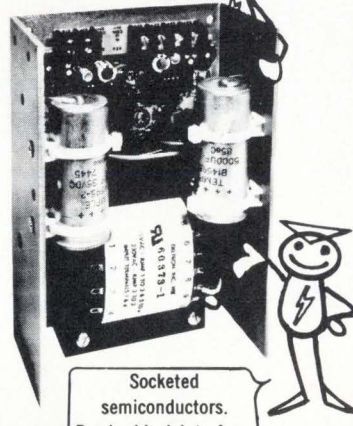

Socketed  
semiconductors.  
Barrier block interface.

MODEL	RATINGS volts/amps	PRICE		
		1	100	250
QD12/15-0.6	±12 to ±15/0.6	\$42	\$36	\$35
QD12/15-1.7	±12 to ±15/1.7	\$62	\$54	\$49
QD12/15-3.0	±12 to ±15/3.0	\$79	\$67	\$64
QT-1	5/3.0	\$69	\$66	\$65
	±12 to ±15/0.5			
QT-2	5/6.0	\$89	\$82	\$79
	±12 to ±15/1.0			

**Deltron inc.**

Wissahickon Avenue  
North Wales, PA 19454

Tel: 215/699-9261 Twx: 510/661-8061

AC-12

# OPEN FRAME POWER SUPPLY ELECTION

## ★ DELTRON PLATFORM ★

- ★ Competitive Prices.
- ★ Stock Delivery.
- ★ 1 yr. Warranty.
- ★ "Real" Specs.
- ★ User Designed.
- ★ Lowest Temp. Derating.

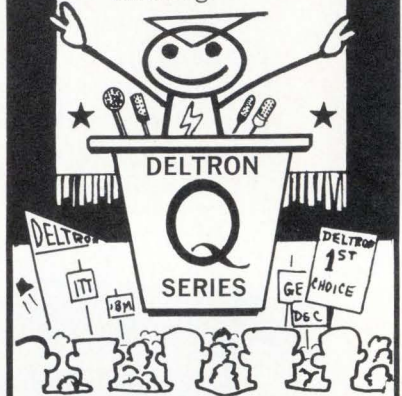

FROM THE "PRIMARY" ON...  
IT'S "Q" SERIES  
ALL THE WAY!

U. L. Recognition.  
Interchangeable with  
competitive units.

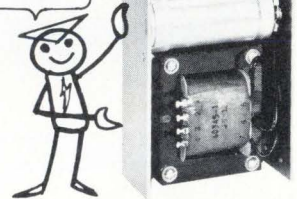

Size A Model No.	Size B Model No.	Size C Model No.	Size D Model No.	Size F Model No.
volts—amps	volts—amps	volts—amps	volts—amps	volts—amps
Q 5—3.0	Q 5—6.0	Q 5—9.0	Q 5—12.0	Q 5—18.0
Q 6—3.0	Q 6—6.0	Q 6—9.0	Q 6—12.0	Q 6—18.0
Q 12—1.7	Q 12—3.4	Q 12—5.7	Q 12—7.0	Q 12—10.8
Q 15—1.5	Q 15—3.0	Q 15—4.8	Q 15—6.3	Q 15—9.5
Q 18—1.3	Q 18—2.6	Q 18—4.0	Q 18—5.2	Q 18—7.8
Q 20—1.3	Q 20—2.6	Q 20—4.0	Q 20—5.2	Q 20—7.8
Q 24—1.2	Q 24—2.4	Q 24—3.3	Q 24—4.8	Q 24—7.2
Q 28—1.0	Q 28—2.0	Q 28—3.1	Q 28—4.2	Q 28—6.0
Dimen. 4 7/8 x 4 1/8	Dimen. 5 3/8 x 4 3/8 x 2 1/2	Dimen. 7 x 4 7/8 x 2 3/4	Dimen. 9 x 4 7/8 x 2 3/4	Dimen. 14 x 4 7/8 x 2 3/4
Price: 1—\$32. 100—\$26. 250—\$24.	Price: 1—\$54. 100—\$44. 250—\$41.	Price: 1—\$67. 100—\$54. 250—\$51.	Price: 1—\$87. 100—\$70. 250—\$66.	Price: 1—\$113. 100—\$91. 250—\$85.

**Deltron inc.**

Wissahickon Avenue  
North Wales, PA 19454

Tel: 215/699-9261 Twx: 510/661-8061

AC-13

## Matsushita's MOS image sensor cancels spurious signals to optimize pictures

The matrix-type MOS image sensor is likely to be popularized as the result of a modification of this area device to cancel spurious signal components. Without these spurious signals, its video signals faithfully reproduce the original images. The device, developed by Matsushita Electronic Corp. in Japan, cleans up the picture because it is built in a line-correlation configuration.

The device, similar to sensors built by others, is available with a matrix of 64 by 64 elements on a chip 5 millimeters square. A larger device, tentatively planned to have 250 by 250 elements, is also being developed by the company, which is jointly owned by Matsushita Electric Industrial Co. and Philips Gloeilampenfabrieken of the Netherlands. That chip will probably be 10 mm square. The number of elements and resolution are at present limited by practical chip size and cost.

**Canceling.** Matsushita engineers say their device has a true signal-to-noise ratio of 40 decibels or more because it substantially eliminates two spurious signals that tend to plague these image sensors—the pseudo-image signal and dark current, which corresponds to the drain current when the device is not lit.

The sensor is free of blooming, which company engineers say is a grave disadvantage of competitive sensors made of charge-coupled devices. The blue response is also superior to that of CCDs, most of which are covered with a thick layer of polysilicon that somewhat degrades blue response.

Drive and peripheral circuits are simple. What's more, the 64-by-64 bit device with low-power shift registers for scanning dissipates only 15 milliwatts, which minimizes temperature, thereby keeping the drain-leakage current low.

Matsushita sources say that CCDs often require eight mask-alignment

operations, which makes for low yield, while MOS devices require only five or six alignments. The one disadvantage of MOS devices is the relatively large area per element.

**Scanning.** Basically, the sources of the p-channel MOS transistor elements making up the matrix behave as photodiodes. All the elements in a single horizontal row are selected by a signal applied to the gates of all the elements in that row. To select an individual element in a row, a signal is applied to the gate of a MOS switch inserted in the line connecting

the drains of the elements in the column and the sense amplifier. In the horizontal scan, the MOS switches are selected in order. In the vertical scan, the rows are selected in order.

To cancel spurious signal components, the configuration was modified by connecting alternate elements in each column to two separate output lines and connecting each pair of output lines to two MOS switching transistors. One transistor is connected to the inverting input of an operational amplifier, and the other to the noninverting input. □

### Around the world

#### Satellite terminal built for remote areas

West Germany's Siemens AG is offering an inexpensive mobile ground terminal that can be installed in remote areas to pick up signals from communications satellites. The terminal accommodates both color and monochrome television transmissions, as well as radio. Only 4.5 meters in diameter, the terminal's antenna is small enough for easy transport to remote locations. Since the antenna dish comes in four sections, the whole station can be moved by truck or plane almost anywhere. The 500-kilogram terminal can be installed in hours, and its wide beam enables the antenna to do without a tracking system.

The terminal, developed with the support of West Germany's Ministry for Research and Technology, is intended primarily for reception of radio and TV programs via the two Symphonie Franco-German experimental communications satellites. The first terminal is already being tested near Kigali, capital of the central African republic of Rwanda.

The antenna system consists of a far-field cassegrain antenna with the main reflector 4.5 meters in diameter and a hyperbolic subreflector 61 centimeters in diameter. The antenna-feed system is a corrugated horn offering optimum symmetry and broadband characteristics that allow it to be operated simultaneously in the 4-gigahertz reception band and the 6-GHz transmission band.

#### Visual device enables mutes to communicate

An electronic means of visual communications for people incapable of speech is being produced and marketed by Diode B. V., a subsidiary of International Rectifier Corp. in Utrecht, the Netherlands. The portable battery-operated system, the Elkomi 2, has a small display to show typed text and a keyboard containing 40 keys.

The speaker and listener sit opposite one another so that the single nine-character display is simultaneously visible to both by means of a triangular plexiglass prism over the screen. As the keys are pressed, characters are projected onto the display, which shows enough of most words for readability as the letters shift from right to left. The 5-by-7-dot display, made up of light-emitting diodes, operates at the rate of 50 cycles per second; illumination time is 2.4 milliseconds. The device contains a standard 2,048-bit memory.

# The Only COMPLETE Microprogram Controller

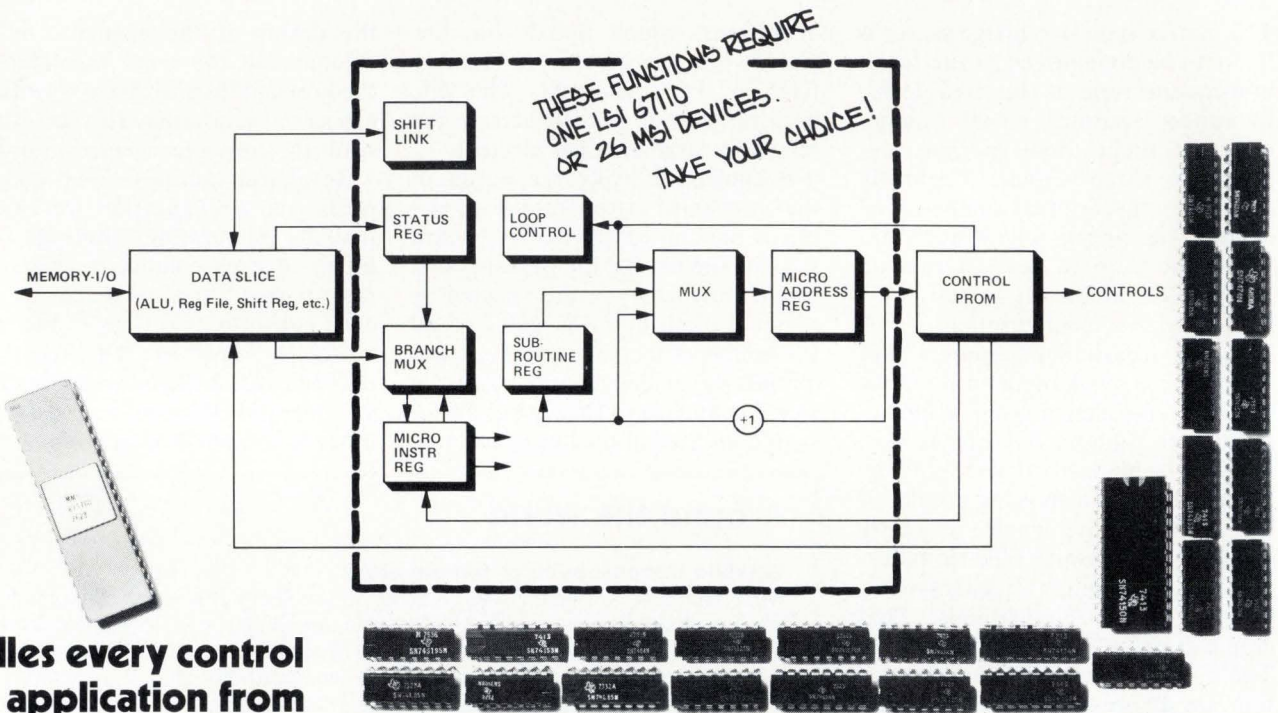

Handles every control application from discs to CPUs.

And replaces 26 or more MSI devices.

## Applications

CPU  
Process Control  
Disc Control  
High Speed Printer Control  
CRT Controller  
Signal Processing Control

## Features

- Works with any bit slice microprocessor such as MMI 6701, 2901, 3002.
- Works as a stand alone non-arithmetic controller
- Directly addresses 512 words of microprogram storage
- On-chip five bit loop counter for program looping routines
- Data shift linkage for arithmetic and logic shifting with 4 bit slices
- Microsubroutine and four way branch capabilities
- Very High Speed — 33 MHz

For more information about this revolutionary microprogram controller and about other members of our growing family of LSI logic devices that will eventually replace all MSI logic, call, TWX or write:

In the United States,  
Ed Barnett or John Birkner.  
In Europe, Bernd Kruse

**United States**  
Monolithic Memories, Inc.  
1165 East Arques Avenue  
Sunnyvale, CA 94086  
Tel: (408) 739-3535  
TWX: 910-339-9229

**Europe**  
Monolithic Memories, GmbH  
8000 Munich 80  
Mauerkircherstr. 4  
West Germany  
Tel: (089) 982601, 02, 03, 04  
Telex: (841) 524385

**Far East**  
MMI Japan KK  
Parkside-Flat Bldg  
4-2-2, Sendagaya Shibuya-Ku  
Tokyo 151, Japan  
Tel: (3) 403-9061  
Telex: (781) 26364

DEVICE	TEMPERATURE	100 QUANTITY PRICE
67110J	Commerical	\$25.00
57110D	Military	\$55.00

# Monolithic Memories



# International newsletter\_\_\_\_\_

## **Microwave link to span 83 miles from West Berlin**

AEG-Telefunken has won a contract from the West German Post Office to build a line-of-sight microwave link to hop the 83 miles between West Berlin and Gartow, on the West German border. **The link, to be operational by mid-1979, necessitates towers as high as 340 meters**—40 meters higher than the Eiffel Tower—to clear the earth's curvature without repeaters. For political reasons, repeaters won't be installed in the intervening East German territory. Since World War II, tropospheric scattering techniques at super-high frequency has been the sole means of microwave communications between West Berlin and West Germany.

## **BBC research makes blemish remover for CCD TV cameras**

Although semiconductor makers must solve many problems with charge-coupled-device imaging arrays before they can produce a color-television camera of studio quality, the British Broadcasting Corp. research department already has wiped out one problem. The researchers have rid pictures of white spots caused by mysterious dark currents in individual CCD cells. The solution: log the location of misbehaving cells into an electrically erasable read-only memory so that **interpolation circuitry can block out the failed cell's output**. To get the picture value, the cell's output is interpolated from the two adjoining ones. Although it is not perfect—it cannot handle a cluster of failed cells—ROMs could be built into CCD arrays so that each array could be corrected for life.

## **Brightness doubled in Hitachi TV set by mask focusing**

A color-television tube nearly twice as bright as its predecessors will appear in sets marketed late this year or early next year by Hitachi Ltd. The brightness gain, which comes from pushing almost double the usual number of electrons through the tube's shadow mask to the phosphor-dot screen, is achieved by applying a voltage difference between the mask and screen. What's more, a high 24-kilovolt potential on the electron guns, which have two unipotential focus main lenses in cascade, makes possible excellent focusing with the three guns arranged in the 29-millimeter neck. A lower 12-kV potential on the shadow mask still provides enough scan magnification so that the tube, which has a 110° deflection angle, can be scanned with about the same power as a conventional 100° tube.

## **IBM expects OK for switched net throughout France**

IBM France expects the Postes et Télécommunications agency to allow it to establish a countrywide transit switching network for automatic switching of its IBM 3750 private branch exchanges. PTT approval, expected in September, will allow IBM to interconnect by high-capacity leased lines its central Paris offices, its manufacturing plant in Montpellier, its research and development laboratory in La Gaude, and other company installations.

The company hopes to begin integrating its switching system in December, and the network is scheduled for completion in 1978. The network will provide the installations with the same facilities as the 3750 offers in-house, including multiparty conversations, paging services, and other functions. **More important, it could pave the way for other companies to implement similar networks for their installations in France.**

### Inductors avoid magnetic coupling on thin films

A family of tiny fixed inductors for reflow-soldering to film circuits is being built by Siemens AG with new ferrite packages that avoid magnetic coupling with adjacent components—often a critical problem in closely packed film circuits. **The ferrite material, called Siferit, has specific resistance as high as  $10^9$  ohm meters. The new component, the B78008, comes with inductance values from 0.1 to 470 microhenries at quality factors between 30 and 70.** Its package has an area of 4 by 3.2 millimeters and is 3.5 mm high. It provides a magnetically closed circuit with extremely low stray fields.

### Plessey plans CCD, magnetic-bubble, and holographic memories . . .

A broad-based assault on the high-technology-memory market is being mapped by Plessey Memories, which now is offering evaluation models of a 256,000-bit magnetic-bubble-memory system. Expected soon to become a commercial product, the memory consists of 16 16-kilobit dual in-line packages mounted on a printed-circuit board with interface circuitry. Likely to follow are 16-kilobit charge-coupled-device memories, even though not unusual current-leakage problems have delayed the buried-channel, three-phase metal-gate devices.

In development is an archival holographic-memory system employing a specially developed page composer and Kodak ultra-sensitive photographic film with a conventional laser-activated holographic system.

### . . . and CCD delay lines for filters and audio uses

Add Plessey Semiconductors to those manufacturers eyeing a market in charge-coupled-device delay lines for signal processing. This fall, Plessey plans to offer evaluation models of 256-bit and 340-bit analog devices aimed at radar and filter applications. These devices, with a maximum 5-megahertz frequency, are to be followed by a 512-bit delay line, also to be made at the Allen Clark Research Centre. Also in development for the consumer market is an inexpensive audio delay line with on-chip clock generation.

### Dutch cities turn to microprocessors to control traffic

Cities in the Netherlands are turning to automobile-traffic-control systems built around microprocessors. **The fifth Dutch city to install such a system is Eindhoven**, home of Philips, the system supplier. In addition to coordinating traffic control, the Eindhoven system displays recommended vehicle speeds at six intersections. One rather complex intersection requires constant modification of the control sequence because of numerous changes in traffic patterns. And even when communications between controllers fails, the controller at each intersection continues to operate autonomously.

### Hitachi shares its wire-bonding skill

Japan's Hitachi Ltd. has revealed to Motorola Semiconductor in the U.S. its technique of automated wire-bonding. This technology is being shared as part of the deal last November that grants Hitachi nonexclusive rights to produce the M-6800 microprocessor and joint development of higher- and lower-level microcomputer systems. **For the past two years, Hitachi has been using groups of as many as five wire bonders under the complete control of minicomputers.**

Circle 57 on reader service card →

# The Illustrated Guide to OEM Success.

digital



# Digital OEMs get the right power at the right price.

These are the Digital CPUs. The PDP-11s. And the PDP-8s. Price/performance packages designed to make sense and to help OEMs make money.

Digital offers two basic PDP-8s with six variations. And

eight PDP-11s. The PDP-8s virtually created the OEM computer market. They're the most successful minis ever. The PDP-11s have grown into the best conceived and best integrated 16-bit computer family in the world.

Together they span a range of computer power, price and applications niches unmatched by any line of computers under a single name.

But more than a remarkable line of machines, these comput-

## LSI-11

Digital's LSI-based 16-bit "mini on a board" brings PDP-11 Family performance to the low, low end. A high performance N-Channel MOS CPU, fully developed software tools, easy interfacing, and a long list of flexible features. For control and processing applications. Up to 32K words memory, 400+ instructions.

**\$990**

## PDP-11/03

The LSI-11 microcomputer packaged. Includes LSI-11 with 4K RAM or 4K core, power supply including switches, lights, and dual fan assembly, and standard rack-mountable enclosure. Easy-to-use front pop-panel leaves lights and switches attached and functional when removed.

**\$1,995**

## PDP-11/04

The basic OEM mini and smaller of the Twin Mini PDP-11/04 & 11/34 pair. Offers speed and economy, UNIBUS™ architecture, all 11-Family peripherals and software. Up to 28K words core or MOS memory. RT-11, RSX-11M, RSX-11S operating systems. More than 400 Instructions • Direct Memory Access • Vectored Automatic Priority Interrupt • Virtual Programmer's Console • ROM diagnostics.

**\$3,795**

## PDP-11/34 — A Mid-Range PDP-11

Just introduced. The other Twin Mini — totally compatible with the PDP-11/04. Flexible and expandable — up to 128K words core, MOS, or both. Powerful and speedy. System features include:

**\$9,290**

• Extended Instruction Set • Memory Management & Protection • Hardware Multiply/Divide • Floating Point Processor • Supports RSTS/E. All PDP-11/04 features.

## PDP-11/35

A powerful system computer for multiple-task applications, and an OEM favorite. Offers optional fast, low-cost Hardware Floating Point, Hardware Multiply/Divide, and advanced operating systems, RSTS/E, RSX-11D & M. Up to 124K words memory.

**\$10,995**

## PDP-11/45

The workhorse computer for demanding multi-task environments. Optimized for speed. 300 nanosecond CPU and your choice of mixable 300 nanosecond Bipolar, 495 nanosecond MOS, or 900 nanosecond core memory. Features include:

• Up to 124K words memory • Independent (single or double

precision) Floating Point Processor • Double operand instructions • Full PDP-11 instruction set • RSX-11D & M, RSTS/E operating systems.

**\$35,750**

## PDP-11T55

The Fortran Machine. Designed to accelerate Fortran-compiled tasks, recent Whetstone tests rank the 11T55 with mainframe machines at 4 times the price. For critical process control, lab experiments, simulation. Shottky logic, 3 million instructions per second, Bipolar memory, 400 hard-wired instructions. Dual-bus memory. FP 11-C Floating Point Processor — fastest in its class. Package includes CPU with 32K words bipolar or bipolar/core memory, 2 RKO5 disks and controller, LA36 DECWRITER II, cabinet, and more.

**\$42,000**

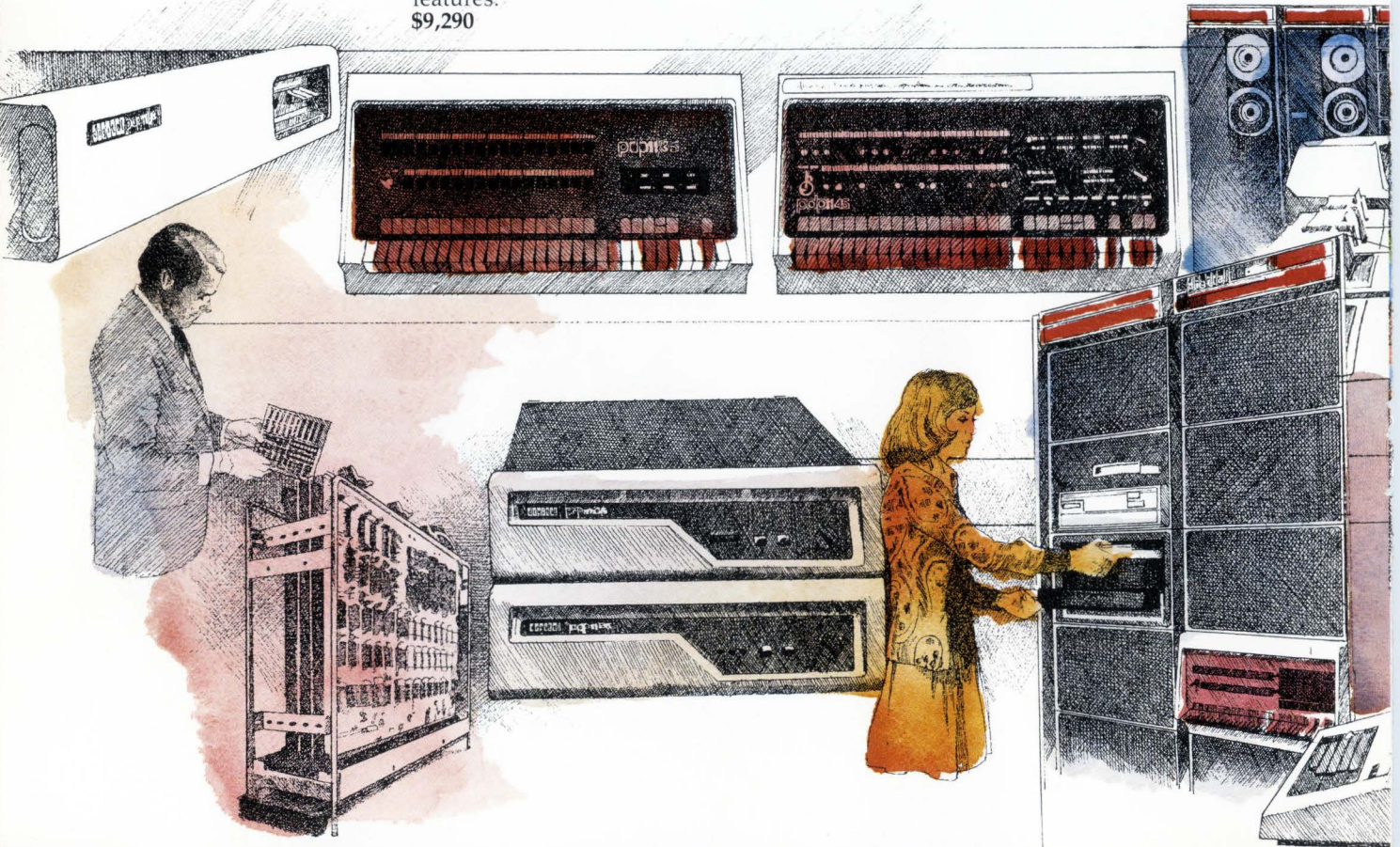

ers separately and together represent a remarkable business opportunity for OEMs of all descriptions. They've cut the cost of power for OEMs who buy in volume. They've cut the cost of change for OEMs whose

business has relied on tailored packages and expanding product lines. And perhaps best of all, they've cut the cost of selling for OEMs who have learned that building the Digital name into their product is one of the

fastest ways to win acceptance. Digital's CPUs. The hands-down choice of successful OEMs around the world, and why not? They're the ones that make the numbers come out right.

**PDP-11/70**

The 11/70, a medium-scale, multi-user, multi-function computing system. Digital OEMs get a high-performance thruput oriented system at a cost-effective price. With a 300 nanosecond CPU, cache memory, 32-bit data paths and integrated high-performance I/O channels. Integral memory management allows up to 2 million bytes core memory. Powerful operating systems include IAS—real-time, batch, and timesharing simultaneously, plus RSTS/E, RSX-11D & M.  
**\$60,000**

**The PDP-8 Family Kit 8/A**

Over 30,000 PDP-8s make the 12-bit 8-family the most successful minicomputer ever. Here it is in a 2-board module set for only \$1,350. Includes CPU module and 1 to 16K words ROM, PROM, RAM or Core memory.  
**\$985**  
**8/A 100**  
 Low cost. 4th generation design. Simplicity and reliability. Lots of software. Digital OEMs get all the PDP-8 features in a small semiconductor version that can handle up to 32K words RAM or ROM memory. Battery backup standard.  
**\$1,835**

**8/A-400/420**

Try this for a system: 8/A CPU with 1.5  $\mu$ sec cycle time, core memory, 8K to 32K words memory, and a

12-slot backplane. Then add low cost Digital peripherals like floppy and cartridge disks, CRTs and terminals. 20 slot 8/A-420 also available.  
**\$3,150**

**8/A-600/620**

If you need more speed, then you're in the right place. 1.2  $\mu$ sec cycle time processor—Digital's famous 8/E, in fact, with low-cost 8/A components and packaging.

Optional Hardware Multiply/Divide. Up to 32K words memory. 20 slot 8/A-620 also available.

**\$3,950**

**8/A-800/820/880**

The Super 8. Fast hardware floating point and parallel processors. 32K direct addressing. 64 new instructions. 20 slot 8/A-820 also available. MS-800 Desk configuration with optional VT-52. Package includes processors, dual floppy disks, 2 option boards, ROM-based diagnostics, and OS-8 operating system.

**\$6,150**

All hardware prices quoted are single quantity prices. Unit and dollar volume discounts are available. Quoted prices as of June 1, 1976, subject to change.

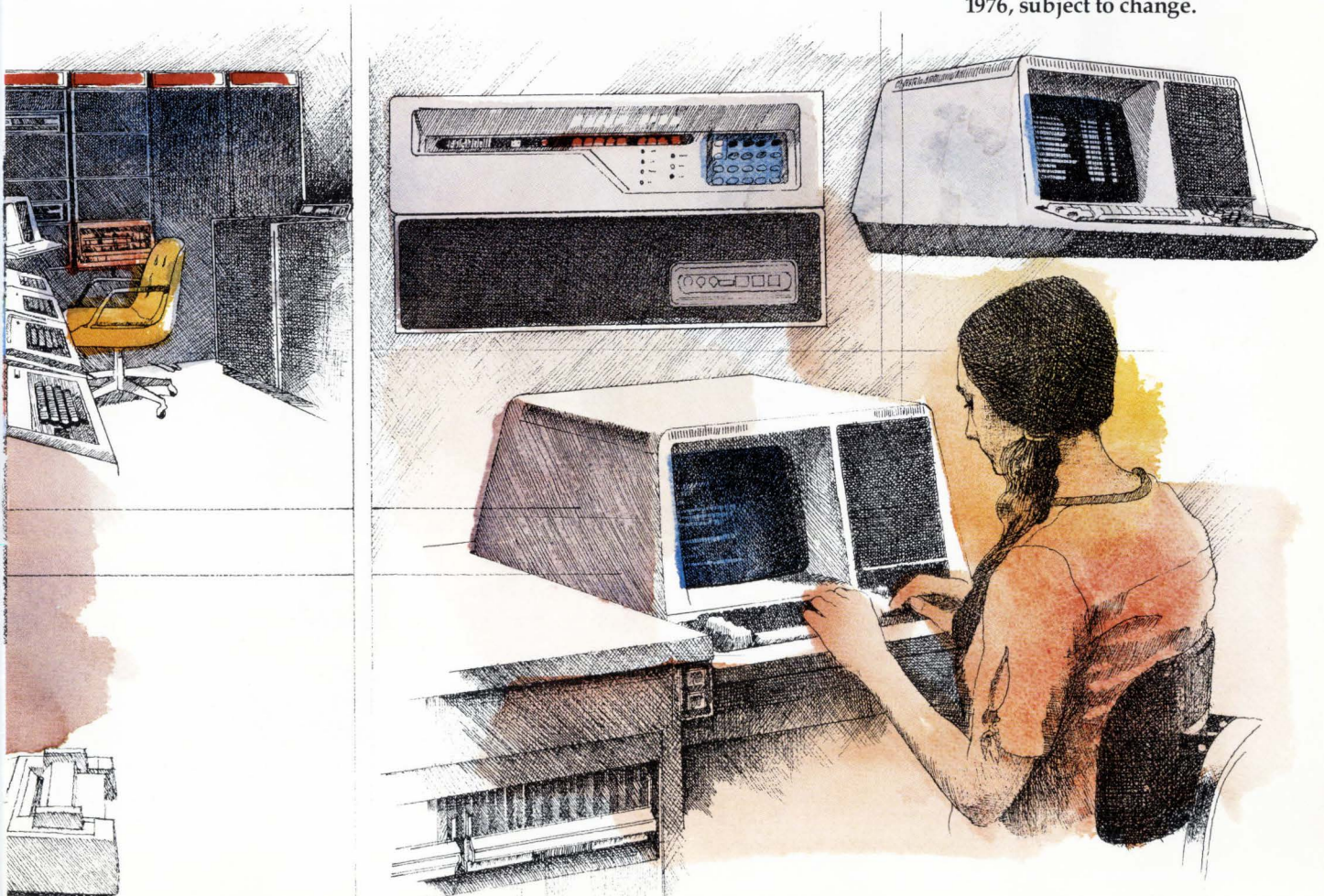

# Digital OEMs get systems that can grow and change.

The terminals and peripherals sold by Digital are made by Digital. Not just to guarantee design and manufacturing excellence. But also to guarantee the fit. It's the strength of a Digital system that all parts work, and

work together.

A Digital OEM has room to be creative. As today's big idea grows bigger, there are always Digital tools at hand that fit the need and fit the system.

A Digital OEM can make

his product or application grow in simple and controllable steps that minimize his financial risk. And he can make these changes without starting from scratch. Instead he adds on or upgrades in ways that preserve his invest-

## Terminals and Printers

**DECscopes VT50/VT52**  
The versatility, performance and reliability of a video terminal at teletypewriter prices. Up to 24 lines of characters. Simple to use and quiet. Office typewriter keyboard layout, three-key rollover cuts down errors. Sloped screen for glare reduction. Variable intensity brightness control. Extended function capability. Wide selection of transmission rates. VT-52 offers both upper and lower case characters with standard auxiliary keypad and cursor controls.

VT50 — \$1,300  
VT52 — \$2,095

**DECscope VT55**  
An on-line interactive CRT terminal for graphic waveform analysis. Two 512 point (maximum) graphs with text and graphics displayed simultaneously, two cursors, and a built-in hard copy line-for-line printer. Quiet, tilted screen, typewriter keyboard, three-key rollover, RT-11 BASIC & FOCAL software.  
\$2,495

**DECWRITER II**  
The low-cost, high reliability 30 cps, 132 col impact teletypewriter. 3 switch-selectable speeds, 7 x 7 dot matrix head, multiple forms handling, selectable line lengths, typewriter-style keyboard. Designed for mechanical simplicity. Accurate, easy-to-read printing. Quiet operation. The LA36 DECWRITER II.  
\$2,350

**LA180 DECprinter I**  
A 180 cps 132 col hard-copy matrix printer for high speed applications. Based on LA36 technology — for high-reliability, accurate printing. Long list of standard features make it a price/performance leader in matrix printers. Includes 11-position forms-length switch, paper-out switch/alarm, field-proven print head, multipart forms, adjustable vertical positioning, quiet.  
\$3,085



ments of work, time and money.

Digital's total system compatibility is the key. It's why you can come to Digital for totally integrated, totally flexible systems that earn their way on today's price and tomorrow's

potential. The potential to get bigger. To improve. And to stay competitive.

And with it all comes the Digital performance record that says new ideas and new systems will be here tomorrow, moving

into the new frontiers Digital OEMs are opening. So it's not just today's business, it's also tomorrow's business that OEMs are taking care of when they do business with Digital.

#### Mass Storage

##### Floppy Disk—RX-11 System

Brings high-reliability, low cost, compact mass storage to a new range of applications. Up to 256K words per drive, can be used as random-access file, data interchange, software distribution medium. Uses industry standard diskette, average access time 483 milliseconds. Head loading only when reading or writing, mechanical simplicity, easy to service. 10½ inch rack-mountable chassis. Either one or two drives.

**\$3,045**

##### Cartridge Disk—RK11 DECpack System

A low cost, reliable, mass storage, random access system with removable disk packs. Basic system includes RK05 cartridge disk drive plus controller. For multi-user, multi-programmed system applications. Over 1.2 million words of data per disk with up to 70 millisecond average access time. Up to 8 disks on one control unit.

**\$9,900**

##### Double Density Disk Drive—RK05F

A new, double density version of the proven RK05. 5.9 megabyte, non-removable disk drive, with a Data Rate of 1.44 Mb/s and BPI/TPI 2200/200.

**\$6,500**

##### Fixed-Head Disks—RJS03 & RJS04 Systems

For fast, reliable, on-line storage. Average access time 8.5 milliseconds, transfer rate 4 microseconds per word. Ideal for program swapping, real-time data acquisition, control applications. RJS03—up to 256K 18-bit words; RJS04—up to 512K 18-bit words.

**RJS03—\$14,900**

**RJS04—\$19,200**

##### Disk Packs—RJP04

Low cost per bit and high performance for on-line, direct access programming. 44 million words per disk up to a total of 8 drives in a PDP-11 system—350 million words. 2.5 microsecond per word transfer rate, 28 millisecond average seek time. Dual access option, overlapped positioning.

**\$35,000**

All hardware prices quoted are single quantity prices. Unit and dollar volume discounts are available. Quoted prices as of June 1, 1976, subject to change.

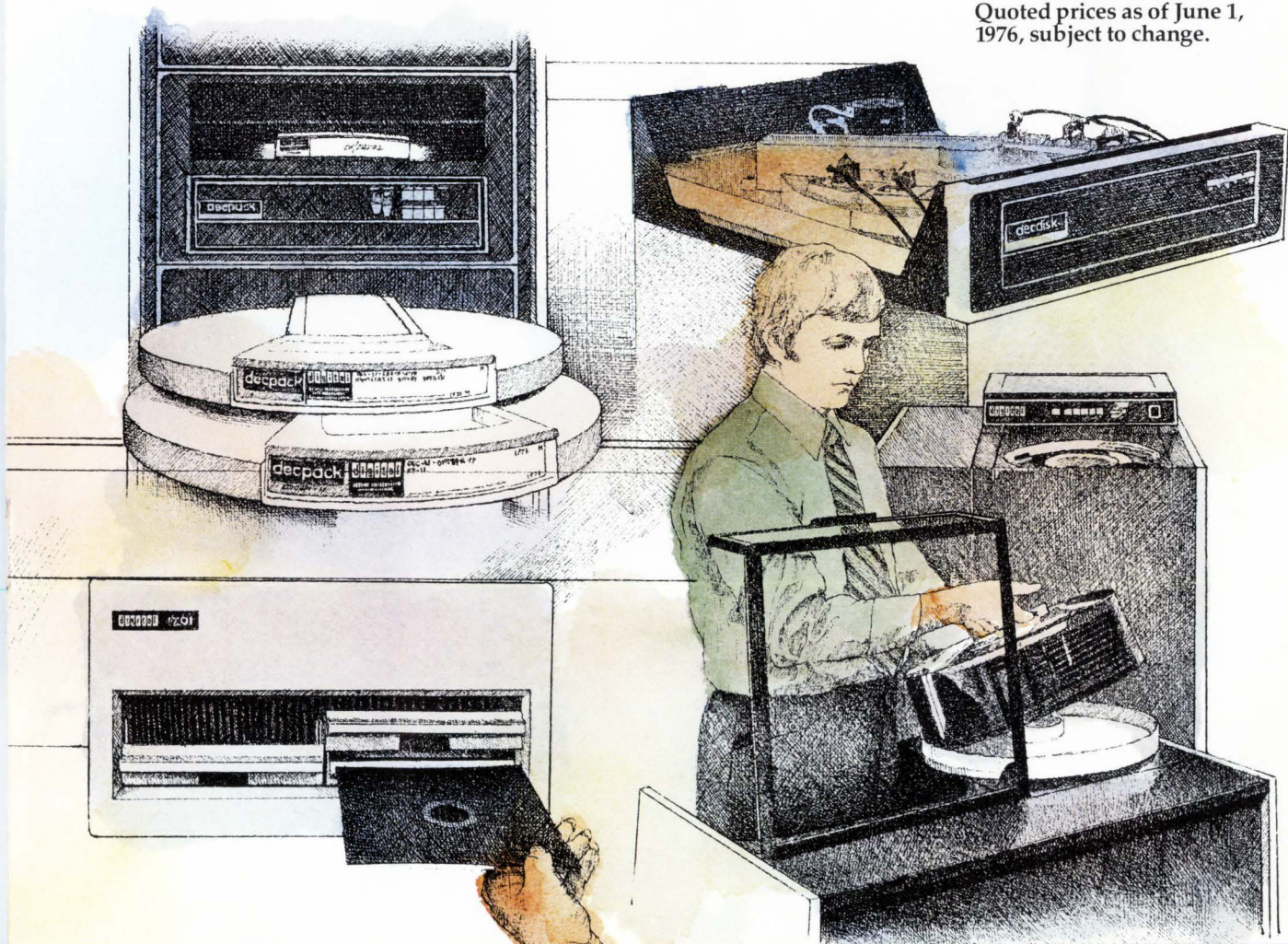

# Digital OEMs get ideas.

Digital's software and language support is designed to open avenues of exploration for creative OEMs.

RSX remains the state-of-the-art offering in real-time interactive systems. It's what has

let Digital OEMs do things like automate huge plants by automating one operation at a time. Or give a researcher his own computer system.

Meanwhile RSTS/E has made timesharing easily afford-

able for users who only a few years ago couldn't have considered it.

And all the while the evolution of ideas continues.

## Single-User Systems

**RT-11**—The start of PDP-11 software. Fast, simple, on-line access to 11s. A small, single-user disk-based operating system for interactive program development and/or on-line applications; supports single job and foreground/background processing modes. BASIC, FOCAL, FORTRAN Languages; utilities. Runs batch in background partition. Up to 28K words memory; wide range of peripherals.

**\$1,250**

**OS/8**—The 8 operating system. Disk or tape based. Features include modular system design, extensive peripheral support, ease of use, Dynamic Resource Allocation, Flexible Language Processing, Efficient PAL-8

Assembler and Comprehensive Software Tools. Languages include FOCAL, BASIC-8, FORTRAN IV and Industrial BASIC. Application packages for lab applications.

**\$400**

## Real-Time Systems

**RSX-11D**—Real-time, full batch and multiterminal program development capability. The total job computer system. Real-time multiprogramming, dynamic memory allocation, and fast. Supports DECNET.

**\$5,000**

**RSX-11M**—Subset of RSX-11D. Lower overhead system for known, well organized environment. Highly real-time responsive; multiprogramming. Background partition for program development. Supports DECNET.

**\$3,300**

**RSX-11S**—Subset of RSX-11M. A memory-based rapid real-time system for dedicated operations. Multiprogramming, low overhead, "execute only." Supports DECNET.

**\$1,500**

**RTS/8**—A multi-task, real-time system for the PDP-8A Family. Features Foreground/Background processing, priority allocation, resource management. Can handle up to 63 fixed-priority concurrent tasks.

**\$500**

## Timesharing Systems

### RSTS/E

A Resource Sharing, Timesharing System. Supports up to 63 simultaneous users interactively processing large amounts of data easily and efficiently. For small or large jobs. BASIC-PLUS, COBOL, or FORTRAN IV languages. Wide range of on-line processing capabilities based on flexible data file system. For systems level PDP-11s.

**\$5,500**

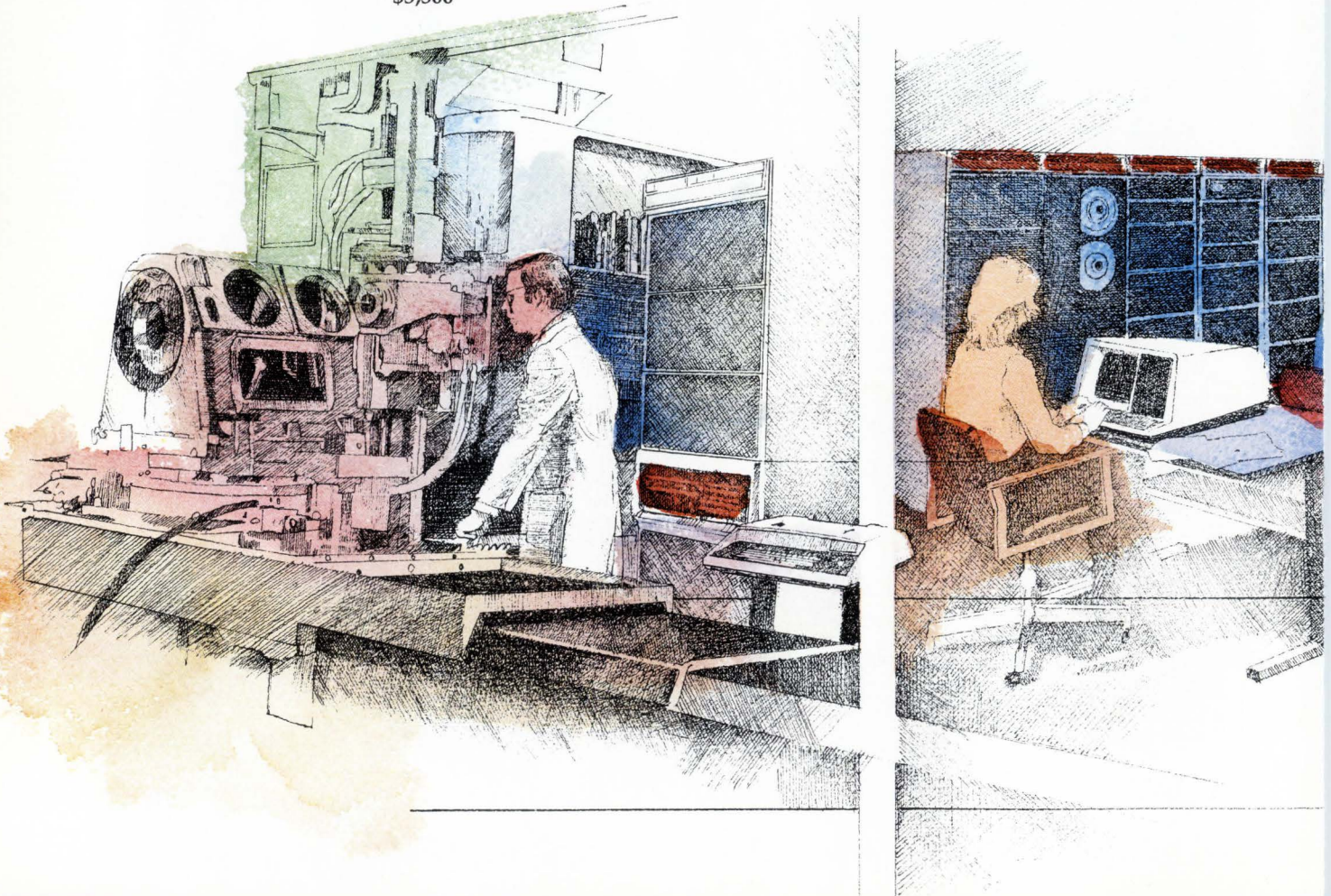



DECNET is a recent Digital offering that is already giving rise to computer networks with a whole new order of resource-sharing efficiency.

IAS is another new Digital idea. It promises to cut the cost

of multi-applications systems by as much as 75%.

And just introduced is Digital's new DBMS, the first CODASYL compatible data base management system for under \$100,000.

Ideas like these are why Digital computers keep going into new places first. And why Digital OEMs keep succeeding in their efforts to invent new ways to cut the cost of work.

#### Multifunction Systems

##### IAS—Interactive Application System

Designed for the PDP-11/70. Multi-user, multi-function operating system provides simultaneous time-sharing, batch, and real-time program development and execution. Supports FORTRAN, BASIC, COBOL, MACRO assembler. Also suitable for PDP-11/45.

**\$7,800**

##### DBMS-11

The first CODASYL Compatible Database Management System for \$15,000. Enables many discrete applications programs to access one central data base. Available for PDP-11/70. Features FORTRAN, BASIC, COBOL languages.

**\$15,000**

##### DECNET

A set of software tools designed to bring intersystem, program-to-program communications to Digital's PDP-11s, PDP-8s, PDP-15s, and DECsystem-10s. For Hierarchical, Distributed Processing, Resource Sharing, and Communications networks. Features include Device Sharing, File Sharing, Program and Program Data Sharing, Route through, Downline System and Executive Directives Loading.

**\$1,500**

#### LANGUAGES

The major high level 11-Family languages include:

##### FORTRAN IV/FORTRAN

**IV-PLUS**—for scientific and engineering applications; designed for speed and versatility; highly optimized; FORTRAN IV-PLUS for minimum execution times with asynchronous floating point processors.

**\$800 / \$3,000**

**COBOL**—fast direct-access data processing compiler for commercial applications.

High through-put for RSX-11D, RSTS/E, or IAS systems. Includes report generating utilities.

**\$7,000**

**BASIC/BASIC-PLUS**—the easy-to-learn conversational programming language; uses simple English words and abbreviations, common math symbols; powerful and fast; for RT-11, RSTS/E, IAS.

**\$750/(BASIC-PLUS included with RSTS/E)**

Prices reflect licenses for supported software, and are limited to a single central processor. Unit and dollar volume discounts are available.

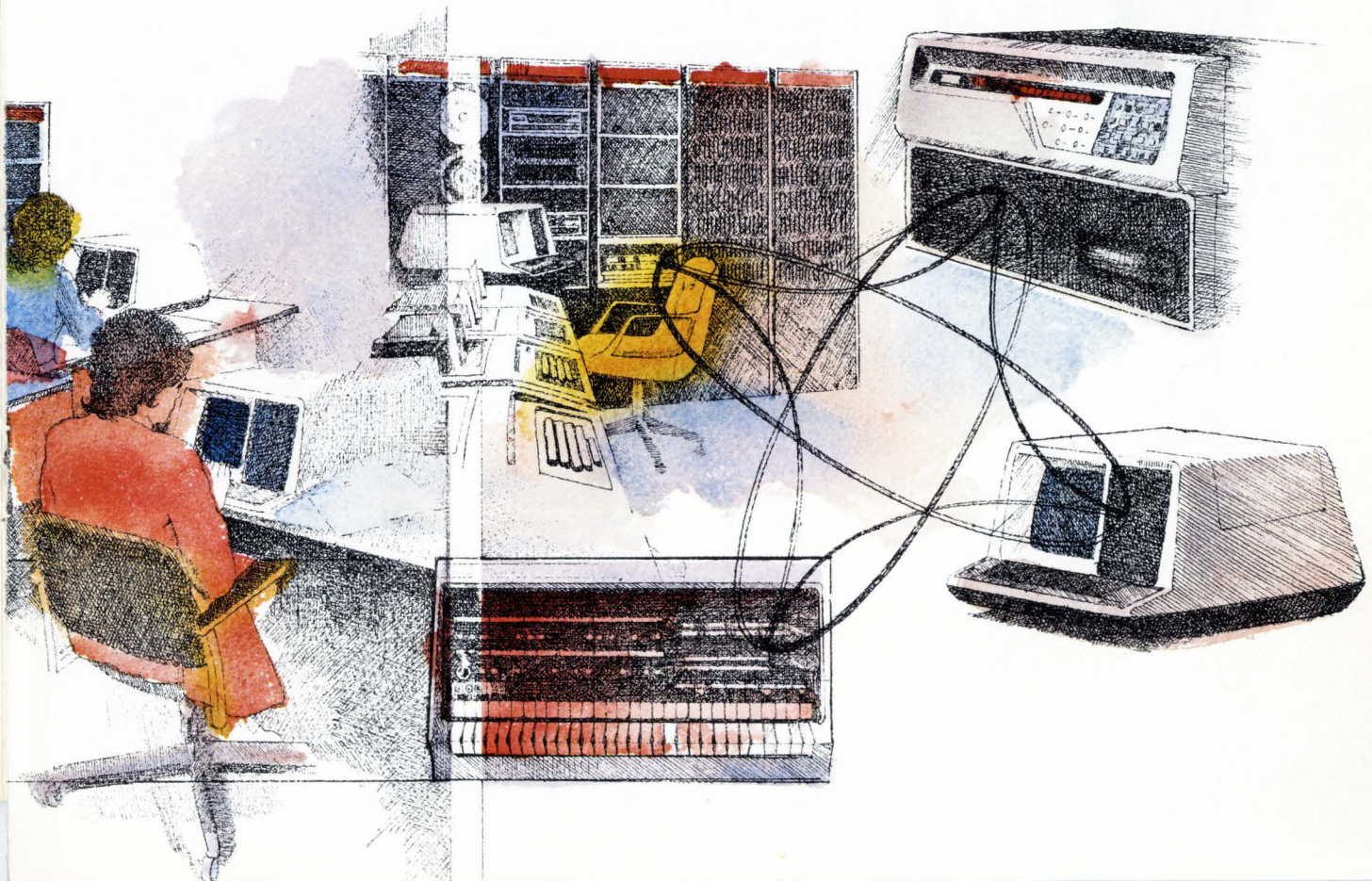

# Digital OEMs get Digital.

From its beginnings, Digital has sought to be the company an OEM could grow with over the long term.

And for this reason Digital Equipment Corporation has long offered OEMs a lot more than just Digital equipment.

We've offered service that in its depth and breadth is unique in the industry. Today Digital has over 3,000 field service experts in 300 cities and 30

countries around the world. Systems support, field training, and software expertise are as close as your phone — and just as close for your customers.

This support is the active extension of the OEM group at Digital, a group dedicated to knowing your business and how to help it grow. It's through this group that you have on-going access to Digital's resources including parts, spares, applica-

tions advice, the DECUS library of user software, technical documentation and more.

You could be one of them.

To find out how, mail us the coupon below.

Digital Equipment Corporation, Maynard, Mass. 01754. (617) 897-5111. European headquarters: 81 route de l'Aire, 1211 Geneva 26. Tel: 42 79 50. In Canada: Digital Equipment of Canada, Ltd.

## digital

**50,000 Computers Saving Managers Millions.**

My information needs are:	Digital Equipment Corporation
PDP-8 Family CPUs	<input type="checkbox"/> 146 Main Street, PK3/M28
PDP-11 Family CPUs	<input type="checkbox"/> Maynard, MA 01754
LSI-11 <input type="checkbox"/>	<input type="checkbox"/> Gentlemen:
11/03 <input type="checkbox"/> 11/45	<input type="checkbox"/> I'm interested in becoming a Digital OEM.
11/04 <input type="checkbox"/> 11T55	<input type="checkbox"/> I'm now a Digital OEM and my needs are expanding.
11/34 <input type="checkbox"/> 11/70	<input type="checkbox"/> I buy for re-sale.
<u>Terminals and Printers</u>	<input type="checkbox"/> I buy for my company's use.
VT50/52	<input type="checkbox"/> I expect to buy _____ (number) of systems over the next
VT55	<input type="checkbox"/> 24 months.
LA36 DECwriter II	<input type="checkbox"/> My system briefly described is: _____
LA180 DECprinter I	<input type="checkbox"/> _____
<u>Mass Storage</u>	<input type="checkbox"/> _____
Floppy Disk Systems	<input type="checkbox"/> _____
Cartridge Disk Systems	<input type="checkbox"/> _____
Fixed Head Disk Systems	<input type="checkbox"/> _____
Disk Pack Systems	<input type="checkbox"/> _____
Magnetic Tape Systems	<input type="checkbox"/> Name _____ Title _____
<u>Software</u>	Company _____
PDP-8 Family <input type="checkbox"/>	Address _____
PDP-11 Family <input type="checkbox"/>	City _____ State _____ Zip _____
RT-11 <input type="checkbox"/> IAS <input type="checkbox"/>	Phone _____
RSX-11 <input type="checkbox"/> DBMS <input type="checkbox"/>	
RSTS/E <input type="checkbox"/> DECNET <input type="checkbox"/>	

EN D E

# FEATURE ARTICLES FROM *ELECTRONICS* AVAILABLE IN REPRINT FORM

No. of  
copies  
wanted

## New reprints

- \_\_\_ R-606 Special issue—microprocessors \$4.00
- \_\_\_ R-600 World market report 1976 24 pp \$5.00
- \_\_\_ R-526 How reliable are today's components 16 pp \$3.00
- \_\_\_ R-524 Special report on bipolar large-scale integration 12 pp \$3.00
- \_\_\_ R-522 Special report on power semiconductors 12 pp \$3.00
- \_\_\_ R-514 Eight ways to better radio receiver design 6 pp \$3.00
- \_\_\_ R-512 Design of circuits for dangerous environments 4 pp \$3.00
- \_\_\_ R-510 Bipolar integration advances with I<sup>2</sup>L microprocessor 8 pp \$2.00
- \_\_\_ R-508 Designing microprocessors with standard-logic devices 12 pp \$3.00

## Charts

- \_\_\_ R-516 Electronic symbols (chart) \$2.00
- \_\_\_ R-211 Electromagnetic spectrum (16-page report and chart) \$4.00
- \_\_\_ R-213 Electromagnetic spectrum (chart) \$2.00
- \_\_\_ R-326 Optical spectrum (6-page report and chart) \$3.00
- \_\_\_ R-327 Optical spectrum (chart) \$2.00

## Books

- \_\_\_ R-520 Microprocessors—Electronics Book Series \$8.95
- \_\_\_ R-11 Computer-aided Design 135 pp \$4.00
- \_\_\_ R-032 Active Filters 88 pp \$4.00
- \_\_\_ R-031 Circuit Designer's Casebook 182 pp (U.S. only) \$5.50 (foreign) \$12.00

## Other Reprints

- \_\_\_ R-518 Special issue—productivity \$4.00
- \_\_\_ R-506 The case for component burn-in 7 pp \$2.00
- \_\_\_ R-434 Designing automated systems with the new standard interface 12 pp \$3.00
- \_\_\_ R-432 An update on communications satellites 8 pp \$2.00
- \_\_\_ R-430 Choosing the right bipolar transistor model for computer-aided design 20 pp \$3.00
- \_\_\_ R-428 Designing with low-cost lasers 6 pp \$2.00
- \_\_\_ R-504 U.S. forecast 1975 20 pp \$3.00
- \_\_\_ R-502 European forecast 1975 20 pp \$3.00
- \_\_\_ R-500 Japanese forecast 1975 16 pp \$3.00
- \_\_\_ All three forecasts \$7.50
- \_\_\_ R-426 Special issue—technology update 1974 \$4.00
- \_\_\_ R-424 Microprocessor applications 28 pp \$3.00
- \_\_\_ R-422 A microprogramable mini-computer 8 pp \$2.00
- \_\_\_ R-420 Computerized text-editing and typesetting 8 pp \$2.00
- \_\_\_ R-418 Computer analyses of rf circuits 8 pp \$2.00
- \_\_\_ R-416 Optical waveguides look brighter 8 pp \$2.00
- \_\_\_ R-414 The ion-implanted n-channel process 6 pp \$2.00
- \_\_\_ R-412 Liquid cooling of power semiconductors 6 pp \$2.00
- \_\_\_ R-410 Special report on passive components 16 pp \$3.00
- \_\_\_ R-408 Bringing sight to the blind 8 pp \$2.00
- \_\_\_ R-406 Designing with the new logic, C-MOS and bipolar 16 pp \$3.00
- \_\_\_ R-328 Special issue—pervasiveness of electronics \$2.00
- \_\_\_ R-324 Semiconductor memories are taking over data-storage applications 16 pp \$3.00
- \_\_\_ R-322 Special report: new displays complement old 10 pp \$2.00
- \_\_\_ R-320 Special report on designing with flat cable 14 pp \$3.00
- \_\_\_ R-318 Special report on auto electronics 16 pp \$3.00
- \_\_\_ R-316 Hybrid circuits solve tough design problems 16 pp \$3.00
- \_\_\_ R-312 Leadless, pluggable IC packages reduce costs 7 pp \$2.00
- \_\_\_ R-310 Penetration color tubes are enhancing information displays 6 pp \$2.00
- \_\_\_ R-308 Program for transition from nonlinear to linear transistor model 6 pp \$2.00
- \_\_\_ R-306 Charge-coupling improves its image, challenging video camera tubes 8 pp \$2.00
- \_\_\_ R-209 Semiconductor RAMs land computer mainframe jobs 15 pp \$2.00
- \_\_\_ R-207 Technology gap starts to close for computer peripherals 16 pp \$3.00
- \_\_\_ R-205 Bridging the analog and digital worlds with linear ICs 16 pp \$3.00
- \_\_\_ R-203 East Europe market report 16 pp \$2.00
- \_\_\_ R-113 Optoelectronics makes it at last 34 pp \$4.00
- \_\_\_ R-107 Wanted for the '70s: easier-to-program computers 24 pp \$3.00
- \_\_\_ R-104 The new concept for memory and imaging: charge-coupling 12 pp \$2.00
- \_\_\_ R-023 Special report on tomorrow's communications 32 pp \$3.50

### Payment must accompany your order

Make check or money order payable to Electronics Reprints. All orders are shipped prepaid by parcel post. Allow two to three weeks for delivery.

Back issues now available:  
1960 to 1969, \$5.00 each  
1970 to 1973, \$3.00 each  
1974 to 1975, \$4.00 each

### USE THIS PAGE AS YOUR ORDER FORM

Cost of orders \$ \_\_\_\_\_  
Plus 10% handling charge \$ \_\_\_\_\_  
TOTAL AMOUNT ENCLOSED \$ \_\_\_\_\_

Mail your order to:  
Janice Austin  
ELECTRONICS REPRINTS  
P.O. Box 669  
Hightstown, N.J. 08520

### SEND REPRINTS TO

Name \_\_\_\_\_  
Company \_\_\_\_\_ Dept. \_\_\_\_\_  
Street \_\_\_\_\_  
City \_\_\_\_\_ State \_\_\_\_\_ Zip \_\_\_\_\_

# Program the all-new 8620C sweeper

and make your next sweeper a precision signal source for many microwave measurement systems.

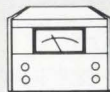

HP 8709A  
Phase-lock  
Synchronizer

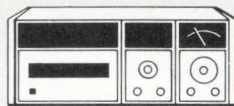

HP 8660  
Synthesized Signal Generator

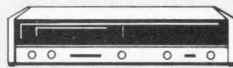

HP 5340A  
Frequency Counter



HP 436A  
Digital Power Meter

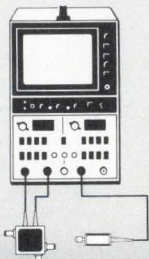

HP 8755  
Frequency Response  
Test Set

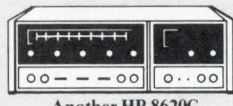

Another HP 8620C  
Sweeper



Combine the HP 8620C Sweeper Mainframe with optional HP-IB\* programming interface and an HP Programmable Calculator such as the HP 9830A. Together they'll let you digitally select frequencies between 10 MHz and 18 GHz with a resolution of 10,000 points per band.  Then by adding other HP-IB compatible instruments, you can configure a variety of practical test systems.

FOR EXAMPLE:

**2-18 GHz Phase-locked Synthesizer**  
with 15 Hz resolution and  $3 \times 10^{-9}$  stability.  
Extendable down to 1 MHz.

**Digital Frequency Control Loop**  
using microwave counter to achieve  
350 kHz frequency accuracy to 18 GHz.

**Precision Power Control Loop**  
using digital power meter to control output  
power with 0.02 dB resolution in a 10 dB  
window over a 120 dB range.

**2-18 GHz Frequency Response Test System**  
for semi-automatic simultaneous  
measurement of transmission and reflection.

**Sweeping Two-tone Test Source**  
with phase-locked IF offset for wideband  
front-end component tests.

These are described in our application notes —  
yours for the asking.

\*HP-IB is Hewlett-Packard's implementation of IEEE Standard 488 and identical ANSI Standard MC1.1 "Digital interface for programmable instrumentation."

The 8620C Mainframe gives you the sweep modes you need for both wide and narrow scans. Plus markers to pinpoint frequencies of interest. You have several methods for RF coverage and all give you the high performance you need: Two multi-octave plug-ins span 10 MHz to 2.4 GHz or 2 to 18 GHz; six economical singleband plug-ins collectively cover from 10 MHz to 18 GHz; or you can configure your own multiband with up to three RF modules in a plug-in drawer (five modules from 0.1 to 12.4 GHz are offered). In short, you'll get all the features you're ever likely to need in a sweeper — features you'll use for years to come.

Can  
any other  
sweeper do  
as well?

HEWLETT  PACKARD

Sales and service from 172 offices in 65 countries.  
1507 Page Mill Road, Palo Alto, California 94304

# Little left of receiving-tube market

60 million units should be sold this year, compared to peak of 182 million in 1957, as RCA closes Harrison plant

by Bruce Le Boss, New York bureau manager

RCA Corp.'s decision to close its Harrison, N.J., receiving-tube plant on April 30—three months earlier than planned—not only marked the end of an era that spanned five decades, it also had major ramifications for surviving manufacturers, suppliers, and consumers.

Few can question the decision of RCA, the leading maker of receiving tubes, to cease manufacturing for a market that has declined by almost 80% since 1966. Yet the firm's departure as a producer of most high-use receiving tubes and as the sole source for more than 100 less-used types has led to worries over shortages, longer lead times, higher prices, and deterioration of receiving-tube quality.

What's left of the receiving-tube market today primarily is a renewal/replacement market that is but a shadow of its former self. Still declining from a peak of approximately 182 million units in 1957, the replacement market last year was down to about 68 million units. Estimates for the current year set the market at about 60 million units.

**Decline.** "It's inevitable that the replacement market will continue to decline," says Joseph Haimés, a vice president at RCA's Distributor & Special Products division in Cherry Hill, N.J., and a veteran of the firm's receiving-tube business. "There are no new tube-based TV sets, other than a few hybrids, that are going on the market. And as the public scraps their old TV sets, the replacement market will continue to go down further."

The decline in the replacement market has been surpassed only by that of the OEM market. Since it



**Out of the business.** With receiving tube sales down to a small fraction of their peak, RCA has closed its Harrison, N.J. tube plant, will phase out its plants in Mexico and Brazil.

peaked at an estimated 273 million units in 1953, it has plummeted to approximately 8.6 million units in 1975, and a further drop to 4.6 million units is forecast for this year. "For all intents and purposes the OEM market has been wiped out," says Haimés.

The remaining two segments of the receiving-tube business—the export and Government markets—were never actually that big, notes Haimés. The export market hit a peak of 24 million units in 1954, and the Government segment hit its high of 43 million units three years later. The two segments this year are projected at 5 million units and 7 million units, respectively.

In its heyday, RCA's receiving-tube operations encompassed three additional production facilities in the U.S., with plants in Cincinnati, Indianapolis, and Woodbridge, N.J., as well as offshore plants in Mexico and Brazil. The Harrison plant,

where RCA produced over 3 billion receiving tubes, was the last and largest of the domestic tube-producing facilities. RCA is trying to sell the Mexican plant, which produced about 7 million tubes annually, and it plans to phase out tube operations in Brazil, where approximately 15 million tubes were made annually, says Haimés.

**Who's left?** RCA's withdrawal as a producer of receiving tubes leaves GTE Sylvania and General Electric as the principal U.S. manufacturers in the business; Westinghouse and Raytheon have previously ceased production. RCA will follow in Raytheon's footsteps by continuing to merchandise tubes—buying and selling RCA-branded units after it depletes its current inventory.

In addition to Raytheon, which sells tubes made by Nippon Electric Co. and Matsushita Ltd., the primary Japanese manufacturers, the U.S. market is filled with a host of

## Probing the news

suppliers. Amperex is buying and selling tubes made by its N.V. Philips affiliates and others, and International Electronics Corp. and International Components Corp. are selling tubes produced offshore, as are many others. Also OEMs, such as Zenith, Motorola, and Magnavox, as well as major retailers, such as Sears, Roebuck & Co. and Montgomery Ward, are merchandising tubes.

As a result of the abundance of suppliers, and RCA's arrangements to transfer production to other makers Haimes doesn't consider that RCA's departure as a manufacturer will seriously affect the supply situation. For example, RCA alone made the Nuvistor, a thimble-size, metal-ceramic tube that was RCA's low-cost response to transistors about 12 years ago. Recognizing the need for someone to continue to supply Nuvistors for replacement in television receivers and government equipment, RCA reached an agreement with Sylvania for the sale of machinery, parts, raw materials, work in process, and technical data related to the manufacture of Nuvistors and certain other sole-source receiving tubes that were produced at the Harrison plant. Nuvistor production is being set up at Sylvania's Emporium, Pa., facility, while the manufacture of more than 50 other types of tubes for which RCA was the sole source is being shifted to Sylvania's automated production plant in Altoona, Pa.

Commenting on Sylvania's plans to supply the market with Nuvistors, Roger Slinkman, senior vice president for the Electronic Components group, notes that Sylvania recognized that its ability to serve the market depended on the purchase of certain machinery, tools, and parts. "That taken care of, we have already made delivery commitments to customers. We are proceeding according to plan, with few exceptions, and plan to be making shipments by the end of this year," Slinkman says.

Meanwhile, RCA expects to fill most of the military's requirements this year for Nuvistors, as well as for certain metal tubes, but the military

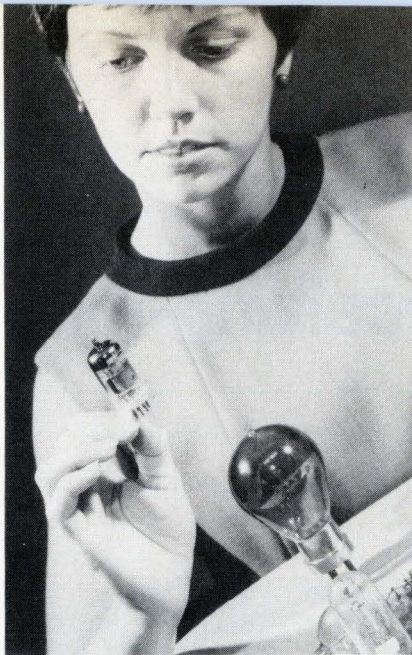

**End of the run.** Some of the billions of tubes made by RCA are five decades old.

is skeptical. At the Defense Electronics Supply Center (DESC) in Dayton, Ohio, Col. William Warren, the production manager, is concerned about the delivery of certain tubes for which RCA was the sole source, noting Sylvania is "not yet on-stream."

This void in some metal tubes critical to military applications will partially be filled by General Electric, says Al M. Penrod, manager of marketing for receiving tubes at GE's plant in Owensboro, Ky. "As a result of the RCA pull-out, GE is going back into the metal-tube business, at least producing the popular ones, to serve the military market," notes Penrod.

Other than for some of those RCA sole-source tubes, Penrod says, there will be no availability problem. "Both Sylvania and GE can supply the world's needs from now on to evermore. And if either one of us decides to drop out, the other could handle the world's requirements by itself," he states.

**Shortages seen.** But Robert Knight, marketing manager at Raytheon's Distributor Products operation in Burlington, Mass., predicts that availability will become a problem and that there will be shortages of many critical types. "As the market shrinks, there will become less of a market for certain low-use tubes. Therefore, manufacturers will become less willing to produce quantities sufficient to achieve manufacturing efficiencies," he says, noting

that most factories need at least 10,000 units of a given type to break even on that tube.

"A manufacturing manager who goes out to produce a tube, if he produces just 3,000 or 4,000 units, he's just getting the bugs out. These were the units that used to be taken out for the renewal market, with the debugged units that followed in the run going to the OEMs, who were much more critical," Knight adds.

**Distributors.** So far, RCA's departure as a producer of receiving tubes doesn't seem to have had any immediate effect on distributor operations. Frank Viscomi, president of Westchester Electronics Inc. in White Plains, N.Y., a major RCA distributor, says there has been no impact on tube availability yet, "largely because RCA is still shipping out of inventory." But Viscomi assumes a problem in obtaining an adequate supply of RCA-branded tubes, so he has taken on a second line.

Jack Socolow, president of Northeastern Radio Warehouse Inc. in the Bronx, N.Y., another large RCA-tube distributor, doesn't expect the RCA action to encourage the remaining two U.S. manufacturers to raise prices beyond what might be considered the usual increases. "That's because you have a company like Zenith, which purchases all of its tubes from outside sources, and they're very price-competitive and aggressive in the market."

Raytheon's Knight expects upward price pressure because competition is being decreased. This, in turn, could result in the loss of certain business at the consumer/dealer level. "If people get greedy and prices go up too high, then consumers will begin to throw away their old TV sets. It's already happening to black-and-white TV. Rather than pay \$6 to \$8 each for several tubes, plus a service charge by a technician, the consumer can go out and buy a black-and-white TV for \$70 today."

Helping to temper the rate of expected price increases could be some downward pressure by some of the peripheral suppliers who might dump their products on the market. "This could be the next phase following upward prices," says Knight. □

# Who's the performance winner in 16k and 32k memory systems?

## Check the specs.

Fabri-Tek has packed more speed and total performance into single-board 16K and 32K memory systems than anybody else in the business. Compare our 696 and 698 systems against the competition, and you'll see what we mean. We'll not only beat them in specifications—we're the only company that offers you total upward compatibility to 32K. At competitive prices, too. It's what you'd expect from a company with years of leadership in the memory business. Go with the winner—call us today for the best in both off-the-shelf and custom memory systems.

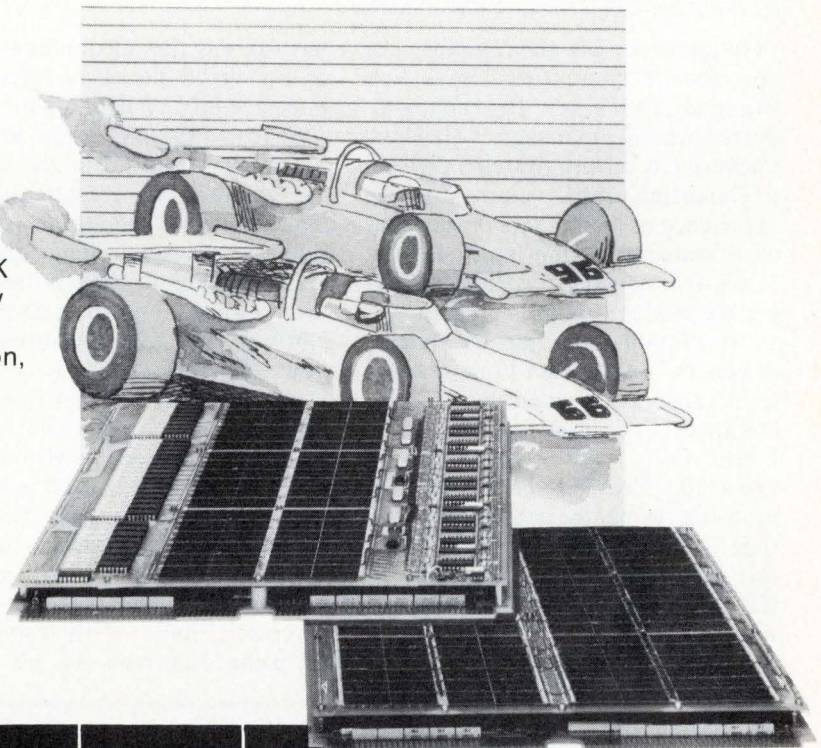

MODEL	FABRI-TEK		EMM		DATA PRODUCTS		DATA RAM	
	696	698	Micro 3000 D.D.	Micro 3000 Q.D.	Store 1680		DR-103	DR-103
MEMORY SIZE	16K	32K	16K	32K	16K	32K	16K	32K
CYCLE TIME	650	650	650	850	650		650	750
ACCESS TIME	250	250	270	300	280		265	300
PHYSICAL SIZE	11.75x15.4 x1.0	11.75x15.4 x1.0	11.75x15.4 x1.0	11.75x15.4 x1.0	11.75x15.4 x1.0		11.5x13.7 x1.0	11.5x13.7 x1.0
COMPATIBILITY 16K TO 32K	YES		NO		NO		NO	

**FABRI-TEK INC.**  
**COMPUTER SYSTEMS**

5901 South County Road 18 • Minneapolis, MN 55436 • (612) 935-8811

**SALES OFFICES:**

Boston  
 (617) 969-5077  
 Tom Fitzgerald

Chicago  
 (312) 437-4116  
 Bruce Richardson

Dallas  
 (214) 661-3155  
 Al Yarnell

Hawthorne, Calif.  
 (213) 973-0484  
 Wally Harrison  
 Don DeVries

San Jose, Calif.  
 (408) 246-8391  
 John French

Minneapolis  
 (612) 935-8811  
 Jack Graham

Instrumentation

## Standard interface gains fans

But some prospective users are concerned about slow speed of bus, and one even objects to \$250 licensing fee

by Andy Santoni, Instrumentation Editor

"The pioneers got their lumps, but now they're committed," says Bob Brannon. That's how Brannon, product-marketing manager at Hewlett-Packard Co.'s Data Systems division in Cupertino, Calif., summarizes the experience of many users of the standard instrumentation-interface bus, IEEE 488, now that systems employing the bus are up and running.

"It simplifies our job as systems designers," says Ralph Prall, manager of support-equipment engineering at Singer Co.'s Kearfott division in Little Falls, N.J. As would be expected, Kearfott engineers had problems using the system the first time around, says Prall. The interface-bus software they wrote for an HP 21 MX minicomputer did not work as expected, he says, and that called for a major rewrite. "But HP worked very closely with us to solve the problem, and we're satisfied with the results. We're going to continue to use the standard interface; it looks like an economical solution to many of our problems."

Brannon adds that difficulties with the minicomputer hardware and software that drive the standard interface also caused HP to take a second look. That reassessment resulted in a new version of the interface card and a greatly expanded software package, the 59310B [*Electronics*, May 27, p.145]. "We think we've licked the problems of the earlier version," says Brannon.

**Learning.** "I see few real problems, other than that people are still in the early phase of using it," says David Kaufman, senior project engineer at Data Precision Corp. in Wakefield, Mass. Among the limitations often discussed by prospective

bus users is the maximum data rate of 1 megabit per second across the interface on any signal line.

Says Kaufman, "We are very much concerned about the speed of the bus, and we are attempting to make the unit operate at as high a rate as the controlling microprocessor will allow. The bus itself is not the limiting factor in most systems; hardware has often been more of a limitation than bus capacity."

Kaufman notes that if the circuitry between the instrument and the bus cable operates slowly, it would appear that the bus itself is slow. In its interface cards, says Kaufman, Data Precision is using an 8-bit microprocessor that will operate more rapidly than the 4-bit microprocessors some of its competitors are using. Kaufman says his compa-

ny plans to offer a 488 bus interface as an option on its systems-oriented instruments.

**Option.** Howard Painter, marketing manager of GenRad Inc.'s Electronic Instrument division in Concord, Mass., agrees that the bus is a good idea, "but it does have speed limitations. Some of our customers might want more speed, so they'd prefer parallel outputs instead of a serial output." Painter says that, in the future, GenRad will design systems with a bus option, but won't include it as a standard part.

Henry Reineke, vice president of operations at Wavetek, San Diego, says that, while acceptance is growing rapidly, it is not yet "revolutionary," or at the 50% point of all potential users. Reineke says that although 10% of Wavetek's ship-

### What the standard covers

Based on a concept developed by Hewlett-Packard Co., the standard instrumentation interface bus has been adopted by the United Kingdom's Institute of Electrical and Electronics Engineers (IEE Std. 488-1975) and by the American National Standards Institute (ANSI MC1.1-1975). The interface also is in the final stages of approval as an International Electrotechnical Commission standard [*Electronics*, Jan. 22, p. 8]. It is often called the general-purpose interface bus (GPIB) or, because it employs the American Standard Code for Information Interchange, the ASCII bus.

The standard defines the bus's physical connector, the roles of the interconnecting bus wires, the logic conventions, format, and timing of control and data signals, plus the other factors necessary to operate in a communications link. The objective is to simplify the interconnection of instruments and peripherals, including computers, voltmeters, and card readers, made anywhere in the world.

In operation, each device linked via the interface is connected in parallel to three buses. The data bus transfers both data and addresses among the devices in a bit-parallel, byte-serial fashion. The transfer bus controls the transfer of data on the data bus. The control bus performs such control functions as channeling a service request from a device to attract the attention of the controller, and it handles the remote-enable instruction that tells a device to respond to remote programing rather than to its own.



ments last year were bus-compatible, 30% to 50% of the units shipped this year are so equipped.

**German assessment.** For Rohde & Schwarz in Munich, West Germany, Tonio Fruehauf, head of the firm's design laboratory for automated test equipment, remarks: "System speed is no limitation because the interface bus is used only in analog equipment, and not in digital systems." About half the instrument systems made by the company are bus-compatible.

Much the same comment comes from Siemens AG, which is getting ready to deliver bus-compatible analog test systems during the second half of this year, as well as from Wandel & Goltermann, also a German producer of test equipment primarily for communications systems, which is now developing bus-compatible systems. Both also agree that the speed limitation is not a drawback.

**French opinion.** Yves Le Peutrec, an instrumentation-marketing engineer for Compteurs Schlumberger, admits that the 1-Mb/s maximum speed could be a handicap, but estimates that some 20% of instrumentation buyers want programable, bus-compatible instruments. Schlumberger will offer bus compatibility on all its new programable instruments, either standard or optional, starting this year.

Art Bjerke, engineering manager at Systron-Donner Corp., Concord, Calif., says his firm will make the 488 standard bus "available as an optional assembly in many of our instruments" and already builds bus compatibility into some products. Bjerke says the standard is convenient "for people who are not able financially or technically to put together a system." Systron-Donner's Norm Whitla agrees: for small systems, "it's fine. But in a big system, where you're pumping a lot of data around, it may be useless. It only moves as fast as the slowest instrument, and that may not be good enough for assemblers of big systems."

This drawback, along with the cost added to each instrument to achieve interface compatibility, makes the standard interface too expensive and cumbersome for com-

# AIRPAX™

## UPG Delay 66 Circuit Protector



## Problem Solver!

### Problem:

Customer had a 1/3 hp, 115 volt single phase capacitor-run 3450 rpm motor. Running current was 4.6 amperes and starting current was 28 amperes with a start-up time of 1.6 seconds.

He needed overload protection that was faster than that supplied by the internal sensors and a fairly quick dropout in case of a jammed load or stalled rotor.

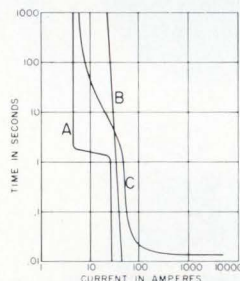

Time vs Current  
A — Motor Characteristics  
B — 15A Fuse  
C — UPG Delay 66, 5A

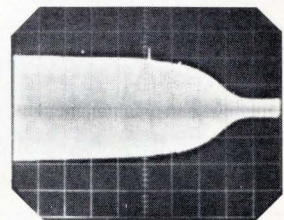

Start-up Current Envelope  
Vertical 7.5 amps rms/div.  
Horizontal .2 sec./div.

In order to start the motor without blowing a fuse, he was forced to use a 15 ampere rating. This gave him stalled rotor protection at about 10 seconds, but no overload protection.

The standard long delay magnetic protector required a 7 1/2 amp rating to be able to turn his motor on reliably. This gave him his stalled rotor protection at about 5 seconds, and overload protection at 200%. Still not good enough.

### Solution:

The Airpax UPG Delay 66, at 5 amp rating eliminated this problem with turn on . . . locked rotor protection at about 4 1/2 seconds . . . and overload protection at about 150% on nameplate in approximately 400 seconds. This allowed short periods of overload without nuisance tripping. His problem was solved. (Delay 66 is also available in larger Airpax Type 219 and 229 Molded Case units up through 100 amperes.)

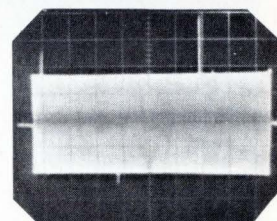

Stalled Rotor Trip Out  
Vertical 7.5 amps rms/div.  
Horizontal .5 sec./div.

If you have an application with a special protection problem, call Airpax Electronics at Cambridge, Maryland (301-228-4600) or write for literature on Airpax Circuit Protectors and Circuit Breakers.

# AIRPAX™

**AIRPAX ELECTRONICS  
CAMBRIDGE DIVISION**  
Cambridge, Maryland 21613 • Telex 8-7715 • TWX: 710-865-9655  
Other Airpax Divisions:  
CONTROLS DIVISION, Ft. Lauderdale, Florida  
Instruments for Industry  
AMERICAN DATA, Huntsville, Alabama  
TV Products

# Our carry-in recorder/reproducer will carry on for 32.8 hours!

The 70-lb. Sabre VI: It's a giant leap beyond any other small, high performance IRIG analog tape recorder/reproducer. Records at 8 electrically selectable speeds: 120 ips through 15/16 ips; reproduces at any 3 electrically selectable speeds; records from 15.3 minutes at the highest speed to 32.8 hours at the slowest on 14" reels. Remote speed selection and LED footage counter. LED bar data monitor. Let us give you full details.

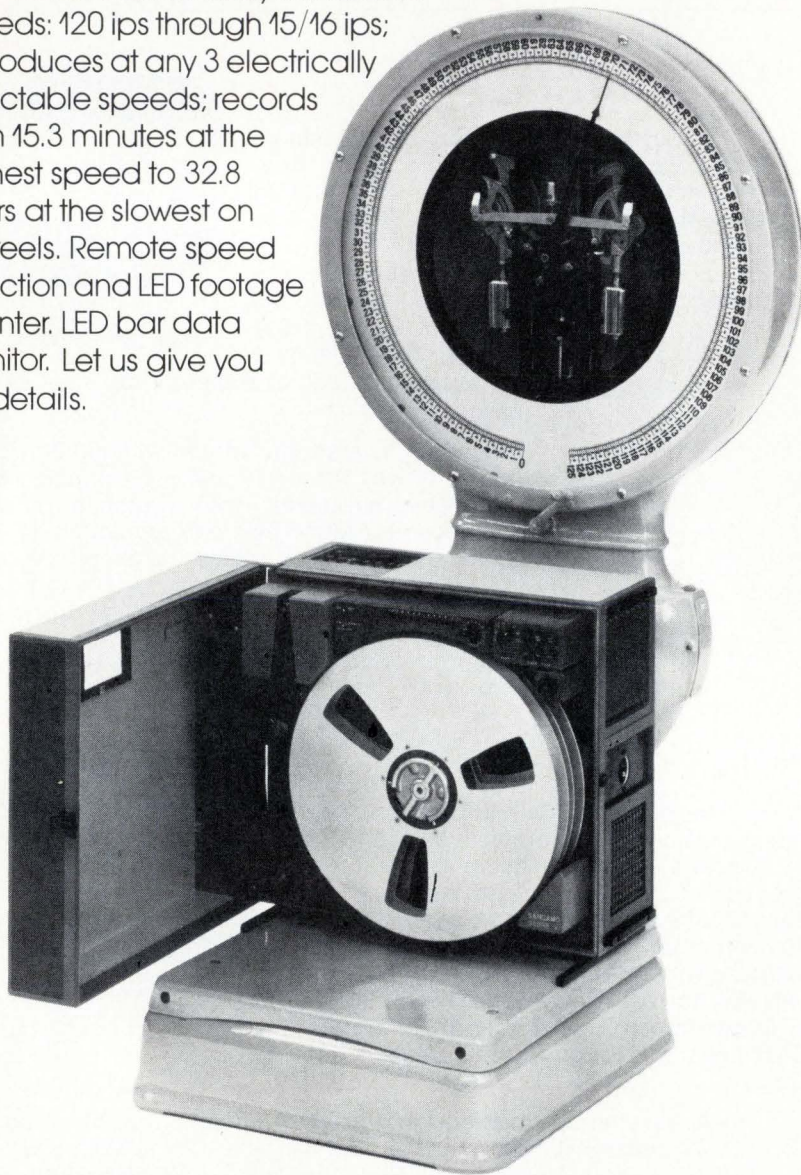

## SANGAMO RECORDERS

THE INNOVATORS IN TAPE INSTRUMENTATION

Sangamo Electric Company

Data Systems

P.O. Box 3347 • Springfield, Illinois 62714

(217) 544-6411

## Probing the news

mercial test systems like those made by Teradyne Inc. of Boston, or Instrumentation Engineering of Franklin Lakes, N.J. When a number of nearly identical systems are to be built, a more custom interface system may be preferred. James P. Sutter, director of corporate marketing at Datatron Inc. of Irvine, Calif., notes that the standard interface is "not applicable to our hard-wired, dedicated-computer approach."

**Testing.** Nonetheless, some vendors of commercial test systems are using the standard instrument interface. For example, Faultfinders Inc. of Latham, N.Y., incorporates compatibility with IEEE-488 in its latest in-circuit and functional automatic test system, the model FF303. Controlled by a Data General Nova minicomputer, the FF303 includes bus compatibility to simplify expansion or alteration of the tester by the user, says Fred Schwedner, manager of electrical engineering at the firm.

The major fault Schwedner finds in the standard is the complexity of its documentation. "It's a bewildering document," he says, pointing out the over-reliance on state diagrams and mnemonics to explain simple operations.

And Clark Crocker, manager of advanced-instrumentation development for engineering-data-conversion systems at Analogic Corp. in Wakefield, Mass., doesn't like the idea of paying a license fee to use an industry standard. Crocker says standards that benefit the entire industry should be free to use.

**Reasons.** Discussing these two complaints, Don Loughry, corporate interface engineer at HP in Palo Alto, Calif., explains, first, that the document is complex and written at a high technical level "because it was written as a reference, not for training." As for the licensing requirement, Loughry says that the terms are quite reasonable. "For a single payment of \$250, you get a royalty-free license to use the bus," he says. Anyone can purchase such a license, he says, then use the standard interface on any number of products. □

Reporting for this article was provided by Pamela Leven, Judith Curtis, Larry Armstrong, John Gosch, Arthur L. Erikson, and Larry Waller

# EMC FILTER

## CAPITAL OF THE WORLD

FROM CERAMIC POWDER TO MIL-APPROVED TEST LAB...  
ERIE HAS IT ALL, UNDER ONE ROOF

Only one company can deliver your total EMC Ceramic Filter needs . . . ERIE. We've been applying sophisticated ceramic and related technologies to developing superior filters for 35 years. Today ERIE has, by far, the broadest line of subminiature EMC Filters in the world. From tiny high frequency filters to broad band filters to custom filter assemblies, ERIE offers the ultimate in quality. And you get single-source responsibility too, for we build the complete filter in a plant devoted exclusively to the design and manufacture of EMC Filters. So come to ERIE for your filter needs. We'll put a team to work on your particular application. Aerospace. Communications. Avionics. Industrial Equipment. Whatever the market, we can help eliminate electromagnetic "noise" and emissions. In the meantime, write for our complete catalog . . . EMC Filters or call 613/392-2581.

ERIE TECHNOLOGICAL PRODUCTS, INC.  
Erie, Pennsylvania 16512

# ERIE

Circle 73 on reader service card



Companies

## For ITT, staying at home pays

Semiconductor chief Heinz Roessle says that decision to automate in Europe rather than go offshore has kept operation healthy

**For Heinz Roessle**, deputy general manager of the ITT Semiconductor group, one of the factors in the formula for success is automated production. Not that other companies haven't done the same, but at ITT Semiconductors, mechanization and automation have become articles of faith. Perhaps nowhere is as strong as effort being made toward automation as at the group's European facilities, headed by Roessle.

And the figures show that the effort has paid off. Mainly as a result of automated processes, per-employee sales at the European facilities now stand at \$50,000 a year. This level, Roessle says, compares with \$40,000 to \$45,000 for the group as a whole and with around \$30,000 for the semiconductor industry generally. Furthermore, automated processes have helped the group to operate profitably, even during the recent slump.

Roessle, a soft-spoken yet aggressive executive, is directly responsible for ITT's three semiconductor companies in Europe—in Footscray, England, Colmar, France, and Freiburg, West Germany. Last year, they accounted for nearly \$100 million worth of sales.

By far the biggest member of the group is Intermetall GmbH in Freiburg. The company, which accounts for more than half of ITT Semiconductors' worldwide business, is one of Europe's largest producers of solid-state devices for consumer applications. It pioneered in diode tuning for television sets in the mid-1960s and is among the leaders in developing wireless remote control, digital tuning, and electronic channel selection for television receivers.

Intermetall is also Europe's largest producer of MOS circuits for consumer uses. Roessle, a 19-year veteran of the semiconductor industry, recently discussed his views on a variety of subjects with *Electronics*. Here are excerpts of that discussion:

*Q. Why did you decide in the late 1960s against shifting manufacturing operations to the Far East?*

A. For one thing, we already were designing the products to lend themselves to low-cost automated-production processes. For example, transistor and IC systems were designed for automatic-bonding techniques. Another reason was to be near our customers and to keep logistics costs low. Further, we wanted to hold inventories down. This way, there would be fewer risks, as regards product mix and obsolescence.

*Q. How does being near your customers benefit you?*

A. Consider plastic transistors, for example. It's easy to get such standard devices in the Far East, but many of our customers, especially consumer-equipment makers, must react fast. This they can do best when their component suppliers are nearby. So, even with standard devices, being close to the user has a bearing on orders. Our market share, even for standard devices, is considerable. As for specialized consumer products, it's even more important to be near the user.

*Q. How much are you spending for automation?*

A. That's continuing process. But I would say the ITT Semiconductor group spends something like \$2 million a year just for developing the means for automation and mechanization. Compared with total sales,

the \$2 million may not sound like much, but most firms spend a smaller percentage. More important than the actual amount, however, is where the money is put to use, and I believe we have spent the money where it does us the most good.

*Q. Who develops the automation equipment?*

A. We do that ourselves because, in most cases, the equipment cannot be bought outside when we need it.

*Q. For all your efforts in streamlining production, is there room for more automation?*

A. Sure. We have more development projects going on. In one, a single person supervises three or more machines used for fully automatic circuit production. Let me emphasize that the person's function is purely supervisory.

*Q. Is the level of automation you have achieved attainable at other semicon-*

**Stay at home.** For ITT Semiconductor's Heinz Roessle, automation is profitable.

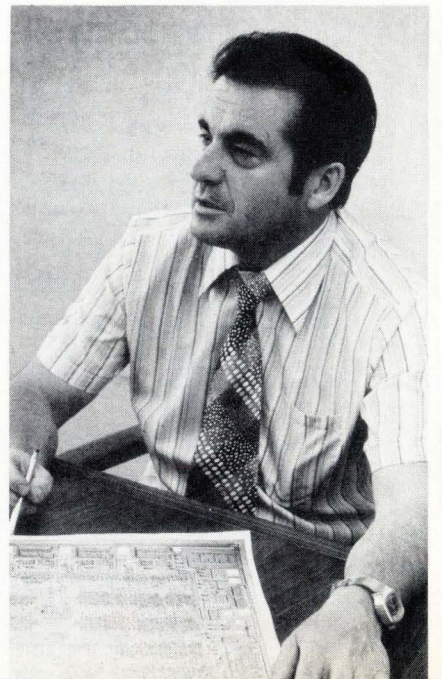

# A new and better way to get crisp, clear facsimile-type records of sonar, radar, or IR thermography.

## Honeywell's new 1856A linescan recorder.

The Model 1856A from Honeywell reflects a real advancement in fiber-optic CRT technology. Offers high resolution recordings (greater than 100 line pairs/inch), a broad gray scale capability, intensity modulation to 8 MHz, variable sweep range of  $2\mu\text{sec}$  to 1 sec/cm and 1 cm pk-pk vertical recordings from dc to 75 kHz, with a choice of recording media.

In addition to print-out papers, the 1856A offers even greater flexibility through your choice of two accessory magazine assemblies. The Model 1218A, light-tight and self-contained, permits the use of recording papers and films for wet chemical photoprocessing to obtain an even

greater resolution, and optimum reproducibility. When high writing and record speeds are not required, the Model 1219 Processor provides dry-processed high contrast or gray scale recordings on paper or film.

For complete technical specifications, call or write Bob Shipman, Honeywell Test Instruments Division, P.O. Box 5227, Denver, Colorado 80217. (303) 771-4700.

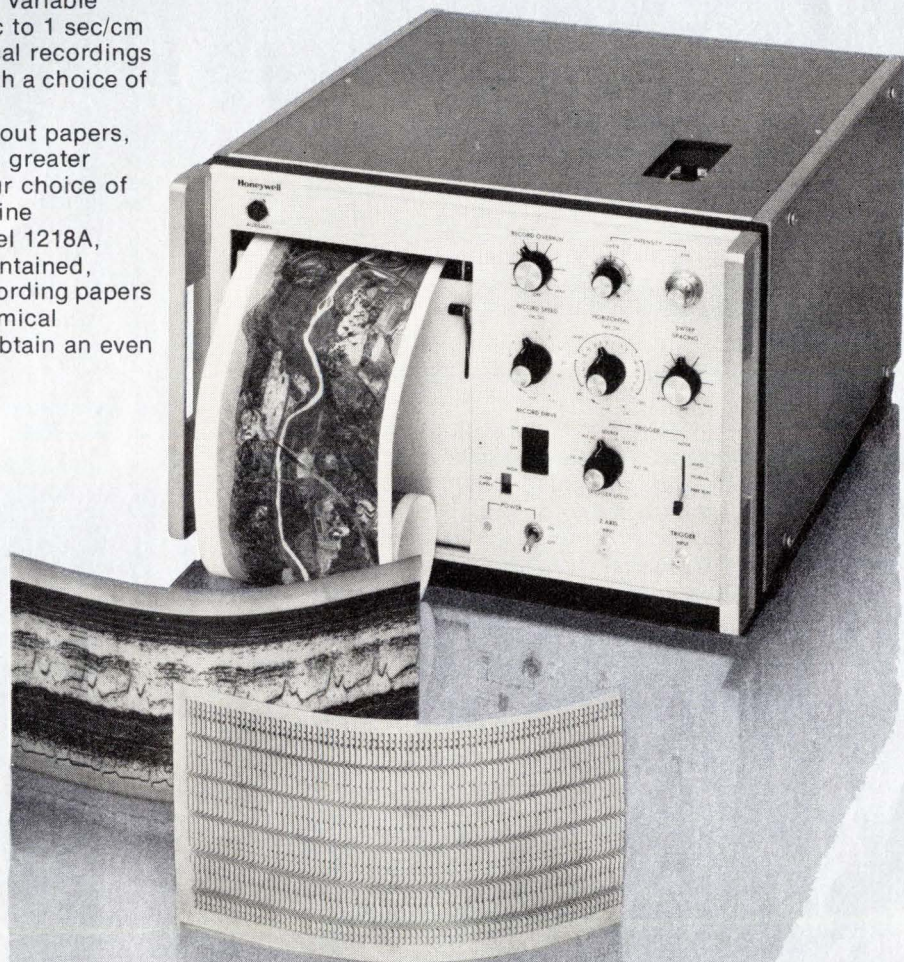

# Honeywell

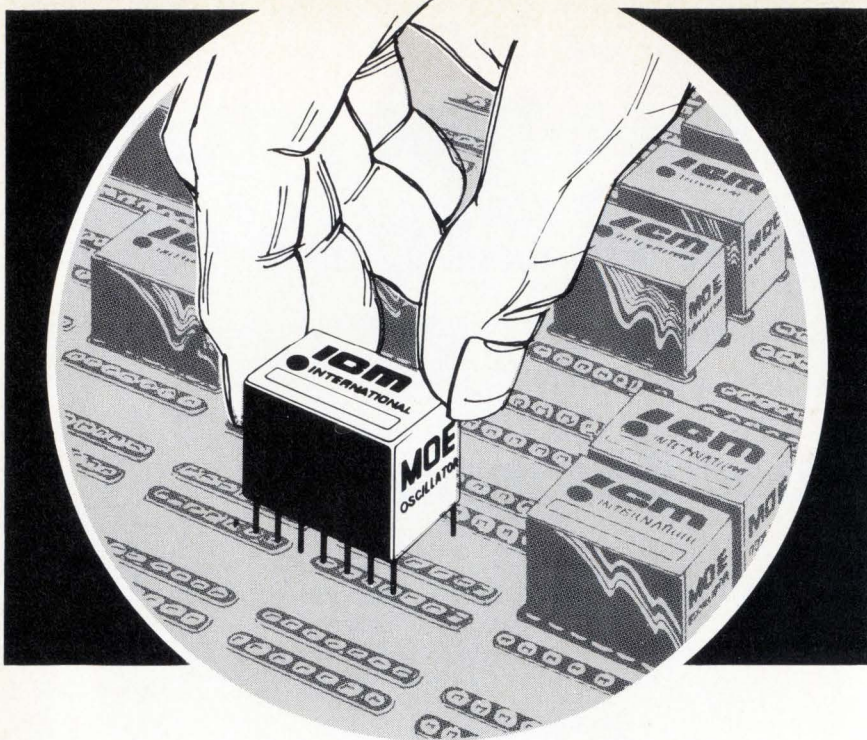

INTERNATIONAL'S  
**moe**  
**CRYSTAL OSCILLATOR  
 ELEMENTS**

**A Complete Controlled Signal Source from 6000 KHz to 60 MHz**

The MOE series is designed for direct plug-in to a standard dip socket. The miniature oscillator element is a complete source, crystal controlled, in an integrated circuit 14 pin dual-in-line package with a height of 1/2 inch.

Oscillators are grouped by frequency and temperature stability thus giving the user a selection of the overall accuracy desired. Operating voltage 6 vdc. Output wave shape — non sine.

TYPE	CRYSTAL RANGE	OVERALL ACCURACY	25°C TOLERANCE	PRICE
MOE-5	6000KHz to 60MHz	+ .002% -10° to +60°C	Zero Trimmer	\$35.00
MOE-10	6000KHz to 60MHz	+ .0005% -10° to +60°C	Zero Trimmer	\$50.00

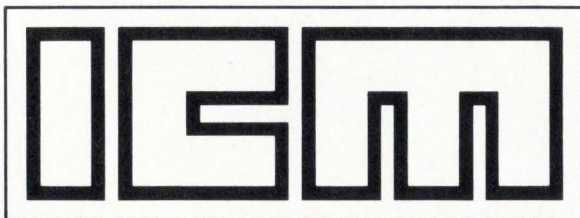

**International Crystal Manufacturing Company, Inc.**

10 North Lee, Oklahoma City, Oklahoma 73102

**Probing the news**

*ductor houses? Could they readily adopt your techniques?*

A. It's not all that easy. Mechanization requires an experienced staff of mechanical engineers and a good team that can maintain the machines. In this respect, the Black Forest region with its long tradition in precision-instrument making, exemplified by its clock and watch industries, has benefited us a lot. Certainly, a high degree of mechanization is possible at other firms. But first they must change their production philosophy. There must be a strong will to become a factory—I mean a factory in the traditional sense of the word—a production facility where battles are fought over fractions of pennies.

*Q. Is ITT Semiconductors developing any new technologies or refining existing ones?*

A. No. We are not interested in developing technologies just for technology's sake. Our main goal is to develop products using MOS, C-MOS, PL, and the like.

*Q. Are you gravitating toward any particular technology?*

A. Not at all. If a technology lends itself to economical fabrication of a certain product, we will use it. Occasionally, we will settle for a more sophisticated technology if it enhances production. Take channel selection and ultrasound remote-control of TV sets. Here, we decided on silicon-gate over the simpler metal-gate processes because it runs well in our factories in volume device production. Our philosophy is to develop a product with which we think we can get a good market share. The technology is secondary.

*Q. What are your near-term plans in microprocessors?*

A. We don't intend to develop a microprocessor of our own. Rather, our aim is to cooperate with a company that already has knowhow in the field and then go to market with a common system. Many of our own LSI circuits, like those designed for TV remote control and channel-number storage, and our ICs for coin-operated, worldwide dialing phones, already have the complexity of microprocessors. □

# Motorola switches on SWITCHMODE II.\*

## The world's fastest Darlington.

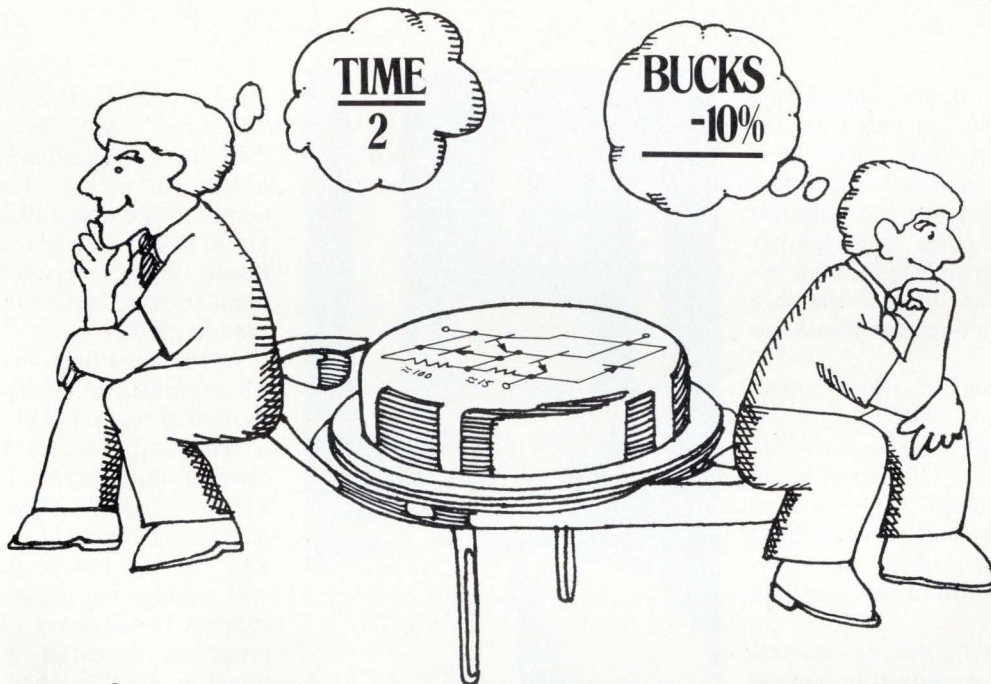

### If you can't use the speed, think about the money.

When we say fast, we mean fast — like 40 nanosecond typical inductive fall time at 10 amps.

Switchmode II MJ10004-07 silicon power turns off twice as fast as any other high-current, high-voltage Darlington. Period.

The faster, the better — and at twice the speed, switching losses are cut in half. That's efficiency anyone can use.

It's all because of Motorola's recognized leadership in power Darlings. We introduced 'em, refined 'em and keep coming up with the right parts for today's applications.

The new 10 and 20 amp units are perfect examples.

Literally.

Besides offering up to 450-volt sustaining capability, they're true Switchmode devices with all the essentials for high-frequency, 200°C inductive use spelled out on Designers\* Data Sheets. Up to 5,500-volt-ampere RBSOA capability. High-temperature, clamped inductive load switching specs. Switching times as functions of collector current and temperature. Spec'd limits for active region SOA. Maximized stability through high-performance glass passivation. Optimized B/E resistor values and current gain.

Switchmode II is the biggest story in years in switching Darlings.

You've got a chance to read it

in our special Switchmode literature package of Designers\* Data Sheets, Selector Guide and application notes. Write Motorola Semiconductor Products, Inc., Box 20912, Phoenix, AZ 85036, or use your in-plant VSMF center.

Oh, yeah, the money. You pay less for the MJ10004 family. Right. Less than competitive parts. At up-to-999 prices of \$4.50 to \$9.50, you can save a bundle over parts that are microseconds slower.

Think about that on the way to the bank.

\*Trademark Motorola Inc.

**SUPERPOWER**  
unlimited

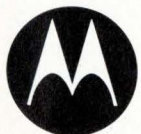

# MOTOROLA Semiconductors

Military electronics

# Slimmer Samsco maintains strength

Internal reorganization and more work by outside contractors enable Air Force missile organization to add to work load

by Larry Waller, Los Angeles bureau manager

The Air Force's Space and Missile Systems Organization sports a leaner profile these days, and it is working to stay that way. The reason, of course, is the familiar duo—zooming costs and budget hold-downs—that is whiplashing everyone has also forced the big missiles and space-research outfit to trim down.

One indication of what Samsco calls "doing more with less" is the cut in its worldwide staff, which has been reduced nearly 20% from 6,500 in 1970 to about 5,200 today. Another is its budget, almost equal to 1970's \$2.15 billion, but with more than one third of its value lost to inflation.

Samsco's belt-tightening started eight years ago, explains the present commander, Lt. Gen. Thomas W. Morgan, who adds that the squeeze stems mostly from soaring "people costs," as it does throughout the Air Force. In the 1970s, Samsco faced a thorny combination of austere budgets and a growing workload. But now, Samsco, based in El Segundo, Calif., oversees "14 major activities, which is up 50% over the past few years."

Further complicating the bind are the demands to put state-of-the-art technology into advanced programs and the Air Force's absolute-reliability requirement for weapons systems. Together, these necessities defied a simple solution by across-the-board cutback, according to Morgan.

**Strategy.** Without sacrificing performance, Samsco's strategy became one of trimming and reorganizing internally. It also began hiring outside contractors for its operating



**In charge.** Heading the more austere Air Force Space and Missile Systems Organization is Lt. Gen. Thomas W. Morgan.

jobs, especially to replace its own "blue-suit" Air Force contingent. "We just cannot afford the luxury of having all blue suits," Morgan admits. "We would like it otherwise, but it's not cost-effective." As the result, today's service complement numbers less than 3,400—600 fewer than in 1970.

At the same time, marked changes were transforming the important System Program Offices, each of which had previously operated as a division unto itself, to manage a Samsco project. "The Air Force philosophy always was that each SPO was entirely independent, with its own engineering, finance, and other support," he notes. But as new programs appeared without additional funding, "we had to man them out of our own hide," and existing offices were raided.

Setting up pooled support functions for all SPOs helped meet the staffing gap. Samsco, particularly, went to outside contractors to run its extensive launching and tracking responsibilities, which include Vandenberg Air Force Base and Air Force satellite control.

Through consolidation and reprogramming, overseen by a manpower review board instituted last year, enough personnel were raised, in fact, to staff the brand-new programs. These were the Navstar global positioning system [*Electronics*, Oct. 15, 1975 p. 39] and the defense dissemination system, a top-secret project about which Samsco is saying nothing.

**Supervision.** But there was no thinning out or pooling of the basic technical responsibility for each program. "We've drawn the line at



# Dialight LED Displays

The widest choice for your every application.

engineering" for each program, Morgan stresses.

To strengthen supervision and transfer of technology throughout Samsco, a new directorate of Advanced Space Programs was formed earlier this year, and it includes the former technology office. Its charter includes "looking across all programs for quality assurance," which Morgan calls a consideration of overriding importance for all programs.

The reliability of solid-state electronic devices in space still causes headaches, even after intensive and continuing efforts to improve procurement and testing. Today, Samsco has been operating devices for five years or more in orbit, compared with nine months early in the programs.

Stringent fabrication standards, identification of each component, and testing at every level—from the individual part to the entire system—get the credit, Morgan explains. "Many systems work well on the ground, but in space, contaminants float loose and short out circuits," he complains. The new directorate is charged with pursuing ever more rigorous control and testing programs.

**Sophistication.** In looking over Samsco's range of programs, in which exotic technology is commonplace, the commander describes the laser-satellite system as probably "the most advanced communications system ever to be built." Designed to provide the ultimate capability for the Department of Defense, it employs lasers to link orbiting satellites with each other and to ground stations.

Among other characteristics, the system is expected to transmit and receive 1 billion bits of data per second, about 20 times the rate of present commercial satellites, and it simultaneously handles about 50,000 voice or 12 color-television channels. A late 1979 evaluation launch is planned by Samsco.

Morgan took over Samsco late last year after an earlier hitch in 1971-72 as vice commander. Even with this experience, he says the complexity of Samsco operations required "at least three months for me to catch up." □

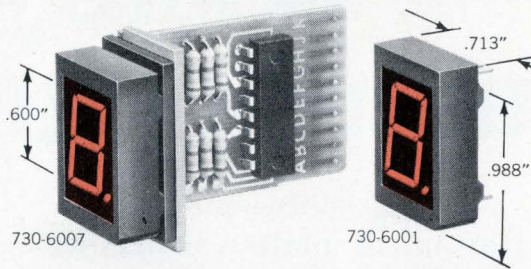

**730 SERIES** A new 0.600" LED character in super bright red, seven-segmented readout . . . low power . . . draws 10mA/segment or less . . . operates with standard IC power supply levels. Very high contrast ratio . . . visible from 40'. Available with or without on-board decoder/driver, plus or minus bar, and with bezel mounting. In 1000-lot quantities each LED  
**730-6007 . . . . \$6.05. 730-6001 . . . . \$2.55.**

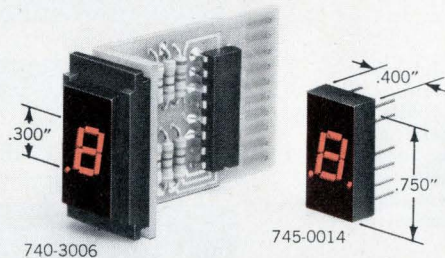

**745 SERIES** A new 0.300" LED character in a very bright red, seven-segmented readout . . . low power requirements. Standard 14-pin DIP . . . available with left and right decimal with  $\pm 1$ , and with and without on-board decoder/driver. Compatible with most TTL and DTL circuits. In 1000-lot quantities each  
**740-3006 . . . . \$6.43. 745-0014 . . . . \$2.10.**



Dialight, the company with the widest choice in switches, LEDs, indicator lights and readouts, looks for needs . . . your needs . . . and then they develop solutions for your every application. No other company offers you one-stop shopping in all these product areas. And no other company has more experience in the visual display field. Dialight helps you do more

with these products than any other company in the business, because we are specialists that have done more with them. Talk to the specialists at Dialight first. You won't have to talk to anyone else. Send for your free new copy of Dialight's current catalog.

**DIALIGHT**

Dialight, A North American Philips Company  
 203 Harrison Place, Brooklyn, N. Y. 11237  
 (212) 497-7600

# See Dialight.

# Ask yourself 5 questions before you buy your next signal generator.

1. How much spurious signal output will my receiver test tolerate?
2. Do I require calibrated AM & FM?
3. Is continuous tuning along with phase lock best for my test procedure?
4. Do I need a separate, low RFI counter?
5. Could my transceiver be keyed during test?

**1.** Fundamental L-C type oscillator gives spectrally pure signals from 10-520 MHz in 6 bands. Sub-harmonic and non-harmonic spurious outputs are >100 dB down. No spurious "cross-overs" typical of synthesized or heterodyned generators.

**2.** Accurate, calibrated, metered modulation, both AM and FM. Internal source 400, 1000 Hz. AM: 0-90%. FM: 0-3, 10, 30, 100 kHz deviation. FM possible during phase-lock.

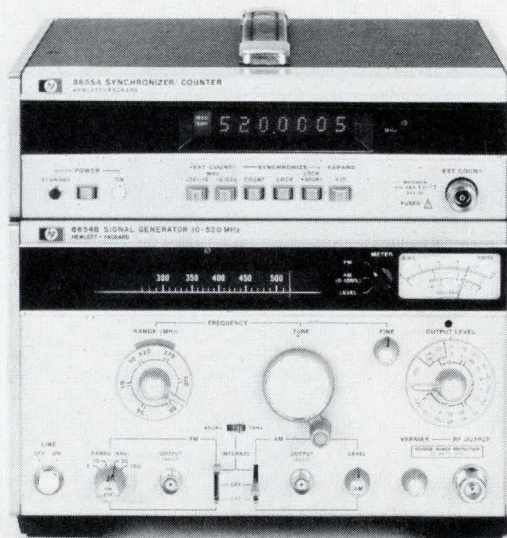

8654B with Option 003, 8655A

**3.** Continuous tuning along with phase-lock stability gives best human interface for many receiver tests. No step-tuning jumps typical of synthesized generators. Push 8655A Counter/Synchronizer phase-lock button for 0.1 ppm/hr. stability.

**4.** Well shielded counter circuits exhibit RFI less than  $1.5\mu\text{V}$  for use near high-sensitivity receivers. Also use for external counting of transceiver output to 520 MHz.

**5.** Reverse power protect (Option 003) ensures against possible damage from accidental keying of transceiver to 25W. Output is levelled, calibrated, and adjustable from +10 to -130 dBm ( $0.7\text{V}$  to  $0.07\mu\text{V}$ ).

After you analyze your receiver test procedures, we think you'll find that the HP 8654B Generator can fill most, if not all, of your requirements. It has good spectral purity, low spurious, and calibrated AM and FM. The 8654B is really hard to beat for price and performance in an economy signal generator.

Add the 8655A Synchronizer/Counter and get high frequency accuracy, 500 Hz resolution, low drift, and low RFI. For most transceiver testing, this combination may answer all your questions.

HP8654B, \$2450\*; Option 003 (reverse power), \$300\*; HP8655A, \$2075\*; HP8654A (FM uncalibrated), \$2000\*

For more information, give your nearby HP field engineer a call, or write.

\*Domestic US prices only.

**HEWLETT  PACKARD**

Sales and service from 172 offices in 65 countries.  
1501 Page Mill Road, Palo Alto, California 94304

04508A

For assistance call: Washington (301) 948-6370, Chicago (312) 677-0400, Atlanta (404) 434-4000, Los Angeles (213) 877-1282, Toronto (416) 678-9430

# FIBER-OPTIC DEVELOPMENTS SPARK WORLDWIDE INTEREST

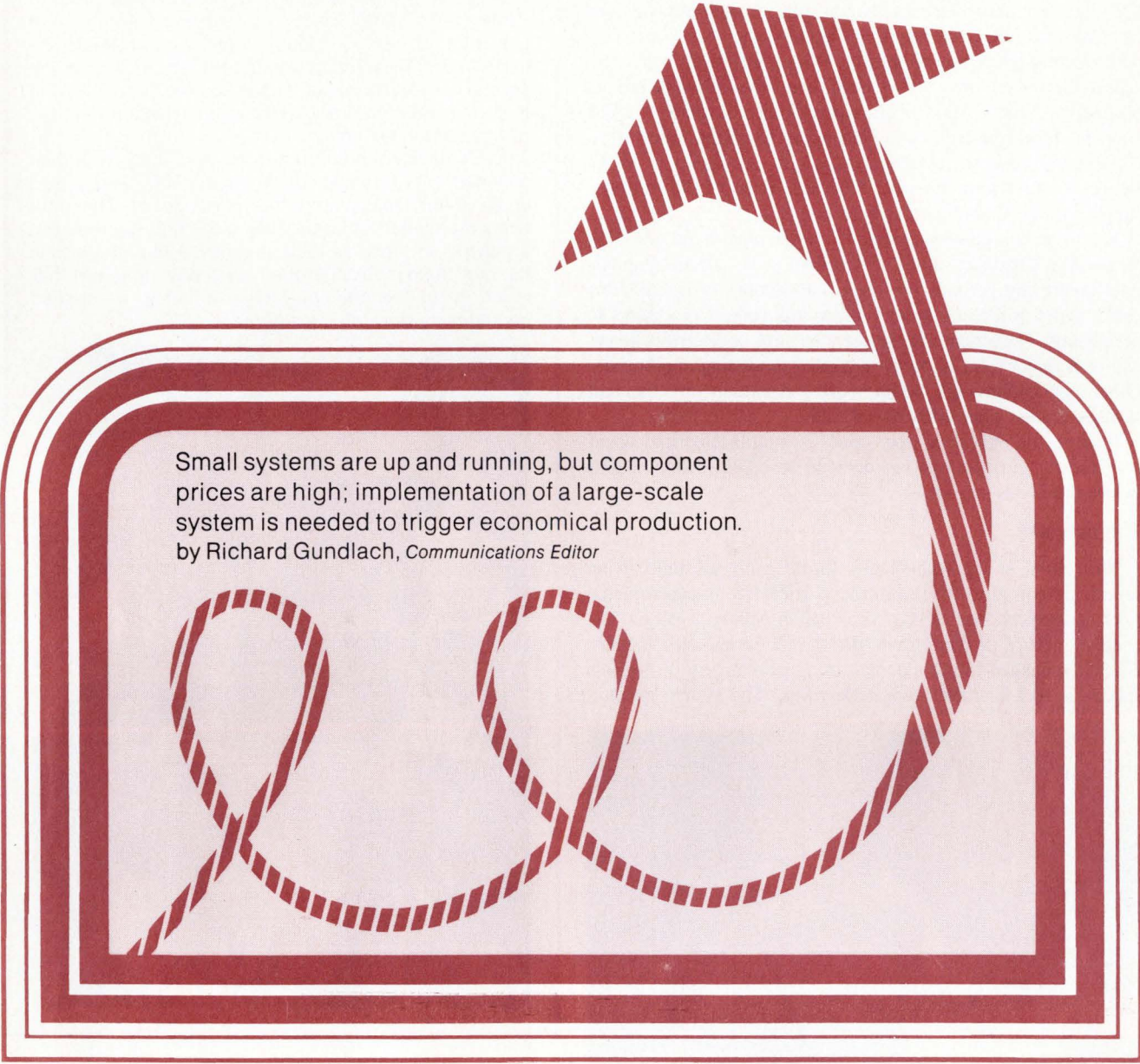

Small systems are up and running, but component prices are high; implementation of a large-scale system is needed to trigger economical production.

by Richard Gundlach, *Communications Editor*

□ The advances made in the last year in fiber-optic communications have delighted even the most optimistic. New systems have done better than expected in rigorous field trials. Improved components—more efficient light sources, less noisy photodetectors, and more rugged cables—have become available off the shelf. Single-fiber cables, plus matching connectors, are starting to surface, while production techniques are attracting the kind of attention that's the due only of nearly mature technologies.

Commercial applications, in fact, have leapt into prominence, both in the U.S. and overseas, and the military remain as dedicated as ever to the pursuit of the interference-free, light-

weight attractions of fiber-optic systems. For the time being, to be sure, cost remains a problem. Other difficulties include a lack of standards (though several groups are already at work in this area) and the unfamiliarity of the wider engineering community with such a new technology. However, there seems to be no doubt that by the 1980s optical fibers will often be a practical alternative to copper wire.

When that time comes, one of the major fiber-optic users will be the telephone system, and John deButts, chairman of AT&T has apparently firmly committed the Bell System to developing fiber optics. "I anticipate that by the early 1980s cables of glass

fibers will be carrying thousands of simultaneous messages between major switching centers in our cities," he recently stated. The fibers not only offer large bandwidths for such multichannel transmissions but, more important initially, they easily interface with existing telephone equipment. With their lower losses, too, repeaters can be more widely spaced than is possible with present conductive-cable systems. This aspect is also attractive to Bell Canada. It will probably use fiber optics to obtain repeaterless connections between telephone exchanges, according to W. C. Benger, group vice president of Northern Telecom Ltd., a major supplier to the Canadian telephone company.

For large data-processing systems, on the other hand, the large bandwidth capability and the freedom from electromagnetic interference are perhaps the biggest attractions of optical-fiber cable, which is already being used to link central processors to peripherals. The absence of the spark hazards of electrical signals will be a major asset in many industrial processing applications. Other applications will be won over, eventually, by the cost savings of glass fiber over coaxial cable.

In sum, the appeal of fiber optics is multifaceted and could (say the top analysts) rocket demand to billion dollar heights before the 1980s are out.

### The actuality

This vision of the technology's future gains substance from several systems already in existence, particularly an experimental fiber-optic telephone link started by Bell in Atlanta, Georgia, last January. There, a team from Bell Laboratories and Western Electric managed to put together, using as many as 18 low-loss splices, a 10.9-kilometer repeaterless link. The system encoun-

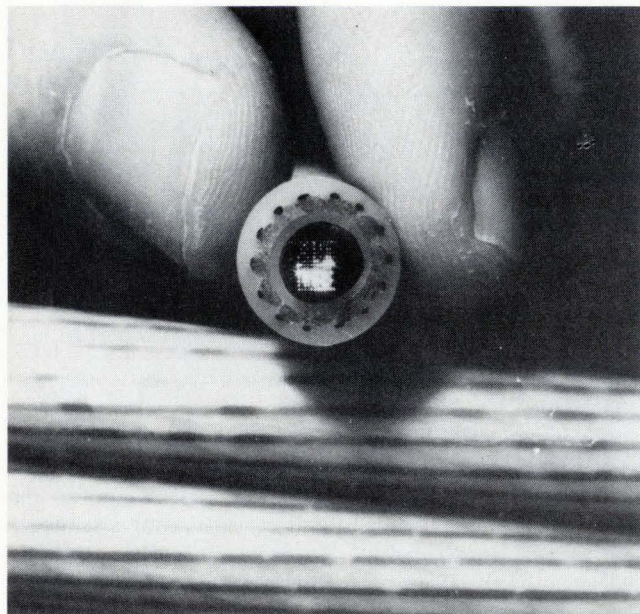

**1. Looking into fibers.** The optical-fiber cables used in Bell's field experiment in Atlanta are only half an inch in diameter, yet their 144 fibers operating at a 44.7-Mb/s data rate can carry the equivalent of over 48,000 simultaneous telephone conversations.

### Making fibers

A Western Electric pilot production line for optical fibers is already in operation. Making the fibers takes several hours, and the slightest variation in the process at any point renders the fiber unusable. First, oxides are deposited by chemical vaporization on the inside of a 3-foot-long tube of quartz glass, called a preform (shown upper right). Next, the preform is collapsed and pulled into a hair-thin optical fiber. A torch heats the preform as it moves at a preset rate. This builds up the several core layers of germanium-doped silicon dioxide that are needed to produce the varying refractive index of a graded-index fiber.

These high-silica-content glass preforms are then softened in a furnace (shown upper left) and pulled under slight tension into thin glass fibers. The pure fibers are coated before reaching the take-up reel with a polymer to preserve their strength. Although glass in the pure state is stronger than steel, any impurities that touch it before the protective coating is applied degrades its strength considerably.



tered no problems when transmitting data at 44.7 megabits per second. Average loss of the cable when in place was 6 decibels/km—2 dB better than the design goal. The experiment proved that it's possible to run fiber-optic links long enough to avoid the need to put repeaters in manholes every mile or so, as is necessary with coaxial-cable systems in large metropolitan areas like New York or Chicago. Just as important, the link interfaced successfully with existing telephone equipment, as the technology will have to do when it first enters the present telephone network.

Also eliminated by the experiment was the uncertainty whether practical connectors could be produced to splice together

in the field cable containing 144 separate fibers, each a mere 2 mils in diameter. The answer was a kind of club sandwich connector, with a dozen 12-fiber ribbons as the filling and 13 precisely grooved aluminum chips as the slices of bread.

Another fiber-optic system carries television signals. Tele-Prompter Manhattan Cable Television Cable Inc. just recently installed an 800-foot fiber-optic link to carry cable TV signals from a roof antenna to its head-end equipment 34 floors below. And General Telephone and Electronics Corp. is firming up plans for its scheduled field trials later this year that will carry actual commercial voice traffic between operating telephone exchanges in California. It will use cable made by General Cable Corp. of Greenwich, Conn.

Over in France—to focus on just one major overseas application of fiber optics—the Centre National d'Etudes des Télécommunications has already completed one experimental digital transmission system. (It's the start of an ambitious effort to develop the hardware and systems know-how that the government-run telephone network will need for the fiber-optic links it plans to have in full service by the mid 1980s.) The CNET's first optical system used 3 km of Corning fibers and, after running for some 20 months at 2 Mb/s, has been modified to accept data at 8.4 Mb/s. Now the CNET also has parts of a 3.4-Mb/s system working and hopes to have firm specifications for its first trial system by early 1978, with operation starting in 1980.

Nor have the military, back in the U.S., been idle. All three services were from the beginning attracted by the small size, light weight and freedom from interference of optical fiber—all major concerns aboard aircraft or ships or for secure tactical and strategic links under water or on land. The Navy and Air Force naturally concentrated on data busing for signal transmission in aircraft and on ships, while the Army is concerned mostly with secure land communications links.

More specifically, a fiber-optic sonar link recently underwent trials aboard a submarine [*Electronics*, May 27, p. 39], while a fiber-optic telephone system has now operated without failure in the fiber-optic portion for three years aboard the U.S.S. Little Rock. "Fiber installations have proved very successful," sums up Don Williams, program manager at the Naval Electronics Laboratory Center in San Diego.

Williams estimates that the 450 pounds of copper wire now used in fighter aircraft could be replaced with only 50 pounds of fiber cable. In the Navy A-7 aircraft, for example, 13 optical-fiber cables have supplanted 115 wire signal channels representing 302 separate conductors, almost a mile of electric cable being replaced with only 224 feet of fiber. Williams also points to the fiber-optic link used between antenna and transceiver of the AN/PPS-18, a general battlefield-surveillance radar. "If funding comes through, this would be the first military system to go into production using fiber optics."

As for the Army, its budget for fiber-optic development in fiscal 1977 has increased "significantly" over last year, according to Larry Dworkin, acting chief of advanced techniques at the Army Electronics Command, Fort Monmouth, N.J. He points to several contracts they are close to letting—one for field-deployable optical-fiber cables for use in ground tactical and strategic telecommunications, and another to develop connectors for six-fiber cables that can withstand the rigors of military environments.

According to Dworkin, RCA has a contract with the Combat Surveillance and Target Acquisition Laboratories to investigate high-radiance light-emitting diodes and lasers operating in the

820-nanometer range that is typical of fiber-optic systems. He also adds that the Army is about to embark on its first major production-type commitment—an investigation of methods of manufacturing light sources (LEDs and lasers) and photodetectors (silicon p-i-n diodes and avalanche photodetector devices).

Meanwhile, the Air Force is developing, among other things, multiple fiber-optic systems with optical switching at data rates of less than 50 Mb/s.

## Great growth

It's as a result of this kind of work that fiber optics has aroused industrywide interest. Individual applications, particularly in computers, will be described later. Overall, so encouraging are the signs that Gnostic Concepts Inc., a Menlo Park, California-based market-research firm, is predicting that the world market for fiber-optic systems will grow to over \$1.58 billion by 1990. Jeff D. Montgomery, Gnostic's vice president, foresees initial growth in applications where the unique advantages of fiber optics justify its slightly higher price. But within the next decade or so he predicts an explosive growth in the use of optical components in production systems. "In the U.S. this number should reach \$64 million by 1980 from a little over \$1 million in 1975, and should jump to \$833 million by 1990," says Montgomery. At that time he sees the major markets as follows: commercial communications will account for 74% of those applications, up from 54% in 1980; commercial computers, although dropping from 17% in 1980 to 9% in 1990, will have a much larger volume, and the market for industrial process control will remain steady at 7%, but again this will account for increased dollars.

Martyn F. Roetter, technical director of Arthur D. Little Inc.'s program on optical technology and markets, pretty much agrees with the major growth areas singled out by Montgomery. However, he points out that much of what happens worldwide

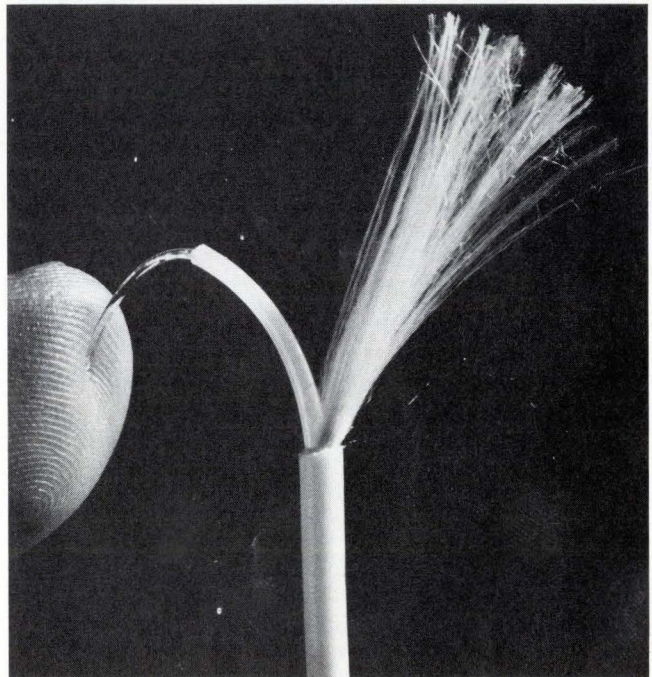

**2. Flexible fiber.** Although most people think of thin glass fibers as extremely brittle, Du Pont's new pure-silica-core fibers illustrate the toughness possible—this 8-mil-diameter cabled fiber does not break even when bent in a radius of less than 0.125 inch.

will depend on the policy set by Bell in the U.S. and the telephone companies overseas. He thinks it will be 1981 before Bell is sufficiently convinced that fiber cables in the ground can last 20 years and implements such systems. However, he does see new computers introduced within the next several years and industrial control systems as nearer high-growth areas.

As part of its investigations, Arthur D. Little is developing digital and analog optical-fiber communications systems to carry voice, data and video signals for short-haul use. This the firm sees as the most promising near-term application of fiber optics. "We feel that the benefits and applications of the technology cannot be realized without a greater understanding and experience in design, construction, testing and total costing of such systems," says Herb Elion, Arthur D. Little's program manager. And, one might add, greater understanding and experience of the components of fiber-optic systems.

### The components

Even though light sources and detectors, splices and connectors are essential elements in fiber-optic communications, it's been the optical fiber that has paced its progress. And only as the cost of the fiber becomes competitive with existing coaxial cabling, will fiber-optic technology really catch on, whether in systems that must perform well in high-voltage areas or in instrumentation linking remote sensors with central processing units, whether within mainframes of computers or in linking computers to peripherals in noisy environments.

For some high-performance applications even now, optical-fiber cable is preferable to existing coaxial transmission systems. For example, presently available coaxial-cable loss in a 100-Mb/s-system can be as high as 30 dB/km, whereas for the same bit rate a graded-index optical fiber has a loss of about 5 dB/km. Low-loss optical fibers with increased bandwidth capability in lightweight cabling make them ideal for communications links where crowded cable ducts now pose a problem—the lower signal attenuation allows longer cable runs before any signal processing is needed. In weight-sensitive applications, over a ton

### Fiber optics in the car

Fiber-optic communications systems are not only immune to the high noise levels of automobiles—they can reduce cabling harness weights, material cost, and processing time. An experimental fiber-optic harness system has been developed by General Motors Engineering to transmit vehicle control signals over a single-optical-fiber link, instead of over conventional wires. Such a system, perhaps built into the steering column or into a modified turn-signal control arm, would transmit separate signals over the fiber to an optical receiver, which would then convert them into electrical signals so as to switch on headlights or control turn signals, windshield wipers, and the hazard blinker. Such a system, once it passes the experimental stage, should open up a tremendous market for fiber optics.

of wire cables can be replaced with fiber cables weighing less than 1% of that. Moreover, wherever miles of cable are used in conjunction with low-level digital signal transmission, electromagnetic interference becomes a horrendous problem. Here, interference-free optical fibers eliminate the costly transformer isolation and cable shielding needed for conventional wire conductors.

### Different direction

With the rapid progress being made in fiber-optic technology, attention is shifting from the more theoretical aspects to operational and manufacturing problems. For example, the emphasis is now less on reducing the loss of fibers and more on the production of fibers with tighter tolerances and low-cost cables that are rugged in the field. A number of good, low-cost p-i-n detectors are already available, but the development direction is toward low-voltage avalanche photodetectors for more demanding applications. Still missing are economical light sources with long life, which are essential to all potentially major users, especially the telephone companies.

And one of the biggest problems is the scarcity of inexpensive yet reliable single-fiber-per-channel connectors suitable for use by unskilled workers in the field. Within the last year both metal- and plastic-shelled connectors have been available for bundle fibers, but only recently have commercially available single-fiber-per-channel connectors surfaced. These connectors are designed to couple fiber to fiber, fiber to source, and fiber to photodetector.

### Setting standards

With the very small diameter of single fibers, connector tolerances in the order of 0.1 mil are required to keep losses low. This, in itself, creates production problems, but with fiber and cable dimensions not yet tight enough and the proliferation of different fiber sizes from many different manufacturers, most connector makers feel they cannot design inexpensive, practical devices until the fiber makers get together on some standard. That would have to involve companies such as Corning, ITT, Galileo, Valtec, Fiber Communications Inc., Du Pont, Polyoptics, and Fiber Optic Cable Corp., as well as several overseas suppliers.

Sets of standards, in fact, are needed for all fiber-optic components, not just for fibers and connectors. Several agencies

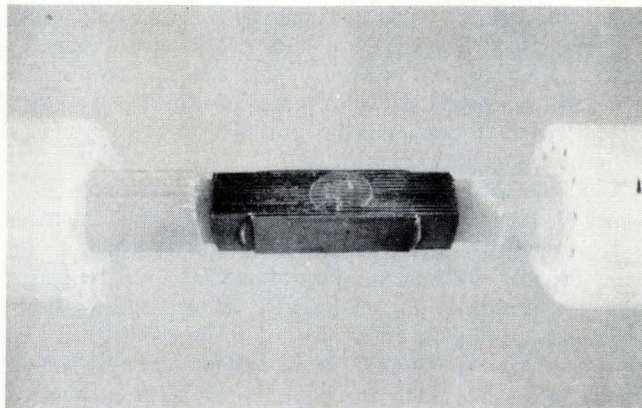

**3. Atlanta connection.** Cable connectors used in Bell's optical-fiber experiment interleave layers of precision-grooved aluminum chips (dark areas) with rows of fibers. The complete splice accurately aligns all 144 fibers in each cable.

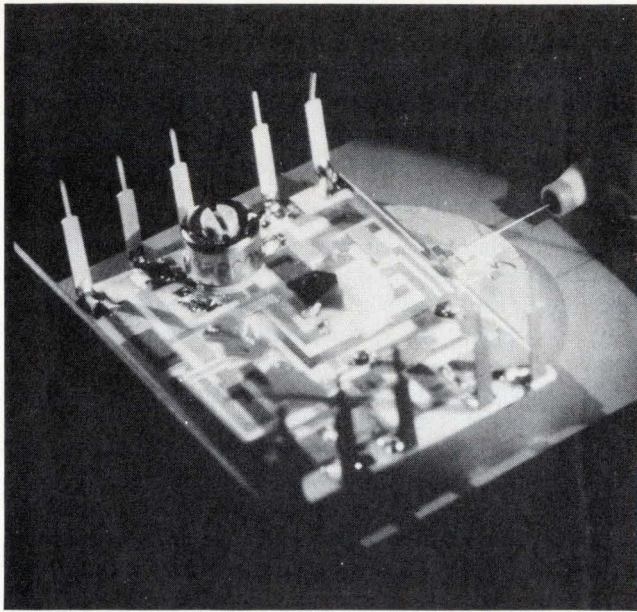

**4. Light coupling.** The tiny optical fiber can be seen as it enters the Bell Laboratories' experimental transmitter module. The light generated by the source is coupled with not only the fiber but also a feedback circuit on the substrate to maintain constant output.

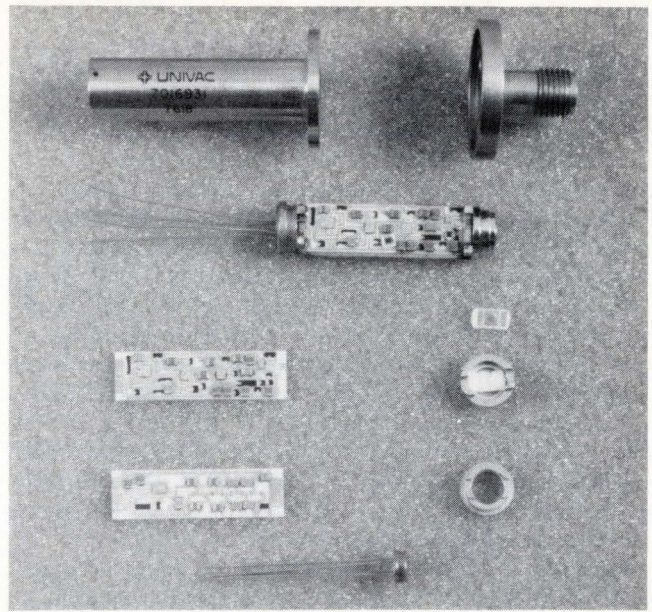

**5. Matched pair.** Sperry Univac's fiber-optic receiver and transmitter were designed to replace existing wire transmission systems. The receiver shown uses hybrid circuitry on substrates; p-i-n photodiode mounts in a conical ferrule that attaches to the substrates.

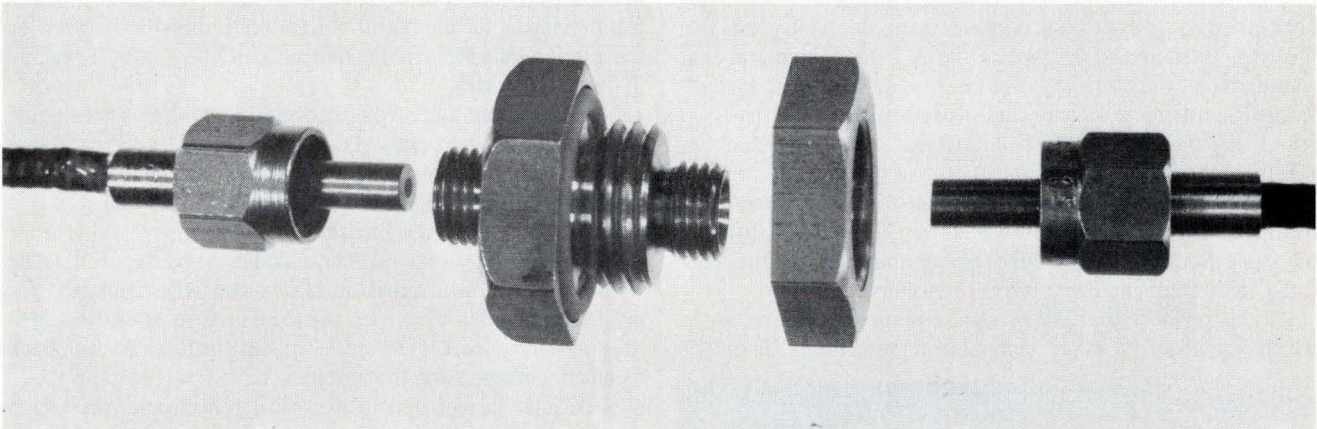

**6. One of a kind.** The first optical-fiber connector to be MIL qualified was developed by the Naval Electronics Laboratory Center for use with fiber-bundle cables and is fully compatible with other fiber-optic components and hardware under development by the Navy.

have groups working on the problem. The Electronic Industries Association, Washington, D.C., has a task force concerned with all phases of development and trends in fiber-optic terminations and junctions. This group, chaired by Philip Dann of IBM Federal Systems, Oswego, N.Y., is committed to meeting the Department of Defense's goal of having standards available by 1980. And DOD itself has in operation a tri-service group working to develop standards for all the services for fiber-optic systems.

At the Society of Automotive Engineers, too, another group is developing test procedures for optical-fiber cables. Under the guidance of W.D. Watkins of the Naval Avionics Facility, Indianapolis, Ind., this group will supply information to DOD to enable it to issue preliminary military specifications on optical-fiber cables in 1977. There is close liaison among groups.

As for sources, reliability is also a headache. For practical optical-communications applications, their lifetimes should reach at least 100,000 hours and, although extrapolated test data for both lasers and LEDs points to this being possible, the big

question is when. Work on the problem is in progress at Bell Labs, which has the formidable task of developing practical long-lived lasers for the Bell System's greater-than-20-year life requirements. And such companies as RCA, BNR, TI, HP, ITT, Monsanto, Spectronics, Laser Diode Laboratories, Plessey, GE, and Fairchild are among those that have LED and laser sources commercially available.

#### The cost factor

Second only to the need for standards is the problem of cost. A major contractual commitment to a large-scale system or systems needs to be made, whether by Bell, IBM, or the military, since otherwise it's likely that practical components will remain expensive and not widely available.

The cost of today's fiber-optic components doesn't reflect what could happen in a volume business. A go decision by the telephone company, for instance, would trigger a tenfold shift downward in the cost of fibers, says Charles J. Lucy, general

manager of the Telecommunications Products division of Corning Glass Works, Corning, N.Y. "Graded-index fibers with under 5-dB loss and greater than 500-MHz bandwidth could cost as little as 5 cents per meter in 500,000-km lengths in about five years," claims Lucy. This is close to the cost of cabled copper wire today, and the cost of copper is certain to have risen by then. And Richard A. Cerny, marketing manager for advanced fiber communications at Valtec Corp., West Boylston, Mass., thinks there will be sufficient demand by 1978 to bring prices down to around 25 cents per meter for cabled low-loss fiber channels. Prices now range from about \$1.50 to \$2.50/m of graded-index-fiber cable in quantities of up to 50 kilometers. Step-index fibers are less expensive.

According to Martyn Roetter of Arthur D. Little Inc., lasers could drop similarly to about \$25 each in production quantities of 100,000. He bases this prediction on what has happened with other microwave devices.

The Navy's Don Williams is in full agreement with this kind of thinking. "It will not be long before we can compare fiber and wire costs on a foot-by-foot basis," he says. But even now, he emphasizes, optical fiber is economically superior if the larger perspective of life-cycle costs is taken into account. He points to a life-cycle/economic study, part of the A-7 Aloft program, that considered all the tradeoffs involved in using fiber-optic systems as against twisted-pair wire and coaxial-cable counterparts. It found that the optical-fiber bulkhead and cable connectors are not only half the cost of equivalent coaxial terminations, but the assembly time of optical fiber-cable and connectors takes 30% less time than with coaxial components. This included stripping the cable from the fiber bundle, gluing and polishing the fiber ends, and assembling the cable to connectors.

All this performance and cost data adds up to a technology in which just about all major computer manufacturers should be

interested. And they are. Optical fibers offer them the large bandwidth needed to move massive blocks of data at high speeds and then throw in small size and weight, too. The ease of installing optical-fiber cable compared to multiple coaxial cables, along with its immunity to the large electromagnetic interference levels in and around computers, are other factors in its favor.

## The computer connection

Computer hookups need wires routed through conduit to prevent sparking, and it costs about \$4/foot to lay conduit. Fibers don't need conduits. In fact, no wiring changes are required to equip some existing computers with optical-fiber links.

Consequently, fiber optics will be widely used for interconnecting mainframes and peripherals. Moreover, the trend toward distributed data systems is certain to create the need for much greater bandwidth as numerous intelligent terminals, minicomputers and more memories are all interconnected. Initially, though, a computer could have a hybrid interface with one or two parallel coaxial lines and the remainder in serial fiber optics.

Du Pont, for instance, is looking into replacing the four-wire cable and conduit connecting two Digital Equipment Corp. PDP-11 minicomputers with two optical-fiber channels.

And Sperry Univac's Fiber Optic/Hybrid Component Development Group at St. Paul, Minn., is looking into using the miniaturized fiber-optic digital transmitter and receiver modules it is developing for the Naval Electronics Laboratory Center for the interface of peripheral equipment with fiber optics, especially in display terminals.

(The bulkhead-mounted fiber-optic modules, incidentally, were designed as part of the Tri-Service Technology Program on standard fiber-optic components. The modules mate with standard optical-fiber cables and connectors developed under NELC's Fiber Optics Technology Program.)

Both transmitter and receiver modules were designed to be compatible with TTL signal interfaces and were packaged for bulkhead mounting to replace twisted-pair wire or coaxial-cable transmission systems. The receiver module includes back-to-back mounted substrates for the amplifier circuitry. The p-i-n diode photodetector is mounted in a conical reflector ferrule which attaches to the substrates. The other end mates with an optical-fiber cable. The transmitter module is physically similar to the

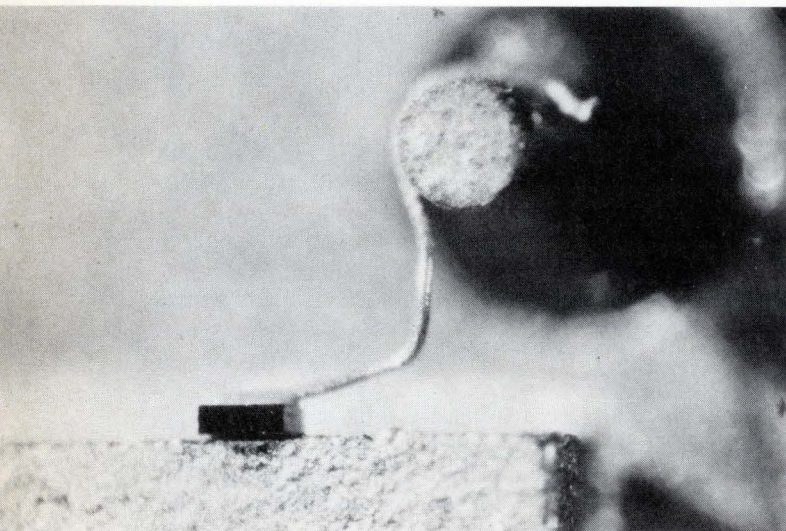

**7. Tiny sources.** RCA's experimental continuous-wave gallium-aluminum-arsenide laser diode is shown mounted on a TO-46 header. The laser chip is attached to a metal block to dissipate heat and is connected to the header pin by a small wire.

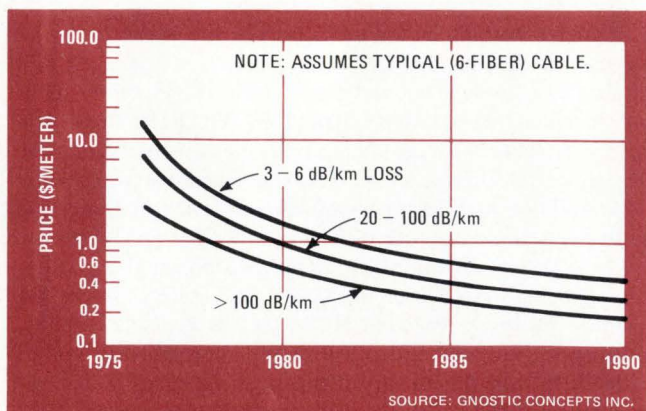

**8. Downward trend.** The cost of all single-fiber-per-channel cable will continue to drop. For instance, by 1990 a typical six-fiber cable with an attenuation of from 20 to 100 decibels per kilometer should cost less than 30 cents per meter—down from about \$6 today.



receiver. It uses a hybrid driver circuit mounted on ceramic substrates and, for military environments, is hermetically sealed in a cylindrical case similar to the receiver's.

Many overseas companies are thinking of fiber optics in terms of high-capacity telecommunications lines. U.S. companies are more inclined to look at fiber-optic links as replacements for short-haul trunking and lower-priced communications systems now, although eventually they will displace existing high-capacity lines as well. But at present, the main thrust is towards telecommunications applications like interoffice trunking and commercial applications like short-haul data transmission between computer peripherals, machine tools, and programed instruments.

### Other applications abound

One such system designed by AEG-Telefunken of Germany, called V300P, is already on the market [*Electronics*, Feb. 20, 1975, p.40]. And a follow-up system intended for high bit-rate color-TV signal distribution within large apartment buildings is in the works. Other applications for the system are to link computers and peripherals, to distribute CATV signals, or to carry signals from sensors to a process-control computer.

In England, Rediffusion Engineering Ltd., a TV rental and distribution company, last April installed what it claims is the first operational fiber-optic link carrying live traffic over a 1.5-km stretch of two-fiber cable buried in the pavement and grassland at Hastings, Sussex. The cable carries two full-bandwidth color-TV channels amplitude-modulated on the lower sideband of an 8.9-MHz carrier, the same signal as is used by the company for normal coaxial-cable traffic. "It's serving 34,000 subscribers and has been working constantly with no deterioration of anything," says Kenneth C. Quinton, the firm's director of research.

In Japan, fiber optics is being considered for telecommunications applications and has actually been used to control power facilities. The cables are threaded through tunnels containing high-voltage power lines and will replace microwave systems whose signals are often blocked by tall buildings and the like [*Electronics*, Aug. 7, 1975, p.45]. Nippon Electric Co. Ltd. carried out a field test recently in the high-voltage power station in Tokyo.

To round out the list, an experimental optical-fiber communications link is planned for the city of West Berlin jointly by Germany's post office authorities and ministry for research and technology [*Electronics*, Nov. 13, 1975, p.56].

### Off the shelf

Within the last year analog and digital fiber-optic systems have been offered by many companies, such as ITT's Electro-Optical Products division, Roanoke, Va., and Harris Electronic Systems division, Melbourne, Fla., not to mention Meret Inc., Santa Monica, Calif., Spectronics Inc., Richardson, Texas, Bell Northern Research, Ottawa, Canada, Valtec Corp., West Boylston, Mass.

Typical examples come from ITT and Harris. ITT's system is capable of data rates of up to 25 Mb/s over several hundred feet. Input and output are TTL-compatible with amplitude-regenerated data out. The analog system has one wideband channel, plus two narrowband channels that are fm-multiplexed onto the wideband channel so that only one optical channel is needed for transmission. Harris's 32-channel digital data link, on the other hand, is geared to computer-to-peripheral installations of up to

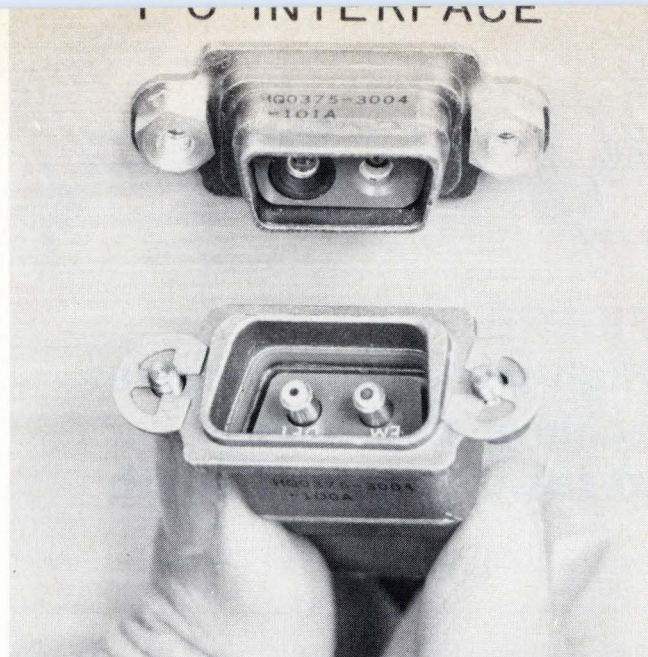

**9. Two-way.** The bulkhead side of Spectronics' optical-fiber plugable interface connector houses both the light-emitting-diode source and p-i-n photodiode detector needed to send and receive signals in a duplex fiber-optic transmission system.

1,500 feet at data rates of 16 Mb/s.

Perhaps Charles P. Sandbank, manager at the advanced Communication Systems division of Standard Telecommunications Laboratories, Harlow, Essex, England, sums it up best. "Fiber optics was once a matter of 'if to' and 'when,' but it will soon be a matter of 'when' and 'how much'." Worldwide commitment is very great indeed. And the rugged low-cost fiber cables and other needed optical components are just about here to support the accelerated growth that's now happening. It's therefore important that design engineers become familiar now with all available components for such systems.

### The necessary knowledge

It's partly the sheer unfamiliarity of fiber optics, in fact, in addition to its still rather high cost and the lack of standards, that is delaying the widespread adoption of this exciting new communications technology. Potential users need a better understanding of what fiber optics can do for them, and system designers need to overcome their resistance to change—much as an earlier generation did in making the switch from tubes to transistors.

To help remedy this state of affairs, the following nine articles will bring the engineer up to date in fiber-optic technology. They detail what's available in fiber-optic components and how to work with each of them. All are written by leading experts in their respective fields and have been structured to give the engineering community an in-depth, timely perspective on fiber cables, light-emitting and laser diodes, connectors, photodetectors and optical coupling techniques.

Subsequent issues of *Electronics* will include articles that focus on the systems design considerations with fiber optics. They will translate user specifications into systems, and their focus will be on the steps needed to specify optical fibers and components that best fit the overall requirements for both analog and digital fiber-optic communications systems.

Reprints of this Special Report, including the following nine articles, will be available at \$3.00 each. Write to Electronics Reprint Dept., P.O. Box 669, Hightstown, N.J. 08520. Copyright 1976, Electronics, a McGraw-Hill publication.

## FIBERS

# High-performance cables achieve zero failure at rated tensile strength

by R. Love  
Corning Glass Works, Corning, N.Y.

Optical waveguides have come far since 1970, the year in which fiber attenuation was finally brought within range of high-speed data-transmission requirements. Today, some commercial large-bandwidth graded-index fibers achieve an attenuation of only 5 dB/km—a quarter that attained in the laboratory six years ago. In the meantime, light sources have also been improving, and by now it seems generally agreed that single-fiber system configurations represent the best cost-performance tradeoff for most applications.

A rugged optical-fiber cable with six single fibers introduced in 1975 proved cost-competitive with coaxial cables in a number of communications applications and, in many cases, offered much better system performance. Now second-generation single- and multiple-fiber cables reduce incremental fiber attenuation due to cabling to less than 2 decibels per kilometer and, for the first time, are warranted for zero failure at the rated tensile strength. The important parameters of several optical fibers recently introduced by Corning Glass Works are listed in the table.

### Starting from strength

Glass is inherently much stronger than metal—tiny strands of glass theoretically can withstand tensile loads upwards of a million pounds per square inch of cross section. But in field use, glass has seldom revealed much more than a hundredth of the fracture strength predicted

of it. This strength, it has now been determined, is severely limited by the presence of infinitesimal surface flaws, and fracture always involves two independent processes: flaw initiation, and flaw propagation. Because of the random nature of flaw depth and spatial distribution, the probability of failure for a glass fiber depends upon its length. Also, since failure always occurs at the weakest flaw, or deepest crack, two seemingly identical fibers of equal length will not fail at the same stress level, or at the same time for an equally applied stress, unless the weakest flaws are also identical in depth.

In short, the strength of optical fibers, unlike that of copper wire, is an inherently statistical phenomenon. Therefore conventional strength parameters such as tensile strength or yield stress are not easily applicable to them.

A better approach is to characterize glass fibers in terms of their failure probability, by carrying out fast-fracture and time-to-failure experiments on a large number of fibers of the same gauge length. From the resulting data, failure probability for various combinations of applied stress, time, and fiber length can be derived on the basis of fracture-mechanics theory.

Alternatively, a minimum time to failure under constant load may be specified if fibers have been subjected to on-line screen testing. This involves applying a uniform tensile stress to the fiber at the time of manufacture and prior to final reeling. Survival of the screen test guarantees that no flaws greater than a certain depth exist in the final fiber, since otherwise failure would have occurred.

From the viewpoint of fracture-mechanics theory, screen testing sets the initial condition on flaw depth. If other material constants are known, the minimum time to failure as a function of applied stress can be calculated. Screen-test stress levels required to guarantee zero failure in 20 years are plotted as a function of service stress. This approach to characterizing fiber strength doesn't depend on fiber length. The long-term service stress for zero failure is analogous to the yield stress properties of copper wire in electrical cables.

### Microbends multiply losses

During the early phases of optical cable development, it was observed that numerous "microbends" (small axial distortions in fiber geometry) caused a significant

SOME SECOND-GENERATION OPTICAL FIBERS

Product No.	Index profile	Minimum bandwidth (MHz at 1 km)	Maximum attenuation, $\lambda = 820 \text{ nm}$ (dB at 1 km)	Core diameter ( $\mu\text{m}$ )	Numerical aperture ( $\pm 0.02$ )
1150	Graded	200	10	62.5	0.16
1156	Graded	200	6	62.5	0.16
1151	Graded	400	10	62.5	0.16
1157	Graded	400	6	62.5	0.16
1152	Graded	200	10	62.5	0.20
1158	Graded	200	6	62.5	0.20
1153	Graded	400	10	62.5	0.20
1159	Graded	400	6	62.5	0.20
1025	Step	20	10	85	0.18
1028	Step	20	6	85	0.18

Corguide fiber diameter ( $\mu\text{m}$ )  $125 \pm 6$       EVA buffer diameter ( $\mu\text{m}$ )  $250 \pm 25$

increase in fiber attenuation. Microbends tend to continually couple light energy back and forth between low- and high-order modes. The latter are more highly attenuated and may even be scattered out of the fiber entirely. Continuous axial distortions, as small as 1 micrometer in amplitude and spaced 1 millimeter apart, are sufficient to cause 20 dB/km of incremental attenuation.

(It is important to distinguish between this effect and the attenuation due to "bending" losses described on page 91. An occasional small-radius bend in a fiber

merely radiates out higher-order modes, occasioning a low, one-time loss. Provided light energy is not coupled back into these modes, no further increase in attenuation will result when additional bends are encountered.)

To minimize microbending losses, optical cable is designed to mechanically isolate the fibers from small material or geometrical irregularities in the cable structure. In this, the new second-generation optical cables are particularly successful—any of the fibers listed in the table can be cabled with less than 2-dB/km excess attenuation. They are encapsulated in ethylene vinyl

## Looking into fibers

Although three types of fiber exist—single-mode, step-index multimode, and graded-index multimode—only the last two have gone public. Single-mode fibers can propagate optical signals with a very low loss at extremely large bandwidths but are still in the research stage.

Of the other two, the less costly step-index fiber consists of a glass core of uniform refractive index surrounded by a cladding glass of slightly lower index of refraction. The more costly graded-index fiber has a core with a refractive-index profile that is radially symmetric and approximately parabolic in shape, being highest at the center of the core and decreasing parabolically till it matches the cladding refractive index at the core-clad interface.

Light launched into the core of either fiber at an angle less than the critical acceptance angle (numerical aperture) is reflected internally upon striking the core-cladding interface and therefore continues to propagate within the fiber core.

In both step- and graded-index fibers, the light signal is carried in a large number of modes, each with a characteristic velocity and propagation time. Graded-index fibers, however, because they minimize the propagation delay differences between various modes, can handle large bandwidths. As a rule of thumb, commercially available step-index fibers can handle data rates of up to 50 megabits/km, and graded-index fibers up to 500 Mb/km. The as-yet experimental single-mode fibers are capable of

still greater things—more than several gigabits per kilometer.

As with electrical conductors, the signal-transmission properties of optical waveguides are characterized in terms of attenuation versus frequency. This transfer function depends on fiber attenuation (absorption and scattering) and signal dispersion (pulse spreading).

Both parameters depend in part on fiber materials. For example, absorption in the near-infrared portion of the spectrum is due mainly to OH radical vibration bands. On the other hand, Rayleigh scattering from the thermal fluctuations of constituent atoms is the primary scattering mechanism. Spectral attenuation curves include the effects of all these parameters.

The spectrum width of the light source and material dispersion in the fiber determine pulse spreading. For example, a 1-km length of a doped-silica optical fiber driven by light-emitting-diode with a spectral width of 50 nanometers exhibits a pulse spreading of approximately 3 nanoseconds. With laser diodes having spectral widths of about 2.5 nm, pulse spreading drops to about 0.3 ns.

To determine the transfer function of an optical fiber, attenuation and pulse spreading measurements are carried out on a standardized but arbitrary length, usually 1 km. The transfer function of an available Corning fiber results from superimposing the signal dispersion, which depends on frequency, on the fiber attenuation due only to scattering and absorption of light.

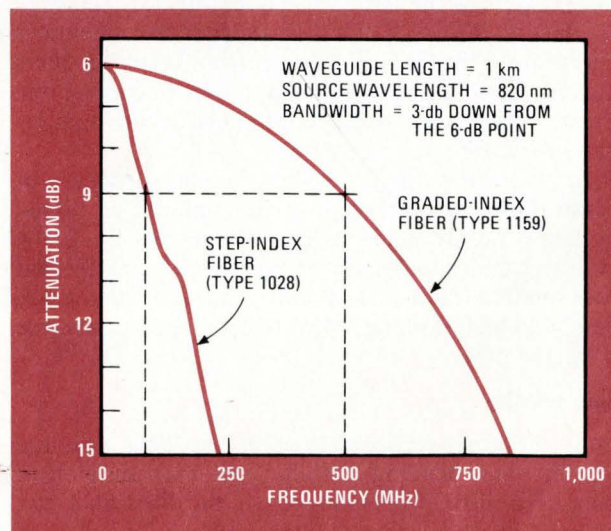
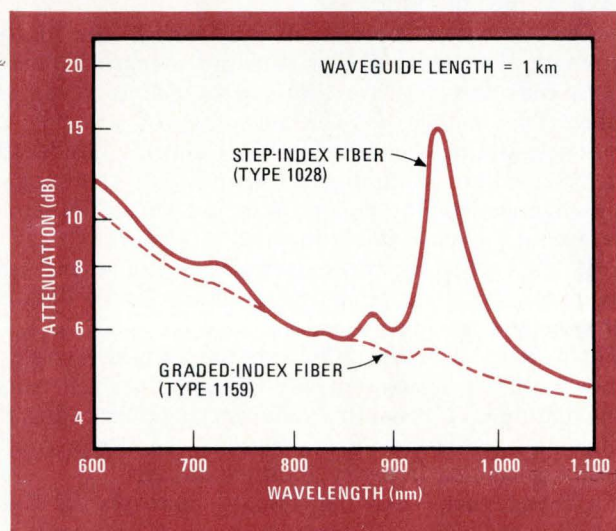

acetate to isolate them mechanically and buffer them against any small geometrical irregularities or distortions found in the jacketing or reinforcing components. The encapsulation also helps protect the fibers from damaging impact or abrasion during the reeling and handling operations. Their rated tensile strength is based on fiber screen-test stress, which may be derated with respect to time and applied load. As a rule of thumb, long-term (more than 20 years) tensile stress rating for zero failure is about one third of the fiber screen-test stress (Fig. 1).

Virtually any degree of tensile strength or crush resistance can of course be provided by appropriate reinforcing components and armoring. But just as in wire cables, ruggedness must be traded off against cable flexibility and cost.

#### Coax contrasted

Optical cables are installed in the ground in much the same manner as wire cables, except that a longer pull length for the same rated tensile strength is possible. For

example, Corguide cable can be pulled through straight ducts longer than 1 km. This is because frictional forces are proportional to cable weight, and optical cables of the same diameter as coaxial cables are approximately four times lighter.

Moreover, beyond bandwidth requirements of a few megahertz, graded-index fiber cables are far superior to all but the most expensive, largest-diameter, coaxial cables. And lower-bandwidth-capability step-index fiber cables outperform all but RG-17/U coax cables up to 100 MHz.

Also the dielectric nature of optical fibers makes them immune to electromagnetic interference. They do not conduct electricity, thus avoiding ground loop problems and offering a degree of transmission security. Moreover, in ordinary cable environments, optical cables show much less change in their transmission properties (attenuation, pulse distortion) than their metallic counterparts.

Performance data shows that optical cable is superior to coaxial cable on a single-channel basis, above a few megahertz. In addition, 10 or more fibers (channels) can be packaged in a single cable the size of RG-63/U with cross talk more than 80 dB down over a 1-km length. Cost on a per-channel basis now ranges between \$0.60/ft and \$2/ft for optical cables compared to \$0.15/ft to \$1.50/ft for coaxial cables.

## FIBERS

### Simple testing methods give users a feel for cable parameters

by R.B. Chesler and F.W. Dabby  
*Fiber Communications Inc., Orange, N.J.*

Mechanical as well as optical characteristics play an important part in the design of optical-fiber systems. In particular, it's necessary for the designer to understand how to prevent mechanical stresses from breaking fibers or causing too much attenuation and how to check cable parameters like tensile strength, attenuation, and numerical aperture.

The risk of breakage is perhaps the major concern of the optical-fiber user, though the availability of cabled fibers has certainly made it less of a worry. Basically, fibers break under too heavy an axial load or when bent in too small a radius. The two breakage modes are related, and determining one breakage point sets the level for the other.

#### Stress levels

From the cross-sectional area of the fiber and the minimum safe bending radius, the maximum load bearing capability of an unjacketed, uncabled fiber can be calculated. Increasing a fiber's cross-sectional area makes it stronger but also, by increasing its radius, r,

limits its minimum bending radius,  $R_{min}$ , before breakage. The relationship describing this tradeoff is:

$$S_T = E(r/R_{min})$$

where E is Young's modulus, typically  $10^7$  psi.

For an uncabled low-loss fiber, which consists of a core and cladding to protect the core material, a reasonable maximum tensile load-bearing level,  $S_T$ , is 50,000 pounds per square inch for about a 1-km length. The tradeoff of tensile strength with minimum safe bending radius usually limits the diameter of commercially available fiber to between 2 and 8 mils. A 3.5-mil uncabled fiber, for example, can be tied into a circle less than  $\frac{3}{16}$  inch in radius.

One common method of measuring the tensile strength of uncabled fiber is to clamp a length of fiber at both ends and measure the load needed to break the fiber. This method has the advantage of stressing the entire length of fiber between the clamps. Considerable care, however, is required to assure that clamping or misalignment of the clamps does not cause premature failure of the fibers under loading.

If the necessary stress-measuring equipment isn't available, an alternate approach yields usable data. In this method the fiber is tied into a simple overhand knot. Then, as the knot is tightened, the resulting circle is monitored. The minimum safe radius occurs just before the fiber breaks. From this value and the fiber radius the maximum tensile load-breaking ability of a fiber can be easily calculated from the above equation.

Cabling each fiber individually increases its load-bearing capability. At present, several materials are commercially available for cabling low-loss optical fibers

in fiber-bundle, multi-fiber and single-fiber cables. Currently, single-fiber cables with diameters as small as  $\frac{1}{20}$  in. can withstand tensile load-bearing levels of 475 pounds—better than some multiple-fiber and fiber-bundle cables.

Besides fiber breakage, bends cause losses. They increase the attenuation by reflecting out of the fiber core some of the many light modes that should propagate within it. As these modes encounter a region of bends in a fiber, they enter the core-cladding interface at a larger angle than the one critical for total internal reflection.

The leakage becomes more pronounced as a fiber-core diameter increases or as numerical aperture decreases. But reducing the core diameter to minimize bending loss results in less light being coupled to the fiber—coupling efficiency being proportional to the square of the core diameter. Increasing the numerical aperture also decreases bending loss, but reduces the information-carrying capacity of an optical-fiber waveguide.

In general, commercially available, low-loss optical fibers with glass core and cladding have numerical apertures of between 0.1 and 0.3. Commercial fibers with higher values of numerical aperture have higher attenuation, which in the case of glass-core, plastic-clad fibers, increases drastically in humid or watery environments.

### Flat finish

Optical polishing of fiber ends is used only for terminating fiber bundles (see p. 99 and p. 101). With single-fiber cable, cleaving the ends is fast and easy and all that's necessary. Properly cleaved surfaces are flat and perpendicular to the fiber axis and are well suited for coupling to sources and detectors or to other lengths of fiber.

The first step in cleaving a fiber end is to remove any cabling or jacketing material from 3 or 4 inches of fiber. Next the bare fiber is grasped at two points, about half an inch apart, between the thumb and forefinger of each hand. This half-inch section is held taut and gently

drawn across the hard edge of a suitable scribing surface, such as a sapphire crystal, so as to scratch the glass fiber but not break it. Then a gentle tug will snap the fiber at the scratch. The fiber must be pulled straight without any bending.

The quality of the cleaved surfaces is then checked under a microscope. A good cleave also produces a circularly symmetric output light pattern when light from the fiber viewed on a screen about a foot away.

The cleaving technique works well for fiber diameters up to approximately 5 mils. Fibers with larger diameters must be bent around a mandrel and cleaved under tension. Simple instruments and tools for fiber cleaving are available commercially.

### Looking for loss

Comparing the magnitude of transmitted light power at two points along a fiber waveguide eliminates the need for measurements of absolute optical power and light coupling efficiency. The typical setup shown in Fig. 1 makes it possible to determine the attenuation spectrum over an entire length of fiber.

Both ends of the entire length of optical fiber,  $L$ , to be evaluated are cleaved. One end is mounted in a movable holder, which is later adjusted to maximize the light input to it, and passed through a mode-stripping liquid placed near the input measuring point. Mineral oil or any other liquid with a refractive index close to that of the cladding (between 1.42 and 1.47) may be used. Doing this eliminates the unwanted "cladding" modes—those launched into the fiber because the numerical aperture of the input light beam is greater than the fiber's numerical aperture. This arrangement gives a fairly uniform illumination of all the desired fiber waveguide modes.

The other end of the fiber is placed into an output holder near a detector located in a light-tight chamber. The fiber holder at the input end of the length of cable is then adjusted to maximize detector current as read on the nano-ammeter, and the maximum amount of photo-detector current for each wavelength of interest selected

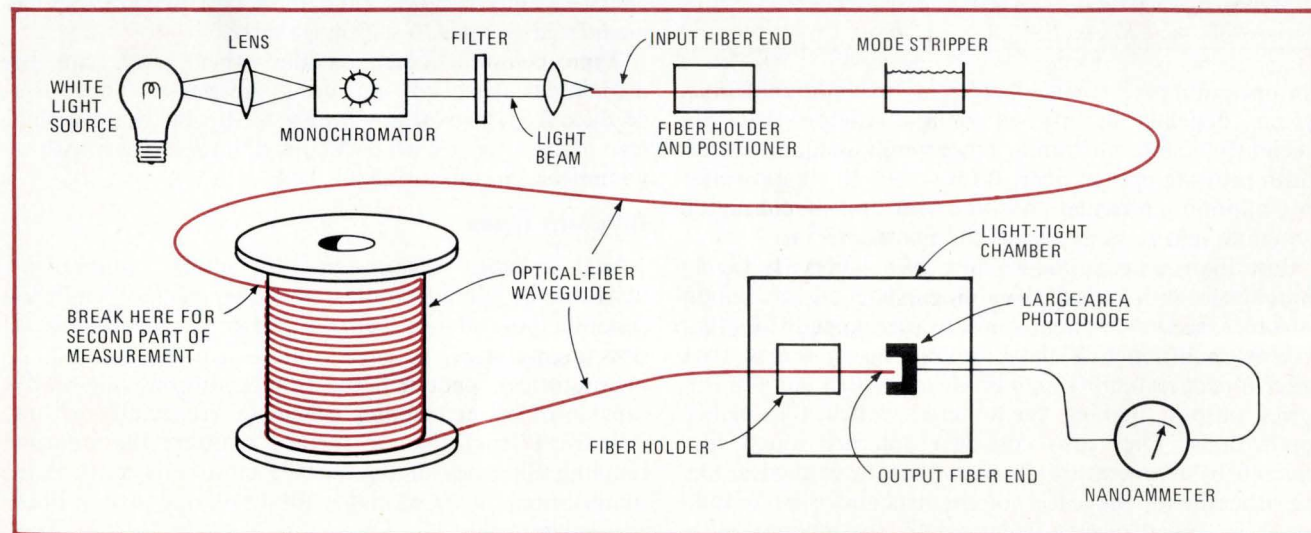

**1. Finding fiber loss.** This test setup makes it possible to find the attenuation of a long length of fiber directly, without having to worry about measuring either the absolute optical power of the source or the efficiency of the light-coupling arrangement.

by the input monochromator is recorded.

To obtain a consistent set of maximum readings at the desired wavelengths, several readings must be taken, with the fiber being re-cleaved at the detector end after each reading to eliminate inaccuracies caused by bad cleaves, dust particles on the fiber end, etc. Isolated low readings will occur because of imperfectly cleaved fiber ends, and these should be discarded.

The fiber is then cut about 3 meters from the input end of the fiber without disturbing the positioning of the input end so that the same coupling is maintained. The cut end of the 3-meter-long section is then cleaved and placed into the output fiber holder. Again, measurements at other wavelengths of interest are repeated to obtain another set of consistent data. From these two sets of data, the attenuation,  $A$ , expressed in dB/km, of the entire fiber length less 3 meters is calculated for each wavelength:

$$A = (10 \log_{10} f) / L$$

where  $L$  is the final length of fiber in kilometers less the 3-meter section that was cut from the initial length of cable, and  $f$  is the ratio of the measured input optical power to the measured output optical power of any

particular wavelength of light. For cables longer than several hundred meters,  $L$  can be assumed to be the initial cable length.

The numerical aperture of an optical fiber waveguide describes the maximum angle about the fiber axis through which light can propagate in the fiber. It is defined as the sine of the half-cone angle of the rays measured in air, and it generally varies with fiber length, because of fiber attenuation characteristics that modify the initial distribution pattern of the light.

#### Numerical-aperture measurement

Most manufacturers specify the numerical aperture of low-loss fibers by measuring the radiation pattern of a 3-meter-long fiber with all modes excited. This can be done simply and without elaborate equipment. The fiber is excited in the visible region, and the light emerging from the end is displayed on a screen placed several inches to a foot away. A solid circle of light is seen if all fiber modes have been excited; if not, a ring of light results.

Since the boundary of the circle of light is not perfectly sharp, some convention for determining the edge must be adopted. A common choice is the point where the light intensity is 10% of the maximum value. Actually the eye makes a good discriminator, and all that need be done is to measure the diameter or the circle of light with a ruler. Dividing that number by twice the distance from fiber end to the screen gives the value of numerical aperture.

## SOURCES

### High-radiance LEDs have linear response to analog inputs

by F.D. King

*Bell Northern Research, Ottawa, Canada*

For optimum performance, a fiber-optic communications system depends heavily on a light source that can efficiently couple maximum power with adequate bandwidth into the optical fiber. Its wavelength should suffer only minimum attenuation in the fiber and should match the maximum responsivity of the photodetector.

Both light-emitting diodes and laser diodes are highly compatible with doped silica fibers and silicon photodetectors, so the decision which to use depends on other system requirements. LEDs, unlike laser diodes that suffer modal instability, can produce a much more linear power output, making them better suited for analog applications. They also cost less and are much less affected by temperature changes than laser diodes. On the other hand, they are not as fast, and their output power is spread over a wider angle, so that less of it succeeds in entering an optical fiber.

To be more specific, gallium-aluminum-arsenide LEDs

produce light at high efficiency (10%) at an 840-nanometer wavelength where the attenuation of silica fiber is as low as 2 decibels per kilometer and the responsivity of silicon photodetectors is a high 0.55 ampere/watt. Their output power is 5 to 20 milliwatts either in a 120°-by-40° beam (edge-emitting type) or in a lambertian pattern (surface-emitting type). Fiber coupling loss is high—for a fiber with a numerical aperture of 0.14, losses are about 14 dB for edge emitters and 19 dB for surface emitters. Only the best (and most costly) LEDs can be modulated at rates of 200 megahertz.

Typical laser diodes, on the other hand, can be modulated at speeds up to 1 gigahertz. They also produce from 5 to 20 mW over a 40°-by-10° beam with a loss of about 3 dB when coupled into a fiber with a numerical aperture of about 0.14.

#### Different types

High-radiance LEDs designed for optical communications are, as already indicated, either surface emitters (usually those of the "Burrus" type first developed at Bell Laboratories) or edge emitters (developed at RCA Laboratories). Although the edge emitter is inherently capable of better coupling efficiency (especially with a cylindrical lens) than a surface emitter, the inferior coupling efficiency of the surface emitter is more than compensated for by its higher total radiated power. Both are shown in Fig. 1.

The most promising use a double-heterojunction design, being fabricated by sandwiching a thin active

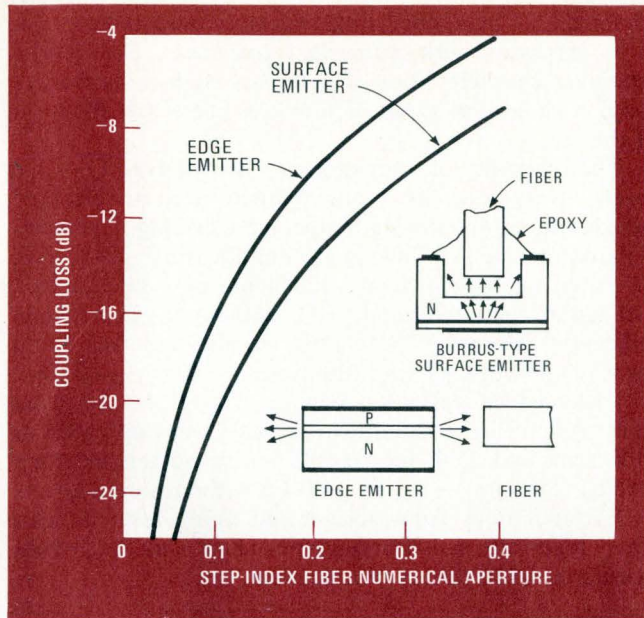

**1. Charting coupling loss.** Power coupled from a LED into an optical fiber depends on the numerical aperture of the fiber. Typical LEDs produce light over very wide beam patterns that make the fiber's light acceptance angle and placement critical.

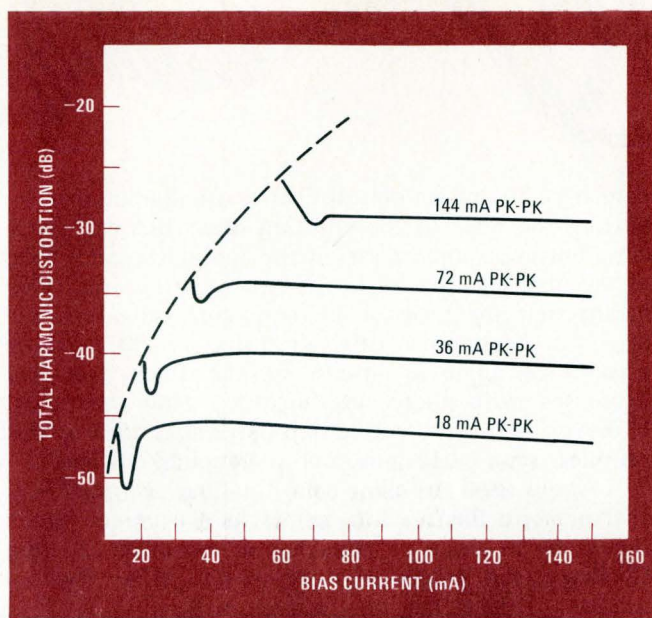

**2. Determining distortion.** Source linearity is very important in analog systems. From curves taken at different modulation depths for several BNR LEDs, it is possible to determine the optimum dc bias for minimum total harmonic distortion.

**TABLE 1**  
HIGH-RADIANCE LED CHARACTERISTICS

BNR device	External quantum efficiency (%)	Radiant intensity (at 150 mA dc) mW/sr	Response time (10-90%) (ns)	3 dB electrical bandwidth (MHz)	Spectral half width (nm)	Max. power launched into 0.2 numerical aperture step-index fiber, 150 mA dc (mW)
(A)	7	3	14	25	40	370
(B)	4.6	1	4	88	45	250
(C)	2.3	2	7	50	45	125

**TABLE 2**  
COUPLING CHARACTERISTICS OF HIGH-RADIANCE LEDs

Characteristic	Fiber			
	BNR 7-1-A	BNR 7-2-A	Corning	BTL
Numerical aperture	0.20	0.22	0.19	0.22
Core diameter ( $\mu\text{m}$ )	100	100	85	50
Type	Step	Graded	Step	Graded
Coupled power ( $\mu\text{W}$ )	370	280	340	140

Current density = 4.5 kA/cm<sup>2</sup>    Emitting area = 65  $\mu\text{m}$  diameter

layer of gallium arsenide between two layers of GaAlAs that absorb no energy and (in the case of edge-emitter types) act as light guides. The peak emission wavelength of double-heterojunction GaAlAs LEDs can be varied from 850 nm to 780 nm by increasing the aluminum content with no significant change in device efficiency. This allows the system designer to match fiber and source for minimum attenuation. Both peak emission wavelength and half-power spectral width show little change with drive current.

On the assumption that a fiber-optic-system designer opts for a LED source, the best device depends not only on total coupled power but also on speed, reliability, spectral width, cost, and (in analog applications) linearity.

### Tradeoffs

Harmonic distortion curves are shown in Fig. 2, and other performance characteristics of typical high-radiance LEDs are listed in Table 1. The three devices illustrate the tradeoff between efficiency and speed of response. Device A is optimized for total light output

and device B for speed of response, whereas device C represents a compromise between the two. By reducing device capacitance, LEDs with response times of less than 2 ns have been fabricated.

These devices all have nearly linear light-versus-current characteristics up to 250 milliamperes in continuous operation and a 1-ampere, 10-microsecond pulse in pulsed operation at 10<sup>5</sup> pulses per second. The temperature dependence of the light output of these devices is typically 0.2% per °C.

In wideband communication over long distances, chromatic dispersion in the fiber may limit repeater spacing. Because the velocity of light varies with wavelength, the different spectral components separate out as the light propagates down the fiber. The optical bandwidth-length product at which this effect becomes significant is determined by the spectral width of the light source. The spectral half-width of a typical BNR LED, for example, is 35-45 nm at 840 nm. This would limit the optical bandwidth-length product to 100-140 MHz-km.

The optimum coupling efficiency between a surface-

emitting LED and an optical fiber is usually obtained by butting the fiber to the emitting area. But extremely close butting is unnecessary if the light-acceptance cone of the fiber encloses all of the LED emitting area. This means that the ratio of source-to-core cross-sectional area can be optimized for graded-index fiber, whose acceptance angle is largest at the fiber axis and decreases with increasing distance from the axis. However, for a close-butted step-index fiber, making this ratio less than 1 does not improve coupling efficiency.

It would seem to follow from this that the numerical aperture of a fiber, which defines its acceptance angle, should be as large as possible, to maximize coupling efficiency. But values of more than 0.25 are seldom

practical in long fiber links because modal dispersion also increases with numerical aperture. The power-coupling characteristics of a typical high-radiance LED used with several types of low-loss fibers are shown in Table 2.

The reliability of high-radiance Burrus-type LEDs has been investigated at room temperature, at elevated temperatures, and during temperature cycling. Unencapsulated devices, following a qualification test, have operated for longer than 3,000 hours at 3 kiloamperes per square centimeter and 130°C without any decrease in efficiency. Moreover, no change in efficiency was noted over temperature cycling (20 cycles, -40° to +80°C).

Packaged encapsulated devices with fibers attached that passed further qualification tests were operated at 3 kA/cm<sup>2</sup> and 25°C for 10,000 hours and temperature-cycled (5 cycles, -30° to +30°C) without degradation.

Extrapolations from accelerated aging tests indicate that high-radiance Burrus-type LEDs should provide greater than 10<sup>5</sup> hours of operation.

## SOURCES

### Laser diodes provide high power for high-speed communications systems

by J.T. O'Brien  
RCA Electro Optics Division, Lancaster, Pa.

The trend to optical communications systems, "wired" with single fibers rather than bundles of fibers, puts a premium on the efficient coupling of source power into the fibers. The smaller optical aperture of the single fiber requires not only the higher source power of the laser diode but construction techniques that attach the fiber directly to a laser pellet. Meanwhile, laser diodes have their uses in high-speed, high-power systems using both fiber bundles and single fibers.

#### Two types

Gallium-arsenide and gallium-aluminum-arsenide laser diodes are available in single- and double-heterojunction structures. The double-heterojunction diode consists of a thin active layer of gallium arsenide, usually lightly doped with aluminum, sandwiched between two layers of GaAlAs. The single-heterojunction type has only one layer of GaAlAs along with the active layer of GaAs or GaAlAs. But the most important difference between them is the much higher data-rate capability of the double-heterojunction type (greater than 100 megahertz versus 100 kilohertz.).

Single-heterojunction laser diodes are low-cost, off-the-shelf items used in low-duty-cycle applications requiring high output power. Peak radiant flux of these diodes is limited to approximately 1 watt per mil of emitting-junction width at a 200-nanosecond pulse width. For example, a diode with a 9-mil-wide junction,

such as the RCA SG2007, is rated at a maximum of 10 w peak output. But because the diode's need to dissipate heat sets limits to its operation, a tradeoff between pulse width and pulse repetition rate must be made. Consequently, at a maximum pulse width of 20 ns and a maximum duty cycle of 0.1%, the repetition rate is limited to 5 kHz. At pulse widths on the order of 10 ns, repetition rates of 100 kHz are possible.

The double-heterojunction laser diode requires relatively low drive current and voltage (less than 400 milliamperes at 2 volts). Continuous or high-duty-cycle operation is possible at room temperature with power outputs in the 5-to-10 milliwatt range at less than 1-ns rise time. Analog or digital bandwidth capability exceeds 100 megahertz.

The semiconductor laser is essentially a line source with an emitting dimension of 0.08 mil times the emit-

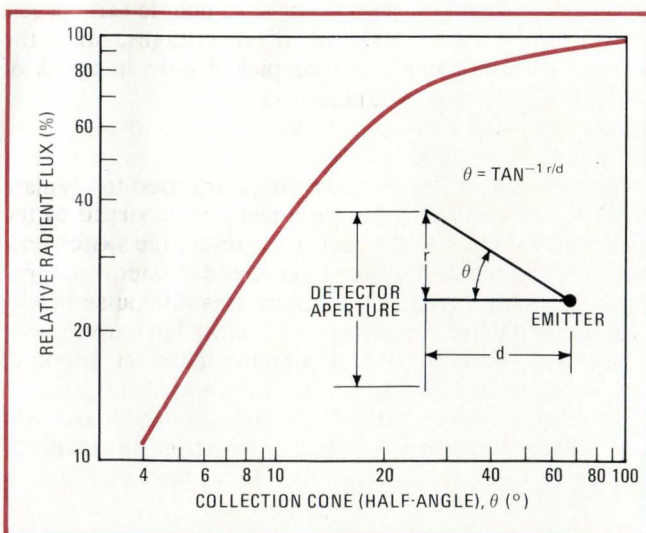

1. Collecting flux. The amount of light output from a semiconductor laser incident on an optical fiber can be determined from the relative radiant flux emitted by the laser and the fiber collection angle. Data for a single-heterojunction laser is shown.



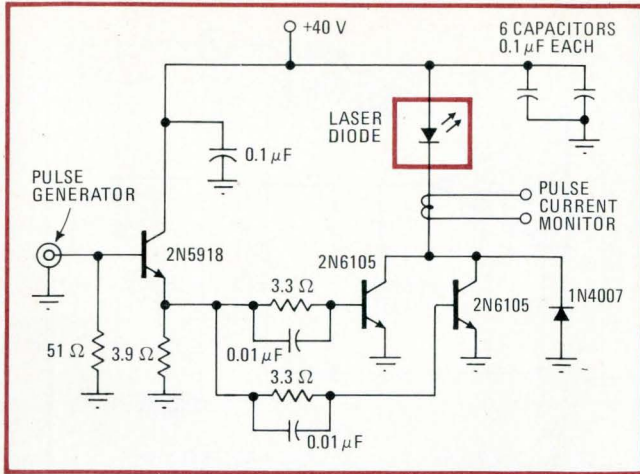

**2. Switching sources.** With the transistor circuit shown, pulses as short as 10 nanoseconds at repetition rates of 100 kilohertz are possible, but peak current is limited. Silicon controlled rectifier switches produce higher current but at lower repetition rates.

ting width. The wavelength of maximum intensity depends primarily on the bandgap energy of the material used and, to a much lesser extent, on junction doping. GaAs, for instance, has a center wavelength of 904 nanometers, which is temperature-sensitive. For a single-heterojunction type, the spectral bandwidth and half-angle beam spread at the 50% intensity points are 3.5 nm and 9° respectively. Both values are broad relative to other laser types and result in greater coupling loss to fibers.

The relative radiant flux collected at a detector depends on the collection angle of the laser diode. A typical curve is shown in Fig. 1.

For high peak output power, it is necessary to drive the laser with fast, high-amplitude current pulses. The pulse may be generated by discharging a capacitor through the laser using either a silicon controlled rectifier or a transistor. An SCR can switch higher peak currents than transistors, but at much lower speeds. Each has advantages and disadvantages, and the optimum drive circuit can be picked only in terms of overall system performance.

### Drive circuits

In SCR driver circuits, transistors are used to regulate the level to which the storage capacitor is charged by the supply voltage. The SCR acts as the discharge switch and, when triggered, drives the laser diode. General-purpose SCRs, such as 40763 or 40555, can handle pulse repetition rates in the range of 5–10 kHz. The capacitance value is determined by the combination of current and pulse width desired.

Not many commercially available SCRs are fast enough to deliver narrow, high-current pulses at repetition rates in excess of 10 kHz. But a few, such as the Unitrode GA-201, can generate 25-ns pulses at repetition rates up to 25 kHz.

With a transistor switching circuit (Fig. 2), pulses as short as 10 ns at repetition rates greater than 100 kHz are possible. The maximum peak laser drive current, however, is limited to approximately 20 amperes.

How much of the laser output actually enters a given optical fiber depends on cable as well as source parameters. From published data for a laser device, it's possible to determine what size gap there should be between it and the fiber face. The active diameter of the fiber and its numerical aperture, available on its data sheet, defines the emission angle the laser pellet should make with the fiber. The amount of laser output incident on the fiber bundle is found using the laser's relative radiant flux versus the fiber collection angle. A typical plot is shown in Fig. 1. Finally, from the bundle's packing fraction (the ratio of the useable core area to the over-all area of the bundle), the amount of power coupled into the fiber can be derived.

Usually the measured value of a laser's emitted power is slightly lower than indicated in the available specifications. However, data sheet numbers do provide a starting point.

### One example

For example, from published data on the RCA C30130 double-heterojunction laser diode it can be determined that a fiber-bundle cable with an active area of 0.015 inch can be positioned approximately 0.120 in. from the laser chip. This defines an acceptance angle of about 4° with the emitting surface of the laser pellet. From a plot of radiant flux as a function of collection angle, it is determined that about 4% of the emitted flux from the diode is incident on the active diameter of the bundle. Using a value of 40% to represent the area occupied by individual fibers in the bundle indicates that a total of only 1.6% of the laser output is coupled into the fibers.

More efficient coupling is possible using a laser with the glass window removed, so that the fiber can be placed closer to the laser pellet. Measurements taken with such a nonhermetic diode and the same fiber bundle show coupling efficiencies of 35%—which is a really

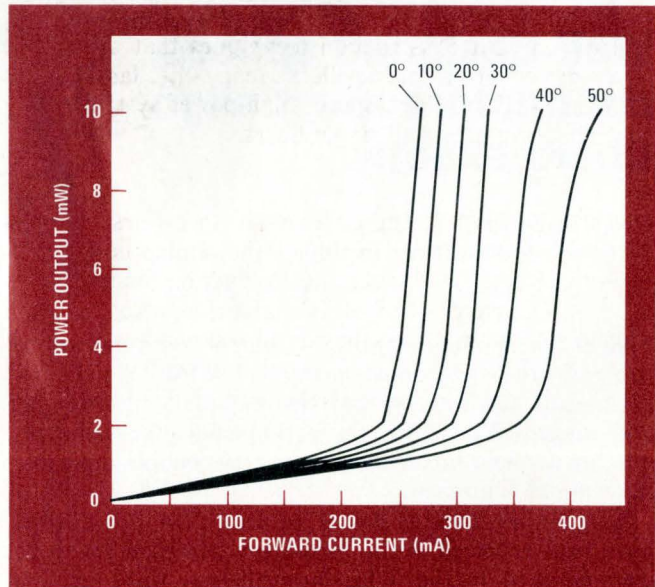

**3. Temperature-sensitive.** The threshold current for the RCA laser types C30127 and C30130 increases rapidly above room temperature. At 60°C the peak output drops to half its room-temperature value, and in some instances lasing may stop.

dramatic improvement.

One problem with laser diodes is that relatively small changes in temperature can change their output significantly. As shown in Fig. 3, threshold current for RCA types C30127 and C30130 increases at temperatures above 27°C and doubles at about 70°C, while with constant current drive applied, the peak radiant flux at 60° drops to 50% of its room-temperature value. In fact, threshold current of the drive may increase sufficiently to prevent lasing.

Because of this heavy dependence of threshold current on temperature, the laser should be operated at some fixed temperature within its operating range temperature. A small thermoelectric heat pump will maintain the laser heat-sink temperature to within a few tenths of a degree over the expected ambient temperature range.

For analog systems, it is necessary to bias the device well above the threshold point and then superimpose the analog modulating signal on the dc drive current. Figure 4 shows a typical circuit used to measure the linearity and harmonic content of a laser diode when operated in the analog mode at 10 MHz. Approximately 350 mA of bias current is sufficient to provide a continuous output of 7 mW. A 30-mA peak-to-peak 10-MHz sine wave is coupled through capacitor  $C_4$  and the laser output measured with a silicon photodiode. The first harmonic at 20 MHz is 40 dB below the fundamental with an ac drive current.

Laser lifetime remains another problem. It must be

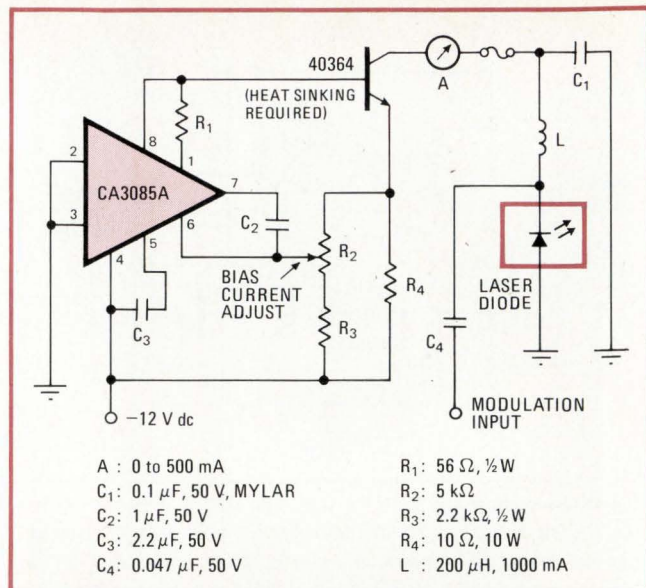

**4. Measuring linearity.** A 30-milliampere peak-to-peak 10-megahertz sine wave was coupled through capacitor  $C_4$  to modulate the laser diode. The light output was measured, and the first harmonic was 40 dB below the fundamental.

increased to well beyond 10<sup>5</sup> hours if the diodes are to find use in systems where 20-year reliability is essential. Actual laser-lifetime data isn't yet available, but data extrapolated from selected samples translates into a mean time between failures of 10 hours for some lasers with a heat-sink temperature of 22°C.

The third big problem area—efficient coupling of laser to fiber—should be alleviated with construction techniques that attach a short length of fiber directly to the laser pellet.

## CONNECTIONS

### Well-designed splices, connectors must align fibers exactly

by J. F. Dagleish  
Bell Northern Research, Ottawa, Canada

Splices for joining lengths of optical-communications cable in the field must provide low-loss, quick but permanent connections, and also be small, lightweight, and rugged. Except for the permanency, the same requirements hold for the connectors that couple the cable to terminal equipment.

Single-fiber splicing losses of less than 0.1 decibel have been reported in the laboratory but have yet to be demonstrated in the field. Nevertheless, total splicing loss in a given length of fiber both can and should be much less than the fiber attenuation.

The most critical parameter, variously called axial or lateral alignment, is also one of the most difficult to

control. Slight offset between the two fiber ends dramatically increases optical loss (Fig. 1). Alignment accuracy in the order of micrometers is needed, thus requiring similar machining tolerances of the associated hardware.

One splicing technique in widespread use is the preci-

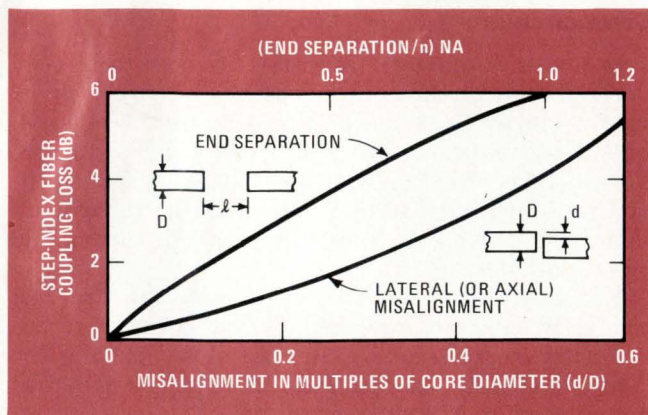

**1. Fiber offset causes loss.** Any slight offset between two fiber ends increases optical coupling loss. An axial displacement equal to half the fiber core diameter causes greater than a 4-dB loss; separating the fiber by that amount produces a 6-dB loss.

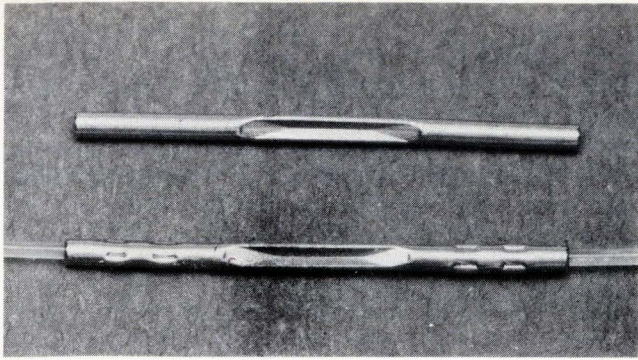

**2. Fiber guide.** A precision sleeve or tube that conforms exactly to the outer fiber diameter positions both fibers. Once both fiber ends are butted together in the splice sleeve, the sleeve ends are crimped into the fiber's plastic coating.

sion sleeve or tube, which, by conforming precisely to the outer diameter of the fiber, guides it into position and then holds it there. This requires individual handling of fibers and is most suitable for single fibers or small cables. Sleeves may be of metal or glass, and an entrance funnel aids fiber insertion. Once the fiber ends are prepared and the two fibers butted together in the splice, the outer jacket of the fiber is clamped or, in some cases, a metal sleeve is crimped around it.

A fiber splice developed by Bell Northern Research is based on this technique (Fig. 2). A stainless steel preform tube has a center alignment bore that fits the bare fiber diameter closely. The prepared fiber ends are guided into the alignment bore by tapered sections, and the ends of the splicing element are then crimped into the fibers' plastic coating for permanent assembly. Because the plastic coating extends inside the tube, no other mechanical protection is needed. With a silicone fluid pre-injected into the splicing element, insertion losses average 0.3 decibel from a LED source.

Another technique reported by Bell Telephone Laboratories—the loose tube splice—may be suitable for field use because it uses inexpensive components. It exploits the self-aligning tendency of fibers in a "V" groove (Fig. 3). Prepared fiber ends are inserted into a rectangular tube already filled with index-matching epoxy. The

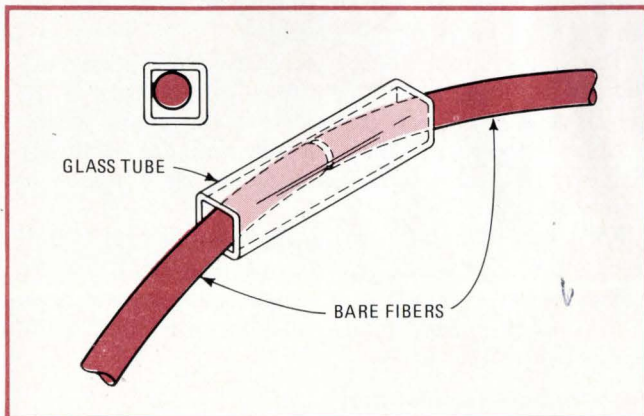

**3. Self-aligning.** The loose-tube splice, as it's called, makes use of the self-aligning tendency of the fibers. When the fibers within the tube are slightly bent, the tube rotates, holding the fiber ends in place until an epoxy positions them permanently.

fibers are slightly bent, forcing the tube to rotate so that their ends travel along a corner. Once butted together, the ends are held in place until the epoxy cures. Losses average about 0.1 db when a laser source is used.

Connectors have an added requirement: they must be able to mate repeatedly without degrading too much in coupling efficiency or mechanical integrity. They should also be simple to use, like electrical connectors.

A single-fiber connector, developed by Bell Northern Research for use with plastic-coated multimode fibers, is a variation in the precision-sleeve splicing element (Fig. 4). The connector plug has tapered funnels at each end leading into a central alignment bore (the only critical dimension). The longitudinal position of each fiber is accurately located with respect to a reference surface on each housing. This is done using a special fixture. Both the plug and its mating jack are mounted separately on a fixture, and prepared fiber ends are inserted into each connector half until they butt against the fixture's stops. Crimping the stainless-steel tubing into the fibers' plastic coating holds them firm. When mated, the reference surfaces are in contact and the fibers are separated by a small gap.

During mating, the fit between plug and jack insures that the jack fiber enters the tapered opening of the plug. Once mated, the plug and the jack are

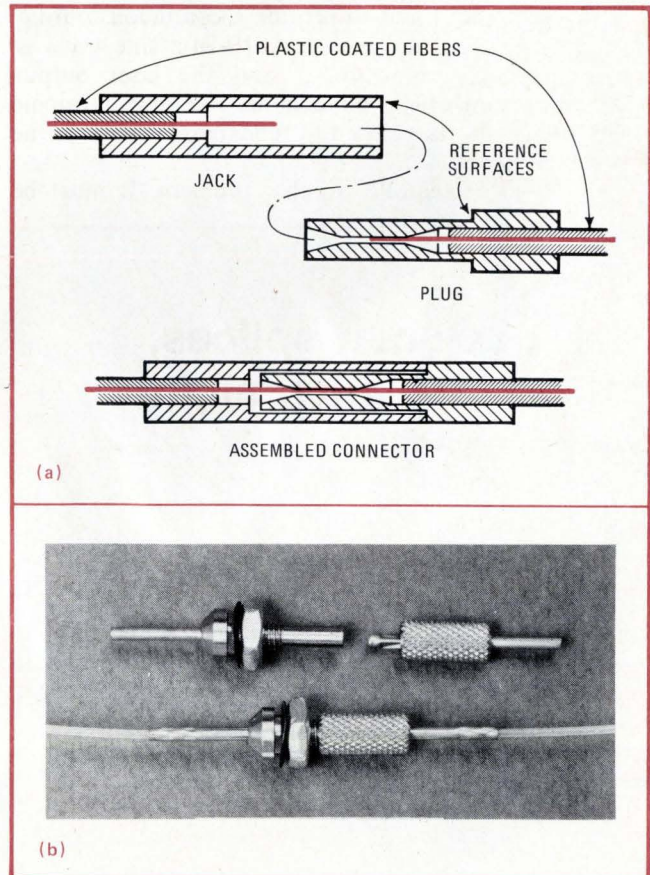

**4. Variation on a theme.** Bell Northern Research's single-fiber connector adapts the precision-sleeve splicing principle. Once mated, the connector is only 2 centimeters long and, when unmated, the plug and jack housings protect the fiber as shown.

held together with a knurled coupling nut (a bulkhead panel mount is provided on the jack). When unmated, the housing configurations of both the jack and plug sections are such as to protect the fiber ends.

## CONNECTIONS

### Metal connectors protect fibers during termination and in the field

by K. J. Fenton

*ITT Cannon Electric, Santa Ana, Calif.*

Metal connectors that terminate or couple fiber bundles differ from single-fiber metal connectors both in the way they deal with fiber alignment, handling and protection and in optical end preparation.

Some requirements, though, are identical. Both types of connector must provide for terminating the

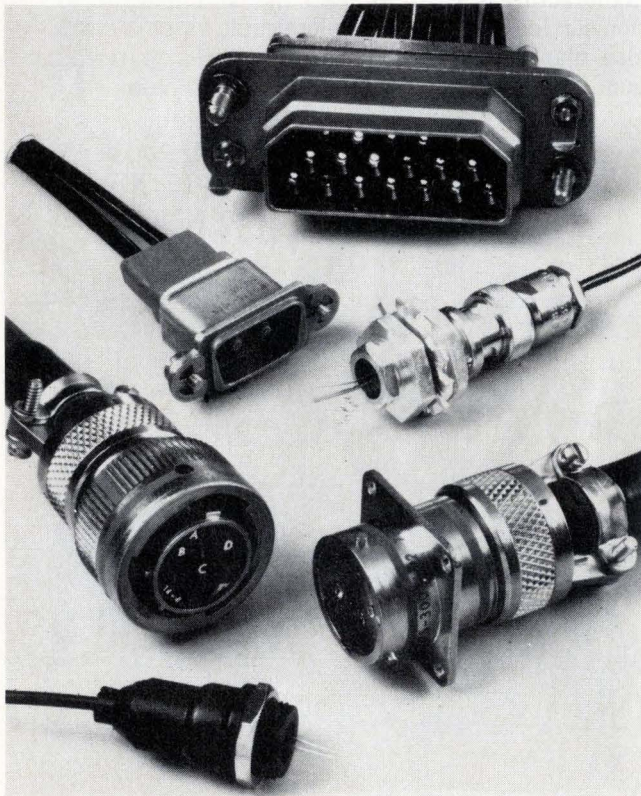

**1. Wide selection.** Connectors for fiber-bundle cables are available in both circular and rectangular shapes and can accommodate from 1 to 18 optical channels. These products can also couple either photodetectors or light sources to fibers.

Typically, rematable insertion loss of the connector is 1 dB when an index-matching fluid and a LED source are used. Smaller losses have been reported with experimental connectors, but this device is more practical, in that its standard-diameter alignment bore can accommodate manufacturing tolerances in fiber diameter. When installed in prototype fiber-optic systems, both with and without index-matching fluid, these connectors showed typical insertion loss variations of less than 0.2 dB, after being remated up to 100 times.

jackets, strength members, and buffering materials used in fiber cables, and both must insure that loads applied to the cable are not transmitted to the terminated fiber. Moreover, optical-fiber connector designs must provide for protection of the fibers during termination and end preparation as well as after they are installed in the connector.

#### Alignment critical

The alignment of a fiber bundle with a LED or laser diode source, photodetector, or other bundles is far less critical than the alignment of a single fiber for these same three connection areas. The coupling losses between pairs of fiber bundles as well as single fibers depend heavily on their degree of lateral (or axial) misalignment.

Rather less critical than lateral alignment is the size of the gap between prepared fiber ends (though there must be a gap), and less critical still, though still important, the angular alignment of their center lines.

In separable connectors it is extremely important that the prepared ends of the fibers do not touch since otherwise repeated matings of vibration and shock will chip and scratch the optical-fiber surface and degrade the optical efficiency of the connector. But the gap cannot be too large—if the coupling losses contributed by it are to stay within 0.2 decibel, it should not exceed 10% of the active core diameter of the fiber bundle or single fiber. This works out as a 75-micrometer (0.003-inch) gap for a typical 1,125- $\mu\text{m}$  (0.045-in.) bundle or a 5- $\mu\text{m}$  (0.0002-in.) gap for a 50- $\mu\text{m}$  (0.002-in.) core for single fiber.

The loss characteristics for these gaps also vary slightly as a function of the numerical aperture of the bundle or single fiber. Angular misalignment within  $\pm 1^\circ$  for bundles of optical fibers and half that for single optical fibers results in acceptable losses of from 0.1 dB to 0.2 dB.

For both bundle and single-fiber connectors, a chip-free, scratch-free, flat surface, perpendicular to the fiber centerline, is essential for good optical coupling. If any of these conditions is lacking, light scattering occurs at the fiber ends.

#### Fiber-bundle termination

A rather simple polishing procedure can produce a sufficiently good optical interface on a fiber bundle. When being polished, all of the fibers must be held rigid and adequately supported to prevent them from

chipping or cracking.

Usually, the fiber bundle is first stripped of its jacket and fiber buffering materials, and the exposed fibers are cleansed of lubricants and contaminants. For most cables, epoxy is applied to the fibers to immobilize them, and the bundle is slipped into a termination device that packs it into a tight hexagon. The hex shape provides the optimum packing fraction (the ratio of the cross-sectional area of the fiber cores to the total area of the fiber bundle). At this point, the epoxy has cured, and any excess fiber length is cut off with wire cutters or scissors.

A two-step, wet-polishing procedure comes next. First a 400 grit abrasive is used to rough-polish the ends, and then a 0.03-micrometer paste applied with a felt wheel produces the final finish. The two steps take less than 1 minute. Additional polishing does not improve matters and often reduces optical efficiency because it may dome the fiber ends. The final step is to protect the prepared end with a thin, transparent cap supplied with the connector.

### Single-fiber termination

The end preparation and termination for a single fiber is significantly different. The jacketing and fiber buffering materials are removed, as before, but the exposed fiber is then broken in a fixture to the precise length required. (Fixtures capable of producing the necessary controlled, consistent break have been developed by several manufacturers.) Also, the fiber end must be precisely located within the terminating device, and this critical step must be accomplished by other special fixtures.

Several manufacturers offer a variety of optical

connectors for the termination of fiber bundles. Circular or rectangular in shape, these accommodate from 1 to 18 optical channels or combinations of electrical and optical channels. Several connectors in various sizes and mounting styles available from ITT Cannon (Fig. 1) couple standard LED or laser-diode sources to fibers, fibers to fibers, and fibers to photodetectors.

Coupling losses depend on the size and number of fibers in the bundle, the core-to-cladding ratio of each fiber, and the numerical aperture of the fiber bundle. Losses from fiber bundle to fiber fall between 2.5 decibels and 3.5 dB.

### Making a match

Source-to-fiber and fiber-to-detector coupling efficiency, however, varies not only with the connector but with the device characteristics and how well the fiber is matched to either detector or source. For example, an edge-emitting laser produces a doughnut of light in the near field; if the fiber is placed in the middle, then no light is coupled into it. As for the connector's effect, using different types to couple commercially available light-emitting diodes and photodetectors to fiber-bundle cables results in a wide range of coupling losses—source-to-fiber bundle coupling loss can vary from 3 dB to 14 dB with off-the-shelf devices while fiber-bundle-to-photodetector coupling loss can vary from 0.5 dB to 8.5 dB.

In addition to selling just optical connectors, some manufacturers offer an economical bundle-termination service as well as complete cable assemblies. Most also plan to offer tooling and fixtures to terminate bundles in the factory as well as in the field.

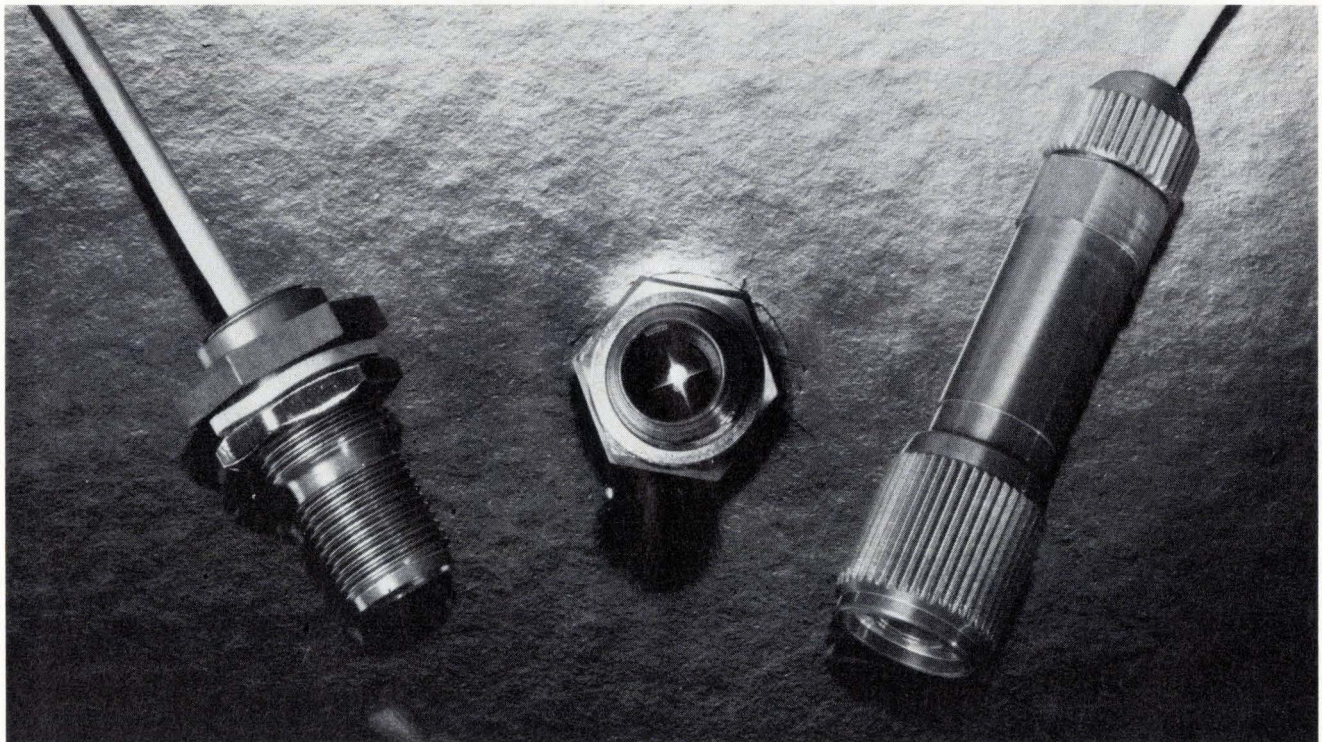

**2. New entry.** Few companies as yet are marketing single-fiber-per-channel connectors, but this recently released connector from ITT Cannon Electric can be used to join two single fibers or to couple a photo or a LED or laser diode to the fiber.

Connectors for some single-fiber cables are presently offered on a limited quantity, special-order basis. In fact, the only types available at present are for cables containing either one or six functionally

different fibers. The single-fiber-per-channel connector shown in Fig. 2 is a very recent introduction.

The coupling efficiencies of these single-fiber connectors vary with fiber type, overall fiber size, core size, and the numerical aperture of the fiber. Fiber-to-fiber optical losses also vary, depending on the quality of the fiber-end preparation and accuracy of termination location within the termination device. Typically, coupling losses of from 1 dB to 2.5 dB are expected in these connectors.

## CONNECTIONS

### Low-cost plastic connector speeds the polishing of fiber-bundle ends

by T. Bowen  
AMP Inc., Harrisburg, Pa.

Molded thermoplastic connectors are an inexpensive, fast, and reliable way of terminating fiber-optic bundles. Economically mass-produced, they weigh much less than metal parts and also interfere less with the optical polishing of the bundle ends. Any plastic smeared across the fiber surface during the polishing will be too soft to score them, unlike metal, and can easily be removed.

The connector shown in Fig. 1 is one of a series designed to further simplify the polishing process—in fact, as will be explained later, it can be installed in the

field by people without special skills or training. Equally important, it optimizes packing fraction—the ratio of active cross-sectional area of optical-fiber cores to the total end-surface area of the bundle—and can handle the full range of fiber-bundle types and size from most major fiber-cable manufacturers.

It mates with either an input/output bushing that can house many standard light sources and detectors or with a splice bushing for terminating cables. For a dry splice—two face-to-face terminations separated only by air—insertion loss is about 3 decibels, a figure that falls to about 2 dB when an index-of-refraction-matching fluid is added as a coupling medium.

Before this connector can be attached to an optical-fiber cable, the cable's jacket must be stripped away and a generous amount of an epoxy or a cyanoacrylate adhesive applied to the exposed fibers. The connector assembly then slides easily onto the bundle, and the crimp ring attaches it to the jacket. The closing action of the specially contoured polishing bushing radially compresses the nose end of the ferrule, squeezing all the fibers together. This spreads the adhesive thinly,

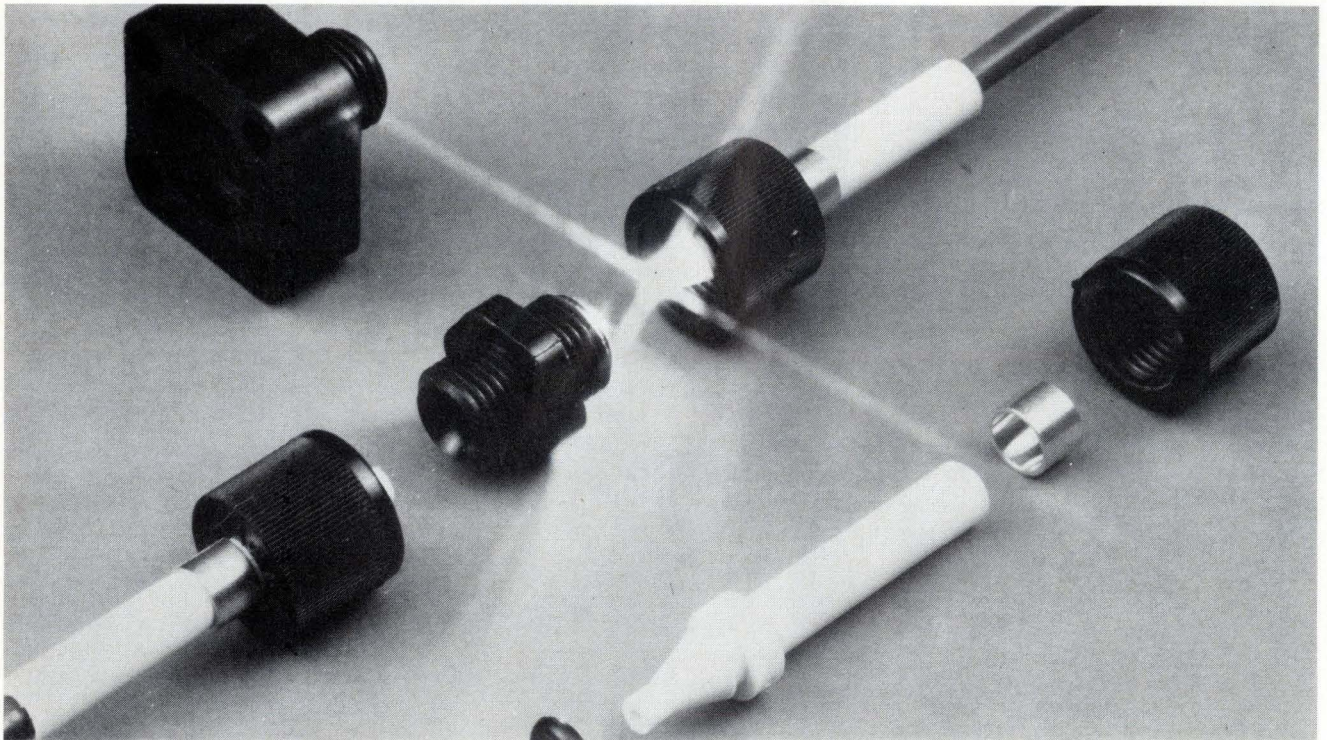

**1. Plastic housing.** This connector assembly can handle fiber bundles with diameters from 0.02 to 0.075 inch. The termination mates with a splice bushing for fibers (middle) or a bushing (top) that houses several standard light sources or detectors.

allowing it to set up instantly and lock the fibers.

Next, with the special bushing still attached, the bundle is polished by being wiped across three separate grades of sandpaper with abrasiveness ranging from 320 grit to 600 grit. Then the fibers are simply wiped clean and the polishing bushing discarded. Extra polishing gains only a couple of tenths of a decibel.

In terminating plastic optic fibers, as in the DuPont PFX bundle, the process is even simpler. There is no need to remove the jacket or immobilize the fibers with adhesive or epoxy—the jacket material extruded around the soft plastic fibers holds them tight enough. In fact, because the connector assembly is attached to the jacket with a crimp ring, the use of adhesive can be eliminated from the end-termination procedure entirely. The remaining procedure is then the same as for the more brittle glass-fiber bundles.

Mating bushings provide the necessary alignment

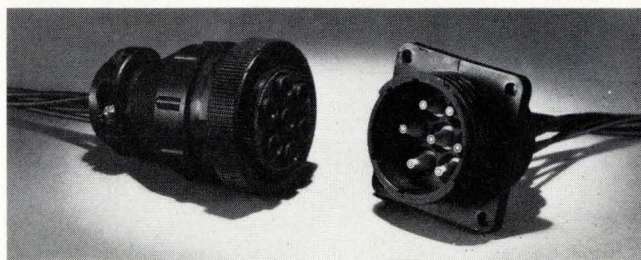

**2. More than one.** Without any modifications, several end terminations can be used to form multiposition connectors. With two fibers face to face in a splice bushing, insertion loss is about 3 decibels. This drops to 2 dB with an index-matching fluid.

mechanism for source-to-bundle and bundle-to-detector coupling. To protect the optical interfaces from contaminants, an O-ring seated on the ferrule engages the face of the bushing when the parts are mated.

## DETECTORS

### Inexpensive p-i-n photodiodes match fiber, source characteristics

by P. H. Wendland, R. M. Madden, and B. Kelly  
United Detector Technology Inc., Santa Monica, Calif.

The receiver portion of any fiber-optic system requires a photodetector that responds strongly to both the peak output wavelength of the source and the low-loss spectral portion of the fiber cable used. Just as important is the match between the detector and its amplifier. On the whole, these needs in most emerging systems seem better served by p-i-n diodes than by either phototransistors or avalanche diodes.

Silicon phototransistors are inexpensive—typically less than \$1 each in large quantities. But their slow speed limits system bandwidth to less than a few megahertz, their poor linearity restricts their dynamic light-level range to about three decades and, worst of all, internal noise is an order of magnitude greater than in p-i-n photodetectors.

#### Getting gain

Avalanche photodiodes combine optical signal detection with internal amplification of photocurrent. But unfortunately, they also amplify noise—the avalanche mode creates it, and it reduces the internal signal-to-noise ratio.

However, the devices have their uses at the higher frequencies, because above 1 MHz system noise limitations are set by the preamplifier and not the detector. Also, though future devices may operate at voltages below 100 volts, today's units now need 200 to 300 v, so that a high-voltage power supply is required, and often a constant-temperature chamber as well.

All the same, avalanche photodiodes could prove

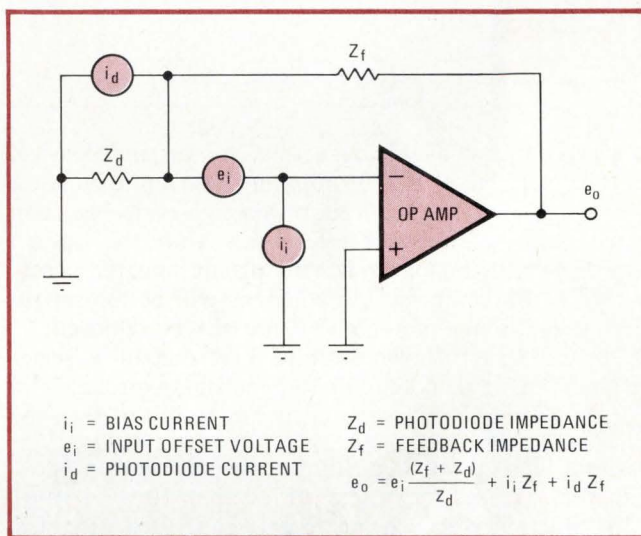

**1. Team effort.** Output current from a reverse-biased photodiode depends on its responsivity and the amount of light striking it. The output voltage of the combination is simply the product of the photodiode current and the feedback resistance.

useful in pulse-code-modulated systems, where the absolute level of the analog signal is not of major importance and the highly regulated power supply and a constant temperature chamber might therefore prove unnecessary. In amplitude-modulated communications systems, however, the effect of environmental and particularly temperature changes on avalanche diode gain would cause considerable problems.

High-performance p-i-n type silicon photodiodes have been in production for many years and cost less than \$1 each. They exhibit nanosecond response times and can have a dynamic light-level range of 8 to 10 orders of magnitude at relatively low bias voltages. Their peak response between 850 and 950 nanometers matches well with the peak emissions of light-emitting diodes and the low-loss spectral regions of optical fibers.

These photodiodes are usually connected to a relatively low impedance to allow the photo-excited carriers to induce a photocurrent in the load circuit. (Photovol-

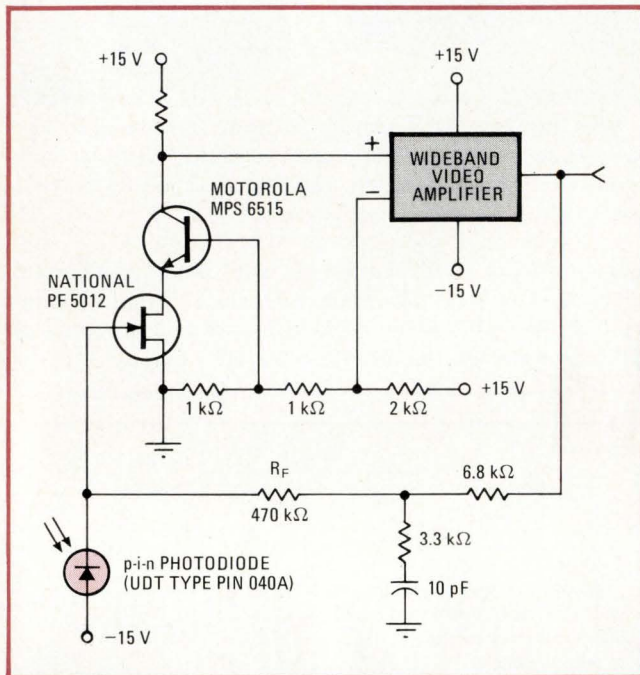

**2. Typical circuit.** The input field-effect transistor sets the overall noise performance of the photodetector-amplifier combination. Operating with 10-MHz optical-fiber links the circuit provides a signal-to-noise ratio of 5:1 for input power levels of 10 nW.

taic mode operation with open-circuited terminals is possible, but gives logarithmic outputs and a slow response.) Geared for systems of less than 10 MHz, 30-ns p-i-n photodiodes are commonly operated at bias voltages of about 15 V to reduce carrier drift time and lower diode capacitance without introducing an excessive dark current.

Operating a reverse biased p-i-n photodiode into a

low-impedance operational amplifier (Fig. 1) provides maximum linear dynamic range and fastest response. The basic limitations of this circuit lie with the amplifier, not the detector. Present operational amplifier technology restricts the bandwidth to about 5 megahertz at input noise currents corresponding to light levels below 10 nanowatts.

A reverse-biased detector creates noise, however. There is the shot noise caused by detector dark current and signal current, the Johnson noise of the feedback resistor, and the input noise voltage of the amplifier. In wideband applications, the noise voltage of the amplifier,  $e_n$ , usually dominates. Its input noise voltage appears at the output, magnified by the ratio of the feedback resistance divided by the source impedance. At the higher frequencies, the capacitive reactance term of the source impedance predominates.

### Critical components

Consequently, it's essential to minimize not only the input noise voltage of the preamplifier, but the input capacitance and noise bandwidth as well. Input capacitance has three components: amplifier input capacitance, detector capacitance and stray capacitance. The noise bandwidth is usually much larger than the signal bandwidth, and therefore it is essential that the amplifier bandwidth be made no greater than overall system constraints dictate.

Ideally, the preamplifier should raise the detector signal level to a magnitude that is easily manipulated by conventional analog or digital electronics without adding excessive noise or degrading the performance of the detector. The circuit shown in Fig. 2 typifies detector/preamplifier combinations available for use in fiber-optic systems.

The very low input impedance (10 to 50 ohms) of the transimpedance amplifier configuration is an ideal load line for the silicon p-i-n detector, assuring its linear operation and improving its frequency response. The amplifier, which acts as a current-to-voltage transducer, provides an output voltage equal to the photodiode current multiplied by the feedback resistance.

## COUPLING

### In systems with 20 or more terminals, star couplers outperform 'tee' types

by M. K. Barnoski  
Hughes Research Laboratories, Malibu, Calif.

In a multiterminal fiber-optic communications network, light signals have to be tapped at intermediate points along the data bus. The problem is how to tap them most efficiently.

Currently, two fiber-coupling configurations are used for such data-distribution systems, one employing access

or "tee" couplers and the other using a radial-arm or star coupler. The equations in Fig. 1 enable their performance to be compared in terms of the loss introduced between pairs of remote terminals by the distribution system itself. These equations show that, in a serial system with access couplers having a constant tap ratio, the optical power decreases as the signal travels through more couplers, while in a parallel system using a star coupler, the optical power is independent of the pair of system terminals being considered.

The distribution-system losses (omitting fiber loss) for both serial and parallel configurations are plotted as a function of the number of terminals in Fig. 2. Several different sets of parameters were employed for each format, including the use of multimode-fiber bundles as well as single multimode fibers. As a limiting case, curves are included for both parallel and serial systems when all couplers and connectors are assumed lossless. In



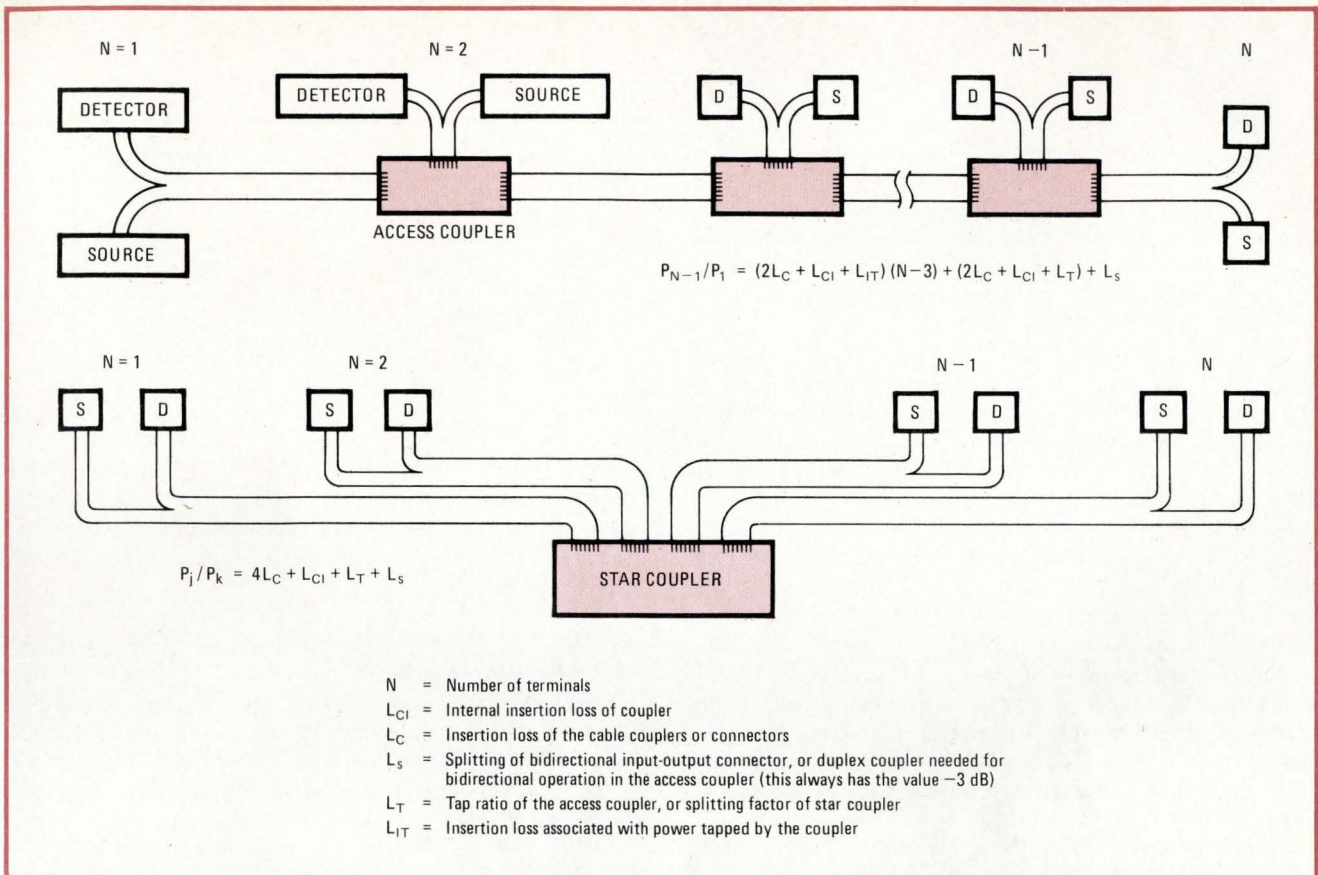

**1. Coupling comparisons.** The difference in performance between a serial distribution system and a parallel system is partly due to the terminal-to-terminal loss introduced between pairs of remotely spaced terminals by the distribution network itself.

this idealized case, the distribution-system losses result only from dividing power among the various terminals.

The comparison clearly shows that, as the number of terminals in a system increases, the distribution losses of the serial format grows rapidly while those of the parallel format increase only gradually. This signal-level advantage further increases as higher-insertion-loss cable connectors and the access couplers are used, but is relatively insensitive to insertion loss of the star coupler. In a serial system based on fiber bundles, the minimum access-coupler and connector-insertion loss will be limited by the packing-fraction loss of the bundled fibers. As a result, the steep curve plotted in Fig. 2, which uses an access-coupler loss of 2 dB and connector-insertion loss of 1 dB, is very close to what can be expected from fiber bundles having good packing fractions.

Nevertheless, with low-loss connectors and couplers for single fibers, serial-distribution systems should be able to handle at least 20 remote terminals without consuming an unreasonable proportion of the available power budget. For fewer than 20 terminals, the power savings achieved by the star system are not so very large.

However, as more terminals are added and use more of the available optical power budget, the picture changes. Receivers in a serial system must have not only a large dynamic automatic-gain-control range, to handle both strong signals from adjacent terminals and weak

signals from remote terminals, but also low enough noise levels not to degrade the weak signals.

Since the parallel system needs only a single mixing point, it doesn't suffer signal-level or dynamic-range problems. The more constant signal level available with parallel systems minimizes the complexity of both trans-

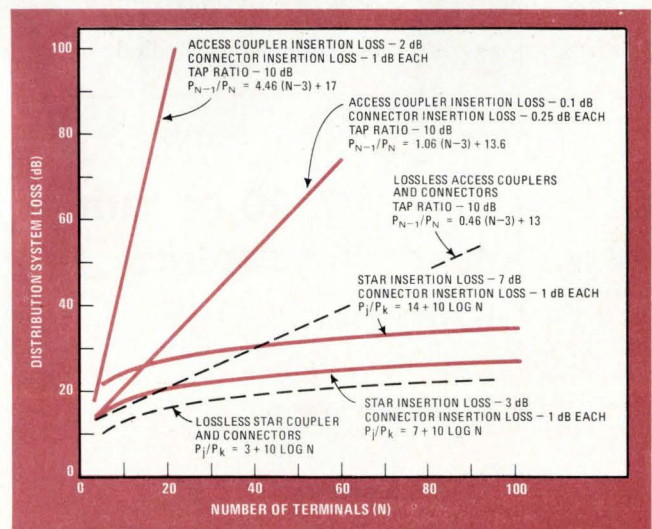

**2. System losses vary.** Several sets of parameters were used to plot the distribution-system losses as a function of the number of terminals. In the idealized case, distribution losses result only from the splitting power among various terminals.

mitter and receiver design. But the cost of this uniformity is offset by the additional amount of fiber cable needed. The star-coupled data bus, in essence, shortens the main bus length to a single-point mixer, but extends the length of each terminal arm.

A star coupler or optical mixer was basic to a prototype, fiber-optic multiterminal aircraft data link for carrying flight control signals from cockpit to controls. The optical bus operated for the full duration of a 40-minute flight test aboard an Air Force C-131 aircraft without any detectable errors.

The system used three terminals (one for redundancy) to multiplex and demultiplex 16 analog electrical signals (Fig. 3). It was "wired" with Corning fiber bundles, each containing 61 multimode low-loss glass fibers loosely packaged in an extruded polyvinyl chloride jacket. Two of these bundles entered each terminal, one for the transmitter and one for the receiver. Maximum terminal-to-terminal spacing was about 100 feet, but since each terminal in the system monitored its own transmission, the longest path traversed by an optical signal was 200 ft.

Commercially available components were used: gallium-arsenide light-emitting diodes as sources, silicon p-i-n devices as photodetector/amplifiers, and modified BNC connectors for input and output coupling. Nominal optical output power incident on the receiver photodiodes was -28 dBm. Source power was about +11 dBm. Although the optical bus was designed for a 10-megahertz bandwidth, the actual information transfer rate was determined by other system considerations and

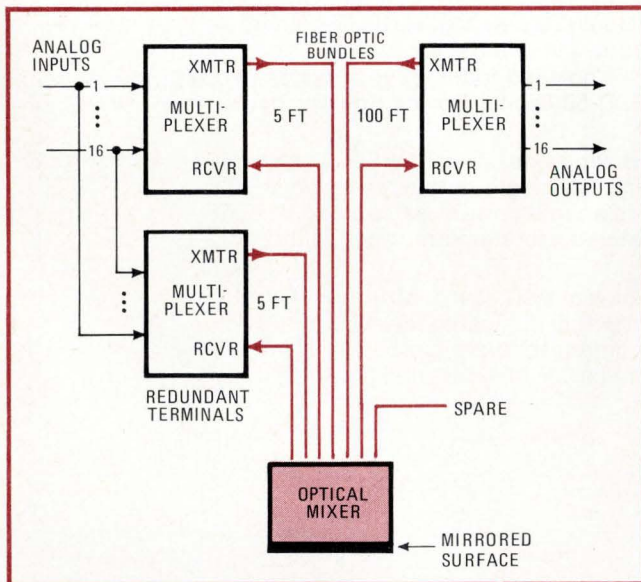

**3. Flight-tested.** A three-terminal redundant system for carrying flight control signals aboard a C-131 aircraft used a star coupler and seven fiber bundles to multiplex and demultiplex the 16 analog electrical fly-by-wire signals.

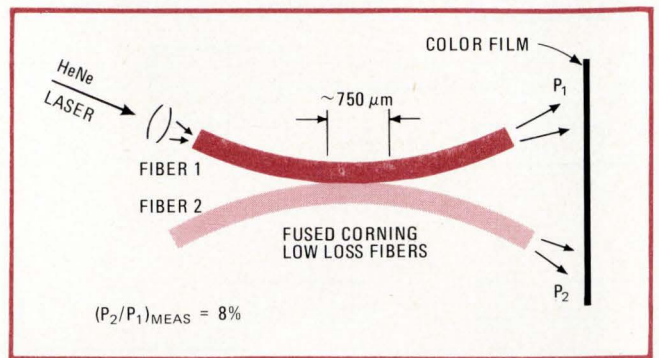

**4. Mixing modes.** One method of coupling light between single fibers is to bring the cores of the optical fibers so close together for a selected interaction length that the light modes of one fiber mix with those of the other fiber.

was only 0.5 megabit per second for all three transmission systems evaluated.

Although fiber bundles were used in this feasibility demonstration, a single-fiber configuration could service a network of 427 terminals (61 fibers times 7 bundles). For such a network, the distribution loss extrapolated from Fig. 2 would be 40 dB, assuming 1-dB cable connector loss and 7-dB star-coupler insertion loss.

However, in systems using a single fiber as a communication channel, it should also be possible to use serial distribution of data, since packing fraction loss is no longer a factor. Of course, adequate techniques of coupling between single fibers would first have to be developed.

One possible approach to fabricating such an access coupler (Fig. 4) parallels the techniques used in integrated optics. In essence, two multimode fibers are laid side by side and fused together for part of their length, and this fused region subverts (as it were) the tendency of each to keep all its light to itself. For in this situation, since light propagates in these fibers in many modes, the modes in one fiber mix with those in the other, producing coupling between mode groups. The exact degree of coupling is determined by the core-to-core spacing and the interaction length (the fused region). When one end of one fiber was excited with a laser beam, radiation was observed from the opposite ends of both fibers. For the coupler used in this experiment the ratio of power emitted from the access channel fiber to that of the main channel was 8%.

It's worth noting how neatly this approach avoids the need for the critical mechanical alignment tolerances that are essential in access couplers using conventional optical components like lenses and beam splitters. In fact, several research laboratories are currently investigating fabrication processes for such a "tee" fiber coupler. The preliminary results indicate that the insertion loss of single-strand access couplers could come down to about 0.1 dB or 0.2 dB, so all that remains is to produce practical low-cost versions of these experimental devices. □

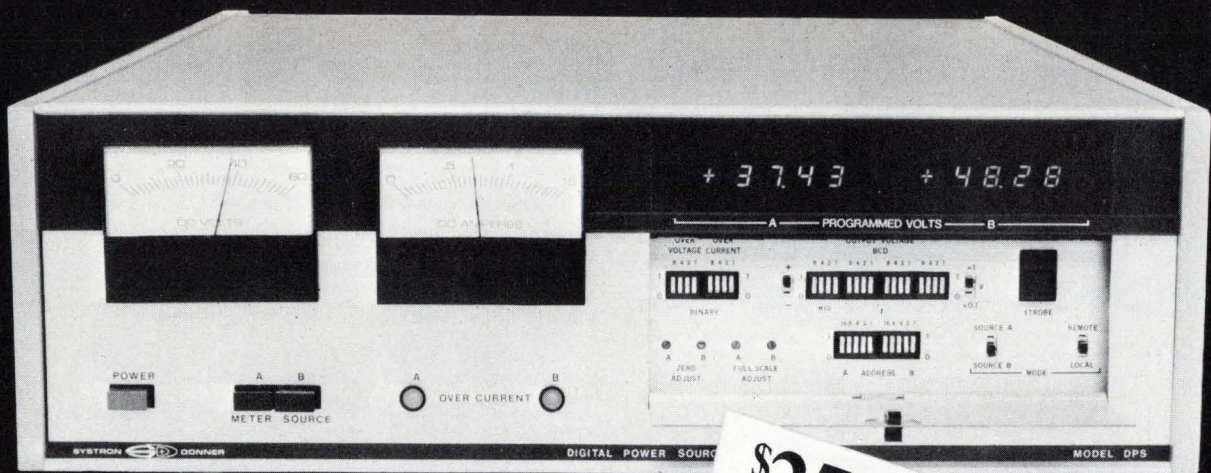

# WHAT?

## That much for one systems power supply?

No. That much for two.

Look closely and you'll see that Systron-Donner's new Model DPSD-50 has *two* independent floating precision power sources in *one* 5¼-inch rack. Each provides 0 to  $\pm 50$  volts at 1 amp. Now, there's no need to fill up your system with one-output power supplies. Use the DPSD-50 Digital Power Source instead, and cut your space requirements in half!

It's not only space you'll save, either. Buying one Model DPSD-50 with two power sources at \$3,500 sure beats buying *two* single-output models at \$2,000 or more *each*. The price of other supplies spirals upward as you add options. Not so with the DPSD-50. *All* of its features are standard, except the IEEE 488-1975 interface option.

And look at these features! Everything you want, standard: programmable voltage and polarity, both channels; overcurrent limit, overvoltage limit, addressable memory, optical isolation, manual control, self-verification, visual display of input data. Key specifications: resolution, 1 mV; basic accuracy, 1 mV; stability, 300 microvolts.

So, if you need more than one supply as a programmable voltage source, why not start with the one supply that's two? Contact Scientific Devices, or S-D at 10 Systron Drive, Concord, California 94518. Phone (415) 676-5000. Overseas, contact Systron-Donner in Munich; Leamington Spa, U. K.; Paris (Le Port Marly); Melbourne.

SYSTRON  DONNER

## Multimeter measurements yield device-model parameters

by Martin A. Green  
University of New South Wales, Kensington, Australia

In computer analysis of electronic circuits, the most frequently used bipolar-transistor models for dc conditions are derived from the well-known Ebers-Moll equations:

$$\begin{aligned} I_E &= -I_{ES}[\exp(qV_{BE}/kT) - 1] \\ &\quad + \alpha_R I_{CS}[\exp(qV_{BC}/kT) - 1] \\ I_C &= \alpha_F I_{ES}[\exp(qV_{BE}/kT) - 1] \\ &\quad - I_{CS}[\exp(qV_{BC}/kT) - 1] \\ I_B &= -(I_E + I_C) \end{aligned}$$

where  $I_E$ ,  $I_C$ , and  $I_B$  are the terminal currents,  $V_{BE}$  and  $V_{BC}$  are the voltages between these terminals,  $q$  is the electron charge,  $k$  is Boltzmann's constant, and  $T$  is the absolute temperature. A positive value of current flows into the transistor; a negative value flows out of the transistor. Values of the Ebers-Moll parameters  $I_{ES}$ ,  $I_{CS}$ ,  $\alpha_F$ , and  $\alpha_R$  are usually required as program inputs [see "Modeling the bipolar transistor, part 1," *Electronics*, Sept. 19, 1974, p. 114]. These parameters, as well as the device beta, can be determined for any given transistor

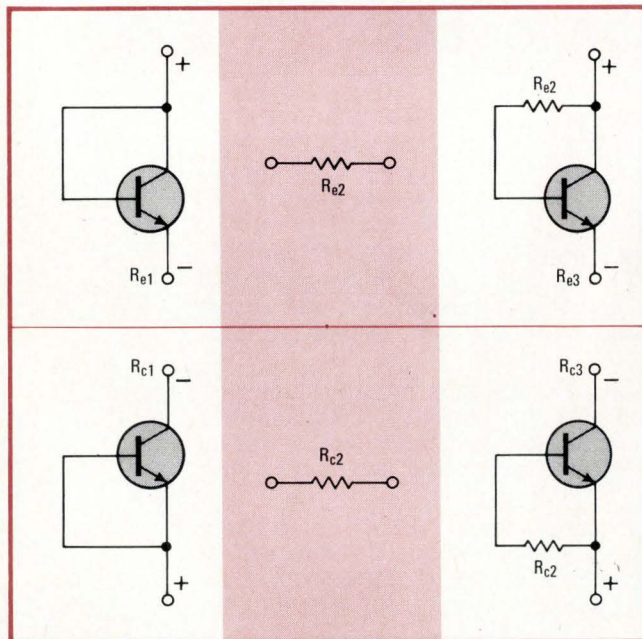

**Just measure ohms.** These six resistance measurements, made with a digital multimeter, yield the parameters for the Ebers-Moll model of a transistor. The open circles represent the terminals between which the measurements are made, while the + and - signs indicate the bias the DMM must establish on the junctions.

by measuring six resistances with a digital multimeter. The method exploits the measurement technique commonly used on the resistance ranges of a DMM, which is, essentially, to pass a known constant current through the unknown resistance and measure the resulting voltage developed across it. The current passed,  $I_M$ , depends on the resistance range selected and, typically, may vary from 100 nanoamperes on high-resistance ranges to 10 milliamperes on low ranges.

Preliminaries consist of determining the current through the unknown on the different ranges of the DMM and selecting the range where the current,  $I_M$ , is reasonably near the probable operating current of the transistor.  $I_M$ , multiplied by the full-range reading in ohms must equal a voltage large enough to forward-bias the transistor junctions (about 0.7 V for silicon devices).

All measurements described (except those of  $R_{e2}$  and  $R_{e3}$ ) must then be made on this range. After experimenting to find which direction of the probe connections forward-biases the transistor junctions, the following measurements are performed (see the diagram):

- Measure  $R_{e1}$ , the forward-biased resistance of the emitter-to-base junction with collector shorted to base.
- Select a resistor with its nominal resistance near the value  $\beta_F R_{e1}$ , where  $\beta_F$  is the estimated beta of the transistor in the normal forward mode of operation. Measure the exact resistance,  $R_{e2}$ , of this resistor.
- Measure the resistance between the emitter and collector while the emitter-to-base junction is forward-biased and  $R_{e2}$  is connected between the base and the collector. Call this value  $R_{e3}$ .
- Repeat the above procedure with the transistor in its inverse connection, i.e., with the collector and emitter exchanged in the above description. Record the corresponding resistances  $R_{e1}$ ,  $R_{e2}$ , and  $R_{e3}$ .

From the Ebers-Moll equations, it is not difficult to show that the required transistor parameters can be calculated by the expressions:

$$\begin{aligned} \alpha_F &= 1 - (R_{e3} - R_{e1})/R_{e2} \\ \beta_F &= [R_{e2}/(R_{e3} - R_{e1})] - 1 \\ I_{ES} &= I_M/\exp(R_{e1}/r_e) \\ \alpha_R &= 1 - (R_{e3} - R_{e1})/R_{e2} \\ \beta_R &= [R_{e2}/(R_{e3} - R_{e1})] - 1 \\ I_{CS} &= \alpha_F I_{ES}/\alpha_R \\ &\quad [\text{or } I_M/\exp(R_{e1}/r_e)] \end{aligned}$$

where  $r_e$  is equal to  $(kT/q)/I_M$  and has a value in ohms of  $25/I_M$  at temperatures around 17°C if  $I_M$  is expressed in milliamperes.

As an example, the following measurements were made upon a 2N3693 transistor using the 20-kΩ range of a Fluke 8000A DMM (except for the measurement of  $R_{e2}$ ). The current through the unknown in this range was 0.1 mA, giving a value of  $r_e$  of about 250 Ω. The measured resistances were:

$$R_{e1} = 6,080 \Omega$$

- $R_{e2} = 216,000 \Omega$
- $R_{e3} = 10,630 \Omega$
- $R_{c1} = 5,620 \Omega$
- $R_{c2} = 4,770 \Omega$
- $R_{c3} = 9,760 \Omega$

These readings yield the following values for the transistor parameters:

- $\alpha_F = 0.979$
- $\beta_F = 46.5$
- $I_{ES} = 3 \times 10^{-15} \text{ A}$
- $\alpha_R = 0.132$
- $\beta_R = 0.152$
- $I_{CS} = 2 \times 10^{-14} \text{ A}$

Inserted into the Ebers-Moll equations, these values allow the transistor performance to be predicted over a wide range of operating conditions.

At moderate to high current levels, parasitic resistances can influence the transistor performance [see "Modeling the bipolar transistor; part 2," *Electronics*, Oct. 31, 1974, p. 71]. This method of calculating  $\alpha_F$ ,  $\alpha_R$ ,  $\beta_F$ , and  $\beta_R$  continues to give accurate results. The value calculated for  $I_{ES}$  also will usually be accurate for values of meter current,  $I_M$ , up to the likely maximum of 10 mA. However, the first expression given for  $I_{CS}$  is preferable to the alternative one that is given in brackets, because the high series resistances associated with the base and collector can cause the bracketed expression to be inaccurate. □

## Spectrum analyzer aids fm deviation measurement

by Glenn Darilek  
Southwest Research Institute, San Antonio, Texas

The ordinary technique for measuring the frequency deviation of a frequency-modulation signal is the carrier-null method. The level of the modulating voltage is increased, or the modulation frequency  $f_{mod}$  is decreased, until the carrier level goes to zero—disappears from the screen of the spectrum analyzer. At that point, the modulation index,  $\beta$ , equals 2.405, so the frequency deviation  $\Delta f$  equals  $2.405 \times f_{mod}$ .

But sometimes it may be necessary to determine the frequency deviation of an fm signal when the amount of deviation is not sufficient to use the carrier-null method. Also it may not be possible to vary the frequency or amplitude of the modulating signal in order to get a carrier null. In either of these situations, the modulation index, the frequency of modulation, and hence the frequency deviation can be easily determined by the technique described here.

The frequency deviation of a narrow-band fm signal can be determined quickly by observing the voltage ratio between the first sideband and the carrier, together with their frequency separation. These measurements can be made directly from a spectrum-analyzer display.

The amplitude-ratio measurement gives the modulation index,  $\beta$  of the signal. This index is defined as

$$\beta = (\text{frequency deviation})/(\text{modulation frequency}) \\ = (\Delta f)/f_{mod}$$

For narrow-deviation fm signals such as those in telemetry and communications links,  $\beta$  is equal to twice the ratio of the first sideband to the carrier. This relationship is accurate within 10% for  $\beta$  values below 0.8 (i.e., for the first sideband below the carrier by 8 decibels or more).

The amplitude of the carrier of any fm signal is proportional to the Bessel function  $J_0(\beta)$ , and the ampli-

tude of the first sideband is proportional to  $J_1(\beta)$ . For small values of  $\beta$ , however,  $J_0(\beta)$  is nearly equal to unity, and  $J_1(\beta)$  is nearly equal to  $\beta/2$ . Therefore,

$$(\text{first sideband})/(\text{carrier}) = J_1(\beta)/J_0(\beta) = (\beta/2)/1$$

or

$$\beta = 2(\text{first sideband})/(\text{carrier})$$

As an example, assume that the carrier of a particular fm signal is set at an arbitrary level of 1.0. If the first sideband is at a level of 0.2, the modulation index is:

$$\beta = 2 \times (0.2)/(1.0) = 0.4$$

If a decibel scale is used, one simply adds 6 dB to the ratio and converts this sum to an amplitude ratio. For example, in the illustration, the ratio of the first side-

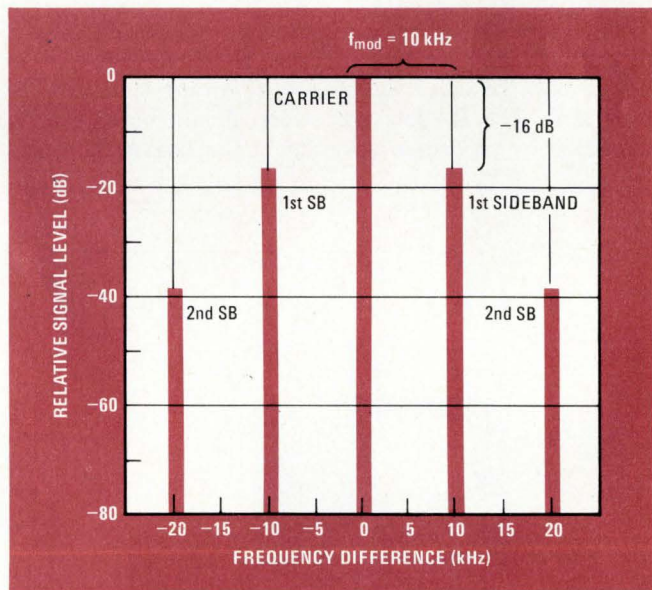

**Analyzer display.** Frequency spacing and relative amplitudes of carrier and sidebands in an fm signal can be read off directly from spectrum analyzer. The modulation frequency,  $f_{mod}$ , is given by the difference in frequency between adjacent components, and for small values of modulation index  $\beta$ , the numerical ratio of first sideband to carrier amplitude is  $\beta/2$ . Frequency deviation  $\Delta f$  of the fm signal is then found from  $\Delta f = \beta \times f_{mod}$ .

band amplitude to the carrier amplitude is measured to be  $-16$  dB, so

$$\beta \text{ (dB)} = -16 \text{ dB} + 6 \text{ dB} = -10 \text{ dB}$$

Conversion of  $-10$  dB to a ratio gives  $\beta = 0.32$ .

To find the actual frequency deviation,  $\Delta f$ , one must multiply the modulation index by the frequency of

modulation. If the modulation frequency is not known, it also may be determined from the spectrum-analyzer display because the frequency separation between the carrier and the first sideband is equal to the modulating frequency. In the illustration, since the modulation frequency is 10 kilohertz, the frequency deviation is  $10 \text{ kHz} \times 0.32$  or 3.2 kHz.  $\square$

## Scope-triggered register freezes serial data

by Matthew L. Fichtenbaum  
GenRad Inc., Concord, Mass.

The technique that uses the trigger and delay functions of an oscilloscope to latch a data bus at a particular time [*Electronics*, April 1, p. 103] may be extended to systems where data is transmitted or processed serially. Data from such systems as calculators and serial microprocessors may be easily captured and displayed under the control of a scope such as the Tektronix 465 or 475.

As shown in the figure, the hardware requires relatively few components. A serial-to-parallel shift register converts the serial data for display and serves also to count the bits that comprise a serial word. A second register stores the resulting parallel data and drives the light-emitting diodes that show the data. The circuit shown is for 8-bit serial words, but may be adapted for any word length by changing the number of bits in the two registers.

The scope should be operated in its A-intensified-by-B mode, with the A (main) sweep set to trigger on an event before occurrence of the data (any timing signal in the program). The B (delayed) sweep should be externally triggered by the same clock signal that shifts the serial

data. The B sweep's starting time, indicated by the start of the trace's intensified section, advances one clock pulse at a time as the delay-time control is advanced. Since this time is the start of the displayed serial word, data at successive system cycle times may be displayed by advancing the delay-time control to make the intensified trace begin at these times.

Before the triggering event occurs, the A-gate scope output is low, and the serial register is preset with a 1 in the first bit and 0s in the remaining bits. When the scope triggers, the A gate goes high, removing the clear signal, but the register remains in the preset state.

When the delay-time interval is complete, the B sweep is armed to be triggered, and it triggers synchronously with the clock in the system. When B triggering occurs, the B-gate output enables the system clock to shift the serial register, shifting in the serial data.

After the proper number of shift pulses (in this case, eight), the 1 that was preset into the first bit reaches the last bit of the serial register (the  $Q_H$  output of the 74LS164). This inhibits further shift pulses and forces the register to hold the 8 bits of data just gathered.

At the end of the scope sweep, the A-gate output goes low again. This loads the data from the serial register into the display register to drive the LEDs and sets the serial register to its initial state again. The cycle may then repeat when the next trigger event occurs.  $\square$

Engineer's notebook is a regular feature in *Electronics*. We invite readers to submit original design shortcuts, calculation aids, measurement and test techniques, and other ideas for saving engineering time or cost. We'll pay \$50 for each item published.

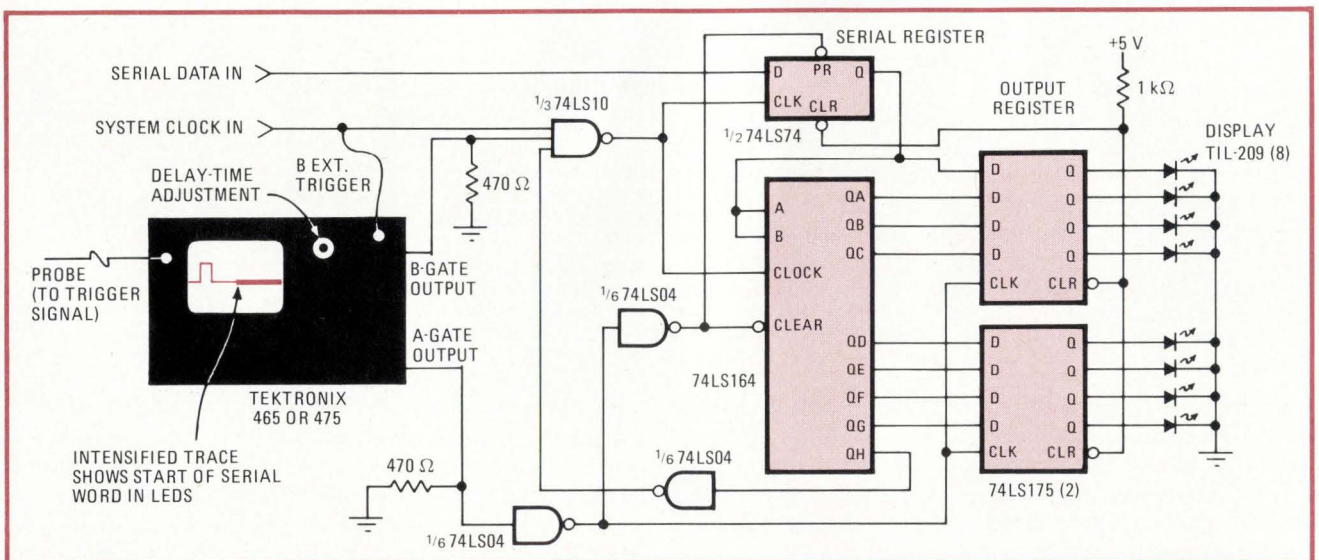

**Serial-data catcher.** Data from a microprocessor or other serial system is converted to parallel form and displayed on LEDs. Acquisition and conversion are controlled by timing signals from the oscilloscope; the convenience of delayed-sweep triggering is used to advantage.

# This complete 16K, 32K, 64K Memory Cycles in just 180 Nsec.

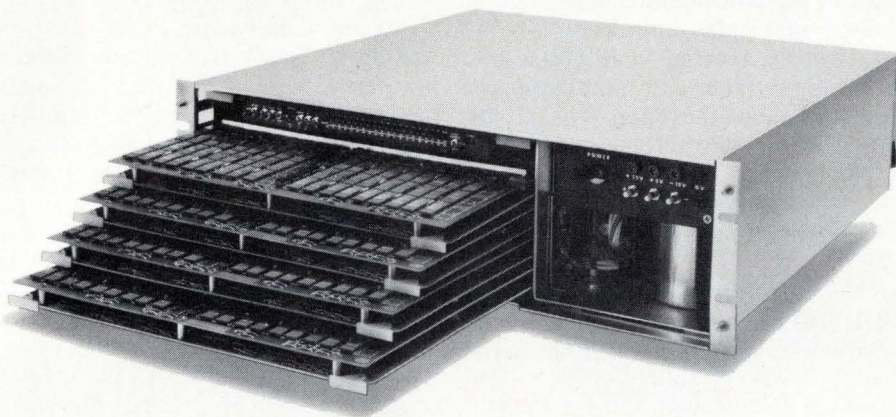

... and it's yours for less than 1¢ per bit!

It's the fastest standard system on the market with large capacity and TTL compatible interface, and it's conveniently packaged at a surprisingly low cost. It's the MICRORAM 3000N-1, a complete random access semiconductor memory system utilizing our own reliable, metal gate NMOS static RAM components.

The MICRORAM 3000N-1 provides a fast 180 nsec. cycle time and accesses at 150 nsec. It is expandable from 16K x 20 to 64K x 20 through the simple addition of plug-in memory cards. The system is completely self-contained, including power supply and cooling fans, in a 5¼" chassis designed for 19" rack mounting. And the entire package is available for less than 1¢ per bit. (If you don't need all that speed, consider the basic MICRORAM 3000N, which cycles at 300 nsec and accesses at 180 nsec.)

High performance. High capacity. Low cost. Immediate availability. We have them all. You can have them too. Call your local EMM office today for all the details.

**EMM** ELECTRONIC  
MEMORIES  
COMMERCIAL MEMORY PRODUCTS

12621 Chadron Ave., Hawthorne, California 90250 • (213) 644-9881

EMM OFFICES: Northern California, (408) 998-2668; Southern California, (213) 644-9881; Chicago Area, (312) 297-7090; New England, (617) 861-9650; New York Area, (516) 423-5800; United Kingdom, 01-751-1213.

## Circuit steps program for 8080 debugging

by John F. Wakerly  
Stanford University, Stanford, Calif.

Executing a program one step at a time is an important aid to debugging microprocessor systems. There are two basic approaches to providing a single-step capability. One method is to add hardware to provide a software interrupt after each instruction's execution, and the other is to provide a completely hardware-oriented "front panel" to give the capability to execute single instructions or memory cycles under hardware control.

With the first approach, the user can write an interrupt service routine that allows register and memory to be examined at the system teletypewriter or terminal between instruction executions [*Electronics*, June 24, 1976, p. 105]. It takes advantage of the full power and convenience of a software-debugging package, but instructions cannot be single-stepped if interrupts are disabled, and single memory-reference stepping is not possible (there may be several memory references per instruction, and interrupts cannot take place in the middle of an instruction).

The circuit described here is the hardware-implemented "front panel," which enables the user to execute 8080 microprocessor programs either one instruction at a time or one machine cycle (memory or input/output reference) at a time. The circuit uses the READY input of the 8080 to stop the program at each instruction or machine cycle, as selected by the user. A push button then runs the program one step at a time. Between steps, the user can observe the machine state and the current

instruction or data on the 8080 data, address, and control lines with a scope, logic probe, or permanent indicator lamps.

The single-step circuit shown in Fig. 1 assumes that an 8224 clock generator is used with the 8080. Without the single-step circuit, a ready signal (SYSREADY H) generated by the memory and I/O systems would be connected to the 8224 RDYIN input. For single-stepping, SYSREADY H (where H denotes active high) is ANDed with the signal GO H. If either signal is low during a memory or I/O reference, the 8080 will go into a wait state until both signals become high. If this circuit is used in a system that does not generate SYSREADY H, then the AND can be removed and GO H connected directly to RDYIN.

A 7474 edge-triggered D-type flip-flop, FF<sub>2</sub>, generates the GO H signal. Proper operation of the circuit depends on the fact that a low input on the PR input of the 7474 produces a high output at Q, regardless of any of the other inputs, including CLR. (If both PR and CLR are low, then both Q and  $\bar{Q}$  are high.) Thus, if STOP H is low, GO H is high, and the 8080 executes instructions at full speed. However, the 8080 holds WAIT H low just before every memory or I/O reference; thus, if STOP H is high, FF<sub>2</sub> is cleared by the low signal on WAIT H, the 8080 enters the wait state, and instruction execution is stopped. In the wait state, WAIT H goes high and allows GO H to be set high again by clocking FF<sub>2</sub> with the STEP H input. STEP H is the output of a single-step push button, and instruction execution does not begin until this button is pushed.

If only single-stepping at each machine cycle were desired, STOP H could be obtained from a simple switch to select normal operation or single-stepping. However for single instruction stepping, FF<sub>1</sub> is used to detect the beginning of each instruction cycle—the instruction fetch. At the beginning of each machine cycle, the 8080 places a signal M1 H on data-bus output D<sub>5</sub> which

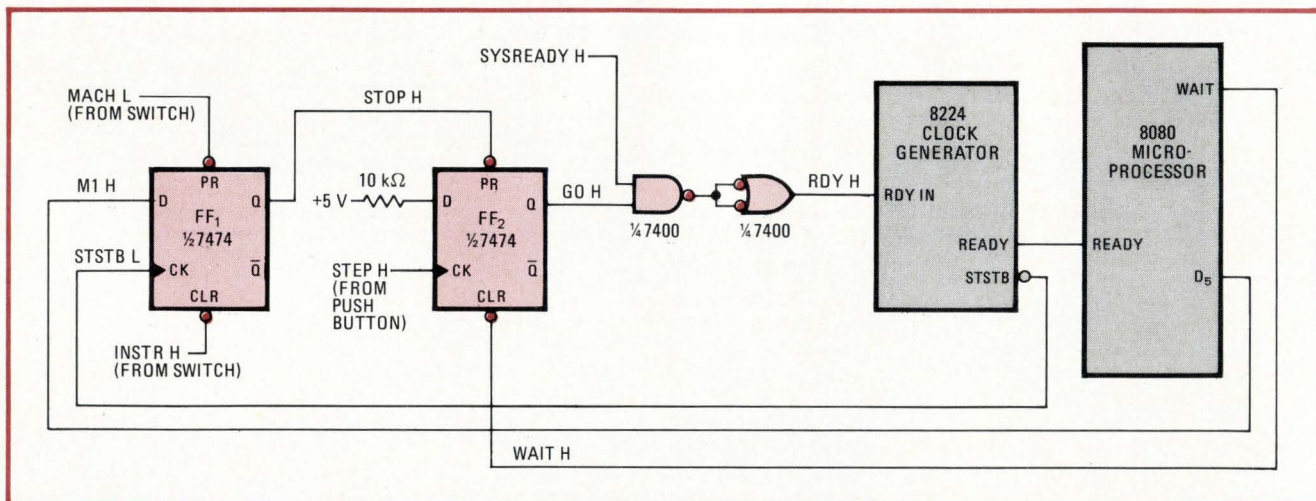

**1. Single-step circuit for 8080.** This circuit requires only one 7474 dual D flip-flop and half of a 7400 quad NAND package to provide single-instruction and single-machine-cycle-execution capability for an 8080 microprocessor system. It can be modified for a Zilog Z-80.



indicates the first machine cycle (fetch) of an instruction. This signal is clocked into FF<sub>1</sub> by STSTB L; thus if M1 H is high, STOP H becomes high, and the 8080 is stopped during the instruction fetch. The data bus contains the fetched instruction.

The PR and CLR inputs of FF<sub>1</sub> are used to determine the mode of operation. If MACH L is asserted (low), STOP H is held unconditionally high, and the 8080 stops at each machine cycle. If MACH L is de-asserted and INSTR H is asserted (high), then M1 H is clocked into FF<sub>1</sub> to generate STOP H, and the 8080 stops at every instruction cycle. If both MACH L and INSTR H are de-asserted, then STOP H is held low, and the 8080 operates normally.

If the inputs MACH L, INSTR H, and STEP H are obtained from switches, they should be debounced. Figure 2 shows an economical debouncing circuit that uses a pair of inverters to debounce a single-pole, double-throw switch. The circuit shorts the high output of an inverter to ground for about 20 nanoseconds at each transition, but this short is not harmful.

An advantage of this circuit over conventional cross-couple NAND gates for debouncing is that three switches can be debounced with one 7404, as opposed to two with one 7400. Also, no pull-up resistors are used.

The single-step circuit can be easily modified for use

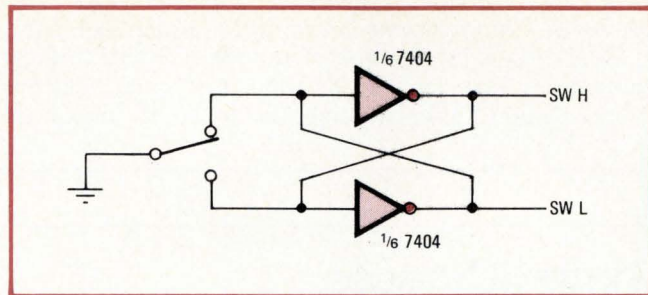

**2. Switch-debouncing circuit.** Part of a 7404 package debounces spdt switch. Signals are active when switch has position shown.

with the Zilog Z-80 microprocessor. The Z-80 has a separate output pin for  $\bar{M}1$ , which should be connected to the D input of FF<sub>1</sub>. Since this polarity is the opposite of the 8080 M1 output, the STOP H signal should be obtained from the  $\bar{Q}$  output of FF<sub>1</sub>, and the PR and CLR inputs should be reversed. FF<sub>1</sub> should be clocked by the Z-80 input clock  $\Phi$ , and the RDY H signal should be connected to the WAIT input of the Z-80. Finally, the CLR input of FF<sub>2</sub> should be connected to  $\overline{MREQ + IORQ}$ , which can be obtained from the  $\overline{MREQ}$  and  $\overline{IORQ}$  outputs of the Z-80 with a single 2-input NAND gate (one quarter of a 7400 package). □

## C-MOS reset circuit ignores brief outages

by Roger F. Atkinson  
ITEC Inc., Huntsville, Ala.

If the voltage supply to a C-MOS circuit drops much below 3 volts during a power failure, a reset signal is necessary to initialize the logic and perhaps also to indicate that the power has failed. But, unlike conventional power-fail circuits, the reset should ignore transient interruptions that do not drop the supply below 3 volts, the level at which the logic states of the latches, counters, and the like may change randomly.

Such a reset signal can readily be derived. An isolated reference voltage is applied to the input of a Schmitt trigger having threshold voltages that are a function of the logic-supply voltage.

In the complementary-metal-oxide-semiconductor circuit shown, the Schmitt trigger is a National MM74C14. Diodes D<sub>1</sub> through D<sub>4</sub> and resistor R<sub>1</sub> establish a reference voltage of approximately 2.5 volts across capacitor C<sub>1</sub>. D<sub>5</sub> isolates the energy-storage capacitor C<sub>2</sub> from the supply and from any higher-current loads such as relays and displays that are not needed during a power failure. D<sub>6</sub> assures that the reference cannot exceed the supply voltage by more than one diode drop.

When power is first applied, C<sub>2</sub> is at zero volts. As C<sub>2</sub> charges through D<sub>5</sub> and R<sub>2</sub>, the reference at first exceeds the high threshold of the Schmitt trigger, causing its output to go low and thus resetting associated circuits.

This signal remains low until the logic supply voltage (across C<sub>2</sub>) is high enough (about 8 v) for the low threshold to exceed the reference and to switch the Schmitt high. During subsequent power failures—provided the logic supply voltage across C<sub>2</sub> remains above 3 v—the high threshold (about 80% of supply at low voltages) will remain above the reference, so that the Schmitt output will not switch when power is reapplied. However, should the supply fall so low that the high threshold is lower than the reference when power is restored, the Schmitt output will go low, thus resetting

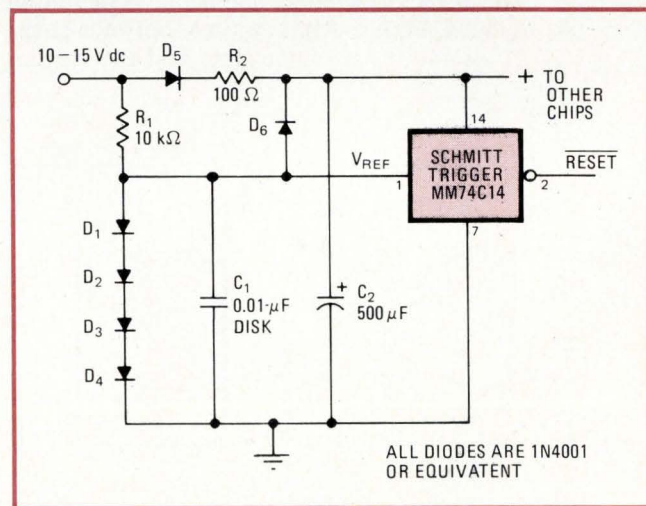

**Resets if necessary.** During brief interruptions of dc power, the charge on C<sub>2</sub> maintains voltage to C-MOS digital circuits, preserving their logic states. But if the power failure lasts so long that the voltage across C<sub>2</sub> drops below 3 V, the Schmitt trigger resets the logic circuits when power is restored.

the logic. The reset can activate a warning indicator.

$R_2$  and  $C_2$  delay the rise of the logic-supply voltage, controlling the length of the reset pulse. Other C-MOS Schmitt circuits might be used. To maximize

endurance during power outages, resistive loads on the C-MOS outputs should be avoided. The circuit shown allows an MM74C193 up/down counter to retain its count for more than 10 minutes. □

## Timer IC paces analog divider

by Kamil Kraus  
Plzen, Czechoslovakia

The quotient of two analog voltages,  $V_x/V_y$ , is required in many control and computation applications. This ratio can be produced by a circuit that consists of a voltage-to-frequency converter and an amplitude modulator, as shown in the accompanying diagram.

In the V-to-f converter, input voltage  $V_y$  drives a field-effect transistor through an operational amplifier. The FET operates as voltage-controlled resistor to determine the frequency of a 555-timer astable multivibrator. The resistance of the FET is given by:

$$R = V_p^2 / [(1 + R_1/R_2)I_sV_y - I_sV_p]$$

where  $V_p$  is the FET threshold and  $I_s$  is the drain current when  $V_y$  is zero.

In this mode of operation, the capacitor  $C$  charges and discharges between  $1/3$  and  $2/3$  of  $V_{CC}$ . Thus the output voltage of the timer varies from 5 to 10 volts if the supply is 15 v. The charge and discharge times and therefore the frequency are independent of the supply voltage.

Input voltage  $V_x$  is applied to the inverting input of op amp  $A_2$ , which acts as the amplitude modulator. When the output from the timer (pin 3 of the 555) goes high, transistor  $Q$  turns on and grounds the noninverting input of  $A_2$ , so that the output from  $A_2$  is  $-V_x$ . When the

timer output is low, transistor  $Q$  is off and the output from  $A_2$  is  $+V_x$ .

The output from  $A_2$  is therefore  $-V_x$  during the charging time of the timer:

$$t_c = 0.693(R + R_B)C$$

and is  $+V_x$  during the discharge time of the timer:

$$t_d = 0.693R_B C$$

The average value of the output voltage from  $A_2$  over the period of the timer is given by:

$$\bar{V}_{out} = V_x(t_d - t_c) / (t_c + t_d)$$

Substitution of the expressions for the charge and discharge times, and use of the relation for  $R$ , yield:

$$\bar{V}_{out} = -V_p V_x / (1 + R_1/R_2) V_y$$

if  $R_B$  is made equal to  $V_p/2I_s$ . For the 2N4222 FET,  $V_p$  is 15 volts and  $I_s$  is 15 mA, so  $R_B$  is 500  $\Omega$ . The value of  $C$  is 0.01 microfarad, as recommended by the 555 manufacturer. If the value of  $R_1$  is  $14R_2$  as shown, the average output voltage, in volts, is:

$$\bar{V}_{out} = -V_x/V_y$$

Thus the mean value of the output voltage from  $A_2$  is numerically equal to the ratio of input voltages  $V_x$  and  $V_y$ . These voltages can have any values in the range from 0 to +10 v; the average of the output can be realized with an RC across the output circuit, or read on a damped voltmeter, or whatever the application requires. □

Designer's casebook is a regular feature in Electronics. We invite readers to submit original and unpublished circuit ideas and solutions to design problems. Explain briefly but thoroughly the circuit's operating principle and purpose. We'll pay \$50 for each item published.

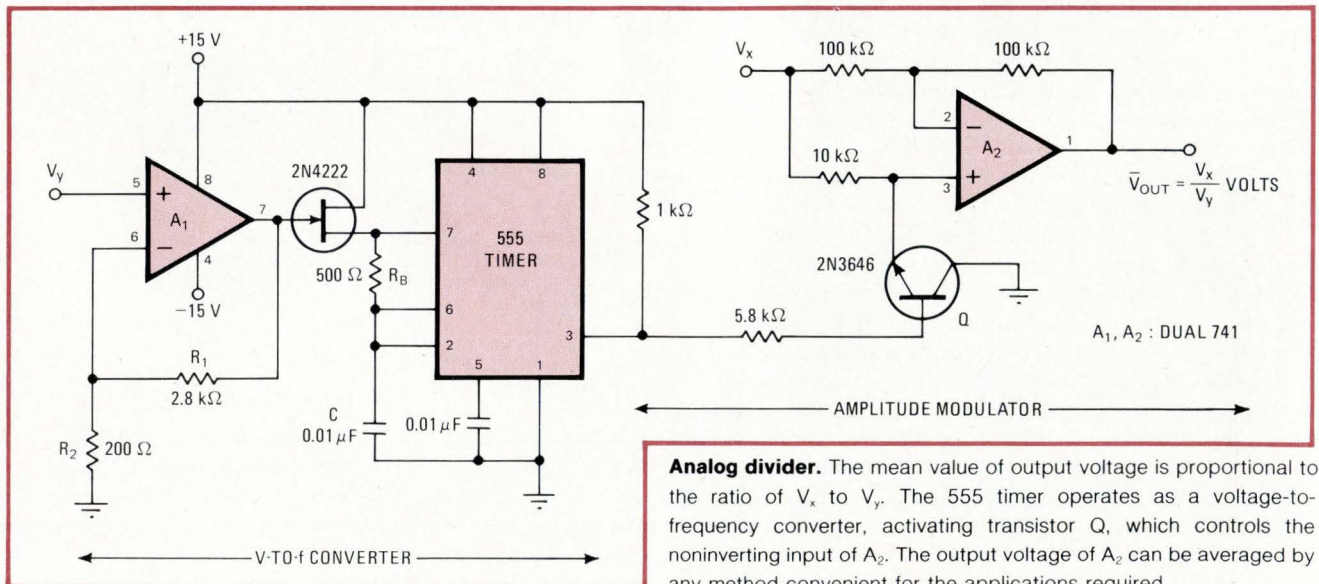

**Analog divider.** The mean value of output voltage is proportional to the ratio of  $V_x$  to  $V_y$ . The 555 timer operates as a voltage-to-frequency converter, activating transistor  $Q$ , which controls the noninverting input of  $A_2$ . The output voltage of  $A_2$  can be averaged by any method convenient for the applications required.

# WE'RE WARNING YOU...

... no better audio indicators are available for fire and burglar alarms. Seven models ... continuous tone, or fast or slow pulsing, or all three ... to 100 dbA at 2.7 kHz depending on voltage ... some rated to 85 dbA at ten feet. White, 3.54" diameter x 1.42" high (90 x 36mm). 50mm diameter piezo crystal. Wire leads. Mounts easily on wall or panel with screws. Ask for new free catalog.

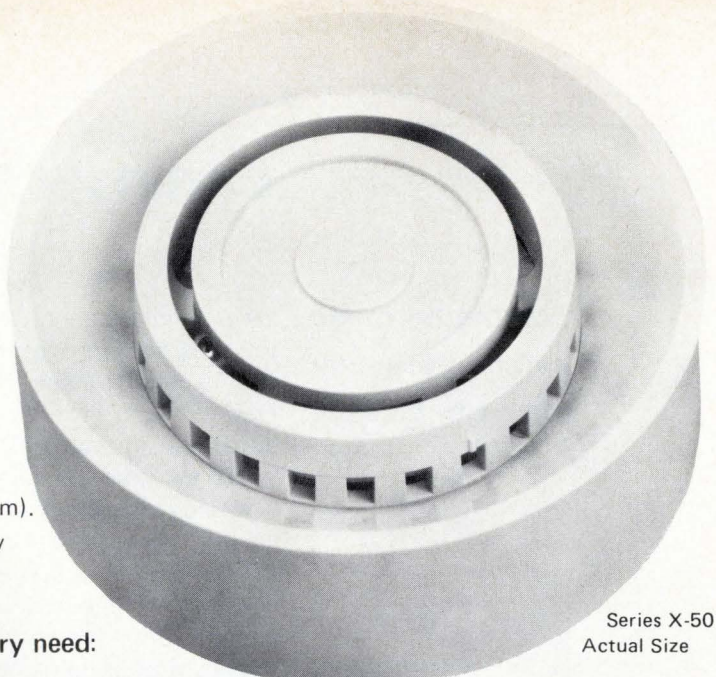

Series X-50  
Actual Size

**Where to buy** an audio indicator for every need:



**projects<sup>®</sup>  
unlimited**

3680 Wyse Road, Dayton, Ohio 45414  
Tel. (513) 890-1918, TWX 810-450-2523

*Selected distributorships available.*

**CALIFORNIA, COSTA MESA**  
MarVac Electronics

**MASSACHUSETTS, SHARON**  
Adcour

**MICHIGAN, FARMINGTON**  
CMP Distributor Co.

**NEW YORK, ROCHESTER**  
Ossmann Components

**OHIO, CLEVELAND**  
CMP Distributor Co.

**OHIO, CINCINNATI  
COLUMBUS**  
Hughes Peters, Inc.

**TEXAS, DALLAS**  
K. A. Electronics

**UTAH, SALT LAKE**  
Newark Electronics

**WASHINGTON, SEATTLE**  
Frank Jackson & Associates

**WISCONSIN, MILWAUKEE**  
Taylor Electric

**ONTARIO, WILLOWDALE**  
Electro Sonic, Inc.

**B. C., VANCOUVER**  
Deskin Sales Corp.

For Product Information to be sent circle 113 on Reader Service Card  
For Representative to call circle 149 on Reader Service Card

## COMMUNICATION FIBEROPTICS

### CABLES AND DATA LINKS

#### RUGGED REINFORCED CABLES

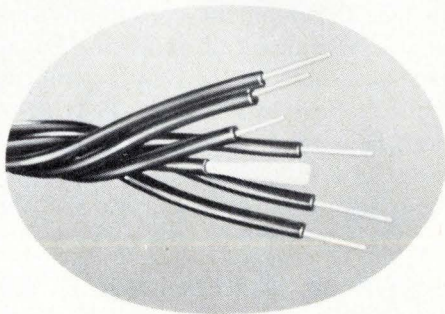

Single Channel or Multi-Channel  
Single-Fiber Channels or Bundles  
... Cost competitive with  
coaxial cable.

#### LOW LOSS

< 10 dB/Km  
Graded Index  
Step Index  
Single Mode

#### MEDIUM LOSS

20-40 dB/Km  
Radiation-Hard Silica

#### HIGH LOSS

400 dB/Km Bundles

#### ELECTRO-OPTIC LINKS

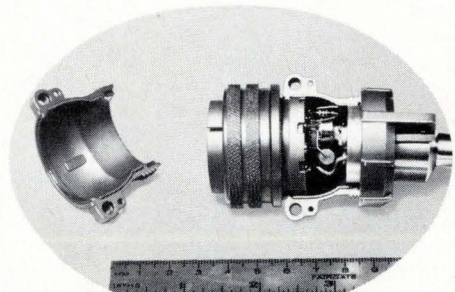

Custom Designed  
Bandwidths to 20 mHz  
Lengths to 2 Km

**VALTEC**

WEST BOYLSTON MA 01583 617-835-6082

Circle 150 on reader service card

## Engineer's newsletter

---

### **Making hermetic ceramic-to-metal seals can be easy**

Two Sandia Laboratories scientists, Paul Wilcox and Gary Snow, have invented an improved method for making ceramic-to-metal hermetic seals. It's covered by patent No. 3,951,327, assigned to the Energy Research and Development Administration, which essentially puts it in the public domain—simply write to ERDA for permission to use it.

Here's how it works: after chemically cleaning the surface of the ceramic members, you put a wire-like metal gasket directly on one of the ceramic parts (no pre-metalization is needed) and **heat the entire assembly till the gasket is soft enough to deform when the two ceramic members are pressed together.** The gasket material should be related to the ceramic composition—for instance, an aluminum gasket would be suitable for sealing aluminum oxide. The procedure has been used at the Albuquerque, N.M., site for sealing quartz crystals in a ceramic flat-pack.

### **Wescon will bend your ear on microprocessors**

Although the Sept. 2 issue of *Electronics* will carry a full preview of the upcoming Wescon technical program, it's worth noting even earlier that the Sept. 14–17 meeting in Los Angeles will be laden with papers on microprocessors. In particular, there will be some interesting discussions of **both the military's efforts to standardize microprocessor types and trends in bipolar bit-slice devices.** Two recently announced commercial minicomputers are based on the bit-slice types—Harris Corp.'s Slash/6 and Interdata's  $\frac{5}{16}$ , which both use Advanced Micro Devices 2901 devices—and nearly every other minicomputer manufacturer is now studying the devices. The Wescon bit-slice session will include papers from four producers of the devices—Fairchild, AMD, Intel, and Monolithic Memories. Others include Texas Instruments and Motorola, which recently announced its emitter-coupled-logic high-speed device, the 10800.

### **Pythagoras and the hypotenuse . . . again**

It seems that there are any number of ways to solve for the square root of the sum of two squared signals. Engineer's Newsletter has already carried three schemes [Sept. 18, 1975, p. 56, and Nov. 13, 1975, p. 142] involving amplitude modulation, logarithms, and a combination of multiplication, division, and summing amplifiers.

Now, D.P. Franklin, a research and development consultant for the Systems and Weapons division of EMI Electronics Ltd. in Wells, England, has reminded us that more than seven years ago, in the British publication *Electronic Engineering* (Jan. 1969, p. 63), he described how **the tried-and-true diode function generator can also be used.** It produces an output that is a piecewise-linear approximation of the desired function. However, even without an excessive number of linear segments, he says, you can obtain moderate accuracies—say, to within 1%.

### **Program note**

In the June 12, 1976, *Engineers Notebook*, Dan Sheingold of Analog Devices gave a procedure for calculating the resistances used in sum and difference networks. Now, he's written **a program for the HP-25 calculator that computes the resistances for up to three positive terms and three negative terms.** For a copy of the program, see *Analog Dialogue*, Vol. 10, No. 1, published by Analog Devices Inc., P.O. Box 280, Norwood, Mass. 02062.

—Stephen E. Scrupski

**SIEMENS**

# When your reputation's riding on the quality of your 4K RAM's, Siemens 203 is the one test system to own. Ask Mostek — they own ~~five~~ *ten* *eight*.

Mostek demanded high-throughput yet thorough testing for their 4K RAM's. They also wanted fast delivery. Siemens provided the answer—a semiconductor memory tester which delivered the performance they needed. And delivered it on time.

The 203 Semiconductor Memory Device Test System is a new, powerful tool for evaluating the performance of RAM's, ROM's and Shift Registers in production, engineering, and incoming inspection. The system satisfies all aspects of high-speed functional and DC-parametric testing requirements to provide total test flexibility and lowest cost-per-unit throughput.

The microprogrammable processor in the 203 generates address sequences and data patterns at true 20 MHz test rates, enhancing its use for future high-speed devices. Multi-cycle timing is provided by 16 independently programmable channels.

A high-resolution 1 NS clock permits meaningful time-related device tests, ensuring accurate, repeatable test results.

The 203 Test System is totally unique in the semiconductor memory test field. It offered Mostek an unmatched test capability at the least overall cost; it can do the same for you. Today and tomorrow.

## **Siemens Corporation Computest Products**

3 Computer Drive, Cherry Hill, N.J. 08034 (609) 424-2400

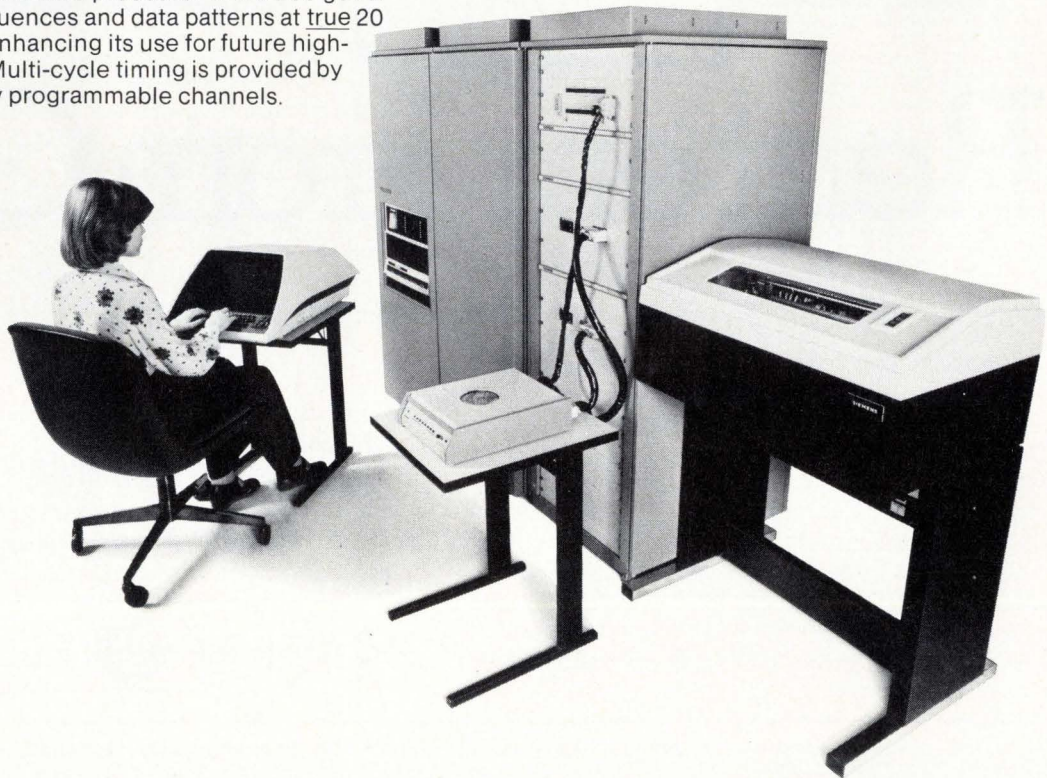

# You Don't Have To Beg, Borrow Or Buy...

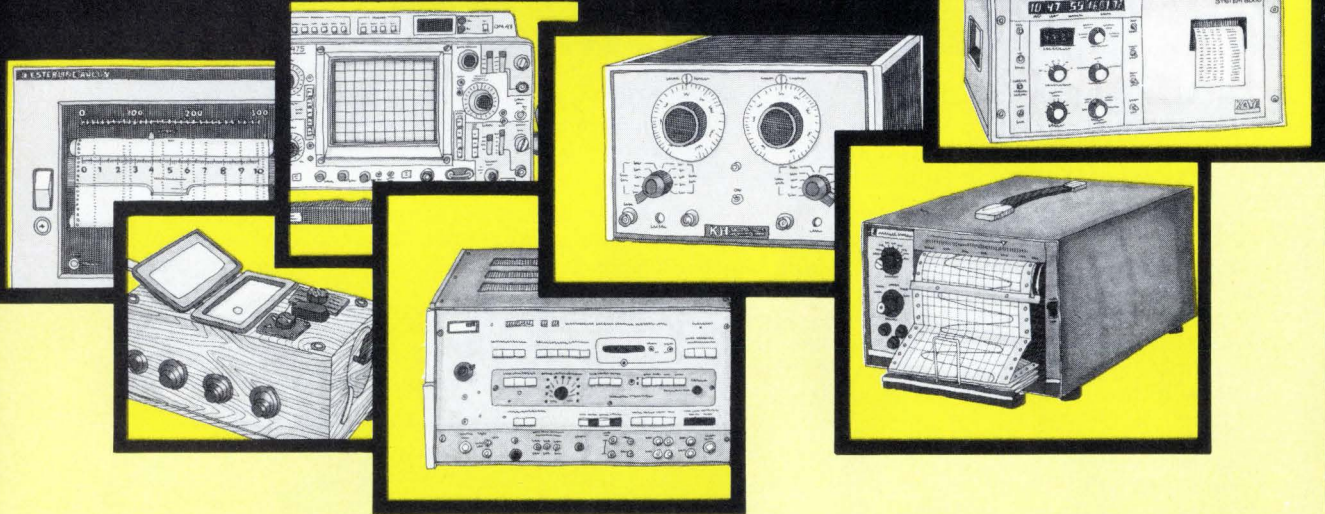
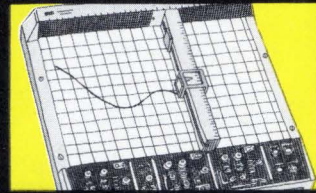

## Rent 'em From GE

Short or long-term instrument rentals give you flexibility and economy.

GE has over 9,000 instruments available for immediate shipment: □ Tek Scopes □ Bidle Megger Insulation Testers □ H-P Signal Generators □ Honeywell Oscillographs □ Complete Data Systems □ Esterline Angus Recorders □ GE Chart Recorders □ Modems □ Communication Terminals . . . all calibrated to the manufacturer's specs.

We have over 100 Sales/Service Centers, and one of them is near you. In addition to maintaining our Rental Inventory, they can also repair and calibrate your own equipment.

Don't borrow someone else's GE Rental Catalog. **Call collect (518) 372-9900** or your nearest Sales/Service Center.

**Quick·rental<sup>\*</sup>**  
**instruments**

\*Trademark General Electric

**GENERAL  ELECTRIC**

**ALA.** BIRMINGHAM (205) 925-3101 • **ARIZ.** PHOENIX (602) 278-8515 or 8516, TUSCON (602) 294-3139 • **CAL.** LOS ANGELES (213) 674-7900, SAN FRANCISCO (415) 436-9260 • **COL.** DENVER (303) 371-1260 • **CONN.** SOUTHINGTON (203) 261-4059 • **FLA.** JACKSONVILLE (904) 751-0610 • **GA.** ATLANTA (404) 458-2231 • **ILL.** CHICAGO (219) 933-4500 • **IND.** INDIANAPOLIS (317) 639-1565 • **KY.** LOUISVILLE (502) 452-3311 • **LA.** NEW ORLEANS (504) 367-6528 • **MD.** BALTIMORE (301) 837-4500 • **MASS.** BOSTON (617) 396-9600 Ext. 160, SPRINGFIELD (413) 781-1111 • **MICH.** DETROIT (313) 285-6700 Ext. 212 or 209 • **MINN.** MINNEAPOLIS (612) 522-4396 • **MO.** KANSAS CITY (816) 231-4377, ST. LOUIS (314) 342-7835 • **N.J.** CLIFTON (201) 471-6556 • **N.Y.** BUFFALO (716) 876-1200, SCHENECTADY (518) 385-2195 • **N.Y.C.** CLIFTON, N.J. (201) 471-6556 • **N.C.** CHARLOTTE (704) 525-0311 • **OH.** CINCINNATI (513) 874-8512, CLEVELAND (216) 523-6382, TOLEDO (419) 691-3501 • **OR.** PORTLAND (503) 221-5101 • **PA.** PHILADELPHIA (609) 424-4450, PITTSBURGH (412) 462-7400 • **TEX.** DALLAS (214) 357-7341, HOUSTON (713) 672-3569 • **VA.** RICHMOND (804) 232-6733 • **WASH.** SEATTLE (206) 854-0211 • **W.V.** CHARLESTON (304) 346-9421 • **WISC.** MILWAUKEE (414) 744-0110 • **PUERTO RICO** PONCE (809) 843-4225.

## New products

# Calculator runs transceiver tester

System using off-the-shelf equipment and IEEE interface bus checks out citizens' band, police, fire, and other types of radio up to 1,000 MHz

by Bernard Cole, San Francisco bureau manager

**Sales and production** of radio transceivers for use below 1,000 megahertz are reaching new records. Although much of this increase results from the new popularity of citizens' band radio, most other transceiver markets are also strong—among them, police, fire, and commercial fm, as well as avionics and military.

But production costs are also continuing in an upward direction, and, in an attempt to stabilize these costs, many makers of radio transceivers are looking increasingly to test-automation. The choices to date, however, have been limited to two primary alternatives: high-volume-oriented, general-purpose, minicomputer-controlled test systems costing about \$150,000, but flexible enough to work over a wide range of test conditions, and calculator-controlled special-purpose fixed hardware systems costing only \$45,000 to \$60,000, but more limited in their range of test conditions [*Electronics*, Nov. 13, 1975, p. 149].

**Flexibility and low cost.** By utilizing mostly off-the-shelf test equipment, along with some specially designed interface hardware using the IEEE instrument-interface bus, Hewlett-Packard has developed the \$58,500 calculator-controlled 8950A transceiver test system, which combines the flexibility of the general-purpose minicomputer-controlled systems with the low cost of the special-purpose fixed-hardware systems. The combination of these instruments—the 8660A signal generator, the 436A power meter, the 3490A digital voltmeter, the 5345A counter, and the 3320 synthesizer—provides the capability of testing a-m

and fm transceivers up to 1,000 MHz, covering the important new 900-MHz mobile fm band for which a considerable increase in activity is forecast. By contrast, present testers cover frequencies up to only 500 MHz. All instruments are linked through the digital interface bus for control and data. System control, says product marketing manager George Skidmore, is via the HP9830A calculator [*Electronics*, Jan. 22, p. 142].

Transmitters with output frequencies from 1 to 1,000 MHz and powers from 1 to 100 watts can be measured, says James Stinehelfer, project leader. An internal high-power attenuator is included for system self-calibration. Amplitude-modulation characteristics are measured from 1% to 95% depth and to

an accuracy within  $\pm 3\%$ . Audio output characteristics of the transmitter provide for accuracy within  $\pm 5\%$  on audio sensitivity, with audio indicated to 25 kHz for a-m and 20 kHz for fm. Audio distortion is measured to within  $\pm 2\%$  at 1 kHz by means of the total-harmonic-distortion technique. Squelch-tone frequency indication to  $\pm 1$  Hz and hot-mockup primary power to 30 amperes are standard.

Receiver-test capabilities, says Skidmore, include sensitivity tests at 12 dB sinad (signal plus noise and distortion) for 1 kHz or with 20 dB quieting, and they can also be made at squelch threshold. Audio power output is measured to  $\pm 5\%$  with a frequency response to 50 kHz; accuracy and audio distortion to

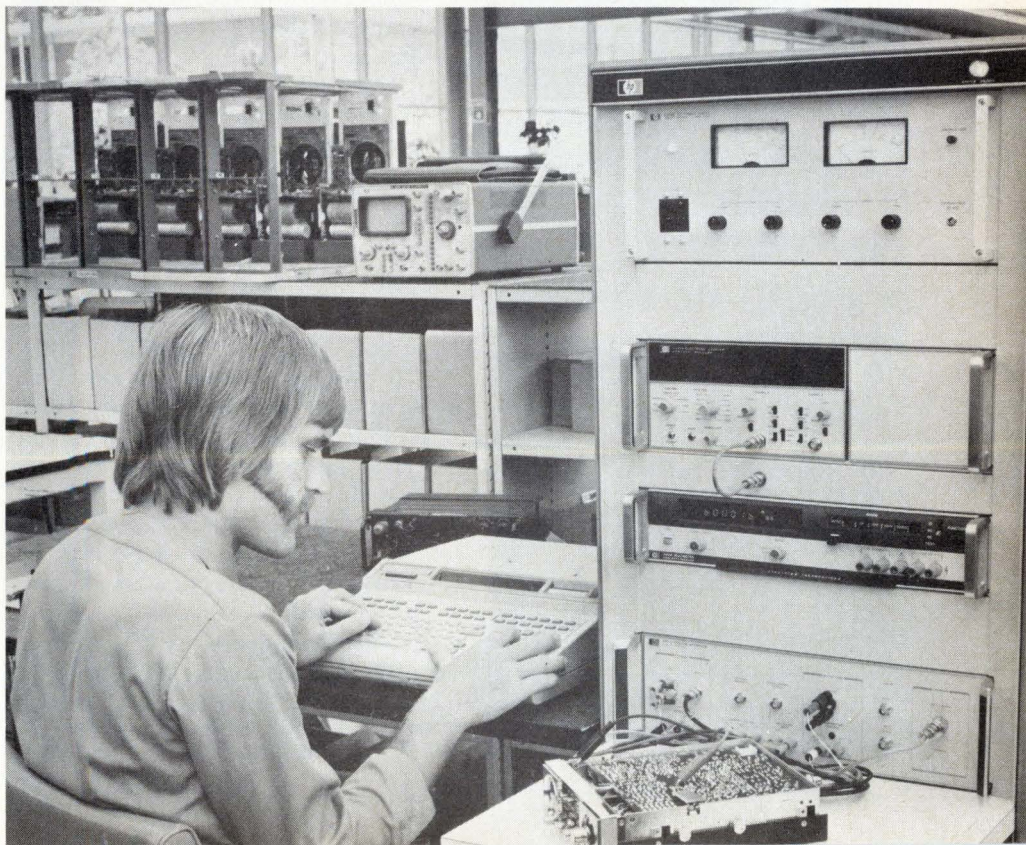

# ONE-UP MICROPROCESSORS WITH A SINGLE-CHIP MICRO-SYSTEM

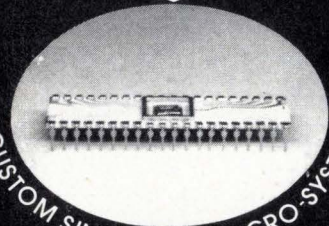
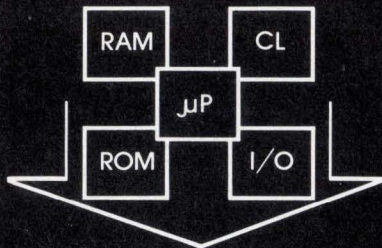

CUSTOM SINGLE-CHIP MICRO-SYSTEM

Microprocessor, Memory, I/O and Clock on the same chip optimized to your needs including special instruction set.

Non-Microprocessor functions such as special Counters, Timing, Multiplexers, UARTS, FIFOS, A/D, etc, can be included on same chip.

Performance proven by breadboard simulator.

Proprietary to you - you own the tooling.

PMOS, NMOS, or CMOS.

Guaranteed prototype development - with or without production commitment.

Guaranteed multiple manufacturing sources.

Contact us today for full details.

**ALPHATRON, INC.**

10340 BUBB ROAD  
CUPERTINO, CALIFORNIA 95014

• TEL. (408) 446-1494

## New products

$\pm 1\%$  at 1 kHz tone, and power is provided to 30  $\mu$  for the receiver under test. System modulation-acceptance bandwidth is 20 kHz.

The model 8950A achieves maximum throughput and testing speed with a special interface and signal switch-adaptor panel mounted at the operator's shelf. With convenient access to other work-table arrangements, transceiver signals are switched to and from the appropriate system-test instrument. And primary power connectors at the panel allow specialized wiring harness to be interfaced at one place.

The fact that the 8950A uses a rack of mostly off-the-shelf instruments to achieve its performance may sound like a trivial distinction, but actually, says Stinehelfer, the user gets substantial performance flexibility as compared with the fixed-hardware system. "In a dedicated installation devoted to a single continuous production run, this advantage would not be too significant," he says, "but no modern industrial strategy or product remains the same forever. Product change, specifications, and measurement requirements usually get tighter, and new frequency bands and modulations come into the picture." And in most of the applications, the flexibility should be very attractive, he says.

**Extendable.** For example, Skidmore points to the 8660A signal generator, which can be easily extended to higher frequencies (up to 2,600 MHz) or to more sophisticated modulations (phase modulation, for one) as required. The 436 power meter, with the simple addition of other power sensors, can extend its measurements to 18 GHz, -70 dBm or 75-ohm systems. The 3490 DVM can serve as a flexible data-acquisition instrument under calculator control. Internal voltages of radios may be probed, or current and resistance values obtained. Non-radio test functions may also be envisioned, he says, such as environmental testing of battery drift in a qualification laboratory.

The 5345A counter, although only used in its 500-MHz mode, can also

measure 2-nanosecond time intervals, pulsed rf, event ratios, and periods. A wide variety of plug-ins convert the 5345 for measurements to 18 GHz. The 3320, a 13-MHz synthesizer, offers general-purpose flexibility, says Stinehelfer, for a variety of other tests on radios and their components. Filters, circuits, and audio subassembly modules, he says, could all be tested by a combination of the 3320 and the DVM, and the range of 0.1 Hz to 13 Hz covers most circuits in typical radio modules. "For a large-volume user, these additional capabilities may not be too important," says Skidmore, "but for the medium-volume manufacturers, distributors, and service centers, this allows for amortization of the cost over a wider range of applications."

"It's too easy to say software gives ultimate flexibility to the user," he says. "But it's true." For example, a hardware fixed system might have a push button for sinad measurements, but that's all it does, because it was only designed for sinad. In the HP8950A, sinad is measured by a software subroutine of iterative measurements using mostly the system DVM and generator. The subroutine is supplied as a debugged test routine and may be used as is, or modified for changes. HP furnishes test-sequence software modules as demonstration subroutines segmented by type of test. The user then writes simple programs to sequence the tests as appropriate and check test data against programed limits or print out a test card. But beyond the supplied subroutines, says Stinehelfer, the calculator-based 8950A provides the capability to call on a variety of powerful computation routines, analyze data, store on cassette, print out, or tie in with higher-level management data bases in the factory.

Available now, the basic system, including the calculator, is priced at \$58,500. A printer that is sold as an option and is designated the model 9871 costs \$3,475.

Hewlett-Packard Co., Stanford Park Division, 1501 Page Mill Rd., Palo Alto, Calif. 94304 [338]



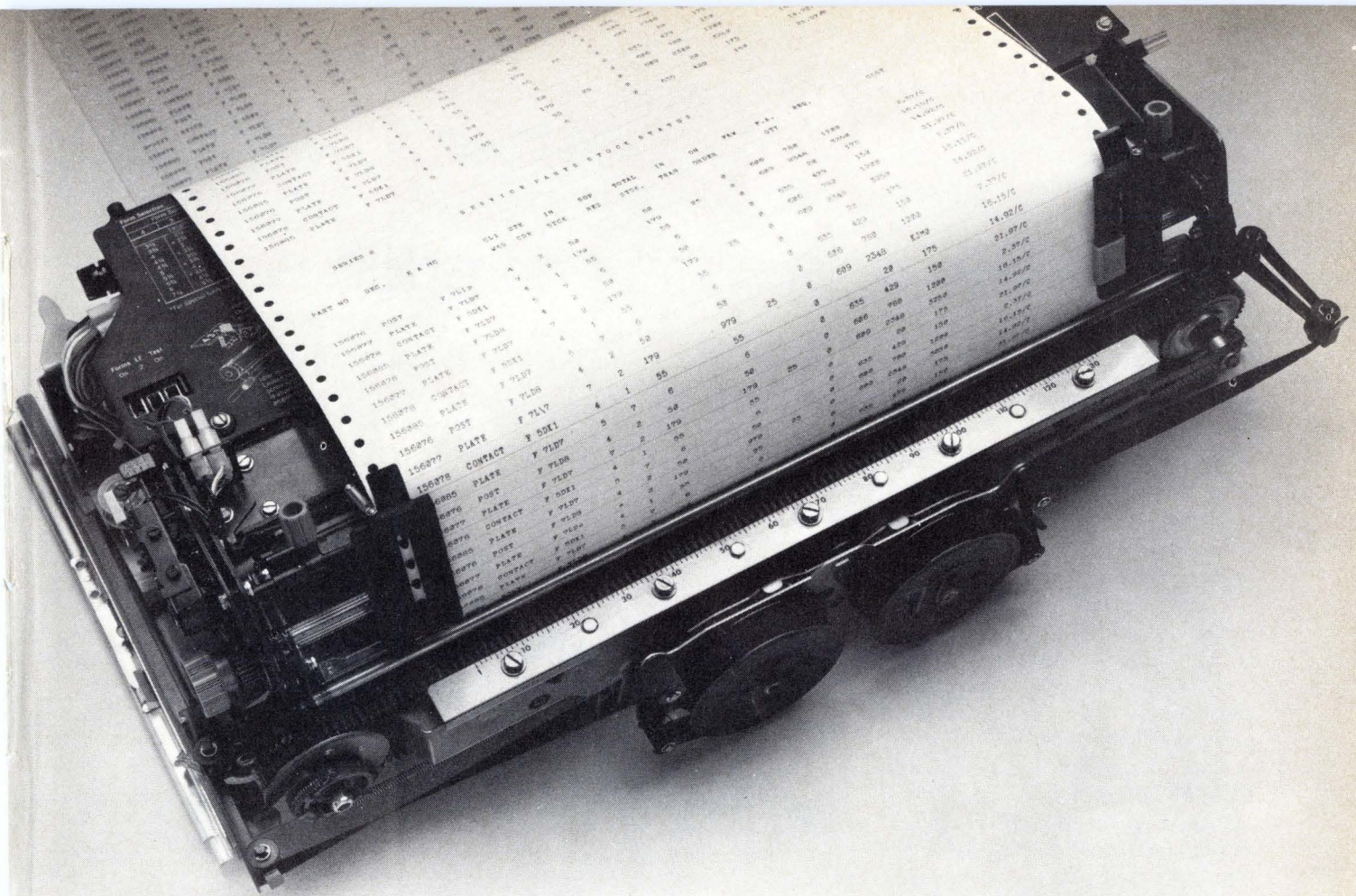

**The Teletype® model 40 OEM printer.  
When you look at it from price and performance,  
you'll find it difficult to look at anything else.**

The fact of the matter is simply this:  
We don't think any other printer can even come close to the model 40.

And that's no idle boast. Not when you consider the facts.

Consider: Where else can you get a 132-column, heavy-duty impact printer that delivers over 300 lines per minute for less than \$2000, or an 80-column printer for under \$1400?

The big reason behind the model 40's price/performance advantage is our unique design.

Even though it operates at speeds of more than 300 lpm, wear and tear is less than you'd find in a conventional printer operating at considerably slower speed. Fewer moving parts and solid-state components add up to greater reliability and reduced maintenance.

Here's something else to consider: Where else can you get a printer that delivers the kind of flexibility and reliability the model 40 offers?

For complete information, please contact our Sales Headquarters at: 5555 Touhy Ave., Skokie, Ill. 60076. Or call Terminal Central at: (312) 982-2000.



**The Teletype model 40 OEM printer.  
Nothing even comes close.**

## Solid-state relays drop in price

New families of ac devices covering 0.75 to 25 amperes and dc models ranging from 0.5 to 10 amperes challenge electromechanical units

by Lawrence Curran, Boston bureau manager

In ac and dc switching circuits, solid-state relays are usually chosen over electromechanical units when long life is needed or when radio-frequency interference must be held to a minimum. Traditionally, however, solid-state relays have been considerably more expensive than electromechanical types, generally costing several times as much. But, through what might be termed rather unconventional designs, a young firm named Theta-J Relays is rapidly bringing the prices of solid-state devices closer to those of electromechanical units.

Only about a year old, the fledgling company is now offering what Edward T. Rodriguez, chairman and technical director, calls a supermarket of solid-state relays. The new family includes ac devices rated from 0.75 to 25 amperes and dc models covering 0.5 to 10 A. All the new relays sell for at least half the price of existing comparable units, Rodriguez notes.

**New designs.** For most types, the choice of control-voltage inputs includes: 4–8 v dc, 9–15 v dc, 16–32 v dc, or 120 v ac nominal. Control current is typically 15 milliamperes, making the units compatible with transistor-transistor logic. Output voltage ratings go up to either 280 v ac or 250 v dc.

"We're marching to a different drummer than other people in the business," says Rodriguez. Theta-J's approach is to reduce the labor costs of solid-state-relay assembly by means of special package and circuit designs.

Most solid-state relays employ optoelectronic semiconductors for isolation. Instead, Theta-J uses pho-

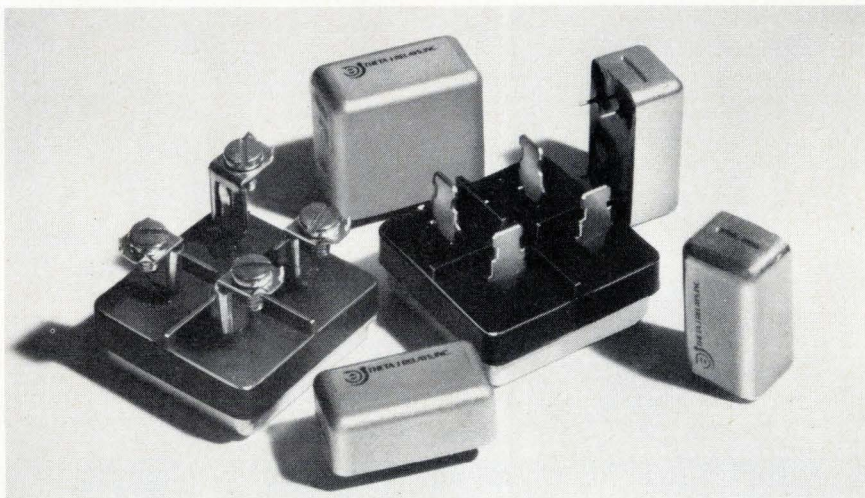

tocell optical coupling, which provides a minimum isolation of 1,500 v ac between input and output stages. Since the photocell is a bidirectional device, it needs no auxiliary circuitry as unidirectional light-emitting diodes and silicon photodetectors do, points out Rodriguez. Additionally, the proprietary photocell design is "far more sensitive" than semiconductor photocouplers, he claims.

And compared to conventional photocells, which require several milliseconds to switch, the Theta-J photocell responds in less than 1 ms, Rodriguez says. "We've made a turtle look like a rabbit in getting this faster switching," he observes.

In the dc models, the photocell provides inherent protection against switching spikes. All other solid-state dc relays are built with semiconductor optics, which switch in microseconds, says Rodriguez. That fast a switching speed can be a problem in dc relays because they are usually handling inductive loads, he points out. Large inductive spikes

can be generated, dictating the need for transient-protection circuitry. "With our photocell approach, however," says Rodriguez, "the rate of current change is so slow that the spike isn't generated, and we don't need that protective circuitry."

Special designs extend to the zero-crossover ac models, too. Like all zero-switching relays, these models do not turn on until the driving voltage sine wave is near its zero crossing.

The Theta-J patentable zero-switching technique, however, is a fundamental departure from existing methods because it makes use of a silicon controlled rectifier instead of a transistor, discloses Rodriguez. "We have a very lightly biased SCR that latches up and disables the entire control circuit at about the 10-v point in each half cycle," he explains. "This allows us to operate with microamps of current, compared to the substantial base-drive and collector currents required for a transistor. We just have to breathe

# Coming through...

with people, ideas, products—  
whatever it takes to get the job done



Wire, cable and cord sets usually cost less to buy than install. And poor performance can cut into your product's profitability deeper than potential savings on an initial buy. Belden is ready with whatever it takes to get the job done right.

**BROAD LINE:** Belden comes through with thousands of standards that fit your toughest environmental and application needs. And if a standard won't work, we will custom design an answer to your need.

**ENGINEERING HELP:** When you have problems in stripping, terminating, installing, fabricating, safety engineering, ordering, quality control, or want information on the codes or design parameters, ask a Belden specialist. "Hot-line" assistance is as near as 317-966-6681. Call and see.

**UNIQUE PUT-UP CAPABILITY:** Ask about Belden's UNREEL® dispensing system. Pays out wire continuously without snarls, backlash, or tensioning devices. One company cut processing time by 30%.\*

And Belden is coming through with a lot more. A design kit that covers performance characteristics, costs, material capabilities. And we've increased production capability for shorter lead times, great delivery.

Quality wire, cable and cord—whatever it takes to protect your bottom line performance every day. Belden Corporation, Electronic Division, P.O. Box 1327, Richmond, IN 47374, 317-966-6661.

8-6-6

\*Information available upon request.



Circle 121 on reader service card

**Coming through...**

*with new ideas for moving electrical energy*

Copyright © 1976 by Belden Corporation

Belden  
custom  
design kit

# Meet the "low cost" Bowmar TP-3120 Thermal Printer

Available off-the-shelf, the new Bowmar TP-3120 thermal printer does a lot more than many of the others for a lot less. With a speed of 1.07 lines per second, this quiet printer continues to maintain its economical advantage by using low-cost, high contrast, non-smear paper. Small in size and cost, yet big in capabilities, it's equipped with such Bowmar quality features as 12 position, dual read-out standard connector, right or left justification and 5x5 matrix design. Other highlights of the new Bowmar TP-3120 include:

- 18-Column Alpha/Numeric Printout
- 29.4 Characters Per Second
- Low Power Consumption
- MOS Compatible
- Immediate Delivery

So if you're looking for a better and less expensive way to meet your thermal print-out needs, just send us the completed coupon and we'll send you full and detailed information on Bowmar's new "low cost" TP-3120 thermal printer by return mail.



Please send me full information on Bowmar TP-3120 Thermal Printer.

Name \_\_\_\_\_

Company \_\_\_\_\_

Street \_\_\_\_\_

City \_\_\_\_\_

State \_\_\_\_\_ Zip \_\_\_\_\_

Mail to: Bowmar Instrument Corp.  
Dept. E, 8000 Bluffton Road  
Fort Wayne, IN 46809



## New products

on the SCR with nanoamps," he adds.

The new line has 18 categories of ac devices and 13 types of dc units. There are both standard and zero-switching ac types, and because the biggest part of the market is at the 10-A rating, Rodriguez homes in on the 10-A ac units as the relays that will probably be most popular.

The standard version, which is designated the TA-1210, has a load voltage range of 90-140 volts ac. Maximum control current at the nominal control voltage (5 v dc) is 15 mA. The zero-switching version of the same unit, the MA-1210Z, has the same output rating, but for a maximum control current of 7 mA. The MA-1210Z sells for less than \$4.50 each in quantities of 5,000.

Another ac unit that Theta-J expects to become popular as a solenoid or coil driver for high-power relays is the MA-1201, which is rated at 0.75 A. Its zero-switching counterpart is the MA-1201Z. Both of these devices have the same electrical characteristics as the 10-A units, except maximum control current is 7 mA for both. Prices are less than \$3 each in quantities of 5,000.

**Dc family.** The dc devices that Rodriguez expects to be big performers are 0.5-A and 5-A units. The TA-0605, with a maximum load voltage of 60 v, has a control current of 15 mA; the ultra-sensitive model TA-0605S has a maximum control current of 1 mA. The TA-0605 sells for less than \$8 each in lots of 5,000. There's also a 250-v version, the TA-2505.

The 0.5-A MA-06005, which is priced at \$3 each in 5,000-unit quantities, can handle 60 v dc maximum. Another 0.5-A unit, the TA-25005, operates at up to 250 v dc.

The devices (see photo on p. 120) with lower current ratings are housed in Theta-J's PowerDip package, which fits standard 16-pin DIP sockets or mounting holes; the high-current units are housed in a case the company calls J-PAK, which occupies less than 0.75 cubic inch.

Delivery time is four weeks.

Theta-J Relays Inc., 2 Linden St., Reading, Mass. 01867. Phone (617) 942-0390 [339]



# TOGGLE TERRITORY.

It's anywhere you are in the whole land.

It's anywhere you have to put your hands on exactly the right toggle switch to complete your design.

Especially if you need extraordinary design flexibility, distinctive appearance and proved performance in your toggle switches.

Cutler-Hammer not only provides the broadest line of toggle switches available, but offers you the greatest selection of ratings, terminations,

hardware, toggle shapes, materials and colors.

AC-rated. AC/DC. Low energy. Dry-circuit capability, or up to 25 amps. One, two and four poles. Select Cutler-Hammer Designer Line, miniature, slow-make/slow-break or hesitation switches from the complete Cutler-Hammer line. We have thousands of varieties ready for delivery. And if the toggle you need isn't among those thousands, we'll work with you to build exactly what you want.

You needn't look very far to get the finest quality in toggle switches. Wherever you are in the U.S.A., get the toggle you want. Because we cover Toggle Territory best. With

more distributors than anyone else. Call your Cutler-Hammer Sales Office or Stocking Distributor. Or write for full-line catalog LD-110A.



Switch  
to No.1

More than just switches;  
prompt availability,  
field help, innovation,  
quality assurance, too.



**CUTLER-HAMMER**  
SPECIALTY PRODUCTS DIVISION, Milwaukee, Wis. 53201

## New products

Components

### Transformer isolates 20 kV

Step-down unit holds leakage capacitance to mere 0.001 pF

The need for isolation in electronic equipment is a growing one, particularly in industrial and medical applications. Now there's an isolation power transformer from Stevens-Arnold that can satisfy the severe requirements of such applications as dc power transmission, mass spectrometers, X-ray equipment, and electron microscopes.

Originally designed to power the control circuitry for an 800,000-volt dc power-transmission line, the unit provides an input-to-output breakdown voltage of 20,000 v dc. Between its primary and secondary, leakage capacitance is only 0.001 picofarad in either the forward or reverse direction. This kind of performance, says Ezra F. Stevens, president, is achieved through the use of heavy multiple shielding, in conjunction with flux-cancellation techniques.

Rated at 15 watts, the transformer

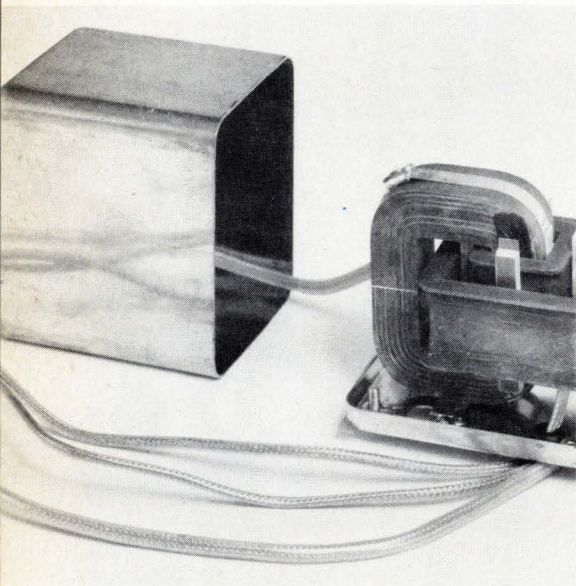

is a step-down unit whose primary winding can accept either 120 or 240 v ac. The secondary, which provides 8 v ac at 700 milliamperes, includes a center tap of 38 v ac at 250 mA. Common-mode rejection is 100 decibels.

Surprisingly, the transformer's case size is relatively small, measuring only 4.28 inches long by 3.66 in. wide by 4.06 in. high. The leads for both the primary and the secondary are shielded. They are 24 in. long for the primary and 12 in. long for the secondary. The case itself is made of steel and is finished in black.

For quantities of one to nine, each unit is priced at \$137.50. Delivery time is six weeks.

Stevens-Arnold Inc., 7 Elkins St., South Boston, Mass. 02127. Phone (617) 268-1170 [341]

Trimmer capacitor is quiet and reliable

Most rotating-piston adjustable capacitors use a central mechanism to control the motion of the piston within a glass sleeve. Thus any misalignment between the axis of the mechanism and the axis of the sleeve can cause jamming and breakage. Or, if the clearances are made large enough to avoid this, the result can be wobble and microphonic noise.

A new type of rotating-piston trimmer overcomes these problems by eliminating the central mechanism and using the glass sleeve both as a dielectric and as a mechanical guide. Key to the operation of the trimmer is high precision in the dimensions of the piston and sleeve. The clearance between the two is less than 0.5 mil.

Called the NB (for no-bushing) line, the trimmers have the additional advantage of being inexpensive because they use only three parts, compared with six or seven for conventional trimmers. The NB is offered in seven standard sizes: the smallest covers 0.8 to 4.5 picofarads, and the largest spans 1 to 36 pF. Working voltage is 750 v dc. The lower-value devices have a maxi-

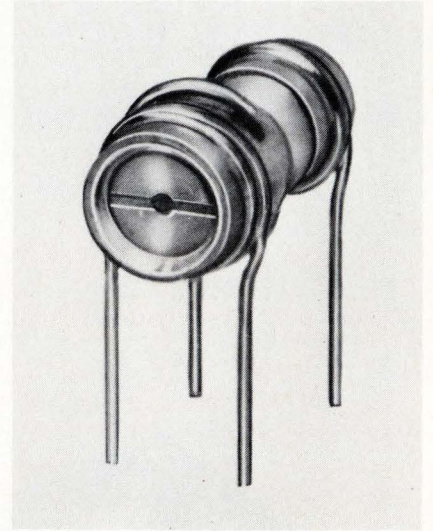

imum temperature coefficient of 100 ppm/°C while the larger can go as high as 150 ppm/°C. For quantities of 5,000, the prices range from \$1.05 to \$2.34 each.

Voltronics Corp., West St., East Hanover, N.J. 07936. Phone Richard J. Newman at (201) 887-1517 [343]

Line of compact DIP switches includes spdt and dpst units

A family of 15 DIP switches includes four single-pole, double-throw styles incorporating from two to five circuits per package, four double-pole, single-throw units incorporating four, six, eight, or 10 circuits per package, and seven spst switches with from four to 10 circuits per package. All 15 switches mount on standard 0.100-by-0.300-inch centers, making them suitable for automatic insertion into printed-circuit boards. The series 206 devices have a maximum initial contact resistance of 25 milliohms, which will increase to no more than 50 milliohms after 10,000 cycles of switching 50 milliamperes at 24 v dc. The switches have a maximum nonswitching rating of 100 mA at 50 v dc. Dielectric breakdown between adjacent switches is 500 v dc minimum, capacitance is 5 picofarads maximum, and insulation resistance between adjacent switches or across an open switch is 1 gighm minimum. Price

# VACTEC Photodetectors

The Industry's Broadest Line Provides More Semiconductor Detectors for More Design Applications

Vactec serves manufacturers of a wide range of modern electronic products. Pictured are a few examples. All these devices are both made and sold by Vactec, including complete lines of LDR's (photoconductive cells, CdS and CdSe); silicon solar cells, as well as silicon high speed and blue enhanced cells; NPN phototransistors and darlington's; opto-couplers (LED/LDR, lamp/LDR and neon/LDR); selenium photovoltaic cells; silicon photodiodes, blue enhanced and PIN; and custom C-MOS and bi-polar IC's. Write for technical bulletins on the types that suit your requirements. Or send your application, and Vactec will recommend the right cell for the job.

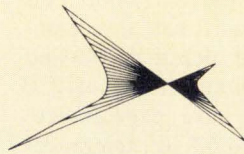

## Vactec, Inc.

2423 Northline Industrial Blvd.  
Maryland Heights, Mo. 63043  
(314) 872-8300

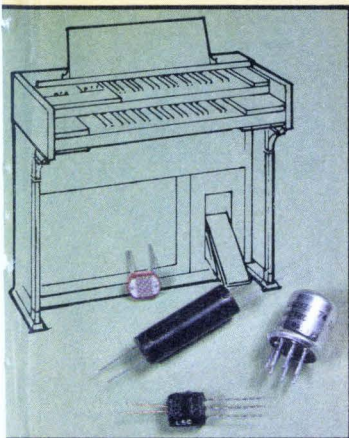

**Electronic Organs**

LED or lamp/LDR Vactrols for audio, and CdS cells for swell pedal controls.

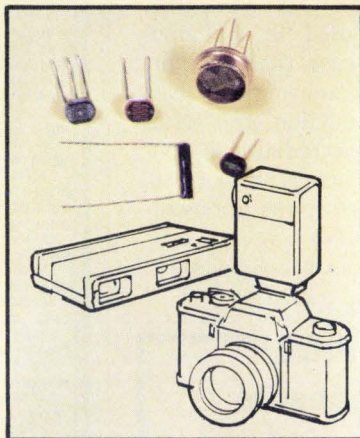

**Cameras and Projectors**

CdS or blue enhanced silicon photodiodes for automatic shutter timing; aperture servo systems for automatic projector focus; and slave flash controls.

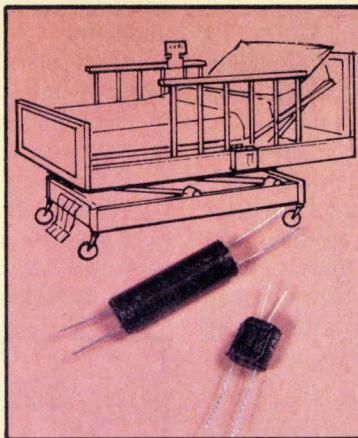

**Triac Motor Controls**

A special Vactrol gates a triac for forward and reverse motor operation as in hospital beds.

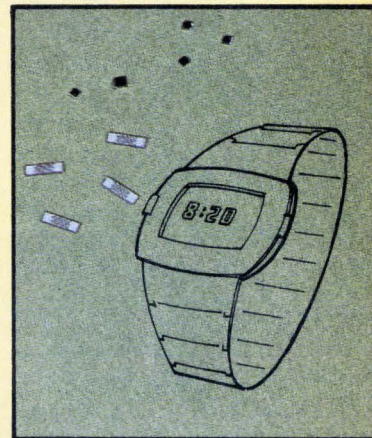

**LED Watches**

Photoconductive or phototransistor chip controls LED brightness.

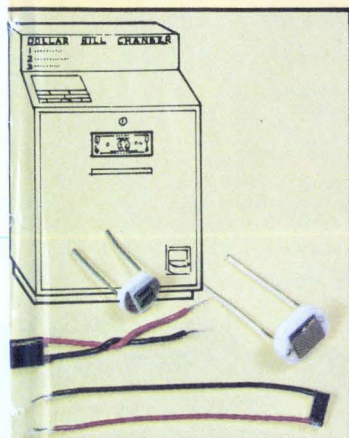

**Dollar Bill Changers**

Silicon photovoltaic cells analyze optical characteristics.

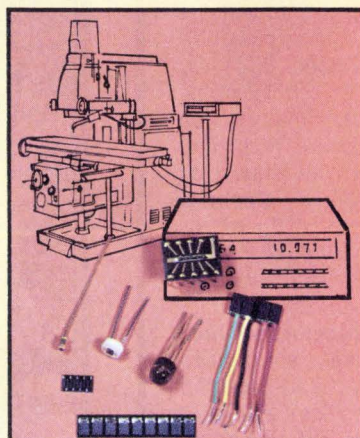

**Machine Tool Controls**

High-speed photovoltaic cells or transistor arrays help computer control repetitive operations, non-contact sensing, and counting and weighing.

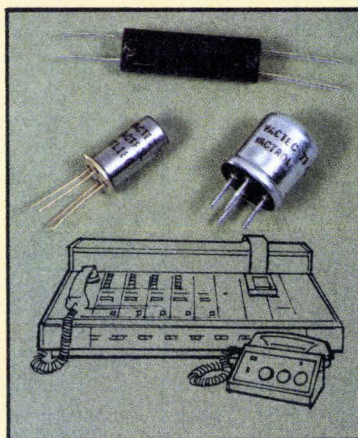

**Telephone Equipment**

Neon/LDR Vactrols sense ringing. Direct a-c coupling, slow LDR response isolates electronics from noise.

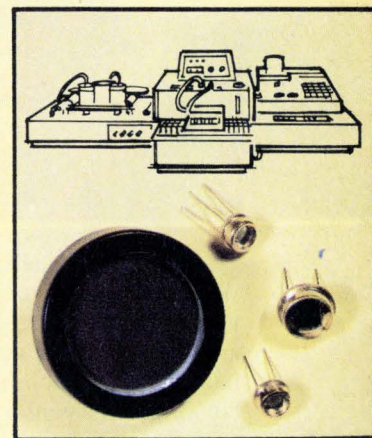

**Scientific Instruments**

Blue enhanced silicon or selenium photovoltaic cells detect solutions densitometrically for precise blood chemistry and other analyses.

## New products

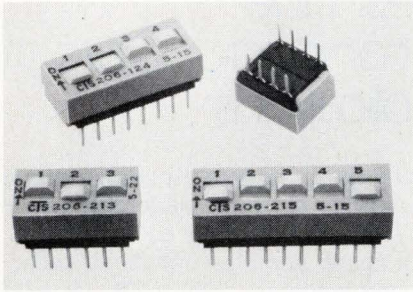

quotations and evaluation samples are available upon written request. Delivery time is six weeks.

CTS Keene Inc., 3230 Riverside Ave., Paso Robles, Calif. 93446. Phone (805) 238-0350 [345]

Stripswitch measures only 0.3 inch high

A low-profile line of Stripswitches measures only 0.3-inch high enabling it to be used on printed-circuit boards racked at 0.5-inch intervals. The switches can be mounted directly to pc boards by hand, wave, or flow soldering. Single modules can be snapped together to form a multi-switch assembly of any desired length. This feature allows the mixing of different codes within a single assembly.

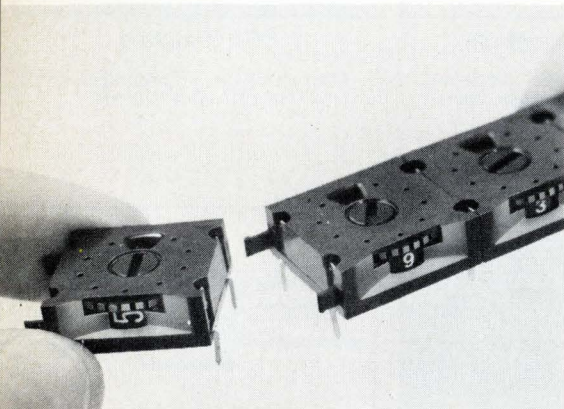

Available models offer thumb-wheel or screwdriver setting with the legend located on top or side. Stops are provided, if necessary. Codes include 10-position binary-coded decimal, complementary BCD, plus and minus signs, and decimal. Prices start below \$2 each for 1,000-piece

lots of BCD switches. Delivery time is four weeks.

EECO, 1441 East Chestnut Ave., Santa Ana, Calif. 92701. Phone "Switch Products" at (714) 835-6000 [346]

Polycarbonate capacitors sell for only 6.5 cents

A line of metalized polycarbonate capacitors, the series CMK, includes models that sell for as little as 6.5 cents each in lots of 5,000. This least-expensive unit has a capacitance of 0.01 microfarad  $\pm 20\%$  and a dc working voltage rating of 250 V. Other units have capacitances from 0.0027  $\mu\text{F}$  to 6.8  $\mu\text{F}$ , tolerances of 20%, 10%, 5%, and 2.5%, and working voltages of 100 v, 250 v, and 400 v. Housed in a flame-resistant plastic case that is unaffected by any solvent commonly used in electronic production, the series CMK devices have radial-lead construction. Lead spacings are 0.4, 0.6, 0.9, and 1.1 inches. Units are available from stock.

Seacor Inc., 598 Broadway, Norwood, N.J. 07648. Phone (201) 768-6070 [344]

## TOPICS

### Components

**Dale Electronics Inc., Columbus, Neb.**, which claims close to 50% of the precision power wire-wound resistor market, has raised prices on its wire-wound resistors by 5% to 10%. . . **C&K Components Inc., Watertown, Mass.**, has introduced a momentary-contact subminiature push-button switch, the model 8531. By specifying the "C" terminals, the user gets a switch that can be mounted on pc board. Free samples are offered on request to qualified specifiers. . . **Spectrol Electronics Corp., City of Industry, Calif.**, has added a bushing-mount option to its popular model 43 multi-turn cermet trimmer line. . . **Russelectric Inc., Hingham, Mass.**, announces that its line of load-breaking isolating switches has been listed by Underwriters' Laboratories.



# Zilog products are available now. Contact:

**ALABAMA HUNTSVILLE**  
Technology Marketing Assoc. (205) 883-7893

**ARIZONA MESA**  
Nakoma (602) 834-6549

**CALIFORNIA NEWPORT BEACH**  
Nitrox (714) 545-4272

**CALIFORNIA MOUNTAIN VIEW**  
The Thorson Company (415) 964-9300

**CALIFORNIA SAN DIEGO**  
Littlefield & Smith Assoc. (714) 277-8044

**COLORADO BOULDER**  
RG Enterprises, Inc. (303) 447-9211

**DELAWARE**  
Quay Corporation (201) 462-9606

**FLORIDA ORLANDO**  
Technology Marketing Assoc. (305) 857-3760

**FLORIDA ORMAND BEACH**  
Technology Marketing Assoc. (904) 672-2314

**FLORIDA POMPANO BEACH**  
Technology Marketing Assoc. (305) 942-0774

**ILLINOIS SKOKIE**  
Mar-Con Associates, Inc. (312) 675-6450

**INDIANA INDIANAPOLIS**  
S.A.I. Marketing Corp. (317) 297-3146

**MASSACHUSETTS WALTHAM**  
Impact Sales (617) 893-2850

**MICHIGAN BRIGHTON**  
S.A.I. Marketing Corp. (313) 227-1786

**MICHIGAN GRAND RAPIDS**  
S.A.I. Marketing Corp. (616) 942-2504

**MINNESOTA MINNEAPOLIS**  
Quantum Sales, Inc. (612) 831-8583

**MISSOURI FLORISSANT**  
S.A.I. Marketing Corp. (313) 837-5200

**NEW JERSEY FREEHOLD**  
Quay Corporation (201) 462-9606

**NEW YORK ITHACA**  
Dean, Bob, Inc. (607) 272-2187

**NEW YORK LONG ISLAND**  
Quay Corporation (201) 462-9606

**NEW YORK NEW YORK CITY**  
Quay Corporation (201) 462-9606

**NORTH CAROLINA RALEIGH**  
Dean, Bob, Inc. (919) 851-2065

**OHIO BEACHWOOD**  
S.A.I. Marketing Corp. (216) 292-2982

**OHIO CINCINNATI**  
S.A.I. Marketing Corp. (513) 761-5432

**OHIO DAYTON**  
S.A.I. Marketing Corp. (513) 277-8911

**OHIO READING**  
S.A.I. Marketing Corp. (513) 761-5432

**PENNSYLVANIA PHILADELPHIA**  
Quay Corporation (201) 462-9606

**PENNSYLVANIA PITTSBURGH**  
S.A.I. Marketing Corp. (412) 782-5120

**TEXAS DALLAS**  
The Thorson Company (214) 233-5744

**TEXAS HOUSTON**  
The Thorson Company (713) 771-3504

**VIRGINIA ALEXANDRIA**  
Dyna Rep Company (703) 354-1222

**WASHINGTON BELLEVUE**  
SDR<sup>2</sup> Products & Sales (206) 747-9424

**CANADA**

**CALGARY, ALBERTA**  
Westronic Engineering (403) 253-5585

**OTTAWA, ONTARIO**  
Datagraphics (613) 225-0411

**TORONTO, ONTARIO**  
Datagraphics (416) 622-6752

**DENMARK**  
SC Metric A/S 01/80 42 00

**FINLAND**  
FINN Metric OY 0/46 08 44

**FRANCE BOULOGNE**  
AZW 603-66-40

**GERMANY MUNCHEN**  
Kontron Elektronik GMBH (08165) 7 71

**ITALY MILAN**  
Ezimar SPA 2-3493-041

**NETHERLANDS AMSTERDAM**  
Telelec-Airtronic 020-92 87 66

**NORWAY**  
Metric A.S. 02/28 26 24

**SWEDEN SOLNA**  
Scandia Metric AB 08/82 04 00

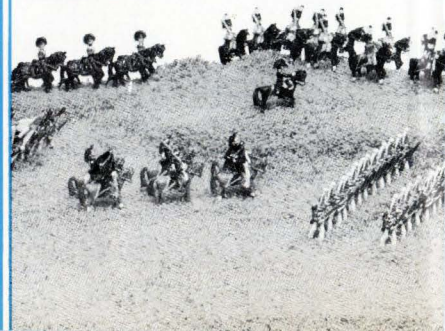



# The Battle of the 80's continues:

The Z-80 is a third generation LSI component set including CPU and I/O Controllers with full software support and second sourcing available now.

**A single chip, N-channel processor** arms you with a super-set of 158 instructions that include all of the 8080A's 78 instructions with total software compatibility. The new instructions include 1, 4, 8 and 16-bit operations. That means less programming time, less program storage and less end costs. And you get memory-to-memory or memory-to-I/O

block transfers, nine types of rotates and shifts, bit manipulation, a legion of addressing modes and a standard instruction speed of 1.6 $\mu$ sec. The Z-80 CPU and peripheral circuits require only a single 5V power supply and a single phase clock. With these circuits you can interface directly to a wide range of both parallel and serial interface peripherals and even dynamic memories without other external logic. With all these features you'll require approximately 50% less memory space for program storage and you'll get up to 500% more throughput than the 8080A.

**The Zilog Battalion includes a development system with:** Z-80 CPU Card with 4K Bytes of ROM/RAM Monitor software • 16K Bytes of RAM memory, expandable to 60K Bytes • Real Time Debug Module and In-Circuit Emulation

With the introduction of Zilog's Z-80 microcomputer products the tide is turning in the battle for supremacy.

Features:	8080A	Z80-CPU	Features:	8080A	Z80-CPU
Power Supplies	+5, -5, +12	+5	Addressing Modes	7	11
Clock	2 $\Phi$ , +12 Volt	1 $\Phi$ , 5 Volt	Working Registers	8	17
Standard Clock Speed	500 ns	DC to 400 ns	Static Operation	No	Yes
Interface	Requires 8222, 8228 & 8224	Requires no other logic and includes dynamic RAM Refresh	Non-maskable Interrupt	No	Yes
Interrupt	1 mode	3 modes; up to 6X faster	Full TTL Compatibility	No	Yes
Instructions	78	158*	Throughput	Up to 5 times greater than the 8080A	
OP Codes	244	696	Program Memory	Generally 50% less than the 8080A	
			*Including all of the 8080A's instructions.		

Module • Dual Floppy Disc System • Software Package including Z-80 Assembler, Editor, Disc Operating System, File Maintenance and Debug.

We'll support this with resident microcomputer software, time sharing programs, software libraries and high-level languages such as PL/Z.

**A reserve of reinforcements is ready.** The Zilog Z-80 brings to the battlefield new levels of performance and ease of programming not available in second generation systems.

And while all the others busy themselves with overtaking the Z-80, we're busy on the next generation—continuing to demonstrate our pledge to stay a generation ahead.

The Z-80's troops are the specialists who were directly responsible for the development of the most successful first and second generation microprocessors. Nowhere in the field is there a corps of seasoned veterans with such a distinguished record of victory.

**Think of your next microcomputer as a weapon against horrendous inefficiencies, outrageous costs and antiquated speeds.**



**Zilog** MICROCOMPUTERS

170 State Street, Los Altos, California 94022  
(415) 941-5055/TWX 910-370-7955

AN AFFILIATE OF **EXON** ENTERPRISES INC.

Circle 127 on reader service card



# No. Galileo is not the little old Napa Valley winemaker.

Galileo Electro-Optics Corp. isn't little nor relatively old. And no, we don't make wine either. Galileo is simply one of the world's largest producers of optical communication cable.

Our new Galite™ family consists of five completely different types of optical communication cable. Because the Galite family is the widest range of cables available anywhere, we can thus service your particular needs best.

All Galite cables are immune to electromagnetic interference (EMI/RFI), are much lighter than coaxial cable, eliminate cross talk between channels and have a higher information carrying capacity than conventional cable. And all are available right now from current stock.

Galite 3000 is a truly new and unique optical communication cable. And because of our exclusive



rights to a patented glassmaking process, Galileo is its only source in North America. These fibers are constructed of high purity glass to reduce attenuation. The cladding glass, deposited by this patented process, is impervious to organic solvents and retains its unique properties at temperatures where plastic fibers deteriorate.

Galite 3000 is a step index optical fiber for transmitting data primarily from 70 to 330 meters/230 to 1100 ft. This range accommodates most current market applications such as link-

ing computer terminals, shipboard and aircraft communication and control systems, and automated process controls.

For more information, write: Galileo Electro-Optics Corporation, Galileo Park, Sturbridge, Mass. 01518. Or call us at (617) 347-9191.

*Imagine what we could be doing for you right now.*

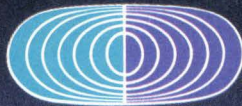

**Galileo Electro-Optics Corp.** Galileo Park, Sturbridge, Massachusetts 01518, (617) 347-9191

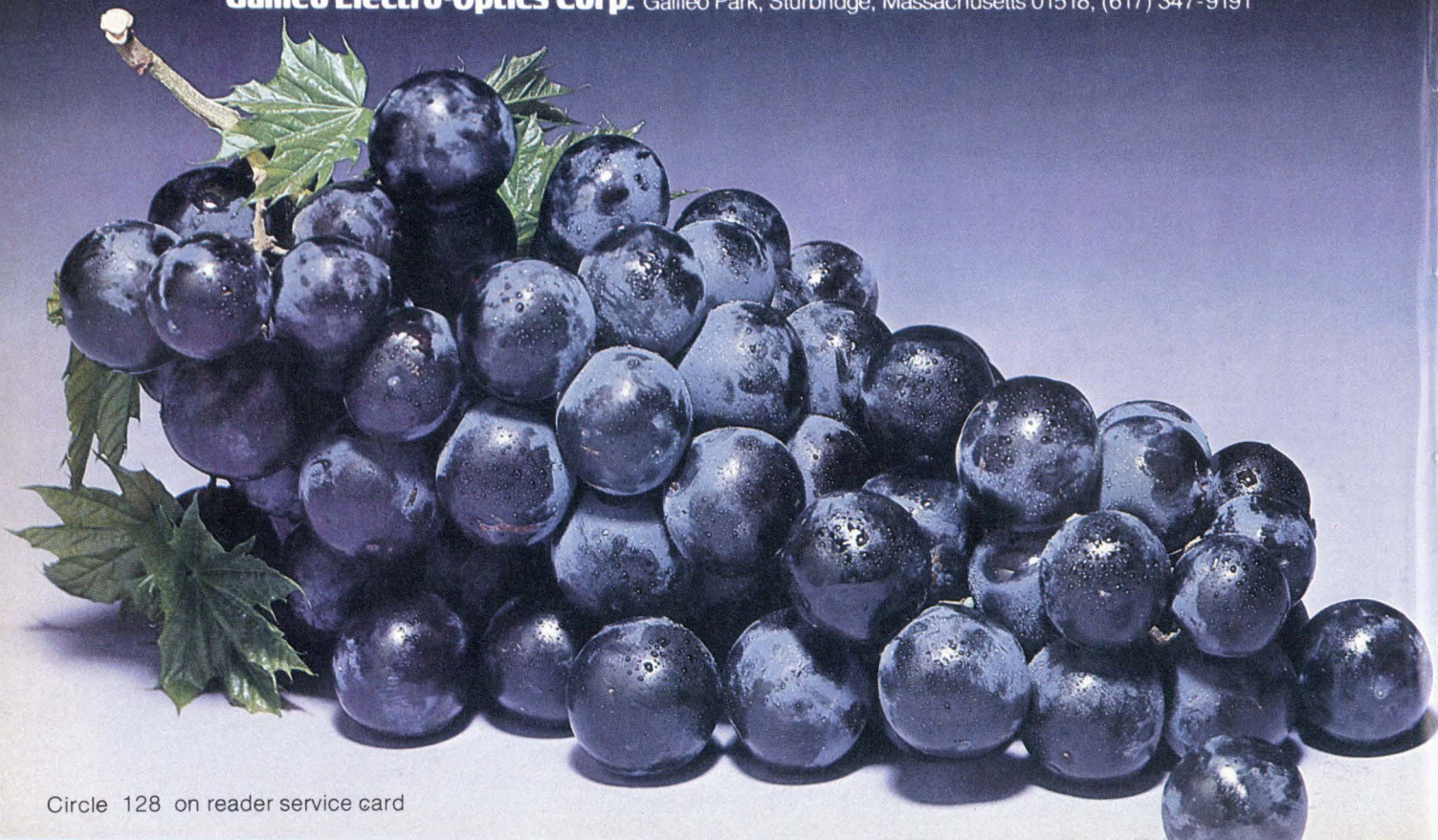

## New products

Packaging & production

### Chip inspection is simplified

Operator keeps specimen under view during both test and pickup steps

A company that specializes in supplying semiconductor chips to hybrid-circuit manufacturers gains considerable experience in visual inspection of the chips. Semiconductor Services Inc., Salem, Mass., is such a company, and has found that visual inspection can be a slow and tedious process, often leading to error as operators reject good dice and let bad ones get by. To combat the problem, SSI has developed its own inspection station, the SSI-1000, which allows the operator to inspect and pick up rejects while maintaining a continuous view through the microscope.

James E. Hearl, SSI president, says that conventional microscope-inspection stations require the operator to view the chip through the binocular eyepiece, then take her gaze away from the microscope to remove a bad die—using a vacuum needle and unassisted vision. The

frequent change from viewing through the microscope to viewing with the naked eye is slow, causes fatigue, and can result in the wrong die being removed from the carrier.

The SSI-1000 allows the operator to maintain her view through the microscope for both the inspection and pickup steps. An inverted-joystick control at the left is rotated around its own axis with the left hand to position the chip carrier under the field of view. A simple circular motion of the knob on the end of the joystick allows viewing of the entire chip, and, if it passes inspection, the operator rotates the joystick again with the left hand, indexing the stage holding the chip carrier from right to left and bringing the next chip into view.

If a chip is to be rejected, the operator uses her right hand to activate the vacuum pickup. The pickup arm uses vacuum force through a floating transfer tip, which moves through a combined arc and vertical motion, picking up the chip under inspection and automatically depositing it in a reservoir. At the end of a row of chips in the carrier, the operator manually indexes to the next row, still under microscope view.

The SSI-1000 is designed for both production and quality-control inspection, accommodates standard Fluorwave chip carriers, and handles chips ranging from 15 to 500 mils on a side.

The complete station, including the Nikon 100× to 150× magnification microscope, sells for \$1,795; the inspection platform with controls, for users who have their own microscope, is priced at \$695. Delivery time is four weeks.

Semiconductor Services Inc., 1 Peabody St., Salem, Mass. 01970. Phone (617) 745-2450 [391]

Connectors designed for hazardous environments

Because they have no pins and jacks, inductive electrical connectors made by Pelcon Ltd. have no metal-to-

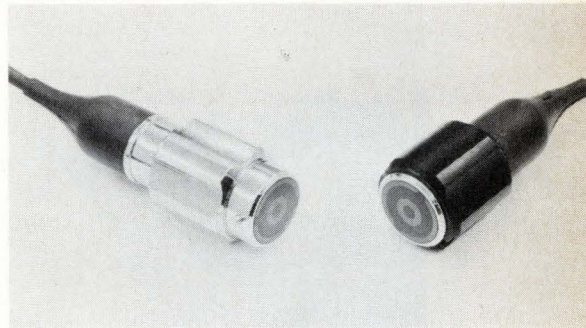

metal contacts to short, arc, or deteriorate. The connectors can be mated in an explosive, deep-water, or other difficult or hazardous environment under load conditions. These connectors can handle analog signals, fm multiplexed signals, sensor information and fast-rise-time digital pulses. Coupling efficiency between the connector faces is said to be 95 to 99%, and the units can handle a wide range of power ratings.

Pelcon Ltd., P.O. Box 8143, Station A, St. John's, Newfoundland A1B 3M9, Canada [393]

Software package generates program for board tests

In-circuit inspection programs for digital-logic printed-circuit boards are automatically generated by a software package built by Zehntel and called D-PACT. Key to the automatic generation of software is the Isodrive digital inspection system that tests each logic element (such as gate, flip-flop, counter, and shift register), isolating it from the influences of neighboring digital and analog components. Using a bed-of-nails fixture and a low-impedance, fast-pulse-drive technique, Isodrive performs a functional truth-table examination directly at the input and output pins of each logic device on the assembly.

Because each element is treated independently, standardized test routines may be used for each type of logic function.

D-PACT software will be available for general use on Mark III Timeshare network software services

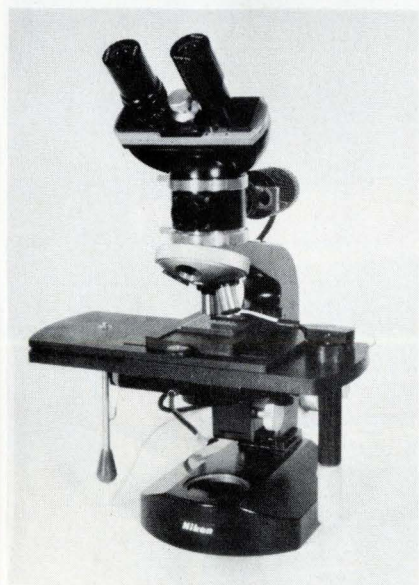

## New products

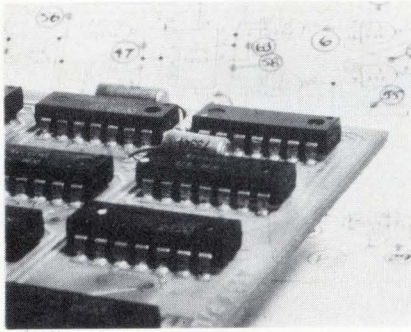

offered by the General Electric Co. Program-generation costs are estimated at about \$2 per integrated circuit chip.

D-PACT software is also available for Zehntel's Troubleshooter 400 system, allowing program generation on the tester itself. D-PACT may be retrofitted to the 400 system for a price of \$1,500.

Zehntel Inc., 2440 Stanwell Dr., Concord, Calif. 94520. Phone Craig Pynn at (415) 676-4200 [394]

## Benchtop system checks out multilead devices

A fully automated, user-programmable, bench-top system for high-volume testing of multilead devices, called the GR 2230, uses a powerful microcomputer, the Digital Equipment Corp. LSI-11. The 2230 evaluates, tests, and provides hard-copy data for both discrete and hybrid networks. Its versatility permits rapid mixed measurements on circuits containing resistors, capacitors, inductors, and diodes or transistors.

Networks can be tested from one point to any other point with built-in scanners under program control. Selective guarding via the scanner matrix can minimize the effects of stray impedance or isolate circuit elements between "buried nodes" on the unit under test.



In addition to testing single in-line and dual in-line-package networks, the 2230 can test functional modules such as voltage regulators and digital-to-analog converters. Device adapters for individual interfacing needs with ample space and electrical provisions for accommodating any required special circuitry add to the flexibility of the system. Prices start at \$14,500.

GenRad Inc., 300 Baker Ave., Concord, Mass. 01742. Phone (617) 369-4400 [395]

these two Panel Meters...  
can become 93 different measuring instruments...

# count'em.

DC and AC Volts .....	23 models
DC and AC Current .....	20 models
DC Autoranging .....	2 models
True rms .....	8 models
Thermocouple C or F .....	16 models
RTD C or F .....	4 models
Thermistor C or F .....	8 models
Offset and Scaled .....	4 models
Process Monitors .....	8 models

## and the best part is...

You can change to any one of these models anytime. It is as simple as reprogramming the rear connector or adding one of DigiTec's exclusive adapters. Call or write for complete specifications.

These instruments are available under GSA Contract, GS-00S-27741.

*DigiTec: Precision Measurements to count on*

**DigiTec.** UNITED SYSTEMS CORPORATION

918 Woodley Road, Dayton, Ohio 45403  
(513) 254-6251, TWX (810) 459-1728



# Trigac VI digital-to-synchro converter gives you accuracy and power without raising your temperature.

The closest thing yet to a Solid State Synchro, Kearfott's Trigac VI Modular Digital-to-Synchro/Resolver Converters provide the accuracy and power you need, with a bonus. In addition to standard 4 arc minutes of accuracy at 1 volt ampere, the transformation ratio remains constant within  $\pm .25\%$ . We also have units constant within  $\pm 0.1\%$ . That can make the difference between delivering power or just throwing it away.

Let us help you be cost effective. Standard options range from industrial grades thru hi-reliability units, from accuracies of  $\pm 20$  arc minutes to  $\pm 1$  arc minute and, in addition, special designs and packaging as you require.

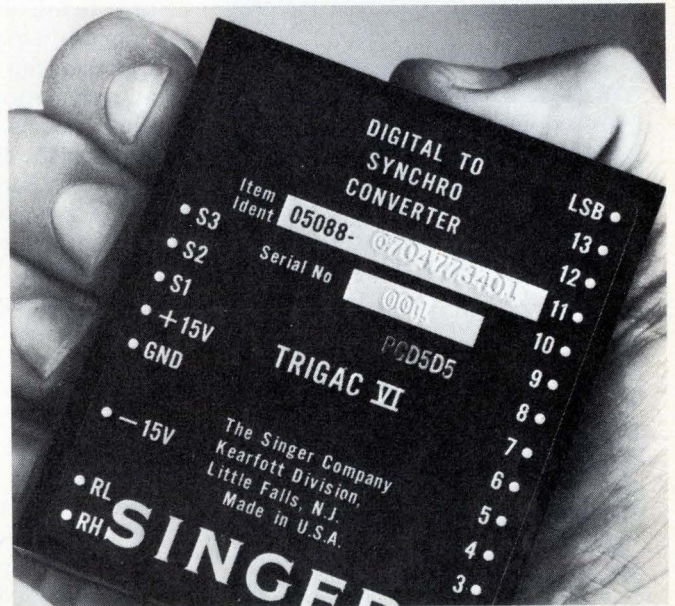

## Need more power? Try our line of compatible synchro amplifiers.

Our 3185 Series is designed to perform the synchro power buffering or resolver to synchro (Scott-T) function. They provide matched power amplifier channels and transformer coupled outputs capable of driving torque repeaters or multiple control transformers up to 5 va. These fully potted units feature overload protection, low-quiescent currents and transformer-isolated outputs. Models available range from industrial to full MIL-SPEC high-reliability grades.

**NEED ADDITIONAL POWER?** We have units available with power outputs to 50 va, 60 or 400 Hz operation, and options of built in digital converters and/or power supplies.

For details on our converters and amplifiers, contact The Singer Company, Kearfott Division, 1150 McBride Avenue, Little Falls, New Jersey 07424.

**SINGER**  
AEROSPACE & MARINE SYSTEMS

# THE DETECTORS

Tough infrared measurement problems are no match for The Detectors . . . Sensors' rugged, reliable, low cost thermopile detectors.

Whatever your application . . . from temperature monitoring, spectrophotometry or pollution monitoring to intrusion and fire detection, horizon sensing instrumentation or laser power measurement, The Detectors are ready to help you solve it.

One of The Detectors has the precise combination of high  $D^*$ , convenient resistance range, excellent responsivity, fast time constant and broad spectral response for your specific application.

Learn about the entire Sensors' line of thin film thermopile detectors. Ask for the free brochure now.

 **sensors, inc.**  
3908 VARSITY DRIVE  
ANN ARBOR, MI 48104  
TEL: (313) 973 - 1400

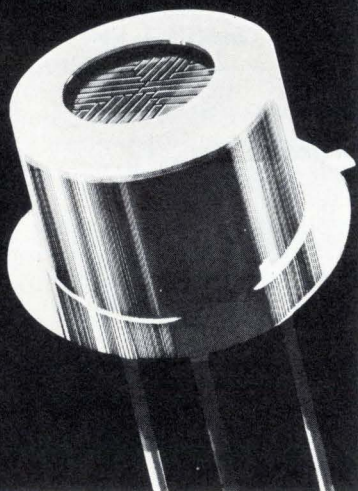

## New products

Semiconductors

### Optical gate cuts parts count

High common-mode rejection  
of photocoupler simplifies  
design of high-speed circuits

High-speed optically coupled gates are being increasingly used as isolated line receivers and as interface elements in computer peripheral, microprocessor, and data-conversion systems. However, their high gain makes many of them susceptible to drowning in a sea of common-mode noise.

Eliminating common-mode interference is a major task in system design, and engineers have traditionally solved the problem by such methods as using twisted-pair lines, a shield, good printed-circuit-board layout, trick circuits, and surrounding the optically coupled gates with NAND or NOR flip-flops.

Now, however, Hewlett-Packard's Optoelectronics division is introducing a high-speed optically coupled gate, the 5082-4361, with a common-mode rejection 10 to 100 times higher than present devices. That capability allows designers to reduce component count in their systems by at least two thirds, HP says. In addition, says Gary Labelle, optoisolator marketing engineer, the 5082-4361 is priced only 30% to 40% higher than competing devices.

Like an earlier HP high-speed optical gate, the 5082-4360, the new

device combines a gallium-arsenide-phosphide light-emitting diode and an integrated high-gain photodetector. It has a 5-milliamperere input current and a compatible supply.

But, unlike previous devices, the 5082-4361 provides a minimum guaranteed common-mode transient-immunity specification of 1,000 volts per microsecond, equivalent to rejecting a 300-v peak-to-peak sinusoid at 1 megahertz. Typical figures are more like 10,000  $v/\mu s$ , compared to typical values ranging from 50 to 150  $v/\mu s$  for other devices.

And compared with typical propagation delays of about 45 nanoseconds and output fall times of about 25 ns on earlier devices, the 5082-4361 has a typical propagation delay of 35 ns and an output fall time of 15 ns. The high common-mode rejection is achieved, says Labelle, by using an optically transparent, electrically conductive shield on the detector portion of the device. "The shield," he says, "shunts capacitively coupled input/output currents to ground so that the photodetector does not respond to them."

The shield, a continuous deposited film, covers all sensitive areas of the detector circuit (as shown in the white part of the photomicrograph). "This technique is more effective in improving common-mode rejection than other approaches, which rely on grounding photocathode p regions," says Labelle, "because a much higher conductivity can be obtained, and amplifier circuitry can be protected, as well. The resulting photocathode structure also has much less capacitance, and, therefore, higher operating speeds can be achieved."

The 5082-4361 is also suitable, says Labelle, for high-speed logic interfacing, I/O buffering, and as a line receiver in environments that conventional line receivers cannot tolerate. It is also recommended for use in extremely high-ground or noise-induced environments.

Maximum ratings include an operating temperature of 0°C to 70°C, a forward input current of 20 milliamperes, a reverse input voltage of 5 v, a supply voltage of 7 v, an enable voltage of 5.5 v, an output

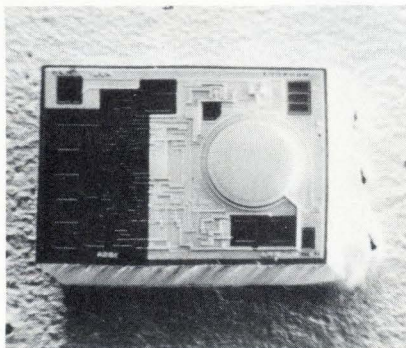

collector current of 25 mA, an output-collector power dissipation of 40 milliwatts, and an output-collector voltage of 7 v. Available now, the devices are priced at \$6.20 each in quantities of 1,000.

Hewlett-Packard Co., Optoelectronics Division, 640 Page Mill Rd., Palo Alto, Calif. 94304 [411]

IC has all control circuitry for switching power supply

The SG1524 is an inexpensive linear integrated circuit that contains all the control circuitry needed for a regulating power-supply inverter or a switching power supply. Included

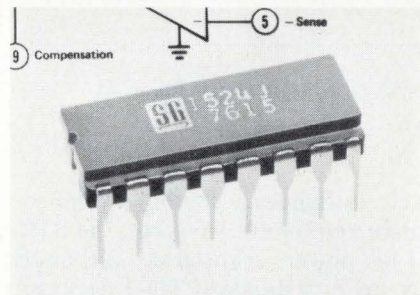

in the 16-pin dual in-line package is a voltage reference, an error amplifier, a constant-frequency oscillator, a pulse-width modulator, a pulse-steering flip-flop, dual alternating output switches, and current-limiting and shut-down circuitry. Designed to replace 20 discrete components, the SG1524 almost reduces the design of switching power supplies to the selection of power semiconductors and the magnetic circuitry. Supplied in a hermetic ceramic DIP, the IC sells for \$15.50 in quantities of 100.

Silicon General Inc., 7382 Bolsa Ave., Westminster, Calif. 92683. Phone E. Bentgen at (714) 892-5531 [413]

12-bit multiplying d-a converter sells for \$8

Although it has only 8-bit linearity, the AD7531 multiplying digital-to-analog converter has 12-bit resolu-

# Schottky Barrier Rectifiers

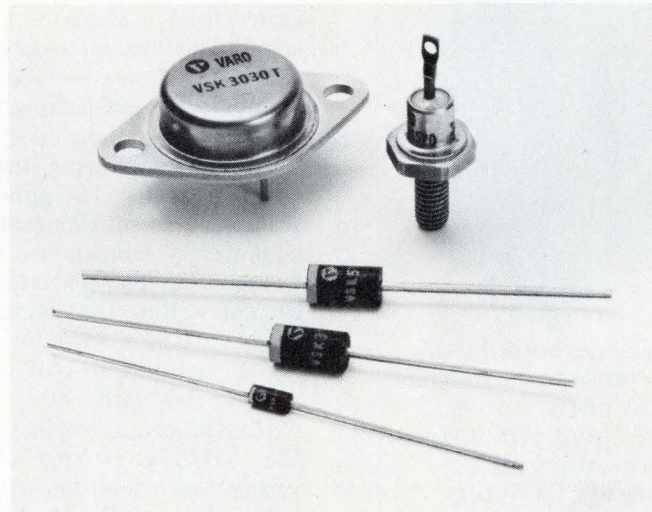

- **Five series: 1A, 3A, 5A, 15A & 30A ( $I_o$ ) with 20V, 30V and 40V ( $V_{RRM}$ ).**
  - **Extremely fast recovery ( $t_{rr}$ ), very low forward voltages ( $V_f$ ), high reliability and low cost.**
  - VSK 120, 130 & 140-1A series in DO-41 packages. 550 mV ( $V_f$ ). 40A peak  $\frac{1}{2}$  cycle surge ( $I_{FSM}$ ). 10 mA ( $I_R$ ) at  $T_L = 100^\circ\text{C}$ .
  - VSK 320, 330 & 340-3A series. Epoxy package, axial leads. 475 mV ( $V_f$ ). 150A surge. 30 mA ( $I_R$ ) at  $T_L = 100^\circ\text{C}$ .
  - VSK 520, 530 & 540-5A series. Epoxy package, axial leads. 450 mV ( $V_f$ ). 250A surge. 75 mA ( $I_R$ ) at  $T_L = 100^\circ\text{C}$ .
  - VSK 1520, 1530 & 1540-15A series in DO-4 metal stud cases. 600 mV ( $V_f$ ). 300A surge. 75 mA ( $I_R$ ) at  $T_c = 100^\circ\text{C}$ .
  - VSK 3020T, 3030T & 3040T-30A series. Center-tapped, common cathode, 15A per leg in TO-3 package. 630 mV ( $V_f$ ). 300A surge. 75 mA ( $I_R$ ) at  $T_c = 100^\circ\text{C}$ .
- All series have junction operating temperature range of  $-65^\circ\text{C}$  to  $+150^\circ\text{C}$ .

Call Mike Hawkins  
214/272-4551  
for more information



Design us in . . . we'll stay there  
**VARO SEMICONDUCTOR, INC.**

P.O. BOX 676, 1000 N. SHILOH, GARLAND, TEX. 75040  
(214) 272-4551 TWX 910-860-5178

EUROPEAN OFFICE: UK: VARO SEMICONDUCTOR INTERNATIONAL, INC.  
Deepdene House, Bellegrave Road, Welling, Kent, England DA163PY, 01-304-6519/0

A great place  
to start  
expanding  
your  
company  
is right here.



Our 16 page book talks about the labor force, about deep water ports, about utilities, temperatures, taxes. There's everything here from financing to flying times, from industries to schools—all the things that make Northwest Florida one of the most profitable, most livable business climates in the country. And it's free.

Gulf Power Company  
Manager, Area Development  
Department D-8  
P. O. Box 1151  
Pensacola, Florida 32520  
Please send me your book.

Name \_\_\_\_\_

Title \_\_\_\_\_

Company \_\_\_\_\_

Address \_\_\_\_\_

City \_\_\_\_\_

State \_\_\_\_\_

Zip \_\_\_\_\_

## New products

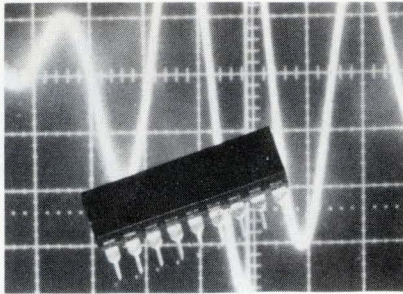

tion and a 100-piece price of only \$8. The monolithic C-MOS device operates from a single 5- to 15-v dc supply and dissipates only 20 milliwatts. The low power consumption assures little self-heating, and thus contributes to the unit's low drift: maximum gain-error temperature coefficient is 10 ppm of full scale/°C, and maximum differential nonlinearity temperature coefficient is 2 ppm/°C. The converter's output-current settling time is 500 nanoseconds to 0.05% when switching all digital inputs from LOW to HIGH or HIGH to LOW with a 10-v reference.

Housed in an 18-pin plastic DIP, the AD7531 is also offered in versions with 9-bit linearity (\$10.50 each in hundreds) and 10-bit linearity (\$23.50). Ceramic DIPs are also available at extra cost. All versions are available from stock.

Analog Devices Inc., P.O. Box 280, Norwood, Mass. 02062. Phone Lowell Wickersham at (617) 329-4700 [416]

## C<sup>2</sup>R construction yields fast high-gain power transistors

Built using charge-control-ring (C<sup>2</sup>R) construction, a series of npn power transistors combine high gain and

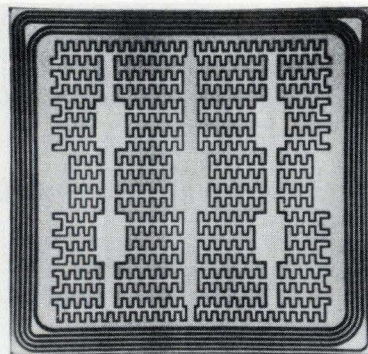

high speed with voltage ratings up to 400 v and continuous current ratings up to 20 amperes. Minimum  $h_{FE}$  is 10 for the 400-v units, rising to 20 for the 300-v devices. With a supply voltage of 100 v and a collector current of 15 A, the transistors have a maximum turn-on time of 0.07 microsecond, a maximum storage time of 0.35  $\mu$ s, and a maximum turn-off time of 0.2  $\mu$ s. Other models, with collector-current ratings below 20 A, have similar specifications, but are somewhat faster. Prices, in hundreds, range from \$13 each for a 15-A, 300-v unit, up to \$20 for the 20-A, 400-v device. Delivery time is four weeks.

General Semiconductor Industries Inc., 2001 West Tenth Pl., Tempe, Ariz. 8521. Phone Betty Trenberth at (602) 968-3101 [417]

## 100-ampere transistor in TO-3 can has 500-W rating

Able to handle a continuous collector current of 100 amperes, the STC 9142 power transistor, although housed in a standard TO-3 package, has a power dissipation rating of 500 watts. At full current, the device has a minimum  $h_{FE}$  of 10, and turn-on and turn-off times of 2 and 5 microseconds, respectively. The transistor is intended to replace parallel arrangements of lower-power devices in series-pass regulators and in dc to medium-frequency amplifiers. It sells for \$41.25 each in small quantities, dropping to \$30 each in hundreds.

Silicon Transistor Corp., Katrina Rd., Chelmsford, Mass. 01824. Phone William A. Schromm at (617) 256-3321 [415]

## 4,096-bit RAM has 150-ns access time

Believed to be the industry's fastest 4,096-bit random-access memory housed in a 16-pin DIP, the MK 4027-2 has an access time of 150 nanoseconds and TTL-compatible inputs. The memory features a  $\pm 10\%$  tolerance on all power-supply vol-





tages as a standard feature.

In addition to the usual read, write, and read-modify-write cycles, the MK 4027-2 is capable of page-mode timing and row-address-select-only refresh cycles. Page-mode operation reduces the access time to 100 ns with no increase in power consumption. RAS-only refresh is a simplified refresh operation that cuts power consumption.

The output of the memory will supply 5 milliamperes or sink 3.2 mA. In addition, it can work into capacitances as high as 100 picofarads. In 100-piece lots, the device sells for \$24.20 each.

Mostek Corp., 1215 W. Crosby Rd., Carrollton, Texas 75006. Phone (214) 242-0444 [418]

Power rectifier has  
recovery time of 35 ns

A fast, high-efficiency power rectifier, the 1N5812, is believed to be the only such device on the market that combines ratings of 200 volts and 20 amperes with a reverse recovery time of only 35 nanoseconds. Other models in the 20-A series have voltage ratings from 50 to 150 v in 25-v increments. In addition to their extremely fast  $t_{rr}$  specifications and high peak-inverse-voltage ratings, the rectifiers are noteworthy for their low forward-voltage drops—0.9 v at 10 A. Depending upon voltage rating, prices of the devices range from \$8 each to \$16.50 each in small quantities. In hundreds, the prices drop to \$6.40 and \$13.20, respectively. Delivery is from stock.

TRW Power Semiconductors, 14520 Aviation Blvd., Lawndale, Calif. 90260 [419]

## Introducing new Great Jumpers™

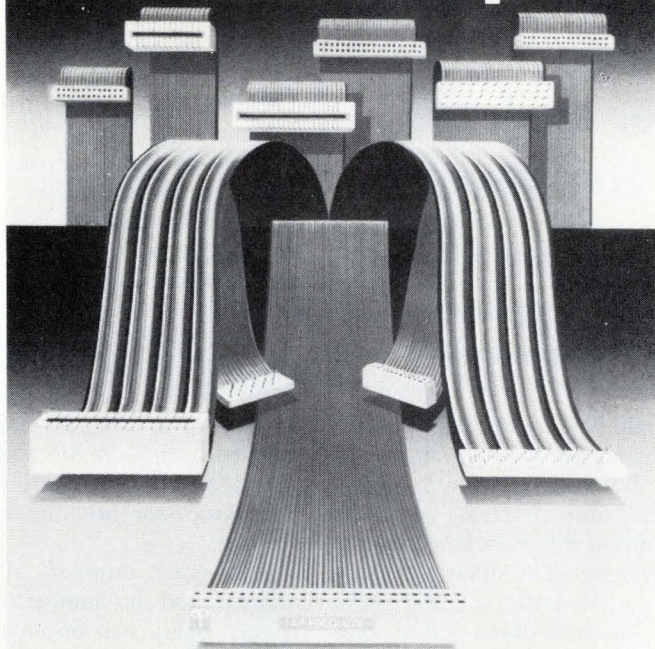

We've got the jump on any other  
flat cable/connector system.



Great Jumpers are the new ribbon cable/connector system that comes to you fully pre-assembled and fully pre-tested, yet can cost as little as half as much as those you're using now. We offer the three most popular connectors, the five most popular flat cable widths, solid or stranded Electric Pink or rainbow cable, single ended, double ended or daisy chained. And Great Jumpers are directly-interchangeable replacements for the jumpers you're using now.

### Faster and easier is what we're all about.

(201) 546-3660	(312) 298-4830	(513) 433-0966
(203) 868-7748	(313) 356-2161	(602) 946-4437
(206) 822-8223	(314) 434-6242	(602) 949-8424
(214) 238-0408	(315) 437-8343	(609) 429-4013
(215) 923-5195	(414) 421-2300	(612) 922-7011
(216) 333-4120	(415) 328-3232	(617) 272-8163
(219) 447-9623	(416) 638-1322	(713) 691-3961
(301) 484-5400	(503) 223-3374	(714) 560-6266
(303) 420-4646	(512) 443-9687	(714) 833-1802
(305) 894-3351		(816) 765-2998



### AP PRODUCTS INCORPORATED

Box 110-E Painesville, OH 44077 (216) 354-2101  
TWX: 810-425-2250

## New products

Instruments

### Tester analyzes microprocessors

Low-cost 32-channel recorder uses scope to display data in hexadecimal format

Logic analyzers have found a niche in testing and troubleshooting digital circuits, but their 0s and 1s or timing-diagram displays are less than optimum for examining microprocessor buses. The microprocessor analyzer, a variation of the logic analyzer, has been developed to meet the more specific needs of microprocessor hardware and software designers.

Scanoptik's Logicorder 32, for example, can handle 32 channels of digital data—enough for a microprocessor system's buses and a few auxiliary lines. The analyzer displays the activity in the unit under test in hexadecimal notation on the screen of a standard oscilloscope.

Priced at \$895, the Logicorder 32 stores two "pages" of data, each page consisting of 32 words. It

requires an external source of  $\pm 5$ -v power or can plug into a Tektronix TM-500-series mainframe.

Data is fed from the unit under test to the analyzer via three 16-conductor ribbon cables. Two of the ribbon cables handle data lines, and a third cable handles the clock signal, which can have a maximum frequency of 4 megahertz.

The microprocessor analyzer triggers a preset address, which can be either the first or last word on the display. The trigger can also be delayed by a set number of words so that the activity at any point in a microprocessor program can be examined.

The page number, the trigger address, and the number of words of trigger delay are displayed on the scope screen. In the manual mode, the entire display remains on the screen until the reset button is pushed. A new display appears when the address trigger and delay conditions are met. In the automatic mode, the display blanks after approximately one second, the analyzer waits for a new address trigger and delay, sets a new display, and the process repeats.

Scanoptik, Inc., P.O. Box 1745, Rockville, Md. 20850. Phone (301) 977-9660 [351]

### HP adds storage to 100-MHz portable scope

Retaining all of the attributes of the earlier model 1740A, Hewlett-Packard's model 1741A oscilloscope also includes variable-persistence and storage capabilities. The scope is thus particularly well suited to the capture and display of single-shot and low-repetition-rate waveforms commonly encountered in digital circuitry. The variable-persistence mode is useful in integrating waveforms with low repetition rates into clear displays, while the storage mode is for single-shot events. An auto-erase mode allows the 1741A to produce single-shot displays sequentially at rates up to one per second. Frequency response of the 1741A ranges to 100 megahertz at a sensi-

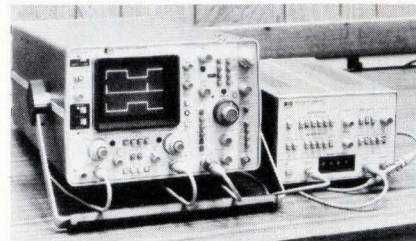

tivity of 5 millivolts per division. A  $5\times$  magnifier yields a sensitivity of 1 mV/division up to 30 MHz.

The scope uses a new cathode-ray tube and control electronics that produce a good trace-to-background ratio under most input conditions. A dynamic-feedback current-limiting circuit protects the CRT against burns. With this circuitry, the intensity may be increased for the viewing of fast traces with no danger that slow traces will then burn the screen. The 1741A sells for \$3,950; delivery time is estimated to be 60 days.

Hewlett-Packard Co., 1501 Page Mill Rd., Palo Alto, Calif. 94304 [353]

### Portable meter tests transistors and FETs

A portable version of the popular Cricket transistor/FET tester, called the Pocket Cricket, uses a patented phase-inversion test to identify good transistors and field-effect transistors. Transistors that pass the gain test cause the tester both to emit a test tone and to swing its meter pointer upward. After a device is known to be good, its polarity can be

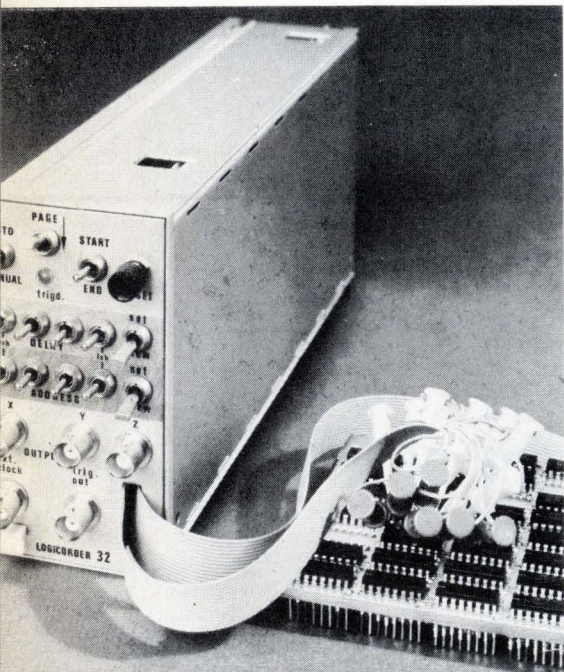

# Buss Fuses Specialize Too!

with a complete line in protecting  
telephone · communications and  
similar equipment

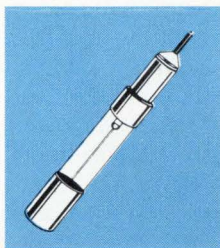
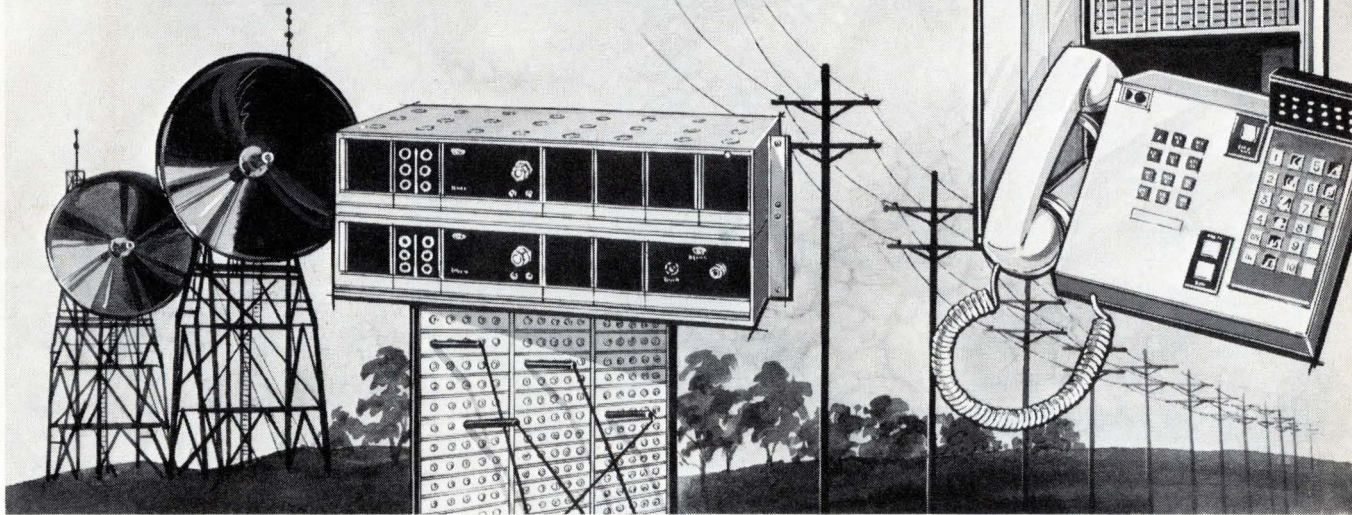

## **BUSS Series 70 FUSES**

... signal indicating, alarm activating — designed to give positive contact on the alarm circuit. Indicating pin is color coded for quick identification of ampere rating. Available from 18/100 to 10 amp., rated 300 V or less.

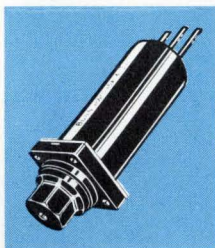

## **BUSS HWG FUSEHOLDER**

... especially designed to take Series 70 fuses. Bayonet type knob has hole for fuse indicating pin. Holder can be mounted from front or back of panel or cantilever from rear. Metal shoulder plate and strap on holder provides strength for mounting screws. Terminals can be wire wrapped or soldered. Rated 10 amp. 300 V or less.

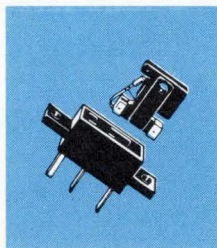

## **BUSS GMT FUSES and HLT FUSEHOLDER**

... for multiple circuit apparatus where space is at a premium. Holder takes mounting space of only 1/4"x1-15/32". Fuses are color coded and are signal indicating, alarm activating. Available from 18/100 to 10 amp., rated 300 V or less.

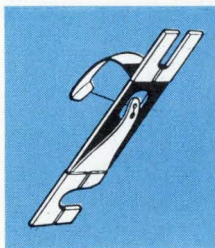

## **BUSS GRASSHOPPER FUSES**

... visual indicating, alarm activating — designed to give positive contact on the alarm circuit. Fuses are color coded for type and ampere. Available from 18/100 to 5 amp., rated 90 & 100 volts or less.



## **BUSS WER FUSES**

... insulated base has copper clad, tinned terminals slotted for #10 screws. Fuse link clearly visible for quick identification of open fuse. Ampere rating stamped on fuse for positive identification. Available from 1/4 to 10 amp., rated 32 volts or less.

Write today for your copy of *BUSS Bulletin COM-X*



**BUSSMANN MANUFACTURING**  
a McGraw-Edison Company Division  
St. Louis, Missouri 63107



# RF-PACKAGES — MICROWAVE SYSTEMS

## AUTOTRACK ANTENNA SCR-584 RADAR SYSTEM

360 deg AZ 210 deg EL. 1 mil. accuracy. Missile vel. accel. and slew. rates. Amplitude control. Handle up to 20 ft. dish. Compl. control chassis. ALSO in stock 10 cm. van mounted rad. system. Conical scan. PPI. 6 ft. dish. 300 pg. instr. bk. on radar 525



### RF SOURCES

CW: 300-535KHz 500W; 2-30MHz 3KW; 4-21MHz 40KW; 24-350MHz 100W; 385-585MHz 1KW; 750-985MHz 10KW; 95-8.8GHz 150W; 1-1.5GHz 110W; 1.7-2.4GHz 10KW; 4.4-5GHz 1KW; 8.8-11GHz 200W. Many more.

UHF: 1 Megawatt 210-225MHz 5μsec 180 PPS; 14KW 400-420MHz .002DC; 1KW 400-700MHz .002DC.

L BAND: 1KW 1-1.5GHz .1DC; 500KW 1.2-1.35GHz 2μsec 400PPS. Many more. Phone or write.

S BAND: 1KW 2.4-2.6GHz 75μsec 1200PPS; 250KW 2.7-3.1GHz 8μsec 1600PPS; 1 Megawatt 2.7-2.9GHz 1μsec 1200PPS; 5 Megawatts 2.75-2.85GHz 2.5μsec 400PPS.

C BAND: 225KW 6275-6575MHz 4μsec 680PPS; 250KW 5.4-5.8GHz 5μsec 680PPS; 1 Megawatt 6GHz 1μsec 1000PPS; 10 Megawatt 5.4-5.8GHz 5-10 μs 400 PPS.

X BAND: 100W 9.2-9.5GHz 5μsec 1000PPS; 1 KW 8.9-9.4GHz .001DC; 65KW 8.5-9.6GHz .001DC; 250KW 8.5-9.6GHz .0013DC; 400KW 9.1 GHz 1.8μsec 450PPS. Many more. Phone or write.

Ku-K BAND: 50KW 16.4-16.6GHz .001DC; 135KW 15.5-17.5GHz .0006DC; 40KW 24GHz .0007DC; 40KW 35GHz .0004DC. Many more. Phone or write.

### PULSE MODULATORS + H.V.P.S.

245 KW LINE Output 16 KV 16 A. .25 μs 4000 PPS.  
405 KW FLOATING DECK Output 20 KV 20 A 1 μs to 10 millisecond pulse.

500 KW LINE Output 22 KV 28 A. 4/1.75/2.25 μs 2500/550/300 PPS.

1 MW HARDTUBE MIT MODEL 9 Output 25 KV at 40 A. 25 μs .002 D.C.

2.0 MW LINE 30 KV 70 A. 1/2 μs 600/300 PPS.

3 MW LINE Output 39 KV 75 A. .25/1 μs 500 PPS.

10 MW LINE 76 KV 135 A. 2.5 μs 350 PPS.

17 MW LINE 17 KV 1000 A. 2-5 μs 150-2000 PPS.

66MW LINE 160 KV 400 A. 5-10 μs 400 PPS.

SEND FOR FREE 20 PG. CATALOG

## AN/MPS-19 S Band Tracker

Pwr: 500 KW. Range: 100 miles. Display: PPI and "A" scopes. 8' dish. Heilhut mounted.

### RADAR SYSTEMS

K BAND MONOPULSE 40KW E-34  
KU BAND SEARCH 135KW B-58  
X BAND MISSILE CONTROL NIKE AJAX/HERC  
X BAND HI-RES. MONOPULSE TRACKER  
X BAND FIRE CONTROL 250KW M-33  
X BAND WEATHER/SEARCH 250KW AN/CPS-9  
X BAND AIRBORNE TRACKER 50KW B-47  
X BAND MOBILE TRACKER 40KW AN/MPQ-29  
X BAND WEATHER/SEARCH 40KW AN/SPN-5  
X BAND ANTI-INTRUSION 7 KW AN/TPS-21  
X BAND ANTI-INTRUSION CW DOPPLER AN/PPS-9/12  
X BAND TRANSPONDER 100W AN/DPN-62  
C BAND HGT. FDR. 5MW FPS-26; 1MW TPS-37  
C BAND SEARCH 285KW AN/SPS-5B/D  
S BAND HEIGHT FINDER 5MW AN/PPS-6  
S BAND SEARCH COHERENT 1MW AN/PPS-18  
S BAND ACQUISITION 1MW NIKE AJAX/HERC  
S BAND TRACKER 10' DISH 500KW AN/MPQ-18  
S BAND MORTAR LOCATOR 250KW AN/MPQ-10A  
S BAND TRACKER 250KW AN/MPS-9  
L BAND SEARCH 40' ANTENNA 500KW AN/FPS-75  
L BAND SEARCH 500KW AN/TPS-10/GSS-1  
UHF SEARCH 1MW TPS-28

### DRONE CONTROL SYSTEMS

UHF COMMAND SYSTEM AN/URW-14  
X BAND DATA LINK AN/UPW-1  
X BAND TRACKER AN/MPQ-29  
X BAND TRACKER AN/MSQ-51

### 60 FT. DISH

Complete with Az-El pedestal, ready for installation. Immed. delivery. Write or call.

### SPARE PARTS IN STOCK

Nike Ajax, Nike Hercules, M-33, MPS-19, TPS-ID, TPS-10D, FPS-6, SPS8, SCR-584, HIPAR. Many more; write



**Radio  
Research  
Instrument  
Co., Inc.**

3 QUINCY ST., NORWALK, CONN. 06850  
(203) 853-2600

Circle 138 on reader service card

## NON-CONTACT AC & DC CURRENT SENSORS

NEW

UNIQUE

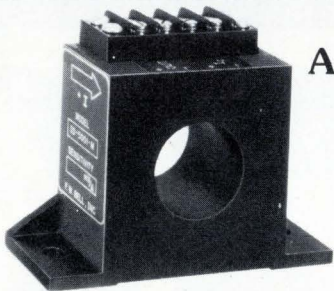

This new Bell current sensor has unique capabilities to solve current measurement problems. The following four capabilities allow the use of ID-5001M current sensors where other current sensing methods are difficult or impossible.

- 1) Non-contact operation provides complete isolation from the bus.
- 2) The ID-5001M introduces a negligible power drain in the measured circuit.
- 3) The minimal insertion impedance has virtually no effect upon the measured circuit performance.
- 4) The dc current capability allows the measurement of dc, ac, ac on dc, or dc on ac wave forms.

The standard current range is 350 amperes peak ac and dc. Response time is less than 50 microseconds and linearity is better than 2% of full scale. Other models are available to 2,000 amperes and to 100,000 amperes. For more detailed information, please use the inquiry card.

SEE US AT WESCON!

F. W. Bell, Inc.  
4949 Freeway Drive East  
Columbus, Ohio 43229  
614/888-7501

A subsidiary of The Arnold Engineering Company

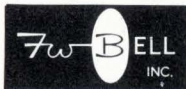

## New products

determined, and the user can distinguish a conventional transistor from an FET. The Pocket Cricket also measures all inter-element leakages and identifies transistor leads. The battery-operated unit is claimed to be completely safe, not only to the user, but also to the unit under test. The model TF40 Pocket Cricket sells for \$98. Each instrument is supplied with a training tape.

Sencore Inc., 3200 Sencore Dr., Sioux Falls, S. D. 57107. Phone Robert Bowden at (605) 339-0100 [354]

8-channel logic analyzer

stores 252 bits per channel

Operating at clock rates as high as 20 megahertz, the model 6211 logic scope is an eight-channel instrument that can store 252 bits for each channel. Up to four of the eight channels can form a trigger word. The analyzer can display events that occur up to 240 bits before the trigger or up to 3,840 bits after it. In addition to input triggering, the 6211 can be operated from an external trigger or in a free-running mode. A latching mode enables the instrument to capture glitches as short as 20 nanoseconds and stretch them to a full bit width. The logic scope sells for \$3,728.

Dumont Oscilloscope Laboratories Inc., 40 Fairfield Pl., West Caldwell, N. J. 07006. Phone (201) 575-8666 [355]



Logic analyzer is  
microprocessor-oriented

The 1625A logic analyzer can be triggered like any other such instrument—by its 16 input channels or by an external signal. In addition, it can be triggered by a second set of 16 inputs connected to a microprocessor input/output bus. Combining features of timing-diagram and truth-table displays, the display on the 1625A contains a timing diagram and a movable cursor. A column of 1s and 0s to the right of the timing diagram displays the 1s and 0s of the data at the cursor position. A dashed cursor shows the position of the trigger word, while the trigger word and trigger address are displayed alongside the cursor data at the right of the screen. Capable of handling two logic families at the same time, the 1625A sells for \$4,600. Delivery time is 60 days.

Vector Associates Inc., 685 Station Rd., Bellport, N. Y. 11713. Phone Sheldon Bienstock at (516) 286-9000 [357]

## TOPICS

### Instruments

**Philips Test & Measuring Instruments Inc., Woodbury, N.Y.**, has recently announced price reductions ranging from 12% to 20% on its PM6610 series of universal frequency counters.

... **Gralex Industries Division of General Microwave Corp., Farmingdale, N.Y.**, has reduced the prices of its series 37 digital panel meters in quantities of fewer than 24. The reductions range from a minimum of \$4 to as much as \$20. ... **Hewlett-Packard Co., Palo Alto, Calif.**, has lowered the price of its model 5451B digital Fourier analysis system from \$50,000 to \$41,000. The 18% price cut is attributable to savings in the development of a less expensive analog-to-digital converter and the inclusion of software configured only for the customer's specific requirements.

# Balco

DIVISION

Capacitors for  
Time Circuits  
Delay Lines  
R. C. Oscillators  
Integrators

- Smallest Size
- Exceptional Performance
- Low Cost
- Fast Delivery
- Long Term Stability

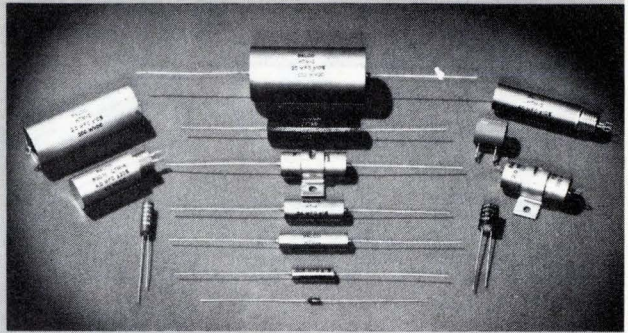

Style Parameters	Clear and Metalized Teflon® types. Extended Foil (RTWGX)	Metalized Film (RTWGMX)
Capacitance Range ( $\mu\text{F}$ )	0.0005 to 2.0	0.05 to 4.0
Working Voltage (Vdc)	50 to 600	50 to 600
Temperature Coefficient	$\pm 1.5\%$	$-90 \text{ PPM}/^\circ\text{C} \pm 40$
DF at 25°C and 1 kHz (%)	0.05	0.1
Operating Temperature Range ( $^\circ\text{C}$ )	$-55 \text{ to } +175$	$-55 \text{ to } +175$
Dielectric Absorption (%)	$< 0.05$	$< 0.05$
IR (Ohms)	$> 1 \times 10^{12}$	$> 1 \times 10^{10}$

Contact Custom for capacitors to suit your applications. Write for Brochure



**CUSTOM ELECTRONICS, Inc.**

Balco Division  
12 Browne Street, Oneonta, N.Y. 13820  
Ph: 607-432-3880 TWX: 510-241-8292

Circle 139 on reader service card

# 6 Proven Ways To Better Your Profits\*

- Manufacturer's wage rates: \$2.50-4.50 per hour
- Property cost \$4,000 to \$20,000 an acre
- State corporate income tax only 5%
- No state income tax
- Right to work law - yes
- Low tax rates; building and property; city, 3.38; county 11.99 mills

## Ocala/Silver Springs FLORIDA

(\*And More - Write for your FREE copy of "Profit Facts")

NAME \_\_\_\_\_ TITLE \_\_\_\_\_  
 COMPANY \_\_\_\_\_  
 ADDRESS \_\_\_\_\_ PHONE \_\_\_\_\_  
 CITY \_\_\_\_\_ STATE \_\_\_\_\_ ZIP \_\_\_\_\_

Industrial Development Div. COMMITTEE OF ONE HUNDRED  
 P. O. Box 495-B, Ocala, Florida 32670

In cooperation with the Florida Department of Commerce

# Talk to the 32,329 decision-makers in Japan's electronics industry.

# 翻訳

## We'll furnish the language.

If you want to reach the most influential group of management and professional electronics engineers in Japan, we're certain you couldn't choose a more important medium than Nikkei Electronics. Or a more helpful one, either.

When you're thinking about selling to our 32,329 decision-makers, we offer you our full communications resources.

For instance, we'll translate your advertising message from English into the kind of Japanese that we know gets results from our readers. Then we'll set type for you. Also lay out the entire ad for you. And, wonder of wonders, there's no extra charge for these services.

Speaking the precise language of our very important readership is just one of the ways Nikkei Electronics gets more value for your yen in Japan.

As the bi-weekly product of Japan's largest business-economic newspaper and McGraw-Hill, Inc., we're by far the most-respected magazine in our field. (About

30% of our material is a translation of specialized contents from U.S. *Electronics*.)

As the only Japanese electronics magazine that's a member of the Japan Audit Bureau of Circulation, we can guarantee exclusivity as well as readability.

Our reader profiles are computer-

controlled. The better to provide you with up-to-the-minute information on purchasing patterns, reader

analysis studies and proper market approaches.

And our Reader Information Service is a masterpiece of effectiveness. As many as 3,388 responses per issue, with 57.4% of the respondents acknowledging that they participate in or influence the purchasing decision of their companies.

Talk to the electronics decision-makers of Japan in our pages. We'll even furnish the language. Contact Mr. H.T. Howland (in English), Marketing Services Manager, Electronics, McGraw-Hill Publications Company, 1221 Avenue of the Americas,

New York, N.Y. 10020. Telephone: (212) 997-6642. Or talk to any member of McGraw-Hill's advertising sales staff in the U.S. or Europe, or contact us directly in Japan.

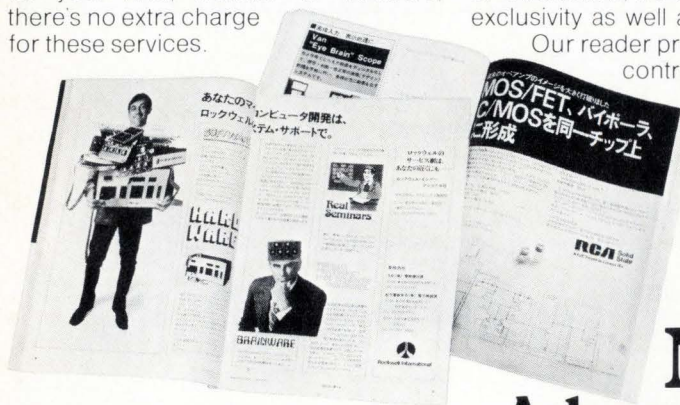

## Nikkei Electronics: Ask anybody who can read us.

## New products/materials

An epoxy potting compound formulated especially for potting and encapsulating cable connectors and plugs, Tra-Cast 3033 is a solvent-free, two-part system that adheres well to most of the metals, elastomers, and plastics commonly used in connectors and cables. The low-viscosity resin system has a 20-minute pot life and cures overnight at room temperature (25°C). Intended for use in telephone and electrical cables, the material retains its mechanical strength, electrical resistivity, and chemical inertness over the temperature range from -60°C to 120°C. It is supplied in pre-measured Bipax packages.

Tra-Con Inc., Resin Systems Division, 55 North St., Medford, Mass. 02155 [476]

**Arsenic spin-on dopant** solution, Accuspin, is claimed to be the safest material for the arsenic-doping of semiconductors. Intended primarily for bipolar buried-layer collector diffusion, it may also be diluted for controlled lower doping levels.

Allied Chemical Corp., Specialty Chemicals Div., P.O. Box 1087R, Morristown, N.J. [477]

**Heat-shrinkable tubing** made of TFE Teflon is available in standard expanded sizes from 1 millimeter to 26 mm. Called Penntube I-TTO, the tubing must be heated to 621°F or more for proper shrinkage. It is noteworthy for its chemical inertness, low coefficient of friction, excellent insulating properties, and high-temperature (500°F) capabilities.

Penntube Plastics Co., Clifton Heights, Pa. 19018. Phone (215) 622-2300 [478]

**Ceramic substrates** for thick-film circuits are said to be fine enough to allow thick- and thin-film hybrids to be combined on the same substrate. In particular, Superstrate 960 has a camber of no more than 3 mils per inch, a grain size of less than 2 micrometers, a surface finish of 6 to 8 microinches CLA, and a density of 3.74 to 3.77 grams per cubic centimeter. Production quantities require from 30 to 60 days for delivery.

Materials Research Corp., Orangeburg, N.Y. 10962. Phone (914) 359-4200 [479]

## Another price breakthrough! Slanted fin coolers for TO-3

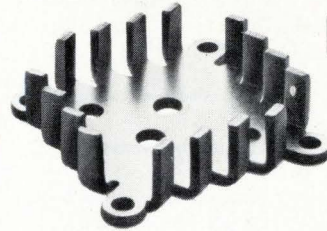

packages -  
only  
16¢ each.

Here's a new family of slanted fin coolers for high-density circuit board packages that matches competition spec for spec—at less than one half the price.

Wakefield's new Series 689 slanted fin coolers are directly interchangeable with Thermalloy's 6001 series and replace other TO-3 heat sinks, yet, thanks to new automatic tooling, cost only 16¢ each in 5000 quantity.

### Try one free:

See for yourself. Indicate your specs, then cut out and mail for a free sample.

Height:  .50"  .75"  1.00"  1.25"  
Finish:  Plain  Black Anodize  
Configuration:  TO-3 Standard  TO-3 (8 pin)  
 TO-66  TO-220



### WAKEFIELD ENGINEERING INC.

77 AUDUBON ROAD, WAKEFIELD, MA 01880 (617) 245-5900  
TWX 710-348-6713 AN E&G COMPANY

Cut out and mail for a free sample.

Circle 141 on reader service card

## Classified section

FOR EMPLOYMENT  
AND SALES OPPORTUNITIES

### POSITIONS VACANT

**Position Available—Need BS Eng.** + U.S. exper. in engineering or technical sales. Fee paid by employer. Over 1,000 U.S. client co's. Est. 1959. Send resume & present salary. Atomic Personnel, Inc., Box L, 1518 Walnut, Phila, PA 19102.

**Graduate Assistantships in Physics** can begin during any quarter. Write: Dr. R. Madey, Kent State University, Kent, OH 44242.

### EMPLOYMENT SERVICE

**Electronics' Industry Newsletter** tells you which firms have current employment opportunities, in the field of Electronics, for all types of Engineers, Sales Representatives, Technicians, Executives, Computer Personnel and others. Latest product information is also reported. For information write: Electronics' Industry Newsletter, Dept. 304A, 23573 Prospect Avenue, Farmington, MI 48024.

## Gas Sensing Semiconductor

# FIGARO GAS SENSOR

**TGS** quickly senses  
even small  
amount  
of gas.

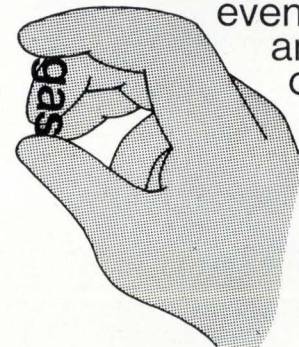

New Models,  
some with highly sensitive  
CO sensor, now on the market.

Please contact the address below directly for  
catalogs and price/delivery information.

### FIGARO ENGINEERING INC.

3-7-3, Higashitoyonaka, Toyonaka City, Osaka 560,  
Japan/Tel: (06) 849-2156  
Cable: FIGARO TOYONAKA/ Telex: 05286155 FIGARO J

# Electronics advertisers

August 5, 1976

■ Abbott Transistor Labs Inc.	6	■ Erie Technological Products Co. Inc.	73	° Rohde & Schwarz	1E
Advanced Micro Devices	10,11	Fabri-Tek Inc.	69	Sangamo Electric	72
■ Airpax Electronics	71	Fairchild Semiconductor Inc.	28,29	■ Sensors Inc.	132
Allen Bradley Company	24	Figaro Engineering Inc.	141	‡ Siemens Corporation	22,23
Alphatron, Inc.	118	■ Galileo Electro-Optics Corp.	128	‡ Siemens Computest	115
° Amphenol Tuchel	15	General Electric Instrument Rental Division	116	Simpson Electric Company	41
■ AMP Incorporated	18,19	General Magnetics	144,	Singer Company Kearfott Division	131
■ AP Products Incorporated	135	■ Grayhill Inc.	40	Systron Donner Concord Instrument	105
Belden Corporation	121	Gulf Power Company	134	■ Teledyne Relays	17
■ Bell, F.W.	138	Hermes Electronics, Ltd.	30	Teletype	119
■ Bourns Inc.	3rd C	■ Hewlett-Packard	1,2,21,66,80	United Systems Corp. a Sub of Monsanto Co.	130
■ Bowmar Instrument Corp.	122	Honeywell Test Instrument Division	75	■ Vactec Inc.	125
Brand Rex Corporation	2nd C	■ Hughes Aircraft Company	42,43	■ Valtec	113
‡ MGR/Bussmann Mfg. Co.	137	Icom, Inc.	39	Varo Semiconductor Inc.	133
Chicago Miniature Lamp/Works	20	Intel Corporation	35	Wakefield Engineering Inc.	141
■ Clairex Electronics	4th C	International Crystal Manufacturing Company	76	Wima Westermann	16
Committee of One Hundred, Chamber of Commerce of Ocala,	139	■ International Rectifier Corp., Semi Div.	44,45	Zilog	126-127
° ■ Communication Associates Inc.	48	■ Interstate Electronics Corp.	13	<b>Classified &amp; Employment Advertising</b>	
■ Continental Rentals	8	■ Ithaco, Inc.	7	F. J. Eberle, Manager 212-997-2557	
■ Custom Electronics Inc.	139	‡ ITT Components Group	48	■ Radio Research Instrument Corporation 138	
‡ Cutler-Hammer Inc.	123	■ Kepco Inc.	5		
° ■ Dale Electronics Inc. A Subsidiary of Lionel Corporation	15	° Membrain Limited	23		
Data General Corporation	27	Monolithic Memories Inc.	54		
Data Tech	46,47	■ Motorola Semiconductor Products Inc.	51,77		
‡ Deltron	52	‡ Nikkei Electronics	140		
■ Dialight Corporation	79	■ Permag Corporation	143		
Digital Equipment Corporation (OEM)	57-64	° Philips Elcoma	52		
Eastman Chemical Corp.	8	■ Power/Mate Corp	157		
‡° Eastman Kodak Company Graphics Division	15	Projects Unlimited Inc.	113		
E.I. DuPont De Nemours & Co Inc.	9	Radio Research Instrument Company	138		
■ Electronics Memories and Magnetics Corporation	109	RCA Solid State Division	37		
Electronic Navigation Industries	38	■ RCL Electronics Inc.	14		

■ For more information of complete product line see advertisement in the latest Electronics Buyers Guide  
 ° Advertiser in Electronics International  
 ‡ Advertiser in Electronics domestic edition



## Advertising Sales Staff

**Pierre J. Braudé** New York [212] 997-3468  
Paris Tel: 720-73-01  
Director of Marketing

**Atlanta, Ga. 30309**  
100 Colony Square, 1175 Peachtree St., N.E.  
[404] 892-2868

**Boston, Mass. 02116:** James R. Pierce  
607 Boylston St. [617] 262-1160

**Chicago, Ill. 60611:**  
645 North Michigan Avenue  
Robert W. Bartlett (312) 751-3739  
Robert M. Denmead (312) 751-3738

**Cleveland, Ohio 44113:** William J. Boyle  
[716] 586-5040

**Dallas, Texas 75201:**  
2001 Eryant Tower, Suite 1070  
[214] 742-1747

**Denver, Colo. 80203:** Harry B. Doyle, Jr.  
123 Speer Blvd. # 400  
[303] 837-1010

**Detroit, Michigan 48202:** Robert W. Bartlett  
1400 Fisher Bldg.  
[313] 873-7410

**Houston, Texas 77002:** Paul Reiss  
601 Jefferson Street, Dresser Tower [713] 659-8381

**Los Angeles, Calif. 90010:** Robert J. Rielly  
Bradley K. Jones, 3200 Wilshire Blvd., South Tower  
[213] 487-1160

**New York, N.Y. 10020**  
1221 Avenue of the Americas  
Warren H. Gardner [212] 997-3617  
Michael J. Stoller [212] 997-3616

**Philadelphia, Pa. 19102:** Warren H. Gardner  
Three Parkway,  
[212] 997-3617

**Pittsburgh, Pa. 15222:** Warren H. Gardner  
4 Gateway Center, [212] 997-3617

**Rochester, N.Y. 14534:** William J. Boyle  
9 Greylock Ridge, Pittsford, N.Y.  
[716] 586-5040

**San Francisco, Calif. 94111:** Don Farris  
Robert J. Rielly, 425 Battery Street,  
[415] 362-4600

**Paris:** Alain Offergeld  
17 Rue-Georges Bizet, 75 Paris 16, France  
Tel: 720-73-01

**Geneva:** Alain Offergeld  
1 rue du Temple, Geneva, Switzerland  
Tel: 32-35-63

**United Kingdom & Scandinavia:** Robert Ghey  
Tel: 01-493-1451, 34 Dover Street, London W1

**Scandinavia:** Andrew Karnig and Assoc.  
Kungsholmsgatan 10  
112 27 Stockholm, Sweden  
Tel: 08 51 68 70 Telex: 179 51

**Milan:** Luigi Rancati  
1 via Baracchini, Italy Phone 86-90-656

**Brussels:** Alain Offergeld  
23 Chaussee de Wavre  
Brussels 1040, Belgium  
Tel: 13-73-95

**Frankfurt/Main:** Fritz Krusebecker  
Liebigstrasse 27c, Germany  
Phone 72 01 81

**Tokyo:** Tatsumi Katagiri, McGraw-Hill  
Publications Overseas Corporation,  
Kasumigaseki Building 2-5, 3-chome,  
Kasumigaseki, Chiyoda-Ku, Tokyo, Japan  
[581] 9811

**Australasia:** Warren E. Ball, IPO Box 5106,  
Tokyo, Japan

## Business Department

**Thomas M. Egan,**  
Production Manager [212] 997-3140

**Carol Gallagher**  
Production Manager International [212]  
997-2045

**Dorothy Carter,** Production Manager Do-  
mestic  
[212] 997-2908

**Frances Vallone,** Reader Service Manager  
[212] 997-6057

## Electronics Buyers' Guide

**George F. Werner,** Associate Publisher  
[212] 997-3139

**Regina Hera,** Directory Manager  
[212] 997-2544

# HAVE A FERRITE DELIVERY PROBLEM?



## ...LOOK TO PERMAG

With Permagan supplying application –  
rated Indiana General Corp. Ferramics,™  
you'll always get exactly what you need.  
Complete fabricating facilities.  
Prototype quantities available. Plus,  
engineering assistance, field testing.  
Prompt 24-hour delivery.  
Extensive stock of ferrite parts  
at all locations. New catalog available.



Consult your Yellow Pages for address and telephone number of Permagan near you.

Circle 143 on reader service card

## 33% more power to the people. Power/Mate presents Econo/Mate II.

### The open frame power supply.

Now Power/Mate brings you 33%  
more power in the same package size  
with the second generation of our  
Econo/Mate series.

The size is the same, the basic  
components are the same for easy  
interchangeability. But that's where the  
similarity ends.

Econo/Mate II adds features like  
dual AC primary and a plug-in IC  
regulator for improved regulation.

And Econo/Mate II is tough.  
Computer design, quality control, and  
Power/Mate's experience helps  
insure 100,000 hr. MTBF even at this  
higher power output.

But for all its features, Econo/Mate  
II is still, most of all, economical.  
We wouldn't call it Econo/Mate  
if it wasn't.

Econo/Mate II is in stock, ready for  
delivery. Send for our free brochure.

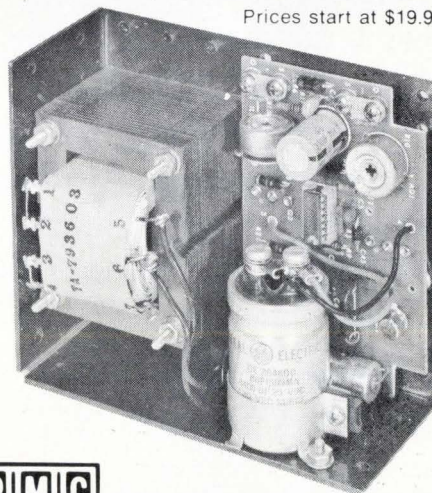

Prices start at \$19.95.



## POWER/MATE CORP.

World's largest manufacturer of quality power supplies

514 South River Street/Hackensack, N.J. 07601/Phone (201) 343-6294 TWX 710-990-5023

# SOLID STATE 3 WIRE SYNCHRO TO LINEAR D.C. CONVERTER



## RESPONSE CURVE

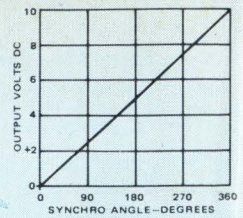
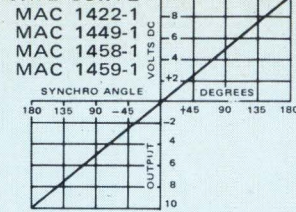

RESPONSE CURVE

MAC 1460-1  
MAC 1461-1

## FEATURES:

- Develops a DC output voltage linearly proportional to a synchro angle over a  $\pm 180^\circ$  range.
- Completely solid state with all of the inherent advantages over a mechanical system such as:
  - High reliability (since there are no moving parts)
  - Light weight—6 ozs.
  - Small size
  - All units hermetically sealed

- Wide temperature range operation
- Output short circuit protected
- Three wire inputs isolated from ground
- Package size may be altered at no extra cost
- Units can be altered to accept different line to line voltages or different operating frequencies at no extra cost
- Not affected by reference voltage or power supply variations.

UNIT	MAC 1422-1	MAC 1449-1	MAC 1458-1	MAC 1459-1	MAC 1460-1	MAC 1461-1
TRANSFER EQUATION	$\pm IV/18^\circ$	$\pm IV/18^\circ$	$\pm IV/18^\circ$	$\pm IV/18^\circ$	$+IV/36^\circ$	$+IV/36^\circ$
ACCURACY (+25°C)	½%	½%	½%	½%	½%	½%
ACCURACY (-25°C +85°C)	1%	1%	1%	1%	1%	1%
L - L SYNCHRO INPUT (VRMS)	11.8	90	11.8	90	11.8	90
FREQUENCY (Hz)	400	400	60	60	400	400
FULL SCALE OUTPUT	$\pm 10V$	$\pm 10V$	$\pm 10V$	$\pm 10V$	+10V	+10V
OUTPUT IMPEDANCE	$<1\Omega$	$<1\Omega$	$<1\Omega$	$<1\Omega$	$<1\Omega$	$<1\Omega$
L - L INPUT IMPEDANCE	$>10K$	$>30K$	$>2K$	$>10K$	$>10K$	$>30K$
REFERENCE VOLTAGE (VRMS)	26	115	26	115	26	115
OPERATING TEMP. °C	-25 - +85	-25 - +85	-25 - +85	-25 - +85	-25 - +85	-25 - +85
D.C. SUPPLY	$\pm 15V$	$\pm 15V$	$\pm 15V$	$\pm 15V$	$\pm 15V$	$\pm 15V$
D.C. SUPPLY CURRENT	$\pm 75MA$	$\pm 75MA$	$\pm 75MA$	$\pm 75MA$	$\pm 75MA$	$\pm 75MA$
BANDWIDTH	10Hz	10Hz	OPT.	OPT.	10Hz	10Hz
WEIGHT	6 oz.	6 oz.	6 oz.	8 oz.	6 oz.	6 oz.
SIZE	3.6x2.5x0.6	3.6x2.5x0.6	3.6x3.0x0.6	3.6x3.0x1.0	3.6x2.5x0.6	3.6x2.5x0.6

## A.C. LINE REGULATION

A new method has been developed which allows us to provide a low distortion highly regulated AC waveform without using tuned circuits or solid state active filters of any kind.

The result is a frequency independent AC output regulated to 0.1% for line and load with greater than 20% line variations over a wide temperature range.

## FEATURES:

- 0.1% total line and load regulation
- Independent of  $\pm 20\%$  frequency fluctuation
- 1 watt output
- Extremely small size
- Isolation between input and output can be provided

Specifications: Model MLR 1476-1

AC Line Voltage: 26V  $\pm 20\%$  @  
400Hz  $\pm 20\%$

Output: 26V  $\pm 1\%$  for set point

Load: 0 to 40ma

Total Regulation: +0.1%

Distortion: 0.5% maximum rms

Temperature Range:  $-55^\circ C$  to  
 $+125^\circ C$

Size: 2.0" x 1.8" x 0.5"

Other units are available at different power and voltage levels as well as wider temperature ranges. Information will be furnished upon request.

## SOLID-STATE SINE-COSINE SYNCHRO CONVERTER - NON VARIANT

This new encapsulated circuit converts a 3 wire synchro input to a pair of dc outputs proportional to the sine and cosine of the synchro angle independent of a-c line fluctuations.

- Complete solid state construction
- Operates over a wide temperature range
- Independent of reference line fluctuations
- Conversion accuracy—6 minutes
- Reference and synchro inputs isolated from ground

Specifications Model DMD 1508-2

Accuracy: Overall conversion accuracy 6 minutes. Absolute value of sine and cosine outputs accurate to  $\pm 30MV$

Temperature Range: Operating  $-40^\circ C$  to  $+85^\circ C$ , Storage  $-55^\circ C$  to  $+125^\circ C$

Synchro Input: 90V RMS  $\pm 5\%LL$  400Hz  $\pm 5\%$

DC Power:  $\pm 15V$  DC  $\pm 10\%$  @ 50MA

Reference: 115VRMS  $\pm 5\%$  400Hz  $\pm 5\%$

Output: 10V DC full scale output on either channel @ 5ma load

Temperature coefficient of accuracy:  $\pm 15$  seconds/ $^\circ C$  avg. on conversion accuracy  $\pm 1$  MV/ $^\circ C$  on absolute output voltages

Size: 2.0" x 1.5" x 2.5"

Units are available with wider temperature ranges and 11.8V LL, 26V reference synchro inputs. Information will be supplied upon request.

There is No Substitute for Reliability



# GENERAL MAGNETICS • INC

135 Bloomfield Ave., Bloomfield, New Jersey 07003 - Tel. (201) 743-2700

Circle 144 on reader service card