

Mini-Micro Systems

A CAHNERS PUBLICATION

DECEMBER 1985

SPECIAL REPORTS:

Optical storage shines on the horizon



Minis gain on supers with vector processors

Electronic publishing lands on the desktop

VME and Multibus: Packaging That Makes The Difference



Now there's a complete, integrated line of Multibus™ and VMEbus system enclosures that lets you match your system needs today — with the flexibility to expand or reduce your requirements in the future.

For Multibus, choose from visually-compatible 4, 7, 10, 12, and 15-slot enclosures with Multi-Cage® card cages and backplanes, all designed to meet FCC class A EMI/RFI requirements with typical systems installed. The 7-slot upright DeskMate™ and the 7-slot tabletop models have room for two half-height 5¼" peripherals, plus an additional 5¼" full height Winchester drive. All but the DeskMate are available for rack mounting.

For VMEbus, there are 3, 5, 7 and 12-slot models, with peripherals available on the DeskMate, rack mount and tabletop 5-slot versions. All use Electronic Solutions' VMEasy™ card cage and backplane design for rugged, reliable card mounting and easy servicing. If you're into Multibus now, you can even convert your enclosures later for VME.

Talk to us about your unique requirements. Build upon the industry's most comprehensive system of Multibus and VMEbus enclosures, and reduce your lead time to market. We'll provide front or rear card

loading, or special slot spacing, special power supplies, or I/O connections. See how our custom design gives you an entire enclosure line instead of a single box.

Electronic Solutions' entire line is backed by our three year limited warranty — your assurance of built-in reliability.

Call us today, and find out how Electronic Solutions can make the difference in *your* system packaging.

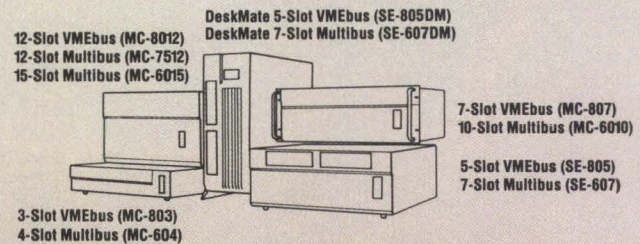



3 Year Limited Warranty

9255 Chesapeake Drive, San Diego, CA 92123 • (619) 292-0242 Telex II (TWX): 910-335-1169

Call Toll Free: (800) 854-7086 In Calif: (800) 772-7086

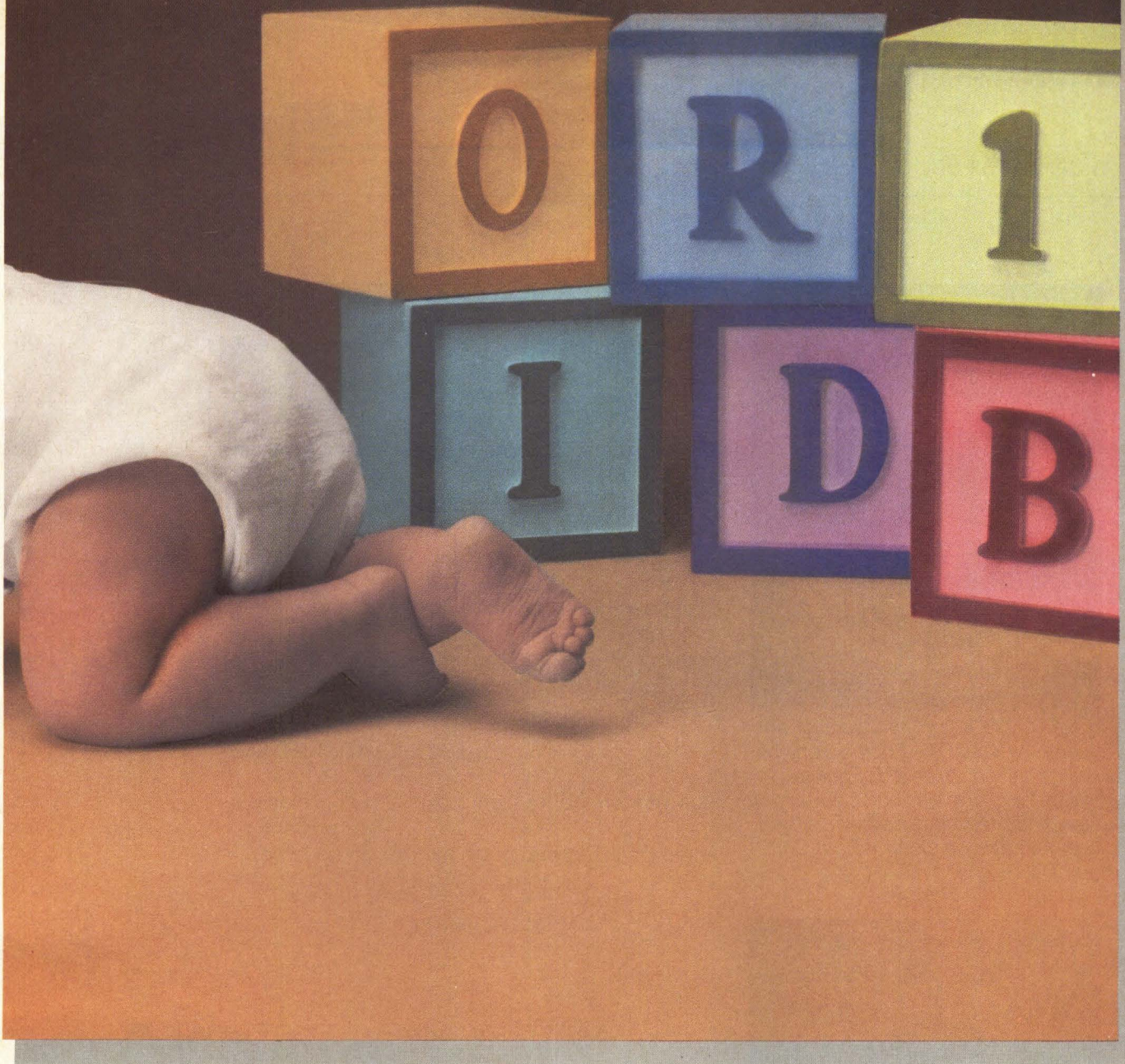
CIRCLE NO. 1 ON INQUIRY CARD



 SOFTWARE AG

When you're ready to leave the DBMS toys behind.

Software AG is ready with ADABAS(VMS) and NATURAL(VMS)—database management and information processing for VAX supermini-computers. Advanced software solutions that meet the requirements of a high-volume production environment. Call us today at 1-800-336-3761. (In Virginia and Canada, call 1-703-860-5050).

CIRCLE NO. 2 ON INQUIRY CARD

Please see us at Dexpo West Booth 738

 SOFTWARE AG

Where the future
comes as no surprise.

© 1985 Software AG of North America, Inc.
ADABAS and NATURAL are trademarks of Software AG of North America Inc.
VAX and VMS are trademarks of Digital Equipment Corporation.

mms1285



p. 68 Art direction and design by VISCOM. Photography by Presentations Unlimited. Special effects by Chart Masters. Courtesy of Optical Storage International. A joint venture between Control Data Corp. and N.V. Philips.



p. 53 LAN in the factory

NEWS/INTERPRETER

Tektronix places its bets on computer-based testing29

Has binary compatibility come to UNIX?31

Fault-tolerant computing tries to get less expensive.31

FCC reversal on AT&T separation.34

Masscomp responds to slump with multiprocessing38

GSS adds raster capability to its virtual device interface.42

Heard on the Hill: U.S. microelectronics top Soviet shopping lists . . .44

* EUROPEAN NEWS

Pick vendors go for high profile and new markets.E3

Anglo-Danish group plans full OSI network line E4

*Appearing in the European edition only

VERTICAL MARKET INTEGRATOR

LAN tightens factory floor control53

FEATURES

Feature Highlights67

Optical storage shines on the horizon68

Read-only write-once and erasable optical disk drives promise voluminous economical data storage, but lack of media standards and software hinders market acceptance

MINI-MICRO SYSTEMS (ISSN 0364-9342) is published monthly (with 4 special Digest issues) by Cahners Publishing Company, Division of Reed Holdings, Inc., 275 Washington St., Newton, MA 02158. Norman L. Cahners, Chairman; Saul Goldweitz, President and Chief Executive Officer; Ronald G. Segel, Executive Vice President and Chief Operating Officer. MINI-MICRO SYSTEMS is published by the Cahners Magazine Division: William Platt, President; Terrence McDermott, Executive Vice President. Circulation records are maintained at Cahners Publishing Co., 270 St. Paul St., Denver, CO 80206. Second class postage paid at Denver, CO 80202 and additional mailing offices. Postmaster: Send address changes to MINI-MICRO SYS-

Electronic publishing lands on the desktop85
 By combining microcomputers, page scanners and laser printers with specialized software, electronic publishing challenges traditional printing methods

Thin film challenges oxide media95
 A new breed of smaller, higher capacity rigid disks is thinning the herd of oxide-disk makers, but it's still not clear which species will reign

Minis gain on supers with vector processors107
 With architectures similar to the Cray 1, systems can perform like supercomputers in demanding applications at supermini prices

***DIGITAL DIRECTIONS**

ProductsD1

*Appearing in the DEC demographic edition only

DEPARTMENTS

Editorial Staff	4
Editorial	11
Breakpoints	17
New Products	117
Artful Intelligence	137
Career Opportunities	139
Classified Advertising	141
Index to Advertisers	143
Mini-Micro Marketplace	147

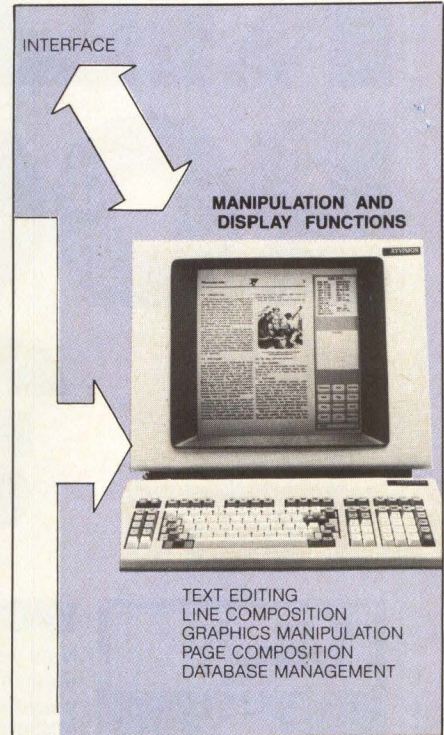

p. 85 EP produces high quality

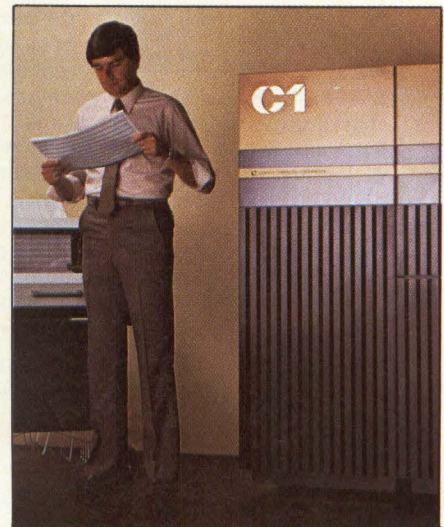

p. 107 Minis close the gap

TEMS, 270 St. Paul St., Denver, CO 80206. MINI-MICRO SYSTEMS is circulated without charge by name and title to U.S.- and Western European-based corporate and technical management, systems engineers, and other personnel who meet qualification procedures. Available to others at the rate of \$65.00 per year in the U.S.; \$70.00 in Canada and Mexico; \$95 surface mail in all other countries; air mail surcharge, \$35.00 (16 issues). Special DIGEST issues, \$15.00. Single issues \$5.00 in the U.S.; \$6.00 in Canada and Mexico; \$7.00 in all other countries.

© 1985 by Cahners Publishing Company, Division of Reed Holdings, Inc. All rights reserved.



WHO KILLED ROGET ?

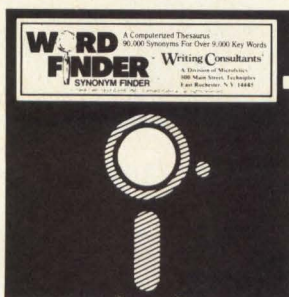

WORD FINDER did.

Now you can have the perfect word for your thought in seconds without taking your fingers off the keyboard. WORD FINDER is the electronic thesaurus that becomes an extra function *inside* your word processor. Whenever you give the command, WORD FINDER reads the word the cursor is on and pops open a window of synonyms. Pick one, and the new word replaces the old, *automatically*. WORD

FINDER provides 90,000 synonyms for over 9,000 words, nearly twice that of other thesaurus programs. Yet, WORD FINDER uses only 27K of RAM and keeps all the synonyms in a 157K file that can be kept on any disk drive. (A new, even larger database with 150,000 synonyms for 15,000 words will also be available in December, 1985.)

WORD FINDER will quickly help you make your point eloquently, clearly and concisely. So put pizzazz (punch, sizzle, flair) in your writing by putting WORD FINDER in your word processor, today.

WORD FINDER works inside most popular word processors,* and it's fast and easy to install. Just ask a writer:

WORD FINDER is an affordable adjunct for whipping (flogging, thrashing) your prose into shape quickly and efficiently, without leaving the document file you're working on.

—David Obregón, *PC Magazine*

*WordStar, WordStar 2000, Multimate, Word Perfect, Pfs:Write, Microsoft Word, IBM Writing Assistant, Easy Writer II, Framework, Volkswriter Deluxe, OfficeWriter, and Palantir. WORD FINDER is also available for WordStar on CP/M.



Writing Consultants™
a Division of Microlytics, Inc.™

Call 1-800-828-6293
Techniplex Center, Suite 486
East Rochester, NY 14445
in NY 716-377-0130

Available from your local dealer through

SOFTSEL

30 DAY, MONEY-BACK GUARANTEE.

Rush me **WORD FINDER** for \$79.95.
(Add \$2.50 shipping; NY residents add sales tax)

Visa
 MasterCard
 Check
 COD

Card Number _____ Exp. _____ Date _____ / _____ / _____
 Name _____ Phone _____
 Company _____
 Address _____
 City _____ State _____ Zip _____
 Word Processor _____ Computer/Op System _____

STAFF

Vice President/Publisher
S. Henry Sacks

Editor-in-Chief
George V. Kotelly

Managing Editor
James F. Donohue

Assistant Managing Editor
Bruce J. MacDonald

Senior Western Editor: **Jerry Borrell**
San Jose, (408) 296-0868
Senior Projects Editor: **Rick Dalrymple**

Western Editor: **Carl Warren**
Irvine, (714) 851-9422

Senior Associate Editor: **David Simpson**
European Editor: **Keith Jones**
London: (011-441-661-3040)

Associate Editor: **Frances T. Granville**
Associate Editor: **Lynn Haber**

Associate Editor/Research: **Frances C. Michalski**
Associate Western Editor: **Mike Seither**
San Jose, (408) 296-0868

Associate Editor: **Gregory Solman**
Associate Editor: **Michael Tucker**

Associate Editor: **Jesse Victor**
Assistant Editor/New Products: **Eileen Milauskas**
Assistant Editor/Research: **Pamela Gorski**
Assistant Editor/Research: **Megan Nields**

Contributing Editors

Raymond C. Freeman Jr.
Freeman Associates

Tokyo: **Ichiro Kakehashi**

Data Communications: **Walter A. Levy**
Washington, D.C.: **Stephen J. Shaw**
(202) 387-8666

Gene R. Talsky

Professional Marketing Management Inc.

Editorial Production

Senior Copy Editor: **Arsene C. Davignon**
Production Editor: **Mary Anne Weeks**
Assistant Copy Editor: **Sharon Hassell**

Editorial Services

Carey Highley, Terri Gellegos

Assistant to the Publisher: **Linda L. Lovett**

Art Staff

Art Director: **Vicki Blake**

Assistant Art Director: **Cynthia McManus**

Director of Art Dept.: **Norm Graf**

Production Staff

VP Production: **John Sanders**
Supervisor: **William Tomaselli**
Production Manager: **Susan Shaver**
Composition: **Diane Malone**

Editorial Offices

Boston: 275 Washington St., Newton, MA 02158, (617)964-3030. **Irvine:** 2041 Business Center Dr., Suite 109, Irvine, CA 92715. **Los Angeles:** 12233 W. Olympic Blvd., Los Angeles, CA 90064. **San Jose:** 3031 Tisch Way, San Jose, CA 95128. **London:** P.O. Box 37E, Worcester Park, Surrey, KT4 8RQ, England.

Reprints of Mini-Micro Systems articles are available on a custom printing basis at reasonable prices in quantities of 500 or more. For an exact quote, contact Art Lehmann, Cahners Reprint Service, Cahners Plaza, 1350 E. Touhy Ave., Box 5080, Des Plaines, IL 60018. Phone (312)635-8800.

CIRCLE NO. 3 ON INQUIRY CARD

THERE'S A LOT OF POTENTIAL LOCKED INSIDE EVERY MICROVAX II.

AND EMULEX HAS ALL THE KEYS.

Our full line of high performance storage and communications products uses advanced VLSI technology to unlock the power of DEC's new MicroVAX II.



THE KEY TO MICRO PERIPHERALS. The QD01 disk controller provides transparent emulation of Mass Storage Control Protocol while handling two ST506 drives with 2MB peak Q-bus transfer rate. Or use our QT12 tape controller, with QIC-02 interface, for low-cost 1/4" cartridge backup.



THE KEY TO COMMUNICATIONS. Emulex's CS02 multiplexer doubles line capacity, putting 16 async lines in the space DEC uses for eight. It runs at up to 38.4 K baud per line and is RS-423 and RS-232C compatible.

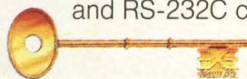

THE KEY TO LARGE PERIPHERALS. Our MSCP-emulating disk controller, the SC03/MS, interfaces to a variety of industry standard, high capacity SMD drives.

Emulex's TC02, TC03 and TC05 controllers—fully compatible with DEC TS drivers—cover your tape backup needs. From 1/4" and 1/2" streamers or conventional start/stop units to high performance 6250 GCR drives, they offer a superb range of capabilities.

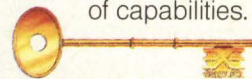

THE KEY TO SCSI-BASED MICRO PRODUCTS. The UC03 host adapter puts SCSI power in the MicroVAX II while simultaneously supporting multiple peripherals.

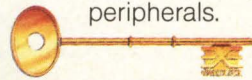

THE KEY TO PACKAGED SUBSYSTEMS. The Decathlon accommodates up to three 5 1/4" peripherals, including a combination of Winchester drives from 36-110MB (formatted) and 1/4" tape streamers to 60MB. Emulex's Medley combines storage and backup in a two-peripheral package with disk capacity to 110MB and 1/4" streamer to 70MB.

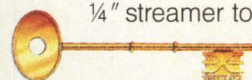

EMULEX. YOUR KEY RESOURCE. Emulex's broad product line unlocks the power of MicroVAX II, high-end LSI-11, Micro PDP-11, PDP-11 and VAX systems.

For product or sales information, call toll free 1-800-EMULEX3. In California, call (714) 662-5600. Or write: Emulex Corporation, 3545 Harbor Blvd., P.O. Box 6725, Costa Mesa, CA 92626.



The genuine alternative.

U.S. Regional Offices: Anaheim, CA (714) 385-1685; Schaumburg, IL (312) 490-0050; Roswell, GA (404) 587-3610; Nashua, NH (603) 882-6269. **International Offices:** Australia, Eastwood, N.S.W. (02) 858-4833; Canada, Mississauga, Ontario (416) 673-1211; France, Montrouge (1)735-7070; United Kingdom, Bracknell, Berkshire (344) 484234; West Germany, Munich (089) 304051.

*DEC, Q-bus, MicroVAX II, MicroVMS, VAX, LSI-11, PDP-11 and Micro PDP-11 are trademarks of Digital Equipment Corporation.

Most products shown are stocked nationally by Hamilton/Avnet, Kierulff Electronics and MTI Systems Corp.

CIRCLE NO. 4 ON INQUIRY CARD



Introducing the HP 9000 Series 300

The computer that

Starting right now, HP is going to change your thinking on the ways that computers can change. Because now, there's a computer system so easy-to-configure that it meets today's application requirements quickly and cost-effectively, and so modular and expandable that it embraces future application needs as well. Whatever the job at hand — advanced CAD and measurement automation, or word processing, spread sheets, and database management — the new HP 9000 Series 300 is equal to the challenge.

Your pick of processing power.

The Series 300 offers you the appropriate processing power for the job, running your choice of two Motorola microprocessors: the 68010 16/32 bit and the 68020 32 bit. You can start with the 68010 and easily upgrade to the 68020 when more processing power is required. Just as important, you have complete object code compatibility across the product line. So when you change processors, there's no need to recompile.

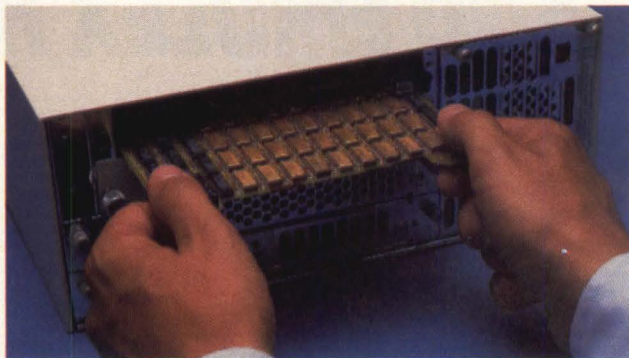

Changing CPUs in the HP 9000 Series 300 is a snap. You simply plug in a new card set and, with object code compatibility, you shift from a 68010 running at 10 MHz to a 68020 running at 16.6 MHz.

Adding peripherals is easy.

The Series 300 has the built-in interfaces to handle HP's large, fully compatible family of peripherals. There are many compatible monitors of varying resolution, too, so you can go from 12-inch monochromatic display all the way to high-speed, high-resolution color graphics.



UNIXTM operating system is a trademark of AT&T Bell Laboratories.
EthernetTM is a trademark of Xerox Corporation.

loves changes

In addition, there are a number of HP peripherals for you to choose from: input and mass storage devices, plotters, printers, and more.

Productive programming language options.

You also have a complete set of programming language tools to work with, to help you better meet the needs of your application. For instance, the Series 300 runs HP BASIC, as well as HP-UX — HP's robust version of AT&T's System V UNIX™ operating system. And HP-UX supports industry standard programming languages, too — FORTRAN 77, Pascal, and C.

Link entire systems, not just users.

The Series 300 is designed to be linked with other systems. Your initial application may call for a simple, single-user system. But the Series 300 has what it takes to grow into a sophisticated 100-node LAN based on IEEE 802.3 or Ethernet™. With LAN, the Series 300 can share data with the Series 200 and 500 computers in the HP 9000 family, plus the popular HP 1000 and 3000 family.

Consistent HP quality.

With the HP Series 300, you can count on cost of maintenance below 4 percent, the result of exceptional HP product quality, uniformly maintained with exacting tests in temperature, shock, humidity, altitude, and many others. Couple this with our complete service and support package and you have still more reasons to go with HP.

Call us today!

Choose the system that will change to meet the application requirements of you, your users, and your customers today and tomorrow. Call your local HP sales office listed in the white pages. Or call 1-800-522-FAST (in Colorado, 223-9717 collect) for the number of the sales office nearest you.

Now, get data on-line, 24 hours a day!

For immediate information, use your computer and modem and dial 1-800-367-7646 (1200 baud, 7 bits even parity, 1 stop bit). In Colorado call 1-800-523-1724.



DS15514

CIRCLE NO. 5 ON INQUIRY CARD

27mW and you're ready to roll.

27 milliwatts. That's all it takes for standby mode on our FD-35 Series 3.5 inch floppy disk drives with the Power Saver option. And, in operation, they consume a mere 1.72 watts average at read/write, and 2.90 watts average at seek. These just happen to be the lowest numbers for any 3.5 inch drive.

This remarkable feat is made possible by the use of new custom LSI chips with CMOS technology for more efficient control over all the drive functions.

For added reliability and accuracy we shortened the gap between the band actuator and the head and included a more precise head position mechanism. This means stable reading and writing, even at high track densities.

And, as if all that weren't enough, we've thrown in special aluminum RF shielding to keep out noise pollution.

With the growing need for more portable systems, 27 milliwatts is a load anybody can carry.

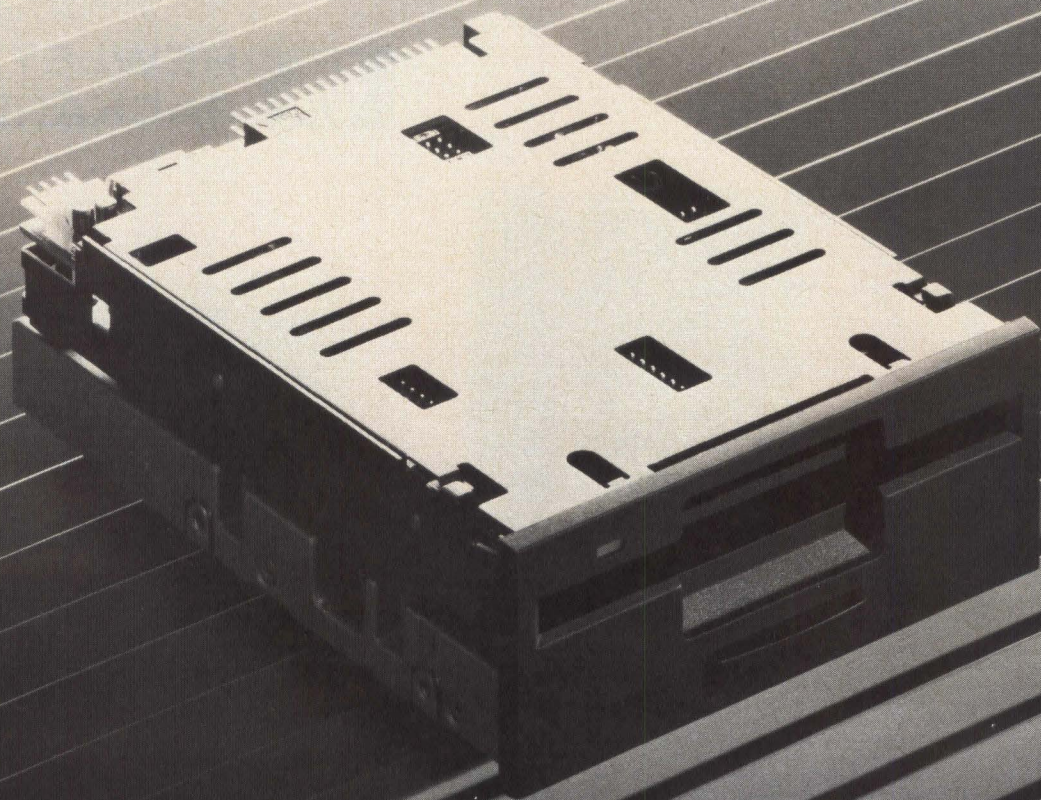

Built To Fanatical Standards. **TEAC**

INSTRUMENTATION AND COMPUTER PRODUCTS DIVISION, 7733 TELEGRAPH ROAD, MONTEBELLO, CA 90640

East (617) 475-7311 South/Midwest (312) 351-9124 Rocky Mountain (602) 242-4025 (303) 337-6329 (801) 532-2111

Northwest (408) 727-1427 Southern California (213) 726-0303

© 1985

CIRCLE NO. 6 ON INQUIRY CARD

Portable Tape Backup

FOR PC/XT/AT & COMPATIBLES

\$525

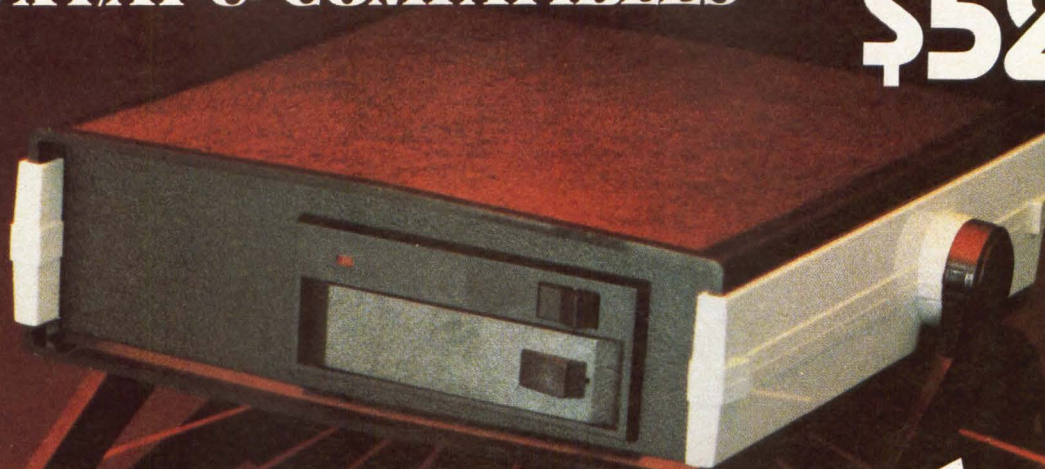

**NO HEAT
OR
SOFTWARE
PROBLEMS**

as found with
our competitors

IT'S MORE THAN A TAPE BACKUP!

One **MT10P** Portable Tape Backup is all your company needs. Simply disconnect the MT10P from the external floppy port of one IBM PC and connect it to the external floppy port of another . . . then "BACKUP." And even more incredible, the **MT10P** acts like a **FLOPPY** with the capacity of a **HARD DISK**. That's right! The **MT10P** can backup and retrieve "SPECIAL FILES." It acts like a "D" "Floppy Drive" with 10 meg per reel storage capacity. Be safe and backup with the incredible **MT10P**.

PORTABLE



DESK TOP MODEL

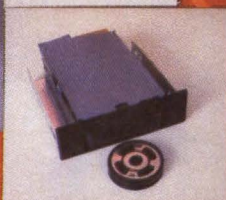

INTERNAL UNIT



ORDER LINE **800-228-0891**
305-677-8333



1 YEAR WARRANTY, 30 DAY MONEY BACK GUARANTEE ON ALL OUR PRODUCTS



Micro Design International Inc.

6566 University Boulevard, Winter Park, Florida 32792 (305) 677-8333 TELEX 332559 MDII ORL UD

IBM is a Registered Trademark

CIRCLE NO. 7 ON INQUIRY CARD

SOFTWARE BY ATLANTIS RESEARCH, INC.

RODIME

We're producing
thousands
in your size

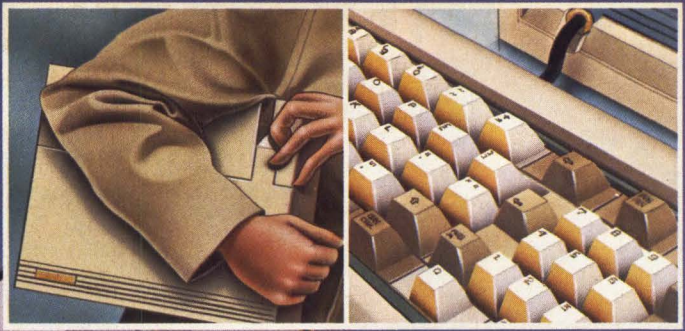

Rodime's design and production prowess in Winchester gives you the best of both worlds—5 1/4" or 3 1/2"! We have both out there performing dependably day in and day out, in everything from desktops to portables.

Our third generation 5 1/4" 200E Series drives are the lowest priced medium capacity Winchester on the

market—solidly proven by four years in the field.

They offer unformatted capacities from 13.33 to 53.34 megabytes.

Our 3 1/2" 350 Series drives are the acknowledged standard in this fast-emerging format. We're 100,000 drives ahead of the field, and currently shipping tens

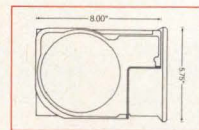
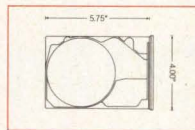

of thousands a month.

They can be configured to fit right into a full- or half-height 5 1/4" slot—picking up lots of memory and shock protection while substantially cutting power and heat. Phone or write for our 200E and/or 350 Series data sheets and brochure.

RODIME

901 Broken Sound Parkway, N.W., Boca Raton, FL 33431 • 305-994-6200
East: Atlanta, GA 404-980-9622 • Central: Austin, TX 512-453-5135
West: Mission Viejo, CA 714-770-3085 • Northern California: San Jose, CA 408-241-7200

CIRCLE NO. 8 ON INQUIRY CARD

EDITORIAL



LOOK AT THE JAPANESE FROM THE CORNER OF YOUR EYE

There are stars that are so faint you can see them only out of the corner of your eye. When you look straight at one, it vanishes. Look at a piece of space beside the star, and it reappears. There is a physiological explanation for the phenomenon: We have more rods—the cells we use for light perception—at the periphery of our retinas. So, we see light better out of the corner of our eye.

It would be better for us if we looked at the Japanese out of the corner of our eye, too. The Japanese don't give off much light. On purpose. They believe in putting their light under a bushel. On a recent trip to Japan, I tried to look at the people out of the corner of my eye. And I think I may have figured something out.

More than anything else, the Japanese believe in control—of themselves, of their total environment. Example, street scene: we American computer people are in a bus stuck in a massive grid lock in Tokyo. Suddenly, just across the street, a woman leaps from her car, loudly berates her husband for being so stupid as to get stuck in traffic and flounces off. Our Japanese guide and the driver look at this scene in open-mouthed horror. Finally, the guide, surprise still in her voice, says, "It is unusual for a Japanese to make such a scene. She must be a Japanese-American."

She is not trying to be funny. To the Japanese, control is what sets them off from the rest of the world—from Americans in particular.

But there's a catch. The Japanese practice what psychologist Fred Rothman of Tufts University calls secondary control. Primary control is what John Wayne did to the Indians. Secondary control is what the Indians did with nature. It's going with the flow.

For example, Americans control their home

market against imports directly, like John Wayne would, with tariffs, restrictions, agreements, rules. The Japanese do it indirectly by making distribution so complicated that no foreigner can figure it out.

The flap over trade restrictions with Japan is not an argument over controls. Nobody thinks Japan should surrender control of its borders. The argument is over the kind of controls her trading partners want her to use. We want Japan to use direct controls because we understand them and know how to live with them. We want Japan to drop indirect controls. They drive us crazy.

Do you see the problem? We're not asking the Japanese just to let in more imports. We're asking them to change their entire way of thinking about the business of imports. We're asking them to change something with roots deep in their souls.

Of course, we'll keep pushing and the Japanese will keep resisting, passively, with a smile, because that's the nature of secondary control. Nothing too bad will happen. There won't be a war. Neither side will break off diplomatic relations. The Japanese need the West, and we need the Japanese.

But you can count on this: It's going to continue to be much, much, much easier for you and your companies to buy computers and peripherals in Japan than it will be to sell them there. The Japanese trade imbalance—like death, taxes, communism and the Middle East—will not disappear in our lifetimes.

A handwritten signature in black ink that reads "James F. Donohue".

James F. Donohue
Managing Editor

When you need more hands on DEC, we'll be there.

Now Qume offers a full line of QVT™ ANSI terminals to help you expand your DEC system without going overboard on costs.

Qume's new QVT 201™ ANSI terminal is the only low-cost terminal that provides 100% VT 100 emulation and VT 220 software compatibility. Our new QVT 202™ ANSI terminal has 100% VT 220 emulation with better ergonomics than the VT 220 itself. And our QVT 311GX™ monochrome graphics terminal offers high quality, bit-mapped graphics that are fully compatible with both the VT 125 and TEK 4010/4014, plus full ANSI X3.64 text editing capabilities.

Every QVT terminal sets a new standard for reliability: 25,000 hours without a single repair, more than

twice the industry average. And because Qume is an ITT company, you know we'll be there to lend a hand in the years ahead.

For more information about Qume's full line of alphanumeric and graphics terminals—or our full line of daisywheel printers, printer supplies, and disk drives—call 800-223-2479. Or write Qume Corporation, 2350 Qume Drive, San Jose, CA 95131.



QVT 201™
Low-cost ANSI

311 GX™
Monochrome graphics

QVT 202™
VT 220 emulation

Qume
A Subsidiary of **ITT**

© 1985 Qume Corporation.

Tektronix 4010 and 4014 are registered trademarks of Tektronix Inc. VT 100 and VT 125 are registered trademarks of Digital Equipment Corporation. DEC and VT 220 are trademarks of Digital Equipment Corporation. ANSI is designed to American National Standards Institute, Inc., ANSI X3.64-1979 guidelines.

CIRCLE NO. 9 ON INQUIRY CARD



MOTOROLA

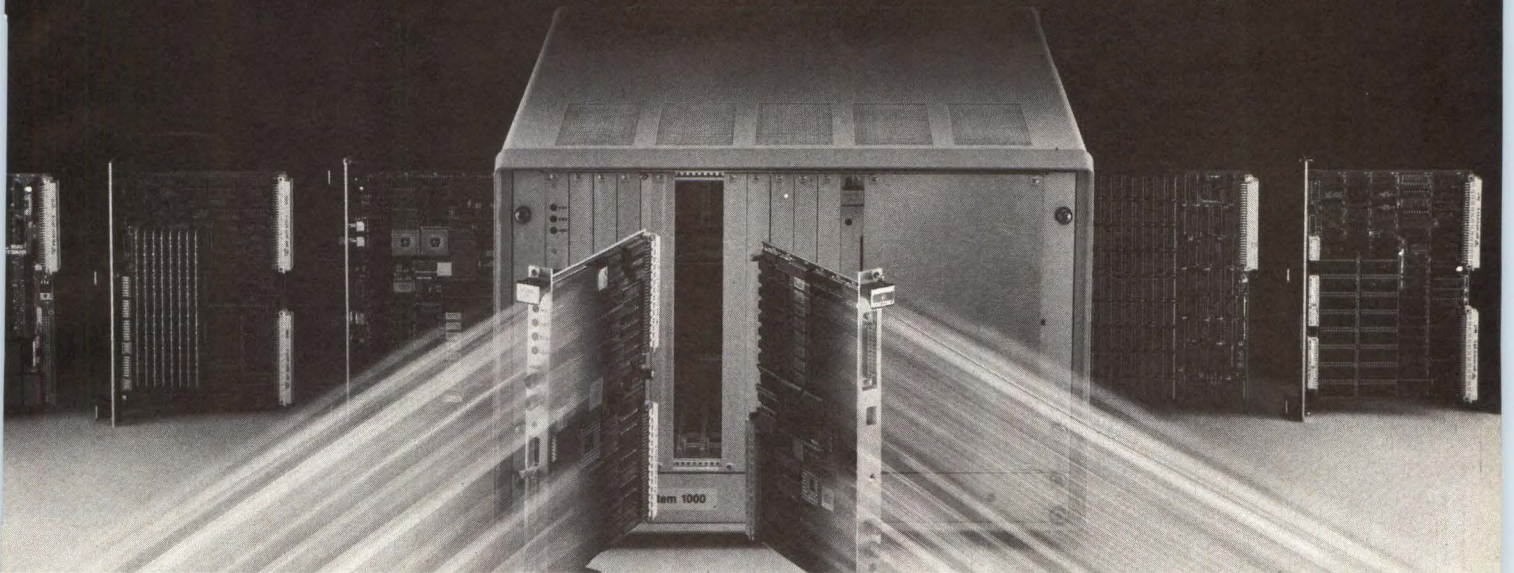

VME flexibility costs less.

Supercharge your VMEsystem integration with M68000-based VMEbus boards now available in convenient "core" configurations.

Why choose between overloaded OEM boxes laden with costly extra features which have no place in your end application?

A better idea: start with one of the smart new "core" VMEsystem packages in our VMEsystem 1000 Family. You get the basic MC68010 or MC68020 processing engine, with mass storage unit, in a pre-configured, tested, ready-to-go compact chassis that is convertible for either desktop or 19" rackmount usage. Back up the hardware with your choice of a full-featured VERSAdos™ real-time OS or the SYSTEM V/68 Operating System derived from UNIX™ System V.

Expand and customize its capabilities with one or more communications, graphics, or industrial I/O boards from our broad family of VMEbus compatible products. Then power up and begin immediately to develop your industrial automation, communications, CAD/CAE, or other high-performance end application. With no time wasted configuring your "core" system.

Your flexibility doesn't end with Motorola as you customize a board set to your target application. When you select VMEsystem architecture, you're immediately backed up by over 200 VME product vendors worldwide, offering more than 1000 compatible products. They're all in the new VMEbus Compatible

Product Directory published by the VMEbus International Trade Association. With VME you get totally open architecture without proprietary constraints.

With Motorola you get the world leader in VME product design, production, and support. You'll win with the only here-and-now bus of the future that allows smooth growth as the technology improves.

One-on-one design-in help.

For information on all the latest VME-system hardware and software products, get an engineer-to-engineer update.

From anywhere in the U.S. or Canada, call toll-free any weekday, 8:00 a.m. to 4:30 p.m., MST. If the call won't suffice, we'll have a local applications engineer contact you face-to-face.

For a vest-pocket catalog of Motorola's broad line of VMEsystem hardware and software products, contact Motorola Semiconductor Products, Inc., P.O. Box 20912, Phoenix, AZ 85036. Or use the coupon below.

We're
on your
design-in
team.

1-800-521-6274



MOTOROLA



To: Motorola Semiconductor Products, Inc.
P.O. Box 20912, Phoenix, AZ 85036

260MMS120085

Please send me Motorola's VMEsystem Mini Catalog.

Name _____

Title _____

Company _____

Address _____

City _____ State _____ Zip _____

Call me (_____) _____

UNIX is a trademark of AT&T Bell Laboratories. VMEmodule, VERSAdos and SYSTEM V/68 are trademarks of Motorola, Inc.

SCSI
gets real.



Finally, a single-chip controller that makes SCSI a standard worth standardizing on.

A REAL SOLUTION

Introducing the WD33C93, our remarkable new SCSI controller that's a genuine

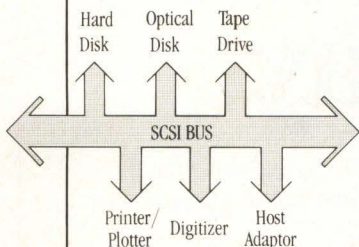

single-chip solution for designers of SCSI bus systems.

Now, whether you're designing hard disk systems, printers or plotters, optical or tape drives, digitizers, even host adaptors — or adding a SCSI bus in a host system — SCSI has never been more practical or easier to design in.

REAL ESTATE SAVINGS

We've taken a board full of devices and shrunk them into a single-chip solution. The WD33C93 has on-chip high current drivers, and supports both synchronous and asynchronous transfers. Or choose the WD33C92 if you prefer to add your own differential drivers.

Either way, four MB per second transfer rates, combination commands that minimize host intervention, and a *Translate Address* command that switches from logical to physical address make our SCSI controller the highest performance, space-saving single-chip solution you've been looking for.

single-chip solution for designers of SCSI bus systems.

Now, whether you're designing hard disk systems, printers or plotters, optical or tape drives, digitizers, even host adaptors — or adding a SCSI bus in a host system — SCSI has never been more practical or easier to design in.

single-chip solution for designers of SCSI bus systems.

REAL COMPATIBILITY

The WD33C92/3 is completely SCSI/ANSI X3T9.2 compatible. So you can standardize on it as either SCSI initiator or target, and be sure of total compatibility with any SCSI implementation on the market today including other SCSI devices, controllers and host adaptors.

REAL ECONOMY

We've got a proven history of putting complex standards into silicon, then driving those devices down the experience curve as fast as the market demands.

As complex as the WD33C92/3 is, it's a down-to-earth implementation that makes SCSI that much more attractive. Matter of fact, you can just about afford to design a WD33C92/3 into every system you build, as an extra competitive feature.

REALLY HERE.

Count on Western Digital to support your SCSI system requirements at both host and peripheral ends of the cable. The WD33C92/3 is here today, ready to sample, with

high volume production right around the corner. For details, contact the Western Digital sales office in your area.

100% ANSI X3T9.2
SCSI COMPATIBLE

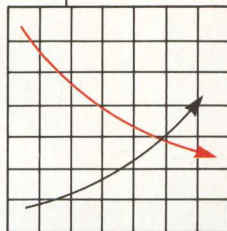

Our VLSI capabilities drive down cost as we drive up functionality.



Includes all necessary SCSI logic in a CMOS + 5V 44 pin chip carrier or 40 pin DIP.

WESTERN DIGITAL

C O R P O R A T I O N

2445 McCabe Way, Irvine, CA 92714

Western U. S. (714) 851-1221 Eastern U. S. (612) 835-1003

CIRCLE NO. 10 ON INQUIRY CARD

IBM's[®] Unix-[™]based system of the future is the CIES system of today.

IBM knew that someday even small businesses would catch on to the fact that PCs just aren't enough. Too little power. Too little memory.

IBM's solution: a UNIX-based multi-user system. Someday.

It's the same solution CIE Systems came up with over two years ago. And it's a solution we've been perfecting ever since.

The CIES 680 is not in the future. Not something you need now, but can't get. It's here. Today!

It's here with multi-user expandability of from one to 40 users, doing different jobs simultaneously.

It's here with up to 8 Megabytes of memory.

It's here with up to 1,300-plus Megabytes of hard disk, along with a floppy disk drive and streamer tape or half-inch tape drive backup.

It's here with all the power. All the memory. All the customer support. All the ready-to-run applications a business needs, including a complete general accounting program, word processing, electronic spreadsheet, even a complete medical practice program for physicians.

Not someday. Today. From CIE Systems, the ever-growing giant in supermicros backed by C.Itoh & Company Ltd., the fifth largest corporation in the world with over \$60 billion in annual sales.

For more information on the system you need today, not someday, just call or write.

CIE Systems, Inc., Computer Systems Division

A C.Itoh Electronics Company

2515 McCabe Way, P.O. Box 19628, Irvine, CA 92713-9628

or call (714) 660-1800. Call toll free (800) 437-2341.

In California call (800) 458-6279.

Telex: 655-438. TWX 910-595-2605.

In Europe: C.Itoh Electronics Co. LTD.,

Beacon House, 26-28 Worpole Road, Wimbledon SW19 4EE,

or call 01-946-4960, Telex: 895-5616.

™ CIES 680 is a Trademark of CIE Systems, Inc. ™ UNIX is a Trademark of Bell Laboratories.
® IBM is a Registered Trademark of International Business Machines Corp.
© 1984 CIE Systems, Inc.



C.ITOH

Computers

CIRCLE NO. 13 ON INQUIRY CARD

BREAKPOINTS

THE MAP DOESN'T STOP AT AUTOFACT

Manufacturing Automation Protocol (MAP) and Technical and Office Protocol (TOP) activity is gaining momentum following MAP/TOP's demonstration at November's Autofact '85 in Detroit. Starting in March, a host of companies will begin the implementation of OSI Net, connecting MAP/TOP systems at various sites in the United States and abroad to test protocols and exchange messages and files. Those companies include Amdahl Corp., Boeing Computer Services Co., Charles River Data Systems Inc., Digital Equipment Corp., General Motors Corp., Hewlett-Packard Co., IBM Corp., ICL Plc., NCR Comten Inc., Olivetti SpA, Software Decisions Inc., Tandem Computers Inc. and Wang Laboratories Inc. The project will develop testing techniques for MAP/TOP products and demonstrate network capability on AT&T Communications' Accunet or Wang's WangPac X.25 packet-switching links.—*Jesse Victor*

REED-SOLOMON ERROR-CORRECTION CHIP COULD SET NEW STANDARD

One by-product of the work being done on the enhanced small device interface for optical write-once, read-many disks may be a new standard for error-correction codes. A chip that implements a Reed-Solomon code providing better than 10^{12} performance from media, with a raw error rate as low as 10^4 , is expected shortly from a partnership of Data Systems Technology, Broomfield, Colo., and SMS/OMTI, Mountain View, Calif. The NG-8510 chip supports an interleave of three, each interleave with up to 669 bytes. Multiple chips can be ganged together to obtain more interleaves for block lengths greater than 2K bytes.—*Carl Warren*

AT&T PACT WITH VMARK PROMISES WIDER UNIX BASE

AT&T Information Systems has signed a reseller agreement with VMark Computer Inc., Natick, Mass., that ATTIS claims will increase the number of business-application software packages for UNIX-based computer systems from approximately 500 to potentially 3,000. Under the agreement, VMark will act as a master value-added reseller of ATTIS UNIX-based systems, including the UNIX PC and the 3B series. VMark will also supply UniVerse, an on-line database that supports applications developed for the PICK operating system. ATTIS says the agreement means PICK-based application software will now be able to run under UNIX.—*Stephen Shaw*

BUREAU OF STANDARDS EXAMINES OSI PROTOCOLS

The National Bureau of Standards (NBS) has established a research program to study the performance of open systems interconnection protocols. As part of the program, the NBS is compiling and maintaining a bibliography of papers and reports on the protocols. Researchers who submit relevant papers will be provided with an initial copy of the bibliography, along with periodic updates. Address research contributions to Kevin Mills, Manager of

Protocol Performance Laboratory, National Bureau of Standards, Room B217, Technology Building, Gaithersburg, Md. 20899.—*Bruce MacDonald*

GET READY FOR A NEW CAD/CAM GRAPHICS EXCHANGE STANDARD

If you're a computer aided design/computer aided manufacturing equipment vendor or user, take a look at what may be the successor to the ANSI-defined standard, Initial Graphics Exchange Specification. The International Standards Organization is now at work on STEP, the Standard for the Exchange of Product data, and ISO's Technical Committee, TC 184, has already published a 42-page initial-requirement definition of the standard. Jerry Weiff, the convenor of the STEP working group within TC 184, believes a draft international standard for STEP will be approved by the end of 1987, after which implementation by CAD/CAM system vendors can begin.—*Keith Jones*

CONTROL DATA'S HALF-HEIGHT WREN TAKES FLIGHT

Control Data Corp., Minneapolis, has begun shipping a half-height version of its Wren 5¼-inch drive to selected evaluation sites. The drive, dubbed the "Slim Envelope" Wren, has a formatted capacity of 51M bytes and a 28-msec access time. It uses an ST506/412 interface. Company officials were unwilling to disclose further details.—*Carl Warren*

UNDER-\$2,000 VMEBUS GRAPHICS BOARD USES HITACHI CHIP

Basu Inc., San Jose, Calif., has broken the \$2,000 barrier for VMEbus graphics boards. The low-end version of the company's newest boards, based on the Hitachi HD63484 CRT controller chip and loaded with 512K bytes of dual-ported memory, is \$1,795. A version with 2M bytes of memory lists for \$2,885. Basu is apparently one of the first board manufacturers to incorporate the Hitachi chip, which can be used to implement more than 120 firmware graphics commands.—*Mike Seither*

MICOM TIES PC/AT TO ETHERNET WITH PROCESSOR BOARD

Micom Systems Inc.'s NP600 Ethernet protocol processor board links IBM Corp.'s PC/AT to the Ethernet local area network. A single-board communications processor, the NP600 plugs into the PC/AT bus. When it is used with value-added software, says the Simi Valley, Calif., company, it allows PC/ATs to communicate with each other and with other devices on the network. Priced at \$1,150, the NP600 comes with 128K bytes of memory and 16K bytes of electrically programmable ROM, expandable to 512K bytes and 64K bytes, respectively.—*Lynn Haber*

DATA GENERAL UNVEILS FAMILY OF HARDWARE, SOFTWARE

In one of its broadest product announcements to date, Data General Corp., Westboro, Mass., recently introduced the three-model Eclipse MV/20000 32-bit superminicomputer; the low-cost Eclipse MV/2000 DC 32-bit, single-board unit; and the DS/7500 and DS/7700 series of engineering workstations, based on the company's Eclipse MV architecture. Accompanying the machines are a distributed operating system that uses Ethernet, AOS/DVS and TEO, a common user interface that combines technical and office applications in one system.—*Bruce MacDonald*

The fastest Perkin-Elmer compatible disk controller you can buy.

Console configuration supports future SMDs without PROM changes.

Reads and writes P-E's IDC and MSM packs.

Install any size SMD drive without OS/32 software patches.

High speed formatting.

World-wide maintenance available from P-E.

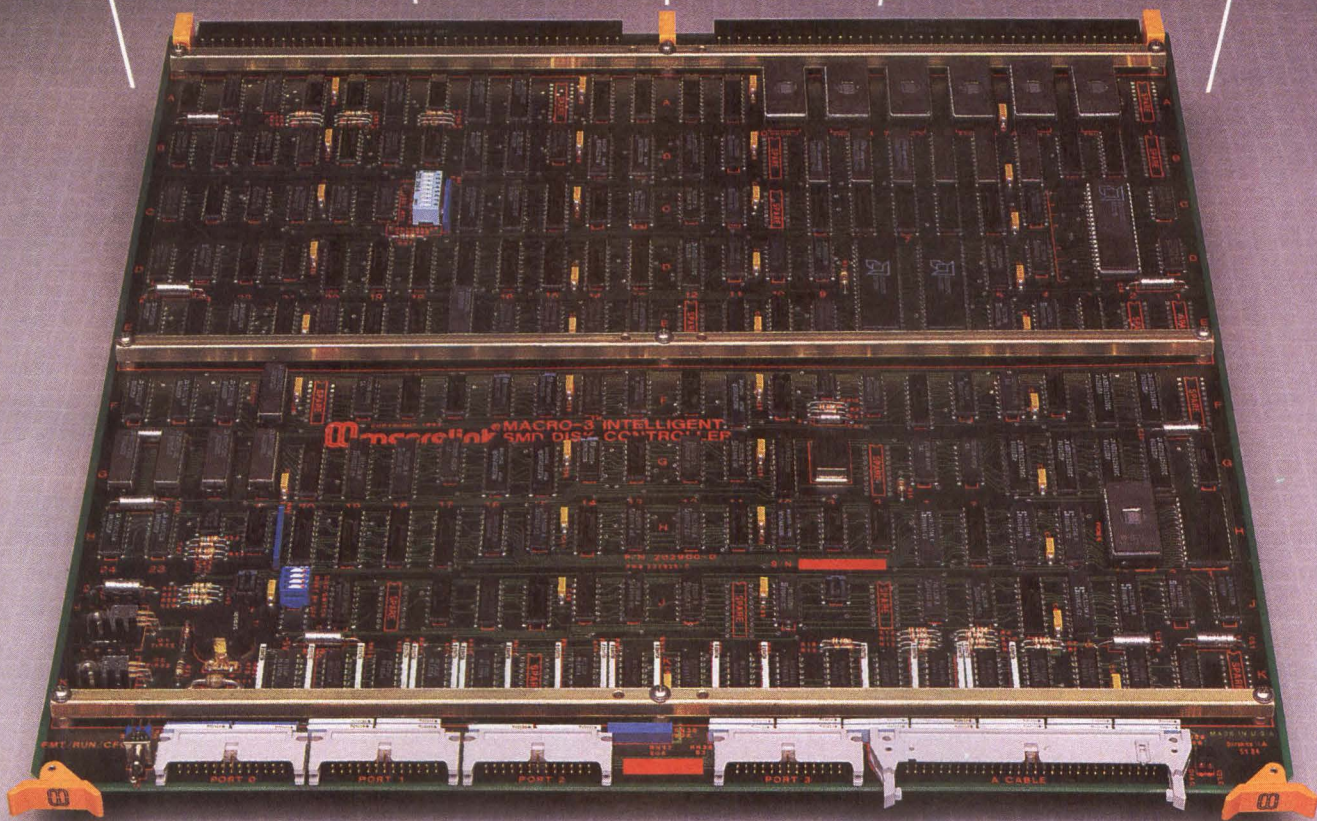

You're ready for the new generation of high performance SMD disk drives with the MACRO-3. High speed drives (over 2MB/Sec) are no problem. Only the MACRO-3 SMD controller offers full emulation of P-E disk systems, and supports advanced drives like the Eagle & CDC's FSD and XMD on any 3200 CPU. It can read

both IDC and MSM packs at the same time, a feature that P-E just can't match. And it's /XELOS/proven.

MACRO-3 is shipped from stock with installation manual, cables and a one year warranty. Of course it comes with the high reliability, tested performance and attractive pricing you'd expect from Macrolink. After all, we

invented the P-E emulating disk controller board.

Find out about the largest family of P-E compatibles going — including memory, COMM, tape and more. Call today for prices and details.

 **macrolink® Inc.**

Macrolink Inc. 1500 N. Kellogg Drive, Anaheim, California 92807 Phone (714) 777-8800 TWX 910-591-1671

XELOS and Perkin-Elmer are registered trademarks of Perkin-Elmer.

CIRCLE NO. 12 ON INQUIRY CARD

THE VT220 CONVERTIBLE

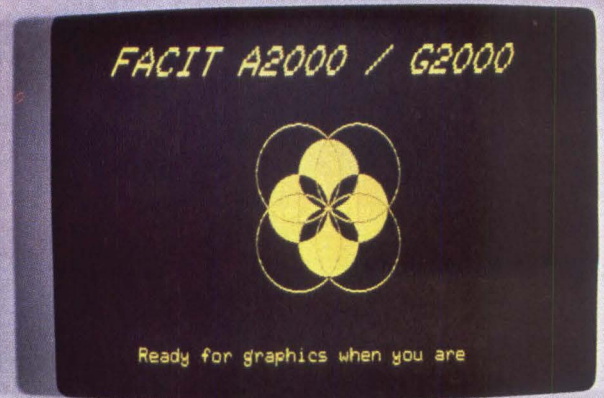

Ready
for graphics
when you are

The Facit A2000 Video Terminal is in all respects compatible with the VT220 concept.

But unlike a standard VT220 terminal, it can be easily converted into a very fast VT240 graphics terminal. Whenever you (and your software) are ready for it. Just plug a board into the terminal's cabinet. No extra box is required.

If you need the graphics immediately, you can have the A2000 already converted.

That's the version we call Facit G2000 – G for graphics.

Superfast Tektronix 4010 and DEC ReGIS graphics

The graphics board has two powerful on-board microprocessors which use highly advanced integral division for control of the

graphics. The result is dramatically shorter drawing times. Furthermore the terminals emulate both the Tektronix 4010 (Plot 10) and DEC ReGIS command sets.

Besides the graphics features, there are also several other reasons for looking closer at the A2000 and G2000. In addition to the functions of a standard VT220 terminal, they have expanded set-up menus, extra status lines, operator programmable function keys and a compose key that doubles as escape key.

Nothing will impress you more than a "hands on" demonstration of the Facit A2000 and G2000.

The terminals are ready.
Whenever you are.

VT and ReGIS are reg. trademarks of Digital Equipment.

FACIT

CIRCLE NO. 11 ON INQUIRY CARD

Head Office: Facit AB, S-17291 Sundbyberg, Sweden. Phone: (8) 764 3000. USA: Facit Inc. P.O. Box 334, Merrimack, NH 03054. Phone: (603) 424-8000

AUSTRALIA: EAI Electronics Associates Pty Ltd., 427-3322. AUSTRIA: Ericsson Information Systems GmbH, 0222-613 641. BELGIUM: Ericsson S.A., 02-243 82 11. CANADA: Facit Canada Inc., 416-821-9400. CYPRUS: LBM (Lillytos) Ltd 516 46 34. DENMARK: Facit A/S, 02-92 24 00. FINLAND: OY Facit, 90-420 21. FRANCE: Facit S.A., 1-4780 7117. GREAT BRITAIN: Facit 0634-40 17 21. GREECE: Computer Application Co. Ltd., 01-67197 22. HONGKONG: Gilman & Co. Ltd., 5-893 00 22. ICELAND: Gisli J. Johnsen HF, 354-64 12 22. INDIA: Forbes Forbes Campbell & Co. Ltd., 22-26 80 81. IRELAND: Ericsson Information Systems Ltd., 75 30 93. ITALY: Facit Data Products S.p.A., 039-63 63 31. JAPAN: Electrolux (Japan) Ltd., 03-479-3411. KOREA: K.D.C. Corporation, 723-8555/8236. THE NETHERLANDS: Ericsson Information Systems BV, 03480-709 11. NEW ZEALAND: Northrop Instruments and Systems, 501-801, 501-219. NORWAY: Ericsson Information Systems A/S, 02-35 58 20. PORTUGAL: Regisconta Sarl, 1-56 00 91. SINGAPORE: Far East Office Eqpts Pte Ltd., 745 82 88. SPAIN: Facit, 91-457 11 11. SWEDEN: Ericsson Information Systems Sverige AB, 08-28 28 60. SWITZERLAND: Ericsson Information Systems AG, 01-39197 11. WEST GERMANY: Ericsson Information Systems GmbH, 0211-61 090.

TECHFILES: A QUICK LOOK AT NEW PRODUCTS AND TECHNOLOGY

Digital Equipment Corp., Maynard, Mass., has deepened its commitment to the emerging compact-disk ROM (CD-ROM) market with two readers, five databases and an Application Development Service. The desktop readers for the IBM Corp. PC, PC/XT and PC/AT and DEC's Rainbow 100 are priced less than \$2,300. The databases, provided on DEC 600M-byte, 4.7-inch disks, include abstracts ranging from electrical engineering to environmental health and safety. The \$1,150 to \$1,195 annual subscriptions include quarterly updates and search-and-retrieval software. CD-ROM services available from the Application Development Service include database preparation, disk production, conversion programming and training.—*Jesse Victor*

Look for a reduced instruction set computer from **Point 4 Data Corp.** before the year-end. The superminicomputer from the Irvine, Calif., company will use a pipelined architecture, a 16-bit proprietary CPU and a 32-bit VME memory bus to achieve a maximum speed of 15 million instructions per second. An 84M-byte Winchester disk drive and 20M-byte streaming-tape drive will be standard on the eight- to 128-user machine. Prices range from \$42,000 to \$99,000.—*Mike Seither*

Keep your eye on the continuing battle between **Motorola Inc.** and **Intel Corp.**, both of which will introduce Manufacturing Automation Protocol (MAP) products that implement all seven layers of the MAP 2.1 protocol. Motorola's 10M-bit-per-second (bps), MC68020-based MVME372 Advanced Network Interface board has 640K bytes of RAM, runs MicroMAP software and utilizes the new MC68824 token bus controller chip. The VMEbus board, with an associated modem board, will be available in July 1986. Intel's new MAP-NET software/iSXM 554 MAP board combination for the Multibus, which also implements all seven MAP layers, will debut in April. Motorola has already gone head-to-head with Intel's iSXM 554 MAP board with a two-board set that, like the iSXM 554, implements the first four MAP layers. The Motorola MVME370SET comprises an Intel-80186-based controller board with VMEbus interface and 128K bytes of RAM, software in UNIX System V format and a 10M-bps modem board.—*Jesse Victor*

COMDEX/FALL '85 POST DATE: Look in January for production models of **Apricot Inc.'s** IBM Corp. PC/AT-compatible XEN. The Fremont, Calif., company's machine is based on the Intel Corp. 80286, has six I/O expansion slots, two 3½-inch flexible disk drives, 512K bytes of RAM, supports up to 16 users and is priced at \$3,500. Another \$1,000 buys a 20M-byte Winchester and 1M byte of RAM.—*Carl Warren*

Entering the laser printer business with a Hitachi America Ltd. engine is **Qume Corp.**, San Jose, Calif., with its 10 page-per-minute Laser 10. The machine holds up to 20 fonts in ROM; two fonts are resident. ROM cartridges are available to hold six fonts each, as are blank ROMs for downloading fonts from the host. With a claimed life of more than 300,000 pages, the Laser 10 also allows individual replacement of toner, developer and drum. The price is \$2,799 with a 128K-byte buffer.—*Mike Seither*

Zilog Inc. has befriended AT&T Technologies Systems' WE32100 32-bit microprocessor. The CPU serves as the backbone of Zilog's new System 8000/32 family of multiuser computers. The model 110, to be priced at about \$22,000, can handle up to 25 users and comes with 256M bytes of rigid disk storage. Model 130, a 58-user system with up to 1.3G bytes of storage, will be priced about \$30,000. Both will run on UNIX Version 2. Zilog, of Campbell, Calif., plans to ship the units in March or April.—*Mike Seither*

New high-capacity, 5¼-inch Winchester disk drives from **Priam Corp.**, San Jose, Calif., include the 172M-byte model 617 and the 234M-byte model 623. Both have access times of 18 msec and use the enhanced small device interface. Prices are \$1,495 and \$1,795, respectively, in OEM quantities of 2,500. Priam also introduced its model 725, a 254.9M-byte unit with the small computer systems interface. The eight-platter drive has an average access time of 20 msec. Pricing is not available.—*Mike Seither*

JDL Inc., Westlake Village, Calif., is pitting its color dot-matrix printer against plotters for a share of the engineering market. The company has modified its JDL-750 printer to produce C-sized drawings (17 inches by 22 inches). By adding drivers for AutoCAD and DASH, two widely used computer

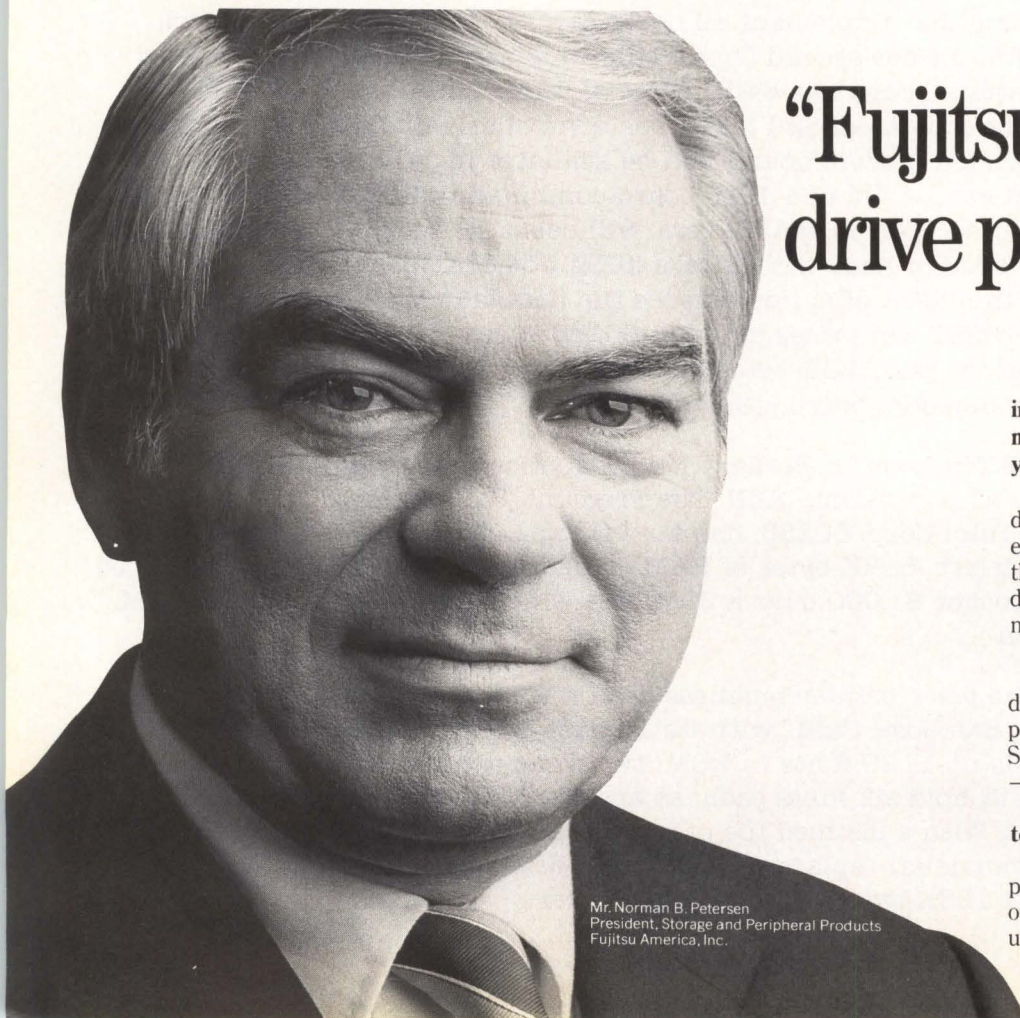

Mr. Norman B. Petersen
President, Storage and Peripheral Products
Fujitsu America, Inc.

"Fujitsu has done it drive performance,

Put these new 10½" and 8" Fujitsu drives into your existing design, and with only minor changes you'll significantly increase your system's performance and capacity.

With the introduction of the 10½" Eagle disk drive three years ago, Fujitsu established a new performance standard for the industry. The Eagle quickly became the disk drive against which others were measured. In both performance and quality.

And now we've done it again.

We've expanded both our 10½" and 8" disk drive lines with two new maximum-performance models. They set a high-speed SMD (HSMD) standard for data transfer —2.4 Megabytes per second!

And it's done using RLL encoding technology.

That means you get this new level of performance without sacrificing one bit of our world-proven reliability. These drives use the same basic head, media and

aided engineering programs, the JDL-750, priced at \$1,850, can print color circuit-board designs, schematics and mechanical drawings.—*Mike Seither*

NOTES FROM OVERSEAS: Early 1986 should see U.S. availability of two new ink-jet printers from **Siemens AG**, Munich. The PT 88S and PT 89S are said to offer faster drying ink, a quieter paper-movement mechanism and higher speeds than Siemens' PT 88 and PT 89, as well as near-letter-quality (NLQ) printing and subscript and superscript characters. Speed ranges from 200 characters per second (cps) to 340 cps in draft mode, and 66 cps to 114 cps in NLQ. End-user prices are about \$1,000 for the 80-column PT 88S and about \$1,200 for the 132-column PT 89S.—*Keith Jones*

Another European entrant to the U.S. computer field "sometime in 1986" will be **Thomson Semiconducteurs**, Grenoble, France, with its new range of VMEbus boards. Thomson is aiming for a 10 percent share of the worldwide VME board market by 1989—a market which the company thinks will be worth \$700 million annually by then. Look for four CPU boards based on Motorola Inc.'s MC68000 and MC68010 microprocessors, three memory boards and a variety of communications controllers, including one that supports X.25.—*Keith Jones*

again. We've set another standard in disk with a new, high-speed SMD interface."

actuator technology as our previous designs. Plus the same SMD interface.

Both models offer expanded storage capacity as well. The new M2361 Eagle

provides 689 Megabytes and the new M2333 8" drive has 336 Megabytes. And you can stack four of the 8" units in a standard 19" rack, providing 1.3 Gigabytes

of storage in the space of one 14" drive.

Both units offer fast access (18 and 20 milliseconds, respectively). Both use the same track capacity and controller. And both offer Fujitsu's field-proven quality, backed by a 20,000-hour MTBF specification.

And to top it all off, they offer you the lowest cost of ownership.

For more information or to arrange for evaluation units on the new 8" or Eagle disk drive, call (408) 946-8777 or write Fujitsu America, Inc., Storage Products Division, 3055 Orchard Drive, San Jose, CA 95134 Fujitsu Storage Products. Maximum Performance. Maximum Quality.



The M2361 10 1/2" Eagle Disk Drive—689 MB
MINI-MICRO SYSTEMS/December 1985



The M2333 8" Disk Drive—336 MB
CIRCLE NO. 14 ON INQUIRY CARD

FUJITSU AMERICA, INC.

FUJITSU

NCR

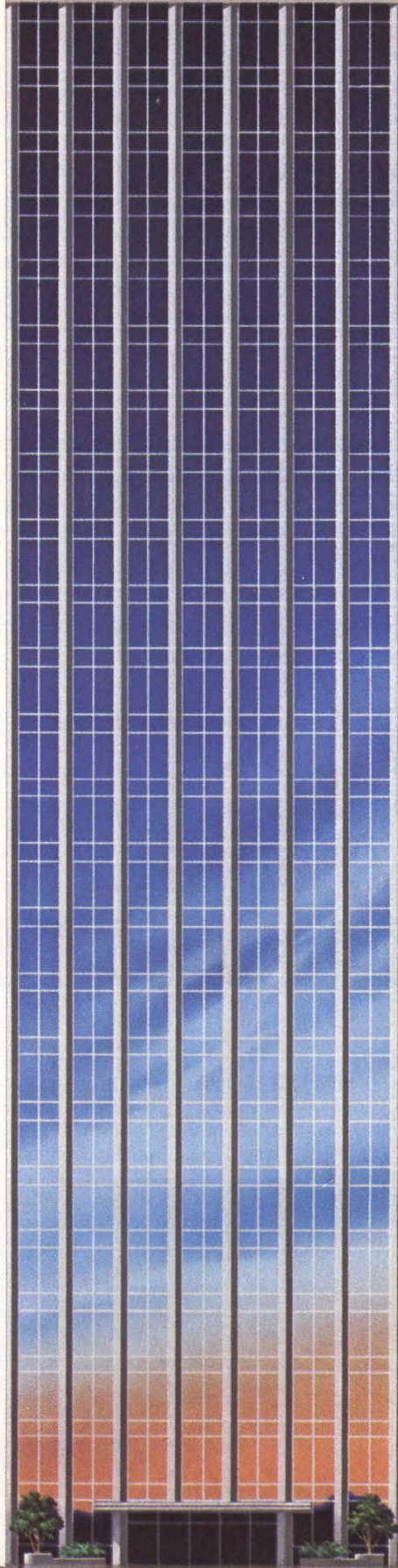

IF YOU LIKE WHAT'S INSIDE THE TOWER 32, YOU'LL LOVE WHAT'S BEHIND IT.

The NCR OEM Systems Division introduces the Tower® 32: Up to three times faster than the Tower XP. Memory capacity of up to 16MB, with an amazing 14MB per program. SCSI (Small Computer System Interface) providing up to 4GB of mass storage. Connectivity for up to 32 users and a host of industry standard interfaces. An NCR-enhanced UNIX* operating system. And more.

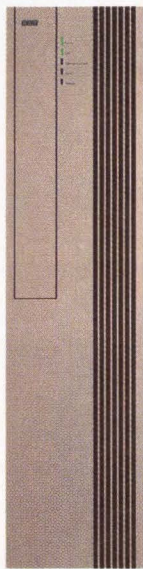

That's a lot to like. But NCR knows that high performance specs alone do not set an OEM's heart aflutter. You need to know that you're buying more than a hot box. You need to know you're buying a reliable system with proven software from a vendor you can count on, for years to come.

The NCR OEM Systems Division has more to offer OEMs right down the line, beginning with our comprehensive product line: Mini-Tower (1-8 users), Tower XP (1-16 users) and the new Tower 32 (1-32 users). So, no matter what size businesses you're selling into, or planning to sell into, NCR has a Tower product to fit your customers' exact needs.

And, Tower upgradeability means that as your customers grow, so can their Tower system. Painlessly. With minimum software investment, minimum support investment. Maximum return on your Tower investment.

Plus, every Tower you sell is backed by a \$4 billion corporation with a reputation for fanatical attention to quality and reliability. An installed base of thousands of Towers, and massive production capabilities to fill orders for thousands more. 7,000 service representatives in over 400 field service locations nationwide. And more.

The Towers: easy to configure, easy to sell, easy to install, easy to service. All of which makes the Tower family very easy to love.

**THE TOWERS.
BUILT FOR SYSTEMS BUILDERS
BY NIT-PICKING FANATICS.**



CIRCLE NO. 15 ON INQUIRY CARD

OEM Systems Division, NCR Corporation, U.S. Data Processing Group, USG-1, Dayton, OH 45479. Nationwide (800) CALL NCR.

Tower is a registered trademark of NCR Corp. UNIX is a trademark of AT&T. Specs subject to change. © 1985 NCR Corporation.

Our brain

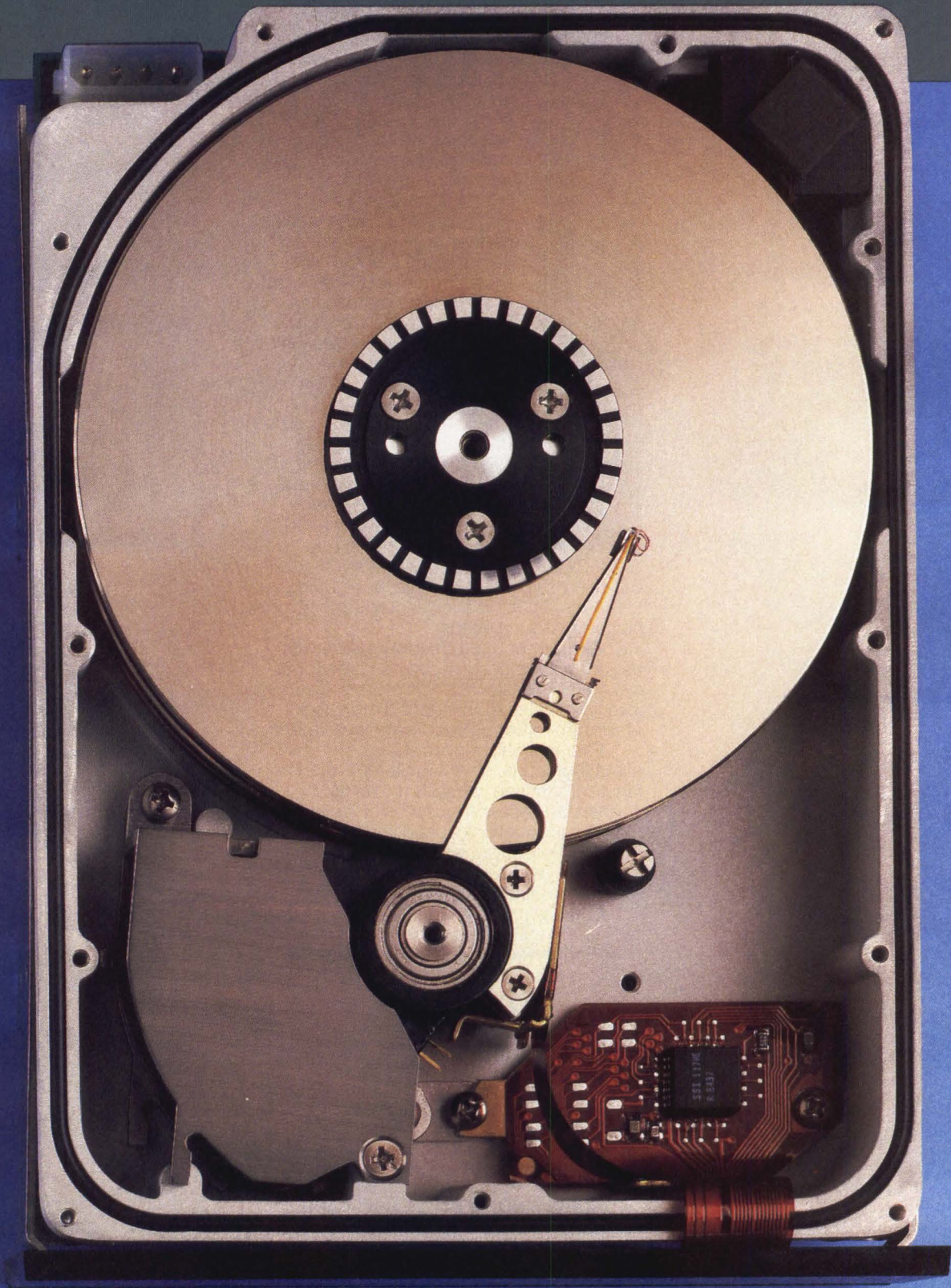

child.

Announcing the Q200™ intelligent disk drive.

The first half-high, 5¼-inch disk drive with the brains and the capacity (53 and 80MB, formatted) to outwit high costs now, and in generations of systems yet to come. And the first disk drive smart enough to step beyond simply enhancing peripheral functionality, to improving total system performance.

We combined the drive and controller as a fully functional mass storage unit to give you a number of advantages. Controller/drive interfacing problems are eliminated, and it takes a lot less time to test and integrate a single component.

The Q200 has its own media defect and error-handling capability, so it not only recognizes errors, but is clever enough to correct them itself. That means a major savings of time and work at your end, with no defect mapping to worry about.

With the SCSI interface, the Q200 breaks through the limits of existing drive technology, into a new way of thinking about system architecture as a whole. Your system no longer has to be designed and redesigned to accommodate a mixed bag of peripheral interfaces. System upgrades will no longer mean expensive hardware and software overhauls.

And like every Quantum drive that's come before it, our latest brain child was born to run longer, on less power, with fewer parts. This lean breeding not only delivers more in your system, but makes it possible for us to deliver the Q200 to you in very high volumes. At prices that will make this baby look very, very smart, indeed.

Please call us for more information.

Quantum Corporation, 1804 McCarthy Boulevard, Milpitas, CA 95035, (408) 262-1100. TWX 910-338-2203. Eastern Regional Sales Office: Salem, NH (603) 893-2672. Western Regional Sales Office: Santa Clara, CA (408) 980-8555. European Sales Office: Frankfurt, West Germany 069-666-6167. Quantum products are distributed in the United States and Canada by Arrow Electronics.

Quantum

**We say we'll solve your
networking problems,
speed performance and
get you to market faster.**



Call us on it.

At CMC, we offer more networking options than anyone, through TCP-IP or XNS[™] protocol software, terminal servers,

network monitors, Ethernet Node Processors, DDN connections, gateways, Ethernet video, baseband and broadband.

(805) 963-9471

CMC

High Performance Networking Solutions
Communication Machinery Corporation
1421 State Street
Santa Barbara, CA 93101
TWX: 910 334-3508

CIRCLE NO. 17 ON INQUIRY CARD

XNS is a trademark of
Xerox Corporation

Tektronix places its bets on computer-based testing

Mike Seither

Associate Western Editor

The time has come for a new generation of test and measurement equipment, according to Tektronix Inc. And what's the shape of things to come? "Computer-based instrumentation (CBI)," proclaims the Beaverton, Ore., company.

That's the name Tektronix has given to its new, closely coupled system of intelligent instrument boards that are built around the VMEbus. In an attempt to establish a new industry standard, Tektronix is encouraging other manufacturers to produce their own board-level instruments around the open architecture of CBI. Company officials claim that, compared with instrument clusters tied together with the IEEE-488 bus, CBI significantly cuts software development costs and increases performance at least tenfold.

The IEEE-488 bus, known also as the GPIB (general-purpose instrument bus) or the HPIB (Hewlett-Packard instrument bus, after Tektronix's prime competitor that pioneered the standard), is the dominant way to connect individual "rack-and-stack" instruments for use in design, test and service.

Prime Data, a San Jose, Calif., market research concern, estimates that last year's worldwide instrument sales of \$6.66 billion will nearly double by 1990. Tektronix is wagering that its new CBI architecture will grab a good part of that growth.

Arnold Frisch, manager of the Tektronix strategic unit that brought CBI to market, concedes that the IEEE-488 bus will still be the leading interface between computers and instruments

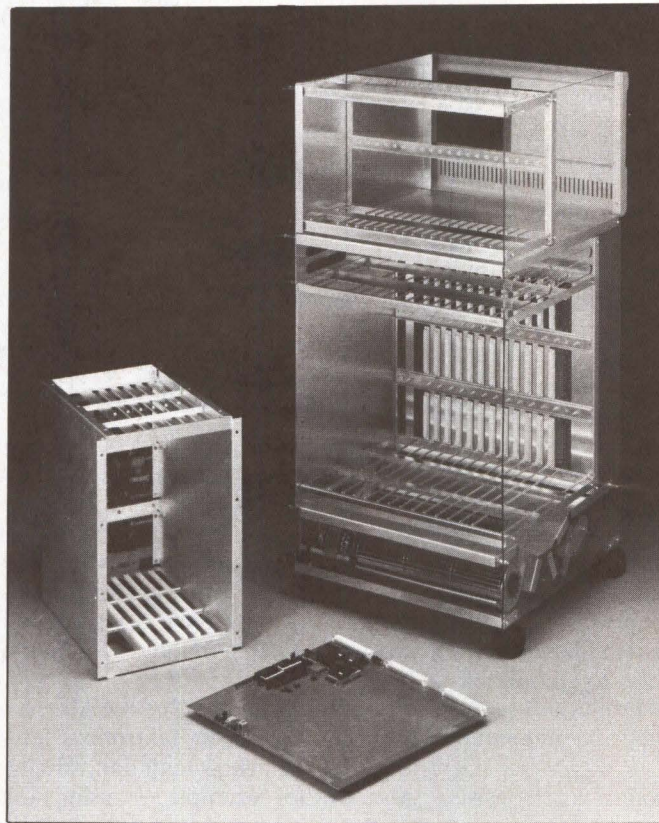

Tektronix hopes its new instruments on cards (foreground), which will be housed in VMEbus-based card cages (rear), will offer system builders an alternative to traditional IEEE-488 rack-and-stack instrumentation.

through the beginning of the next decade. "But alternatives [like CBI] will grow at the expense of GPIB in some markets," Frisch says.

Predicts military support

Tektronix expects CBI to receive immediate support from prime contractors building military test equipment. Frisch says that two major aviation test-equipment programs for the Air Force and Navy have gone to contractors who have opted for computer-based instrumentation instead of GPIB systems. The reason is dissatisfaction with GPIB on the part of the

Department of Defense, says Frisch. "It's at the point now where the cost of GPIB test-equipment support is larger than the cost of some of the weapon systems themselves," he says. "That's unacceptable."

What's the problem with GPIB? The complex programming that's required when a new instrument is added to the system, says Gary Gallager of Hughes Aircraft Co. Gallager is head of micro-processor programming at Hughes' ground systems group in Fullerton, Calif.

Under GPIB systems, similar instruments from a single manufacturer may

often have radically different command sets. That requires extensive low-level software to be written for each instrument, he says. In the life cycle of a major weapons system, Gallager adds, newer and better instruments replace older ones, adding to the programming headache. The result is that software can account for more than half the cost of a contract for an automated test-equipment system.

GPIB called sluggish

Another problem with GPIB, says Galen Wampler, president of Prime Data, is the relatively slow speed of the bus: The fastest GPIB can run is 1M byte per second. "In fact, a good implementation will run at about 300K bytes per second," says Wampler. The slowdown stems from overhead caused by so much protocol traffic on GPIB's 8-bit bus. By comparison, the 32-bit VMEbus can transfer data at 10M bytes per second. Says Wampler, "Bus speed is a very real issue for people who want to run instruments concurrently in real time."

Tektronix is offering two basic products in its CBI line. One, the Delta series, is a turnkey system to verify functions and timing in VLSI chips. That system, to be priced less than \$100,000, is targeted at department-level design engineers, to whom Tektronix believes the responsibility for testing application-specific integrated circuits is shifting.

A second CBI product line consists of off-the-shelf components, or what Tektronix calls "building blocks"—backplanes, cabinets, power supplies and card cages. Other standard hardware includes a single-board control processor based on the Motorola Inc. MC68010 CPU and various communications interfaces, such as Ethernet, RS232 and IEEE-488.

In all, the Tektronix CBI system can hold up to a dozen instrument cards. Each card has built-in intelligence by way of an on-board 68010 processor. Also available is a trigger time-base controller that uses a 50-MHz bus to sequence and synchronize tests among different instruments that require precise timing. Tektronix claims the trig-

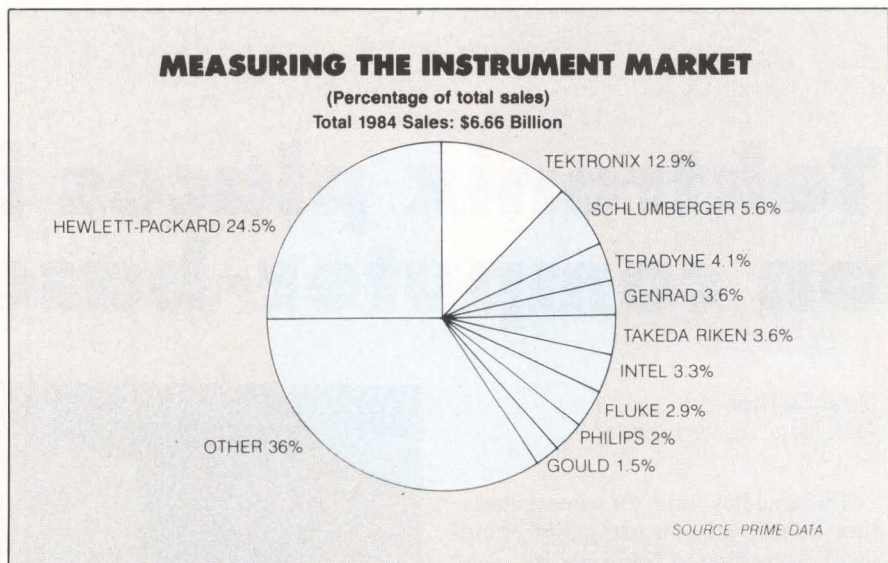

ger time-base controller, priced under \$5,000, can coordinate events within 100 picoseconds.

Three initial cards offered

Tektronix has made available for evaluation three instrument cards: a digitizer (\$20,000), an arbitrary waveform generator (\$15,000) and a pattern generator-word recognizer (\$25,000). All three come with the Delta series. Full production for the components is expected to begin in the second half of 1986.

So far, a number of OEMs have taken an interest in Tektronix's latest approach to instrumentation. Hughes Aircraft, for example, is using Tektronix's VMEbus components to build a portable analog system to test boards for the military. Says Bob Krogman, marketing manager for the program, "We chose Tek's VMEbus in order to reduce what would normally be a rack-and-stack system. That was the primary goal."

Krogman says Hughes also was attracted by the difference in speed between GPIB and the VMEbus and by Tektronix's commitment to an open architecture. "When other manufacturers begin making instruments for the same [VME]bus, that will give us flexibility that we really don't have with the IEEE-488," says Krogman.

One instrument manufacturer that

plans to ride Tektronix's coattails is Colorado Data Systems (CDS), which builds production test equipment. Louis Klahn, marketing manager for the Englewood, Colo., company, says, "From our point of view, we don't care whether our instruments run on the VMEbus, the Multibus or the Swahili bus. If the IEEE-488 performed up to its 1M bytes, it would be OK. The point is, a major player in this business has decided on a standard and opened up the architecture. No one will have to license this architecture like they had to in the early days of HPIB."

Klahn says his company is developing an optimized VMEbus interface under the Tektronix architecture that will allow CDS to attach its own set of instrumentation to the system.

Despite the praise Tektronix has received for its new approach to instrumentation, no one in the industry is yet ready to play taps for the IEEE-488. In fact, says Gallager of Hughes, an IEEE committee (P981) is developing a new software standard that defines a common protocol for message exchanges among different instruments on the bus. Gallager says that, although some committee members believe the future of GPIB is limited, the bus will be around for a while. "It's so embedded in test systems that I'd be surprised to see its demise within the next decade," Gallager says. □

Has binary compatibility come to UNIX?

Michael Tucker, Associate Editor

Some UNIX applications may be about to get a shot of binary compatibility. Certain experts are saying that UNIX ports to the Intel Corp. 32-bit 80286 and 80386 chips, and their use in the popular IBM Corp. PC/AT may rewrite the rules for UNIX.

The UNIX market has long suffered from the fact that not only is UNIX, itself, divided into competing variants but even those individual variants sometimes perform differently from processor to processor. Where, for example, software based on MS-DOS from Microsoft Corp., Bellevue, Wash., could generally be expected to run on any MS-DOS- or PC-DOS-compatible machine, UNIX lacked this "binary compatibility." An application designed to run under UNIX System V on a machine from one vendor might or might not (indeed, almost certainly wouldn't) work on another vendor's machine even though it too ran on UNIX System V.

That could now change, at least on desktop UNIX machines, because of the microprocessor chips from Intel of Santa Clara, Calif. Unlike similar chips, these have their memory management unit (MMU) located on the chip itself. "A computer designer would tell you that's not particularly smart," notes Charles Hickey, president of porting house Microport Systems, Soquel, Calif., "but for UNIX, it solved a particular problem. A [software application] developer can assume that MMU will never change. That means you can get binary compatibility. You could take a binary application off one 286-based machine, like an AT&T [Information Systems] 6300, and run it on another, say an IBM PC/AT."

Not everyone is so hopeful. Jim Isaak, director of product marketing for Charles River Data Systems, Cambridge, Mass., and chairman of the IEEE P10003 operating systems committee, strongly disagrees: "That's a

half-truth. The 286 has been no end of frustration to the UNIX community. It is simply nasty.

"Let's say we all agree to use it. The MMU affects you just a little bit. What does affect you a lot is the method you use to get into the operating system. The 386 doesn't limit the way you do that...so you could easily lose binary compatibility that way."

Still, the 80286 and 80386 are bound to have a lasting effect on what UNIX

is, and what it's used for, for the simple reason that they are the chips selected for the PC/AT, its compatibles and its most ambitious rival, the AT&T 6300 Plus. Douglas Michels, vice president of XENIX's second source, the Santa Cruz Organization, Santa Cruz, Calif., is confident enough of the chip to say, "My personal view is that the Intel-family XENIXes are going to dominate the UNIX world very fast. Clearly, in the one-to-eight-user market, you're going to see the 286 pretty well run the market. If you're an applications developer for the small multiuser market, and you're not writing XENIX applications, you're not going to be in business in a year." □

Fault-tolerant computing tries to get less expensive

Lynn Haber, Associate Editor

The image of fault-tolerant computing has fallen. The handful of start-up companies—which analysts say have been bankrolled by venture capitalists at \$150 million to \$250 million over the past few years—have largely failed in their promise of low-cost products. Still, the niche remains for continuous-processing systems for under \$100,000. Which companies are prepared to deliver the goods? According to industry analysts, such systems are most likely to come from the fault-tolerant computer manufacturing leaders, Tandem Computers Inc., Cupertino, Calif., and Stratus Computer Inc., Marlboro, Mass.

Peter Lowber, director of information systems with the market research company the Yankee Group, Boston, contends that opportunities for start-ups in low-end fault-tolerant systems are bleak. "Eighteen months ago the market environment for start-ups to build a low-cost, fault-tolerant machine had potential," says Lowber. "But, now, the credibility of these companies has been badly damaged."

Fault tolerance is a computer feature of paramount importance to the on-line transaction-processing market,

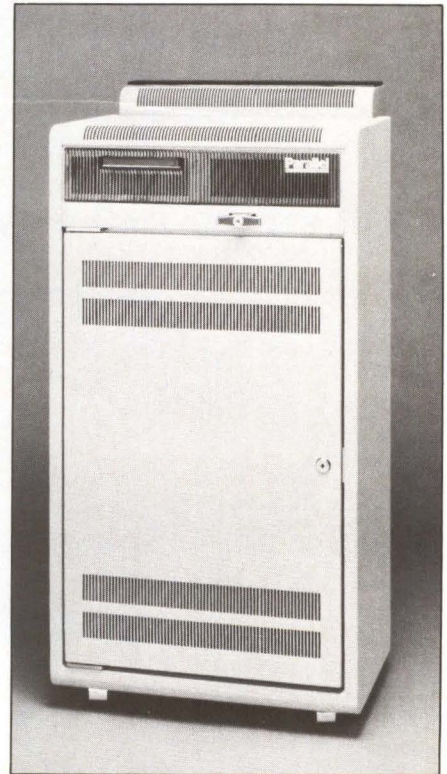

Parallel's 300XR general-purpose computer system was designed on a redundant architecture and is based on the standards of the UNIX operating system and the IEEE-796 Multibus.

whose customers include banks, airlines and brokerage houses. Here, computer downtime can mean million-dollar losses. In 1984, this market reached \$16.6 billion dollars and is projected to increase 30 percent annually, according to Lowber. While fault-tolerant systems only account for a fraction of those revenue dollars, a growing market remains for vendors who can bring fault tolerance or even "high-availability" (nearly total uptime) to smaller businesses.

These lower cost, fault-tolerant systems would meet the needs of the

branch office or distributed applications, or any businesses requiring up-to-date database information, such as hotels and mail-order houses.

Both Tandem and Stratus, whose systems usually begin at about \$200,000, recognize the need for lower cost systems. "If you walked into our laboratories today," says a spokesman from Stratus, "you'd see activity going on for low-end products. I'd say you'll probably see smaller fault-tolerant systems from both Stratus and Tandem in the near future."

When low-cost, industry-standard,

off-the-shelf computer components came about, they were expected to fuel the low-end of this market by allowing fault tolerance to be added as an inexpensive feature. But system developers ran into major problems involving attempts to rewrite UNIX—the chosen operating system—to accommodate fault tolerance, says Lowber. These UNIX implementations were supposed to have been a quick-fix answer for many users; significantly, though, Tandem and Stratus developed proprietary operating systems.

By 1985, says market analyst Sandra Gant of InfoCorp, Cupertino, Calif., lower hardware and technology costs meant fault-tolerance capabilities would no longer add significantly to the overall price of a computer. That, at least, was the idea. "Manufacturers could now use lower cost of ownership and the importance of uptime as an argument for selling such systems," she says.

But, development difficulties, product delays and cash shortages eventually jaded industry watchers and potential customers alike. A few start-ups—Auragen Systems Corp., Fair Lawn, N.J., and Synapse Computer Corp., Milpitas, Calif., for instance—closed up shop before opening.

The cost of Tandem and Stratus entry-level systems—the Nonstop series EXT model and the model FT 250, respectively—each cost over \$100,000. Only a few new systems, from other manufacturers, cost less. NoHalt Computers, Farmindale, N.Y., offers the Reliant II, a 50M-byte, dual-disk computer system with an entry-level price of \$30,000. According to Jerry Ottieri, vice president of sales for NoHalt, the Reliant II ties two processors together (expandable to eight pairs) and relies on redundant databases and power supplies.

In addition, Parallel Computers Inc., Santa Cruz, Calif., markets the 300XR, a fault-tolerant system featuring redundant architecture based on Motorola Inc.'s MC68010 micro-processor and the Berkeley UNIX Version 4.2 operating system. It is equipped with the IEEE-796 Multibus. Parallel's systems range in price from \$50,000 to \$100,000.

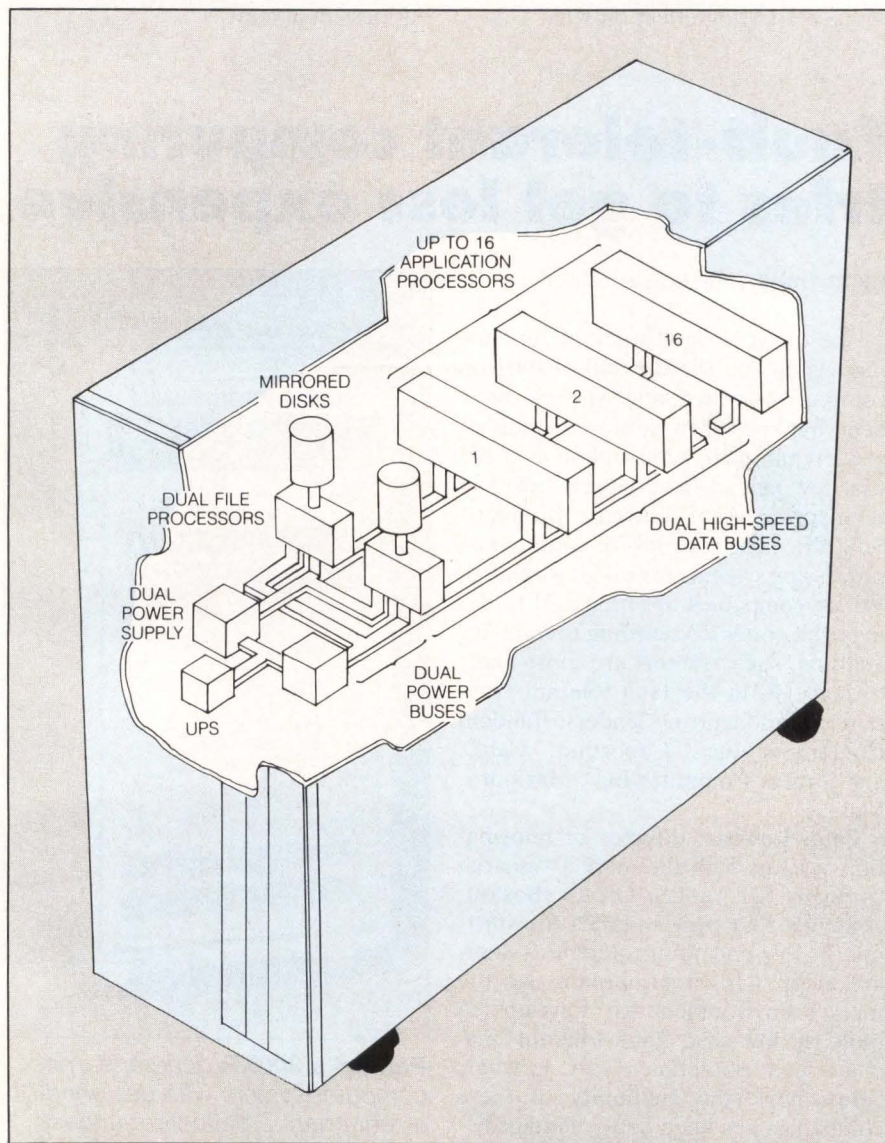

In NoHalt's Reliant II, fault tolerance is built in at the system level via redundant disks, file processors, data buses and power supplies. A special monitoring subsystem scans to detect faults.



We demo our Data PBX on-site. (They just send brochures.)

Since we introduced our first Data PBX two years ago we've been doing things that other vendors would like to do . . . but can't. Things like on-site demos, 30 day free trials and packing more data switching features into less space for less money than anyone else. Today over 100,000 terminals and computer ports are connected to over 500 Equinox Data PBX's.

We're a tough act to follow.

Our new DS-5 (shown above) gives you more of a good thing in an even smaller package. A fully featured Data PBX, the DS-5 is smaller than an IBM PC and provides keyboard controlled switching and port sharing for 120 async terminals and computer

ports at \$120 per line. It can be expanded to 1320 lines and is completely compatible with its bigger brother, the DS-15.

We're easy on your wires.

All Equinox products are designed for fast, easy installation using modular telephone wiring accessories and in most cases your existing wiring can be used.

Let's get together.

Whether you need to connect 50, 100 or 1000 terminals and computer ports together and are looking at Data PBX's, Port Selectors, or LAN's, we've got a switch for you. Don't just settle for brochures - see for yourself how easy data switching can be.

Call 1-800-Data PBX* for a no-hype demonstration.

Equinox Systems
12041 S.W. 144th Street
Miami, FL 33186-6108

*In Florida call
(305) 255-3500



EQUINOX
Systems

We Make The Right Connections

CIRCLE NO. 18 ON INQUIRY CARD

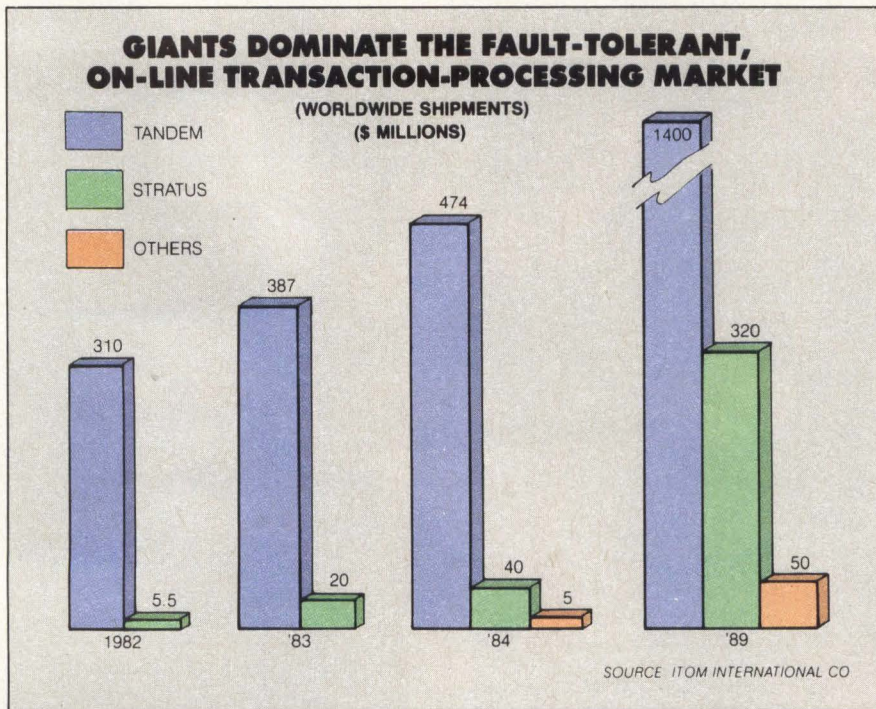

Originally, the low-end start-ups were out to beat Tandem and Stratus with lower priced, equal-performance machines. But, according to Omri Serlin, consultant and president of market research concern ITOM International, Los Altos, Calif., the Reliant II and 300XR, while respectable in their own right, simply do not match the functionality or performance of the more expensive Tandem and Stratus products—therefore posing no threat to them. Combined, NoHalt and Parallel have installed only 60 units.

Competition comes from above

For Tandem and Stratus, the greater threat comes from mainframe manufacturers such as IBM Corp. and Burroughs Corp. According to the Yankee Group's Lowber, two-thirds of the on-line transaction-processing market is dominated by IBM and he says their mainframe computers have developed a reputation for high reliability and uptime.

While traditional methods of achieving high computing availability have been through hardware (redundant components), high availability is also attainable via software. IBM, for example, will offer in the third quarter of 1986 the XRF (Extended Recovery

Facility), a Multiple Virtual Storage/Extended Architecture (MVS/XA) system and Systems Network Architecture enhancement. Basically, XRF enables users to rewrite or recover an application on-line, should a processor running IMS go down.

The viability of availability

A likely system configuration for businesses requiring high availability, then, might be a non-fault-tolerant mainframe running a database program, thereby serving as the backend to a low-cost, fault-tolerant front end.

Other computing schemes are also giving users high availability—for instance, the multiprocessor and multi-user technologies afforded by Digital Equipment Corp.'s clustering ability.

It is for this reason that industry analysts say low-end fault-tolerant system manufacturers will eventually be competing with multiuser microcomputer manufacturers. □

FCC reversal on AT&T separation rankles VARs

Stephen J. Shaw
Washington Editor

The Federal Communications Commission's recent decision to remove the requirement that AT&T Co. sell its computers, terminals and interconnection equipment through a separate subsidiary could mean long-term trouble for third-party dealers and value-added resellers. The decision allows AT&T's unregulated equipment arm, AT&T Information Systems, to be partially melded back into AT&T.

AT&T predictably welcomed the FCC decision, while both equipment and service competitors accused the FCC of caving in to pressure from AT&T. Among the most vociferous of the opponents was the North American Telecommunications Association (NATA) of Washington, a trade group of vendors of private branch exchanges and other network-interconnection equipment.

The decision reverses a 1980 ruling in which the FCC imposed on AT&T a "structural separation" requirement in what was known as the Computer II Inquiry. Its purpose was to prevent AT&T from subsidizing customer-premises equipment (CPE) with revenues from network services offered by AT&T Communications.

FCC issues four safeguards

In voiding the separation requirements, the FCC ordered AT&T to adopt certain non-structural safeguards to prevent abuses of AT&T's still-dominant position in the provision of long-distance network services. Specifically, the FCC ordered that AT&T provide its equipment competitors, six months in advance, with information on planned changes in the telephone network that would affect equipment interconnection; to submit an accounting plan, before final implementation of the order, demonstrating the lack of

It's not just that someone buys
a COMPAQ Computer every 62 seconds
of every business day...

It's why.

For three years now, COMPAQ® Computers have sold at the rate of nearly one per minute of each business day. That's made COMPAQ the fastest growing computer company in the world. Because when people take the time to learn about computers, they learn that COMPAQ Computers simply work better.

Our portable computers are built with innovations that surpass most desktop computers. Our rugged COMPAQ PORTABLE 286™ runs software 30% faster than the IBM® PC-AT™. And can come with an *internal* tape back-up system to protect your data—an exclusive in our portable computer.

Our desktop computers are packed with more advances. Our COMPAQ DESKPRO® Series runs faster than the IBM PC or IBM PC/XT™. The COMPAQ DESKPRO 286™ is even faster than the IBM PC-AT.

Our desktops store more. Add up to four *internal* storage devices, including a tape back-up.

In fact, all COMPAQ Computers are expandable *and* compatible. No compromises. That's why, of the nation's 1000 leading companies, more of them use COMPAQ Computers than any other brand, except one. And we're closing the gap.

For more information or the names of Authorized COMPAQ Dealers who can set up a hands-on evaluation, call 1-800-543-1300. Ask for Operator 270.
©1985 COMPAQ® Computer Corporation. All rights reserved.

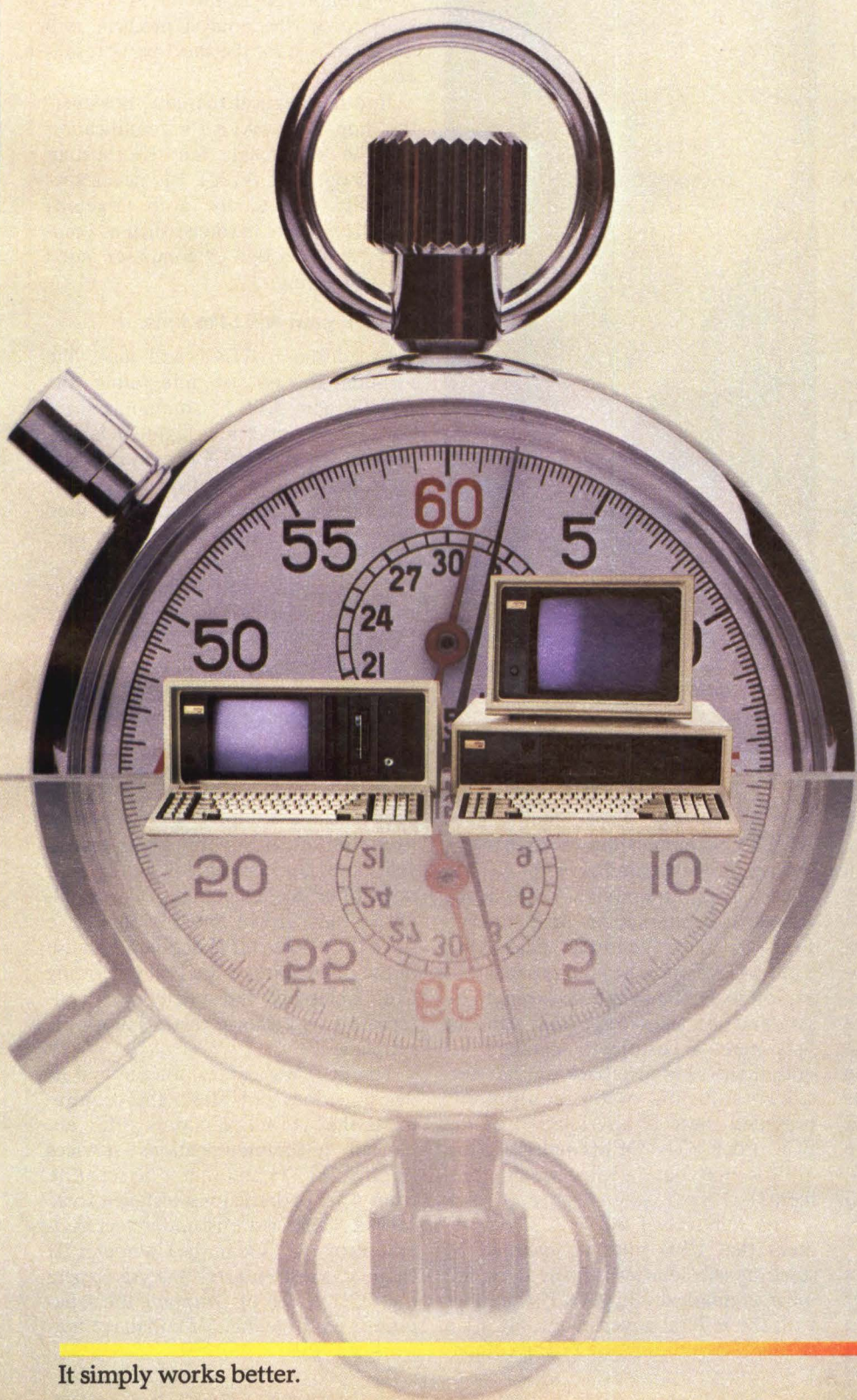

It simply works better.

COMPAQ®

any cross-subsidization between equipment and network-service offerings; to provide network service to competitors' customers equally with its own CPE customers; and, at a customer's request, to refrain from divulging any information on the customer's networking to ATTIS.

NATA termed the four non-structural safeguards "ambiguous, open-ended" and as having "more holes than substance." A NATA spokesman said the decision will allow AT&T to implement its own marketing plans before the public and the telecommunications industry have a chance to comment on the AT&T-designed accounting plan that will, supposedly, prevent cross-subsidization abuses. According to a staff attorney in the policy branch of the FCC, the AT&T accounting plan will be first subjected to a limited review by the commission. If the plan is found to be generally acceptable, AT&T will be allowed to proceed with joint marketing of equipment and services. But only after that initial review will the public have a chance to comment on AT&T's plan.

AT&T executive vice president Charles Marshall says the decision means better service for customers and urges that remaining restrictions on the provision of enhanced services be dropped. The decision, he adds, would enable AT&T to manage its costs more effectively, and lead ultimately to lower prices.

In a prepared statement, Marshall said AT&T will test a joint marketing arrangement. Ten integrated account teams will be formed by personnel from ATTIS and AT&T Communications to separately serve business customers. Each of the two organizations will manage five of the account teams. "We'll use this experience to plan the management of other large accounts by early 1986," he said. AT&T will also immediately consolidate its three marketing groups (two from ATTIS, one from AT&T Communications) that sell to the federal government into one organization.

The merging of AT&T's sales forces could also squeeze VARs and other third-party equipment vendors who have been selling ATTIS equipment in



Charles Marshall, AT&T executive vice president, says the FCC's latest decision will lead to lower prices for customers.

vertical markets. Large numbers of AT&T Communications sales personnel are already familiar with ATTIS' line of CPE equipment, notes Katie Klosterman, market research supervisor with Yates Ventures, Palo Alto, Calif. AT&T now has the go-ahead to exploit its communications strength by sending one sales force that can not only meet a customer's network requirements, but also back up that network solution with equipment, provided there is no violation of the FCC order. "The OEMs and VARs are a little nervous," Klosterman comments.

The removal of the FCC's requirement that CPE sales be handled by separate subsidiaries is likely to be felt most dramatically in AT&T's dealings with the federal government, always a strong segment for AT&T. The compa-

ny's efforts had been hampered by the need to maintain three sales teams, in addition to maintaining relationships with several VARs to meet specific government applications. A unified sales force, the analyst predicts, will mean trouble for the third-party resellers.

In other vertical markets, however, the impact of AT&T's reunification may be less keenly felt. Klosterman points out that AT&T has never successfully sold to (or even targeted) specific vertical markets, such as computer aided design or computer aided manufacturing.

AT&T's plan will take time

In addition, AT&T still faces the formidable task of integrating the ATTIS and AT&T Communications sales forces, until now highly independent. Although AT&T certainly has more personnel at its disposal now for integrated equipment and service sales, the transition will likely take some time, Klosterman says.

So, it seems, did formulating this ruling, for which AT&T petitioned the FCC in mid-1984. AT&T argued that the duplication of personnel and facilities was costing it more than \$1 billion per year. Removing the structural separation requirement, AT&T claimed, would enable the company to offer equipment and long-distance service as one package to meet its customers' needs more effectively. More than a year later, the commission has agreed, noting that the telecommunications industry has grown more competitive since the Computer II decision because of the divestiture of the Bell Operating Companies and the emergence of alternate long-distance carriers and CPE suppliers.

The FCC was careful to note that its decision does not affect the requirement that AT&T can only offer enhanced telecommunications services through ATTIS and that it be separate from AT&T's basic long-distance voice service. That issue is under reconsideration by the FCC in the Computer III Inquiry. Most industry analysts expect the FCC to end up dropping the separation requirements for enhanced network services. □

It's not just that the COMPAQ Portable is the best-selling portable computer in the world...



It's why.

The COMPAQ® Portable Personal Computer was destined to become a classic. It does more than most desktops because of some far-sighted engineering.

We knew that companies would want computers that could keep up with changing technology, so we created a modular portable with a design so innovative it's been patented. It's completely compatible with industry standards. And it has enough memory and expansion slots to accommodate networking, a modem, or a mouse.

Our portables will also accommodate a parallel printer, color and composite monitors, even an RF modulator. All are standard interfaces; you don't have to give up an expansion slot to get them.

Many people prefer COMPAQ Portables to desktop computers because of their small footprint. Plus, because they're portable, they're ideal to share.

What's more, our monitors display high-resolution text and graphics, and rugged shock mounting protects stored data. Point being—this is one portable computer with no compromises.

For more information or the names of Authorized COMPAQ Dealers who can set up a hands-on evaluation, call 1-800-543-1300. Ask for Operator 270.

©1985 COMPAQ Computer Corporation. All rights reserved.

COMPAQ®

It simply works better.

Masscomp responds to slump with multiprocessing machines

Bruce J. MacDonald
Assistant Managing Editor

While many computer companies trim budgets and staffs in tactical moves against the downturn, Massachusetts Computer Corp. has opted for a more strategic decision: applying supercomputer technology to minicomputers to create an extended family of new multiprocessing machines.

The move is reshaping the Westford, Mass., company's image as a one-product, high-performance workstation vendor. More importantly for Masscomp, analysts expect the new family to turn the company around after a string of quarterly losses, which began last winter after more than two years of dynamic growth.

The company's strategy highlights the five-member 5000 family, a Motorola Inc. MC68020-based line of 32-bit multiprocessing machines. The machines range from a \$15,000 engineering workstation to a \$250,000 superminicomputer that can be configured with up to four processors; Masscomp claims it provides 11 times the Whetstone performance of a Digital Equip-

ment Corp. VAX 11/780 for less money. Indeed, it is price/performance that Masscomp believes will distinguish its "microsupercomputers" in the highly competitive scientific/technical market.

To achieve high processing speeds for relatively low cost, the machines incorporate a triple-bus architecture. Also, four of the five machines have two-way associative cache memory and supercomputer-like elements such as floating-point and array processors.

The introductions reflect a steady sales shift for Masscomp, which made its name and much of its revenue in the real-time data-acquisition business. When shipments of the MC-500 (renamed the 5500 and upgraded from an MC68010 CPU to the 68020) first began in late 1982, 70 percent of the company's single-model sales were for data acquisition. Data acquisition now accounts for only about 40 percent of Masscomp's annual sales and the company does not anticipate the share will increase. Sales of machines for scientific and technical applications make up the balance.

"They're capitalizing on a definite

trend within their customer base—a move away from the real-time area to more scientific or technical computing," says Jeffrey Canin of Hambrecht & Quist Inc., a San Francisco investment banking company. The market potential is much greater, too, he adds, estimating that hardware sales alone for scientific, FORTRAN-intense applications will total \$5 billion to \$6 billion this year. Real-time data acquisition, on the other hand, "is limited and tends to be very much a replacement market." He estimates that of the \$3 billion to \$4 billion annual data-acquisition market, approximately \$2.5 billion is controlled by DEC and Hewlett-Packard Co.

The new products are also timely. In March, Masscomp suffered its first quarterly loss (\$506,000) after two years of steady growth in which revenues had jumped from \$2.6 million to \$45.2 million. A \$1.7 million loss followed in June, chased by a \$3.29 million loss in September, the first quarter of the company's 1986 fiscal year. In August the company cut salaries by 6 percent to 12 percent for all 550 employees; in late October it laid off 12 percent of the staff.

According to both analyst Canin and Masscomp vice president for marketing, Douglas Rowan, the company was hit particularly hard by its dependence on OEMs, to which 50 percent of sales—slightly more than 1,500 units to date—are made. "That's impacted the company significantly in terms of the profit levels and the revenue growth," says Canin. Adds Rowan: "We were totally dependent upon essentially a single product [the MC-500], based upon the 68010, and we had very good customers who were waiting for the new round of 68020 machines and that also really hurt us for a couple of quarters."

In the rush to get product to market and improve its fortunes, Masscomp reportedly had models of its machines in beta test within two weeks of receiving the new chips from Motorola. But

Masscomp's 5700, the largest and fastest of the company's new multiprocessing, MC68020-based 5000 family, can be configured with up to four CPUs to reportedly provide 2½ times the performance of a DEC VAX 8600 for a third of the cost.

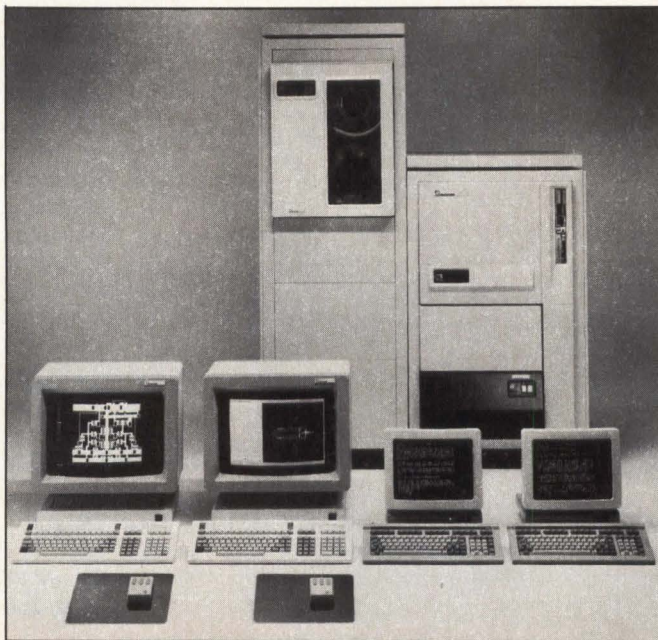

It's not just that the COMPAQ DESKPRO is a best-seller...

It's why.

In four months the COMPAQ DESKPRO® became the world's second-best-selling 16-bit personal business computer.

The modular COMPAQ DESKPRO expands from entry level to advanced computing, with up to 30 Megabytes of fixed disk storage. Select the exact features you need, including tape back-up. In fact, you can have up to four *internal* storage devices (the IBM® PC or IBM PC/XT™ can have only two).

Interfaces for a parallel printer, RGB color and video composite monitors, and RF modulator are built in. So you don't use up expansion slots for them. On other computers you probably would.

You also get uncompromising compatibility with the most popular peripherals and with thousands of the most popular business programs. And the COMPAQ DESKPRO runs programs two to three times *faster* than either the IBM PC or IBM PC/XT.

The COMPAQ DESKPRO even comes with a better monitor.

You get high-resolution text and graphics on one screen, saving the cost of a second monitor.

The COMPAQ DESKPRO continues to be a best-seller because it simply works better.

1. For entry-level computing start with one diskette drive and 128K RAM.

2. Add a second diskette drive when the work load calls for it.

3. If your files get larger, add a 10-Mbyte fixed disk drive.

4. Getting new memory-hungry software? Upgrade to 640K RAM.

5. Monster spreadsheet sheets are no problem. Add an 8087-2 math co-processor.

6. Protect reams of data on a pocket-sized tape cartridge by adding a tape back-up.

For more information or the names of Authorized COMPAQ Dealers who can set up a hands-on evaluation, call 1-800-543-1300. Ask for Operator 270. ©1985 COMPAQ Computer Corporation. All rights reserved.

COMPAQ®

It simply works better.

introduction was delayed, says Rowan, until "we had customers experienced with it—until we had a major product-shift capability."

Redefining a workstation image

That shift has turned the essentially one-product company, positioned against such workstation vendors as Apollo Computer Inc., DEC, HP and Sun Microsystems Inc., to one that now draws competitive comparisons all the way up to Cray Research Inc. supercomputers. At the low end is the 5300 for workstation applications and data acquisition and control, with an entry-level price of \$15,000. It is the only system to use the 12.5-MHz 68020; all other models incorporate the 16.7-MHz version of the chip.

The next machine is the 5400, priced from \$20,000, which can be configured with Masscomp's optional "Lightning" floating-point accelerator and is designed for standalone or networked technical applications or data acquisition.

The 5500 is optimized for multitasking, multiuser applications, and available with optional floating-point and array processors, for a starting price of \$23,500.

The 5600, priced from \$34,000, has been designed for technical computing requiring high-bandwidth data transfer and is also available with floating-point and array processors and the Lightning floating-point accelerator. Like the 5500, it can be configured with dual processors.

The top-of-the-line 5700, for I/O-intensive tasks, is available with up to four CPUs and four system I/O paths for a reported floating-point performance of more than 12 million Whetstones per second. Prices begin at \$71,000 and range as high as \$250,000.

While the 5300 and 5400 will target the workstation market that Sun addresses with models such as the 2/130 and 3/160 and Apollo with its DN 560-2, the price/performance of Masscomp's larger models moves the company squarely into minisupercomputer turf. The 5700 is said to run at up to 10 million instructions per second, and provide up to 1 million samples per second for data-acquisition purposes.

Masscomp also claims that for a third of the cost, the 5700 offers 2½ times the Whetstone performance of a VAX 8600—the machine by which minisupercomputer makers like Alliant Computer Systems Corp., Convex Computer Corp. and Floating Point Systems Inc. tend to measure their systems. By comparison, Alliant's FX/1 and FX/8 range in price from \$270,000 to \$1 million.

At least one analyst feels the move is key to the company's health. "Masscomp is probably not going to be able to effectively compete as a supplier of what's going to become the standard work-system," surmises analyst Adam Zais of International Data Corp., Framingham, Mass., who anticipates that the price for single-user workstations will drop to \$6,000 to \$7,000 by the end of the decade. "They have to position themselves against people [minisupercomputer makers] like Floating Point, Alliant, Convex and ELXSI....My initial take is that they're trying to change their market strategy from being considered Apollo-Sun-Masscomp to be more like Alliant - Convex - Floating Point-Masscomp. If you consider the marketplace, there are a lot fewer of those guys than there are in the workstation business."

To keep system speed up and cost down, Masscomp has incorporated a number of innovative techniques in its multiprocessing architecture, several of which draw directly from mainframe technology. The triple-bus architecture allows the systems to keep up with the speed of the 68020 processor—about three times faster than the 68010. The architecture comprises a proprietary memory bus for the CPU(s) and memory; a standard system bus, Multibus, for the data-acquisition and control processors, peripherals, graphics and networking; and a data-acquisition bus, STD+bus, for digital I/O, digital/analog converters and clocks. All the systems except the 5300 employ the two-way associative cache memory to speed up computation and reduce bus contention.

Masscomp's Lightning floating-point accelerator, available on all models except the 5300, is said to process

floating-point calculations at rates of between 3 million and 12 million Whetstones per second, depending on the number of CPUs. Speed is boosted further by Masscomp's array processor, the VA-1 Vector Accelerator, which provides high-speed, single-precision vector arithmetic such as fast Fourier transforms on the 5500, 5600 and 5700. By pipelining mathematical operations and overlapping data transfers with computation, it reportedly offers as many as 13 million floating point operations per second on the 5600 and 5700.

The new family runs Masscomp's version of real-time UNIX, RTU, to provide the response characteristics necessary for real-time work—something that UNIX, originally developed for timesharing, was not designed to do. Masscomp's version, which is compatible with both UNIX System V and Berkeley UNIX Version 4.2, incorporates fixed priority scheduling, prioritized asynchronous system traps, high-speed pipes and shared memory.

The 'thousand-chicken approach'

But while analyst Zais believes Masscomp has indeed redefined its market, he questions whether such multiprocessing can be fairly compared with the parallel-processing architectures provided by the Alliants and the Floating Points. "If you consider a minisupercomputer or microsupercomputer market," he explains, "you've got to have some true parallelism start creeping in—multiple-instruction, multiple-data stream stuff. In this case they're working on the microprocessor using what someone calls the 'thousand-chicken approach.' In other words, it's low-granularity—small-grain as opposed to large-grain. And it's also more loosely coupled than tightly coupled....It's not true parallelism. It's more like supercomputer stuff—array, vector, matrix stuff."

Regardless of how the company achieves its competitive price points, analysts concur that the new range should broaden OEM and third-party opportunities. Says Canin: "One can look at the products and perceive Masscomp as a workstation company,

It's not just that COMPAQ 286 Computers are getting rave reviews...

It's why.

Since we introduced the COMPAQ DESKPRO 286™ and COMPAQ PORTABLE 286™, the accolades haven't stopped:

InfoWorld: "(COMPAQ DESKPRO 286 is) a superb performer. It races through its tasks with efficient competence and heartwarming speed. Most IBM PC programs worked much faster than on the PC or XT. Wordstar's speed is a joy. Lotus' 1-2-3 zips along... this machine will outperform the AT."

PC Week: "...the machines IBM should have built." "...significant user advantages over IBM's machine... a standard dual-mode monitor, reliable tape backup, ... better construction than IBM's, an impressively fast drive and other little extras—at a price below similarly configured IBM's."

Popular Computing: "...genuine enhancements, such as higher CPU speed, greater RAM capacity, portability, ... greater hard-disk capacity, and an optional tape backup unit."

Why are the COMPAQ® 286 computers getting such rave reviews? They simply work better.

For more information or the names of Authorized COMPAQ Dealers who can set up a hands-on evaluation, call 1-800-543-1300. Ask for Operator 270.

©1985 COMPAQ Computer Corporation. All rights reserved.



COMPAQ®

It simply works better.

but that would be ignoring the fact that the company has provided such added value through their triple-bus architecture and their proprietary array processor and floating-point accelerators. The 68020 is only one component of a very high-performance architecture. And it's now been clearly proved that the architecture, even as announced in the original box [the 500], was very flexible in enabling future extensions."

That optimism is shared by Masscomp, which expects to do as much as 40 percent to 50 percent of its business this quarter with its new machines,

with the balance made up by the re-named 5500.

The company also anticipates that its ratio of sales to OEMs and end-users will remain about equal for the foreseeable future. Masscomp numbers approximately 70 OEMs in its list of customers, among them Gerber Scientific Inc., Graftek Inc., Harris Corp. and the National Aeronautics and Space Administration, which it serves both directly and through three different OEMs for as much as 8 percent of its annual business.

Despite a difficult 1985, the picture

for Masscomp is soon to get brighter, say analysts. Based on the expectations of its current OEMs, predicts Canin, the company should see a strong second half to its fiscal 1986 year, which ends in June. Canin cites the company's reputation for product reliability, which stems from Masscomp's background in real-time data acquisition (the company says there is a mean time between failures of one year on its machines), adding, "They're very well-endowed with cash. They're clearly going to be able to get through the current malaise." □

GSS adds raster capability to its virtual device interface

Mike Seither

Associate Western Editor

In a move to better penetrate business and engineering markets, Graphic Software Systems Inc., Wilsonville, Ore., has added raster graphics capability to its latest implementation of the virtual device interface (VDI).

The new version of the VDI, called GSS CGI for computer graphics interface, will allow programmers to use bit-mapped graphics to create applications with higher quality text, pop-up menus and windows, the company says. The name of the product, too, signals an expected change in the nomenclature of CDI, according to officials in the company.

ANSI, which has proposed the VDI standard, is apparently considering changing its designation to computer graphics interface, or CGI. By using the acronym, CGI, for its newest product, GSS hopes to better identify itself with the emerging graphics standard. That standard provides a functional interface between application programs and a wide range of graphics input and output devices, such as printers, plotters, scanners, cameras and terminals.

GSS president Tom Clarkson says that the company's latest release will "further establish GSS as the industry leader in microcomputer graphics soft-

ware...GSS CGI solidifies our position as the de facto virtual device interface standard."

However, some industry analysts question that line of reasoning. One of them is Robert Lefkowitz, director of software services at Infocorp., the Cupertino, Calif., market research outfit. "There is no single industry standard, and in my view there won't be one for a good long while," says Lefkowitz.

Although AT&T Co. and IBM Corp. adopted GSS' earlier version of the VDI interface, Lefkowitz says that the company "is still struggling for recognition" against competitors like Digital Research Inc. and Microsoft Corp., both of whom also have raster-based graphics products.

Deme Clainos, vice president of marketing for GSS, says the company has designed the bit-mapped management directly into the device drivers, and not into the application. As a result, programmers using GSS CGI do not have to modify an application every time a driver is added for another input or output device, he says.

To date, the company has developed more than 50 separate device drivers for its previous implementation of VDI, all of which will run on the new version. With the introduction of GSS CGI, an additional 17 drivers have been made available, among them ones for IBM's adapters for color and

enhanced graphics as well Big Blue's PC printers for color and graphics. Also available are drivers for Microsoft's serial and parallel mice; Epson America Inc.'s MX80, FX80 and FX100; Hercules Computer Technology's monochrome graphics card and Hewlett-Packard Co.'s 7470 and 7475 plotters. GSS says it plans to write more raster-based drivers later, adding that it has agreements to write a driver for a Ricoh Corp. scanner and port GSS CGI for use in Convergent Technology Inc.'s UNIX and proprietary operating systems.

GSS is positioning the software for a number of applications, including desktop publishing, business graphics presentations, architecture, engineering and construction, where quality and quantity of type fonts are important features.

In that regard, GSS CGI provides Helvetica currently, and the company expects to ship Times and Century in the first quarter of 1986. GSS CGI pixel arrays are read, written and saved in ASCII, binary or metafile formats.

Analyst Lefkowitz adds that the importance of raster graphics is its ability to "fill" characters, no matter what size, with individually addressable pixels on the screen. That degree of precision allows a wider latitude in the choice of type designs. The OEM price for GSS CGI is \$200. □

It's not just that COMPAQ Personal Computers are used in more top companies than Apple, Wang, Tandy, Hewlett-Packard, Digital, AT&T, Data General, NCR, NEC...



It's why.

In just three short years, COMPAQ[®] Personal Computers have gained greater acceptance in business than computers with much better known names. A recent survey* of Fortune-ranked U.S. corporations revealed that more major companies use COMPAQ Computers than any other brand except one. IBM[®] is the sole exception, and COMPAQ is quickly narrowing their lead.

Such success is due to the quality of COMPAQ products. They are repeatedly rated faster, more flexible, more expandable, and more compatible than their competition. In fact, COMPAQ Computers are actually more compatible with IBM personal computers than the IBM computers are with one another.

See for yourself why COMPAQ Computers have surpassed so many.

For more information or the names of Authorized COMPAQ Dealers who can set up a hands-on evaluation, call 1-800-543-1300. Ask for Operator 270.

©1985 COMPAQ Computer Corporation. All rights reserved.

*Source: Newton-Evans Research Co. 1985 survey.

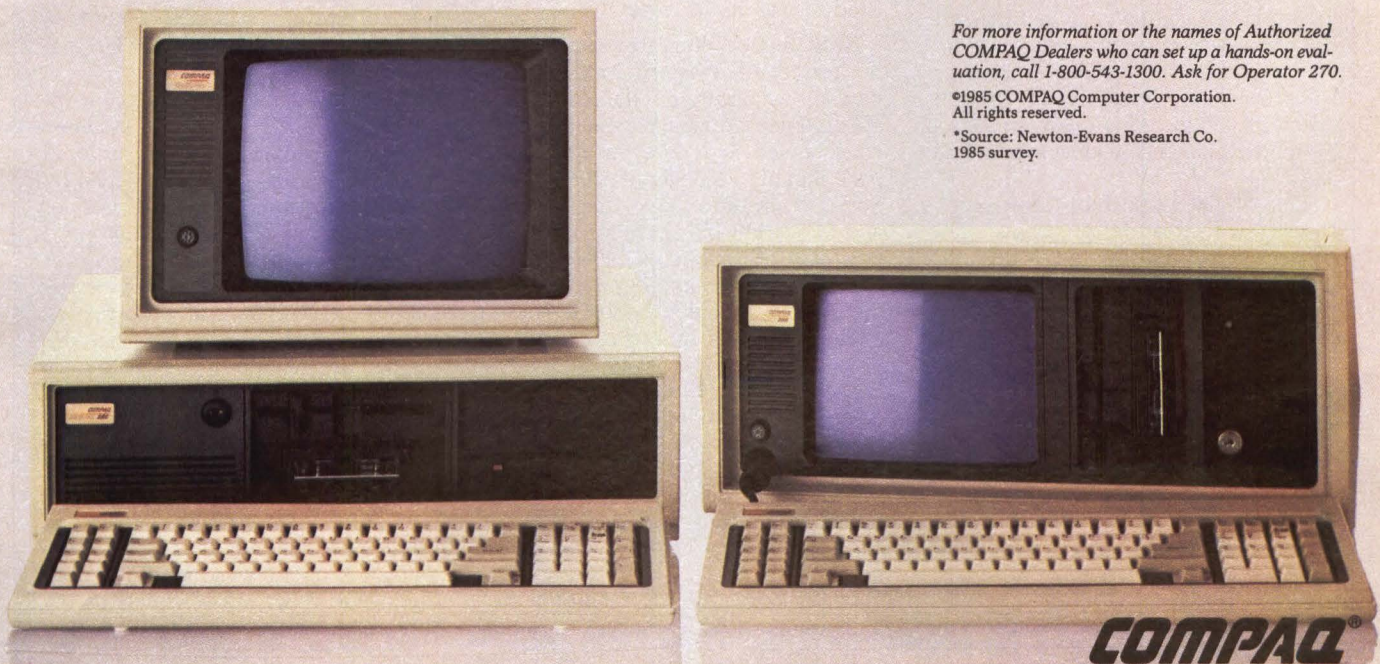

COMPAQ[®]

It simply works better.

HEARD ON THE HILL

U.S. microelectronics top Soviet shopping lists

Stephen J. Shaw
Washington Editor

Like housewives planning family meals, Soviet military strategists routinely prepare lists of restricted high-technology items for their foreign operatives to acquire from the United States and its Western allies.

According to a recent report prepared by the CIA and released by defense secretary Caspar Weinberger, the latest shopping spree has left Soviet shelves well-stocked. In fact, during the past 10 years, thousands of Western high-technology products have been obtained through both legal and illegal means. Billions of rubles and hundreds of thousands of man-hours have been saved in research and development efforts by the Soviet military by this infusion of existing Western technology into the Soviet military-industrial base.

"Each year Moscow receives thousands of pieces of unclassified, classified and proprietary documents as part of this campaign," summarizes the report. "Virtually every Soviet military research project—well over 4,000 each year in the late 1970s and over 5,000 in the early 1980s—benefits from these technical documents and hardware."

The Soviet acquisition effort comprises two separate programs. The first is managed by the VPK, the Military Industrial Council that forms the defense-production arm of the Presidium's Council of Ministers.

Working mainly through Soviet and Eastern Bloc intelligence services, the VPK program seeks military hardware, blueprints, product samples and test equipment. After the acquired documents are studied or the equipment is subjected to reverse-engineering, the technology learned is incorporated into Soviet military manufacturing.

The second program, managed by the Ministry of Foreign Trade and

several Soviet intelligence services, obtains great quantities of manufacturing and test equipment to incorporate directly into production lines. Largely through subterfuge, this program targets export-controlled microelectronics, computers, communications, robotics and other equipment to increase the productivity of Soviet weapons industries.

In the mid 1970s, the VPK program succeeded in acquiring the architecture of the IBM Corp. 360 and 370 computer systems and using it as the model for the country's Ryad computer series. In the late 1970s, VPK requested and got a Fairchild Instrument Corp./Xincom semiconductor memory tester. With it, a Soviet counterpart was developed. The original tester, according to the report, could also be used to copy or reverse-engineer Western integrated circuits. The tester and its design components saved several hundred man-years of Soviet development, the CIA estimates.

Silicon trail leads West

Most Soviet integrated circuits can be traced to Western origins. The best-known example is the Intel Corp. 8080A microprocessor, which the Soviets copied and gave an equivalent part number, KRS80 IK80A. Other Soviet microprocessors, the Logika-2 and Series 133/155, were attributed to the Texas Instruments 5400/7400 IC.

Other U.S. technology secured by the Soviets includes bubble-memory systems for use in tactical missiles, disk drives for the Ryad computers and documents on digital signal-processing for a Soviet version on the NAVSTAR satellite navigation system. "Soviet requirement data also includes the firms and sometimes the names of persons who have the desired hardware and documents," the report adds.

In response to VPK requirements, approximately 30,000 pieces of Western hardware and 400,000 technical

documents were collected between 1976 and 1980. The report estimates that one-third of all the VPK's annual requests are fulfilled, and that VPK requests grow 15 percent a year.

The Soviet Ministry of Foreign Trade is largely responsible for managing most covert diversions of export-controlled Western technology. Various techniques are employed, from deceptively describing equipment and falsifying identities of end users to illegal purchases, creating dummy companies and using unscrupulous Western traders.

Of particular interest to the Soviets are microelectronics fabrication equipment and computers. In this area, the Soviet trade-diversion program is credited with shaving the Western lead of from 10 to 12 years in the mid-1970s to four to six years today. Now the Soviets are after large quantities of test equipment for VLSI circuits, according to the report.

The Ministry of Foreign Trade's diversion program is characterized by volume purchases, both lawful and unlawful. For instance, before 1980 the Soviets bought hundreds of tons of electronics-grade silicon. In 1980, sales to the Soviet Union were restricted, but Soviet acquisitions continued through shipment diversions from the United States, West Germany and Japan.

Integrated circuits intended for direct use in Soviet computer systems, states the report, are usually ordered from the United States and Japan by trading companies in various parts of the world, then shipped through third parties in huge quantities to the Soviet Union or other East European destinations. The report estimates that as many as 100 million circuits may be shipped annually in this fashion.

The CIA report implies that understanding the scope of Soviet methods of getting hold of Western technology is a critical first step in preventing that technology from being turned against the United States and its allies.

"The assimilation of Western technology is so broad that the United States and other Western nations are thus subsidizing the Soviet military buildup," the report concludes.

It's not just that COMPAQ encourages side-by-side evaluations...

It's why.

The trade press has dubbed COMPAQ® Personal Computers the Cadillacs of the compatibles for reasons obvious to anyone who sits down at one.

COMPAQ offers you more. Whether it's unparalleled speed, unsurpassed expandability, our legendary compatibility and ruggedness, or a host of COMPAQ innovations.

It's easy to see why well over 300,000 satisfied users feel COMPAQ Computers simply work better.

COMPAQ's uncompromising dedication to quality is so apparent that we have become the fastest growing computer company in the world and the preferred alternative to IBM® in the office place.

Companies that try COMPAQ usually buy COMPAQ. And that's why we want you to get your hands on one.

To arrange for a free hands-on evaluation of a COMPAQ Computer, or to receive more information, send in the postage-paid reply card in front of this page, or simply call toll-free.

1-800-543-1300

©1985 COMPAQ® Computer Corporation. All rights reserved. IBM PC-AT™ and IBM PC/XT™ are trademarks, and IBM® is a registered trademark of International Business Machines Corporation.

COMPAQ®

It simply works better.

WE'VE SOLD
125,000 OF THE BOX
ON THE LEFT...

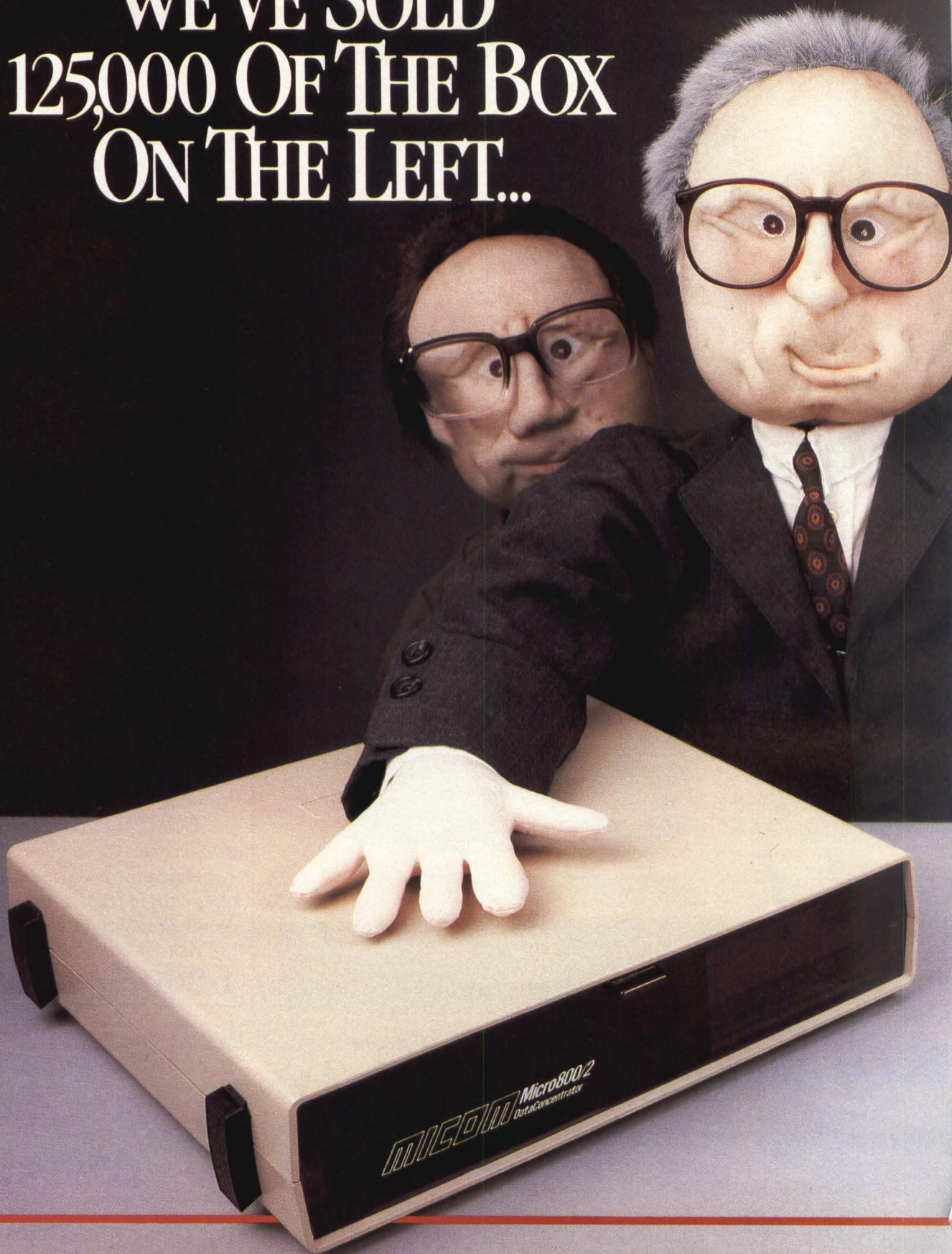

BECAUSE THEY'RE BUILT LIKE THE BOX ON THE RIGHT.

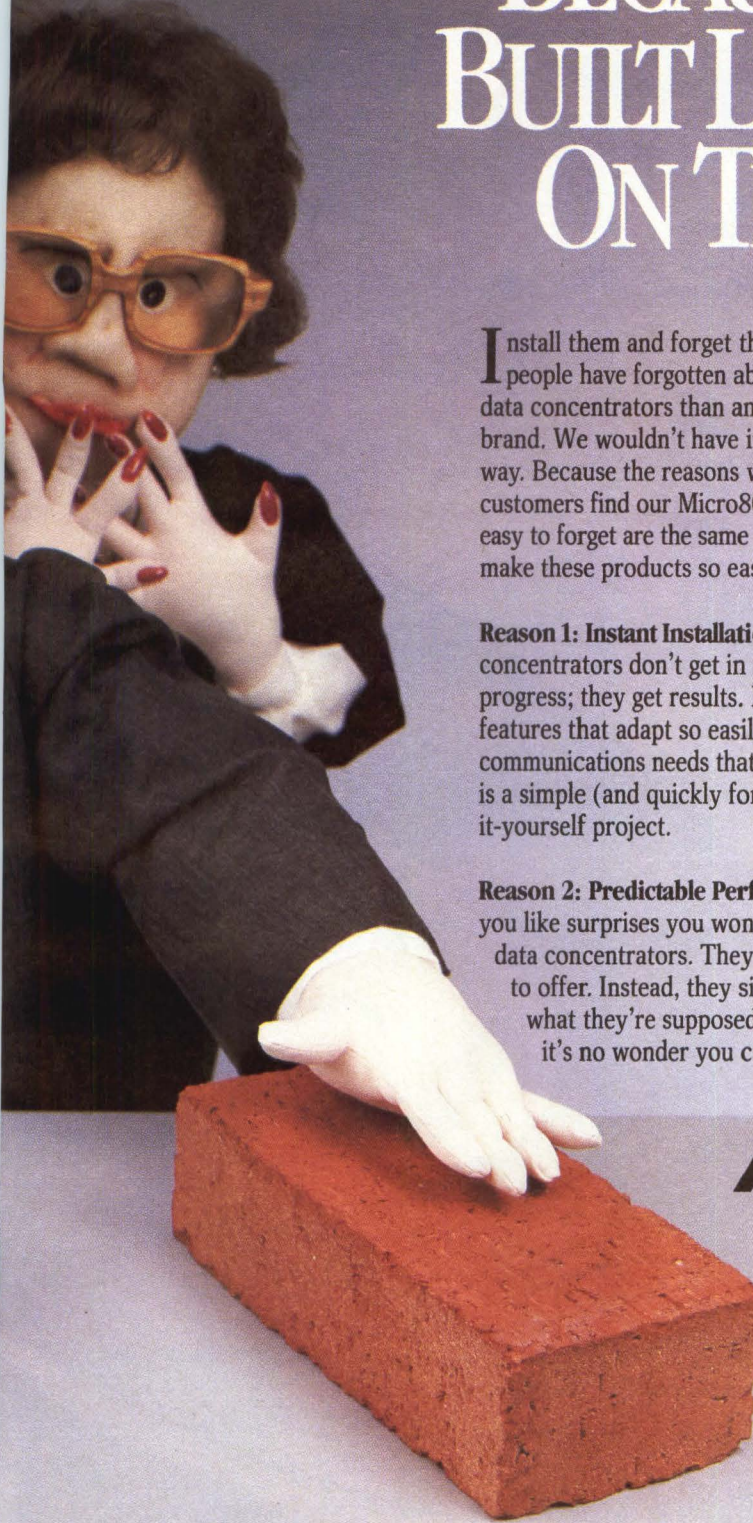

Install them and forget them. More people have forgotten about MICOM data concentrators than any other brand. We wouldn't have it any other way. Because the reasons why our customers find our Micro800 family so easy to forget are the same reasons that make these products so easy to buy.

Reason 1: Instant Installation. Our data concentrators don't get in the way of progress; they get results. Fast. With features that adapt so easily to your communications needs that installation is a simple (and quickly forgotten) do-it-yourself project.

Reason 2: Predictable Performance. If you like surprises you won't like our data concentrators. They have none to offer. Instead, they simply do what they're supposed to do. So it's no wonder you can easily

forget their presence in your network.

Reason 3: Remarkable Reliability. Built like a brick data concentrator means built to last... and last, and last. You can install any Micro800 product and forget about it for the next 45,000 hours of continuous operation.

THE NUMBERS CHANGE, BUT NOT THE MESSAGE

We launched our first data concentrator with the message, "Concentrate, it's cheaper!" Now, 125,000 shipments later, we offer the industry's most extensive family of data concentrators dedicated to the same fundamental objective: helping micro and mini-computer users communicate more... for less. To find out how we can help you, write to: MICOM Systems, Inc., 4100 Los Angeles Avenue, Simi Valley, CA 93062, or call 1-800 MICOM U.S.

MICOM®

SPEEDING INFORMATION ACCESS THROUGH OPTICAL DISK TECHNOLOGY

THE 301 SERIES OPTICAL DISK SUBSYSTEM

■ Hitachi's 301 Series optical disk subsystem enables a computer to access as much as 5.2 gigabytes of on-line information. The 301 Series optical disk subsystem consists of a formatter/controller that handles as many as four disk drives, each having a write-once storage capacity of 2.6 gigabytes. The drives record data by employing a semiconductor laser to score microscopic pits on a 12-inch disk coated with a photosensitive tellurium-selenium medium. This proprietary technique produces sharply defined pits that can be read back with high accuracy and reliability.

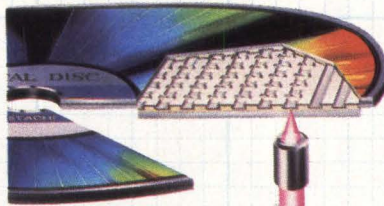

Disk Drive OD301A-1

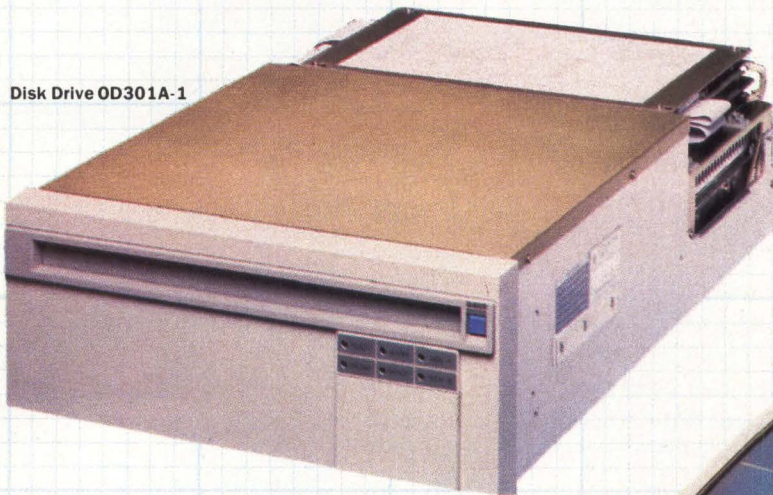

■ The 301 Series drive automatically checks each data bit after it is written and also records error-correcting bits. The combined use of read-after-write checking and error-correction codes reduces expected read errors to 10^{-12} , allowing storage of both image and encoded data.

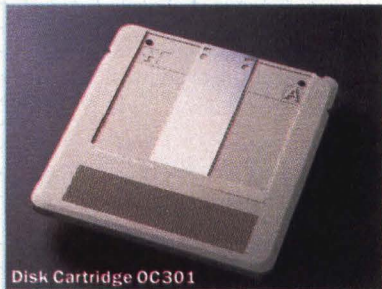

Disk Cartridge OC301

■ To assure data retention, the 301's disks are sealed in a glass envelope and then encased in an easy-to-handle plastic cartridge. The predicted data life of the doubly sealed disk is more than 10 years.

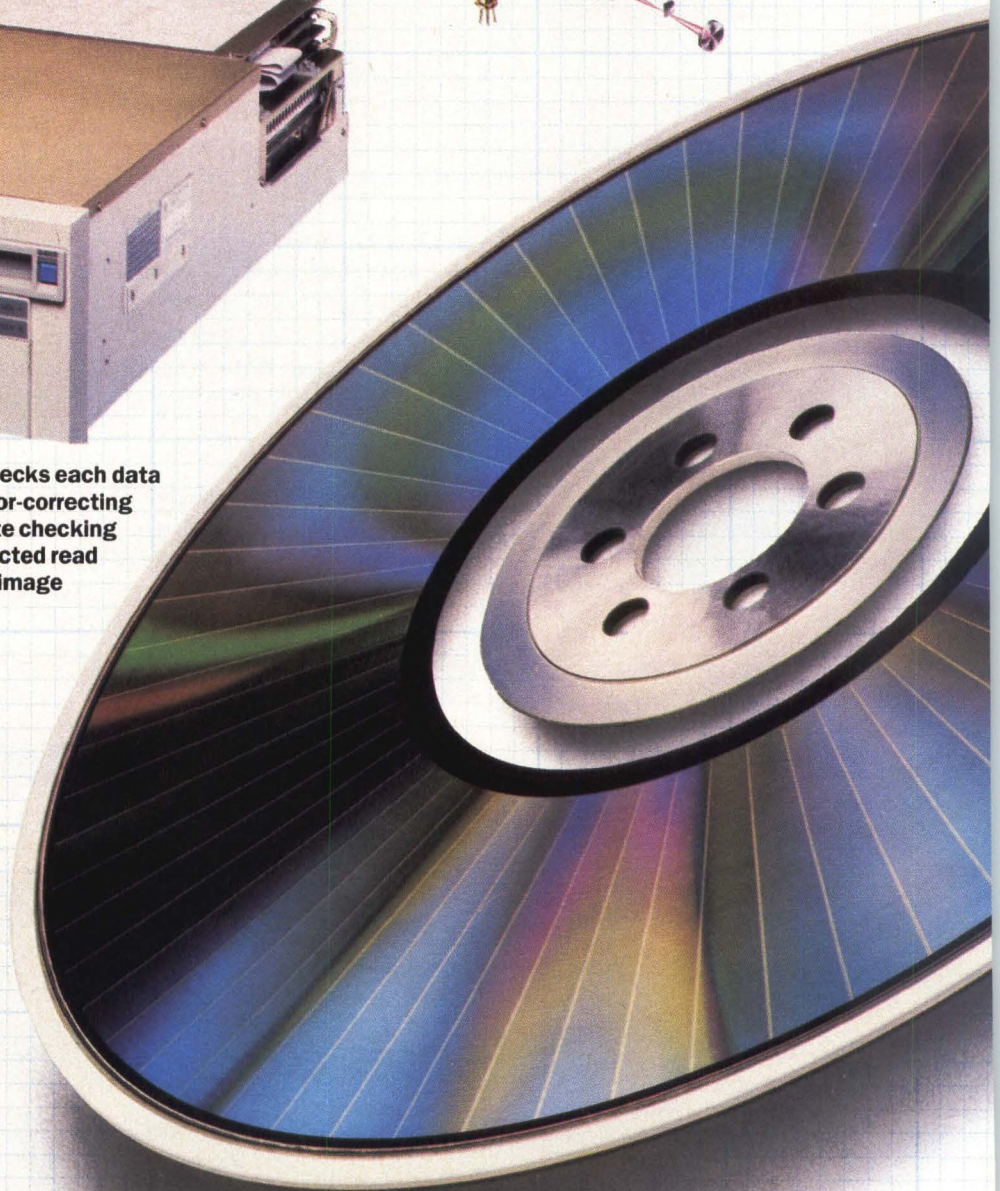

■ The 301's formatter/controller implements either the industry-standard SCSI interface or a GP-IB (IEEE-488) interface, which enables the disk subsystem to be used with a wide range of computers. The unit includes its own memory buffer to speed data transfer between a host computer and the disk drive, which has a 250 millisecond average access time.



Formatter Controller OF301S-1/2

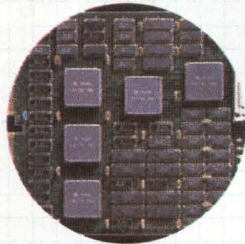

Hitachi Developed
6000 Gate LS1



Library Unit OL301S-11

■ The 301 Series library unit provides as much as 83 gigabytes of on-line storage capacity. It incorporates a formatter/controller, one or two disk units, and an automatic changer for as many as 32 disk cartridges.

How Hitachi's 301 Series Facilitate Information Storage and Retrieval

With the introduction of its 301 Series optical disk system, Hitachi has taken a giant step forward in speeding information access. Unlike conventional disk units, which record information magnetically, the model 301 stores data optically—by using a laser to inscribe microscopic pits on a specially coated disk surface and subsequently read them.

The results: a big leap in storage capacity per disk. A 301 Series system can store 2.6 gigabytes of information on a 12-inch disk. The 301 Series library unit, which combines an automatic disk changer with one or two drives, can store and retrieve 83 gigabytes of information—yet occupies no more space in an office than would a large filing cabinet.

The ability to record so much information so compactly opens vast new applications for on-line information storage and retrieval. For example, with the 301 Series, it becomes economically feasible to create extremely compact electronic archives for storing and retrieving copies of medical records, engineering drawings, and other documents, much faster than with conventional microfilm or magnetic tape storage. Other applications include electronic publishing and backup of volatile databases in large-scale information processing systems. For more information, contact:

Hitachi America, Ltd.

Computer Sales & Service Division
Peripheral Systems Marketing Department
950 Elm Avenue, San Bruno, CA 94066
Tel: 415/872-1902
or: 313 Speen Street, Natick, MA 01760
Tel: 617/655-5501

This 12-inch optical disk can store 2.6 gigabytes of images or encoded data.



CIRCLE NO. 20 ON INQUIRY CARD

Datapoint's ISO Program

The Right Line For The Bottom Line.

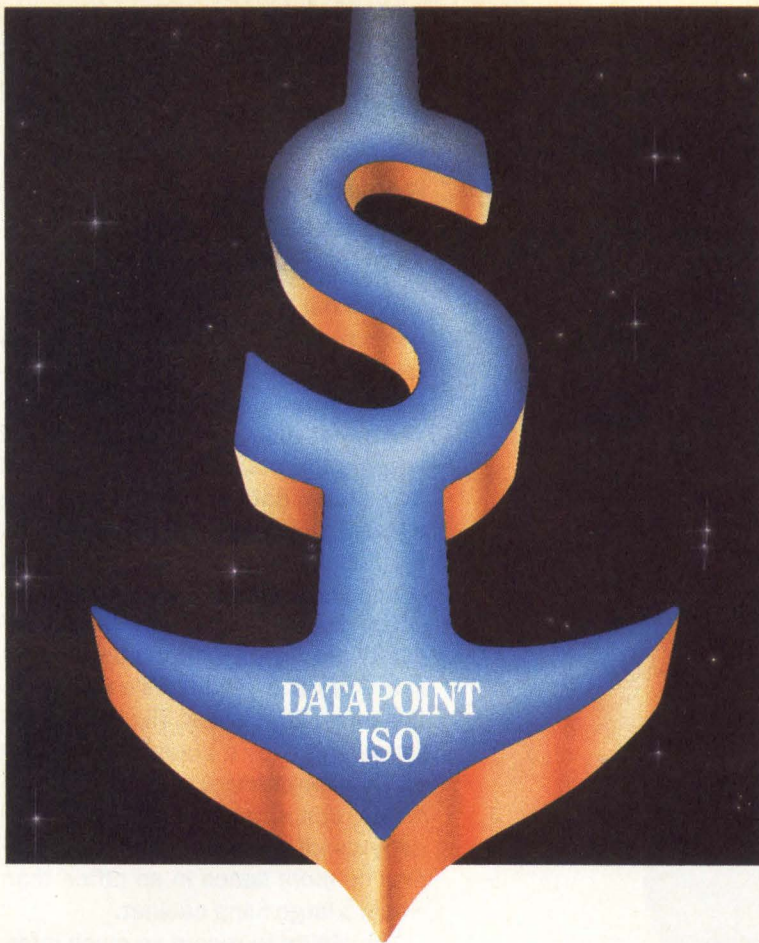

Product Features and Benefits

As a Datapoint® ISO, you'll enjoy the benefits of ARC® (Attached Resource Computer), the world's most thoroughly proven local area network . . . the only network capable of supporting these seven operating systems:

- ▶ Datapoint DOS
- ▶ Datapoint RMS® (Resource Management System®)
- ▶ MS-DOS®
- ▶ CTOS®
- ▶ CP/M®
- ▶ UNOS™
(a UNIX® look-alike)
- ▶ PC-DOS®

The ARC also features the most thoroughly integrated office automation applications including:

- ▶ Word Processing
- ▶ Electronic Mail
- ▶ Spreadsheets
- ▶ Calendar
- ▶ Calculator
- ▶ Telex Management
- ▶ Relational Database
- ▶ Report Writer

The ARC is also supported with extensive communications software making it the most integrated network available. And Datapoint makes application development easy with advanced proprietary and industry standard programming languages.

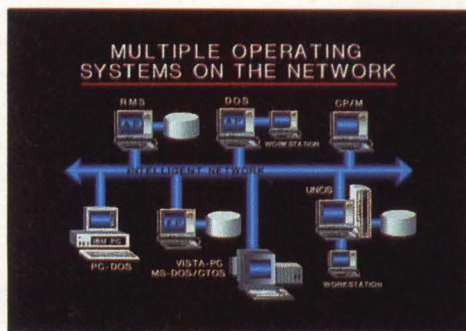

Program Features and Benefits

Everybody wants features and benefits. That's why everybody wants Datapoint. As a Datapoint ISO, you'll enjoy the benefits of working with the industry leader in network technology and office automation. You'll benefit from features like:

- ▶ The most aggressive discount schedule in the industry
- ▶ Complete customer financing
- ▶ The best development systems discounts
- ▶ Comprehensive product documentation and sales literature
- ▶ Field sales and systems support anywhere in the country
- ▶ Excellent co-op advertising assistance program
- ▶ Direct sales force assistance
- ▶ Trade show support
- ▶ Education assistance
- ▶ Annual ISO Conference
- ▶ Phone-in order system

You and your customers will benefit from the Datapoint products and their unique features, but the real benefit of our ISO Program is our solid support and the impact it will make on your bottom line.

For more information on Datapoint's ISO Program, call Guy Pearson at **800/824-7329**.
(In Texas 512/699-7850)

 **DATAPOINT**
The Right Line For The Bottom Line.

See Us at COMDEX in Booth #1792.

The "D" logo, DATAPOINT, RMS, and ARC are trademarks of Datapoint Corporation. CP/M is a trademark of Digital Research, Inc. PC-DOS is a trademark of IBM Corporation. MS is a trademark of Microsoft Corporation. CTOS is a trademark of Convergent Technologies, Inc. UNOS is a trademark of Charles River Data Systems. Unix is a trademark of AT&T.

CIRCLE NO. 21 ON INQUIRY CARD

VERTICAL MARKET INTEGRATOR

*Applying integrated systems
in industry, engineering and commerce*

LAN TIGHTENS FACTORY FLOOR CONTROL

The John Deere Harvester Works uses a MAP-compatible LAN to optimize parts production and speed information between computer room and factory floor

John Mizlo, John Deere Harvester Works

At a more-than-260-acre site in East Moline, Ill., the sheet-metal facility of the John Deere Harvester Works designs and produces farm combines. The facility handles all aspects of production—from punching and welding sheet metal to assembly and final inspection. Recently the company optimized its manufacturing operations by installing the Token/Net local area network from Concord Data Systems Inc., Waltham, Mass.

Deere Harvester uses numerical controllers (NCs) to feed cutting and tooling instructions to machine tools on the shop floor. By 1984, more than 30 machine tools were managed by numerical control. To improve parts quality and implement just-in-time techniques, however, it estimated that it would need 30 more NC machines by 1988. In addition, the number of software programs needed for these machine tools would increase accordingly—from 2,500 in 1984 to more than 12,000 by 1988. Faced with such growth, the company decided to develop a more efficient method of handling parts programs.

Previously, engineers custom-designed programs for each part and created punched mylar tape with a flexible disk copy for backup. The employees then hand-delivered the tapes to the shop floor—a quarter of a mile away—for loading onto the NC systems. The punched mylar tape fed information to the NCs, which in turn sent cutting and tooling instructions to machine

A Behrens laser press automatically punches sheet metal using instructions downloaded from the DNC in Deere Harvester's computer room.

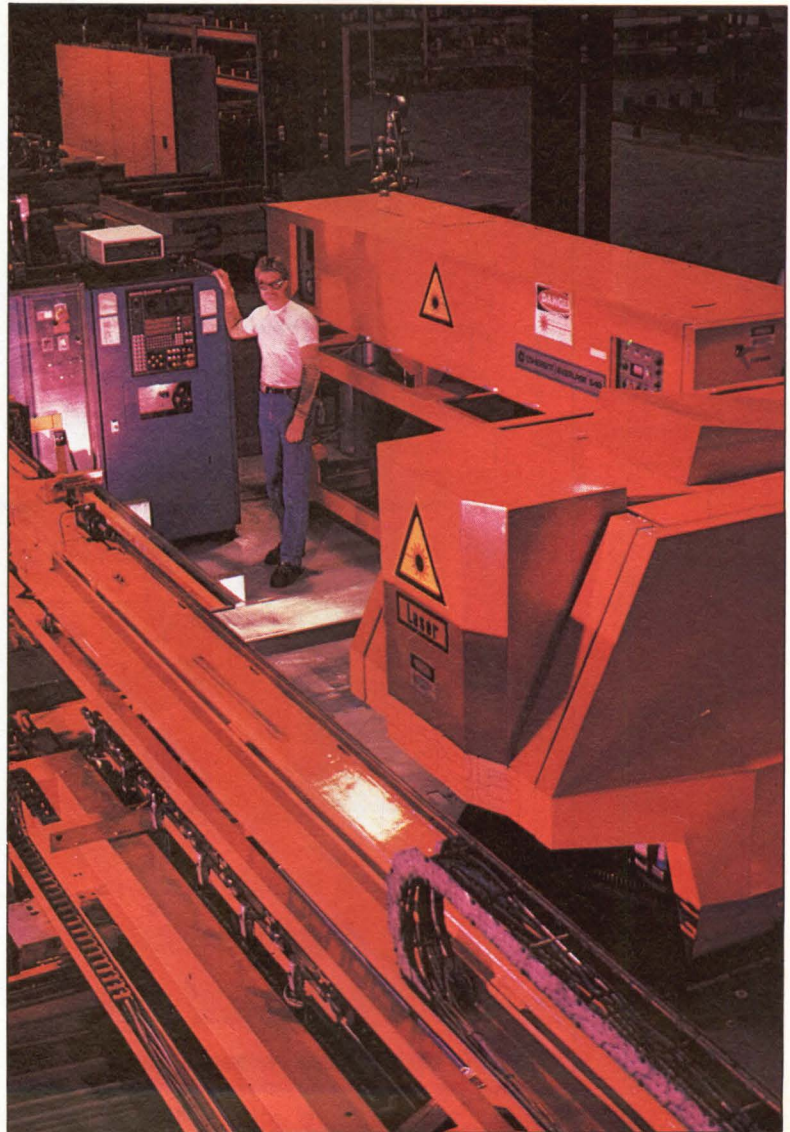

tools. If a program contained errors, an engineer would have to create a new tape in the computer room and hand-carry it back to the shop floor. These procedures took an average of half a day to complete.

DNC handles data flow

To optimize its operations, the Harvester Works installed a distributed numerical-control (DNC) system in its computer room. It planned to use the DNC system to store parts programs in a central location and to download them to the appropriate shop-floor computerized numerical-control (CNC) system. But this solution required an efficient method of transferring information. The company vetoed using point-to-point links from the DNC system to each CNC machine because the factory environment dictated large distances between links, making them impractical and expensive to install. Instead, with the advent of General Motors Corp.'s Manufactur-

ing Automation Protocol (MAP), which defines factory-floor communications, Deere Harvester decided to install a local area network. The LAN would be a pilot project for the company to determine if networking was feasible.

In August 1984, Deere Harvester formed a task force comprised of members from three departments—computer systems, plant engineering and production engineering systems—to evaluate various LANs and to develop and implement a network solution. The task force named two criteria for the LAN: compatibility with industry standards and broadband communications, allowing both asynchronous and synchronous communications.

MAP compatibility was essential

A very important criterion for the LAN was compliance with industry standards, specifically, MAP. This strategy was risky, however, because MAP was still developing. To ensure compatibil-

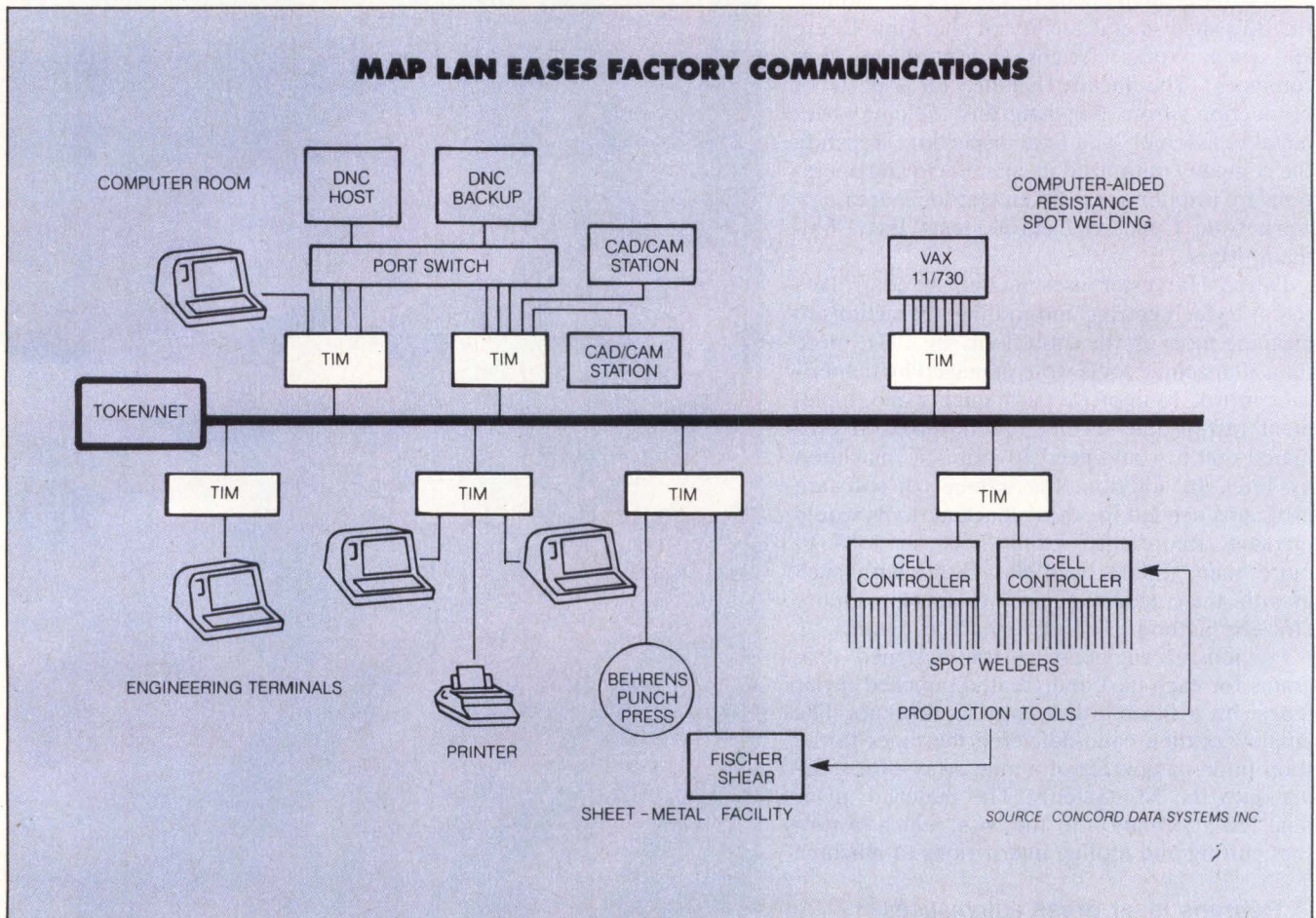

Token/Net provides factory communications via the Token/Net interface module (TIM), a three-board, four- to 12-port, micro-

processor-based communications controller that links production machine tools, engineering terminals and the computer room.

Gateway to anyware.



Thanks to our local and remote communications solutions, your PCs now have total access to the world around them. They can talk to other PCs. Share a wide variety of software and hardware. Access mainframes and public data networks. And take advantage of all the major network standards. From NetWare/G to DOS 3.1 to NETBIOS. From BSC to SNA to X.25.

G/NET™ is our Local Area Network for IBM PCs and compatibles, offering complete connectivity and flexibility. Start with a two or three node starter kit and continue adding hundreds of PCs into a shared resource environment featuring electronic mail, printer spooling, and multiple file and communications servers. Since G/NET uses the Novell NetWare/G family of network operating systems, you have instant access to over 1500 LAN applications. Everything from spreadsheets to specialized solutions for doctors, lawyers and other businesses. And with G/NETBIOS™ you can even run programs written for IBM's PC Network or Token Ring.

To reach beyond the LAN, we offer PC-to-host links and LAN-to-host gateways using async, bisync,

SNA or X.25 communications. LAN-to-LAN local and remote bridges. Gateways to X.25 public networks. And much more.

Think of us as your PC SafetyNet™. Because in addition to cost-effective products, we offer you the security of a total solution supplier. With complete service and support. Continued innovation so you won't get stuck with obsolete technology. Plus assured network performance. We've proven our superiority time and time again in benchmark tests against more expensive LANs. And in real life installations. Just ask any one of our more than 20,000 users.

So call the innovative communications experts at Gateway for your local distributor or dealer. And let your PCs explore our gateway to anywhere.

Gateway
communications, inc.
Your PC SafetyNet.™

16782 Red Hill Ave., Irvine, CA 92714. (714) 261-0762.

G/NET, G/NETBIOS and SafetyNet are trademarks of Gateway Communications, Inc. IBM and NETBIOS are trademarks of IBM Corporation. NetWare/G is a trademark of Novell Inc.

CIRCLE NO. 22 ON INQUIRY CARD

Both letter-quality and draft hard copy

Fastest document throughput in its class

Both friction and tractor paper feed

Industry standard serial and parallel interfaces.

Better, more versatile operator controls

TI reliability

Compatibility with third-party and proprietary software

Better, more durable easy-access font modules

The TI 855 microprinter. No other printer says better so many ways.

Feature for feature, no other microprinter can match the versatility, compatibility, reliability and productivity of the OMNI 800* Model 855 microprinter. Here's why.

Two Printers In One. With the TI 855 you get the speed of dot matrix draft copy. Plus the precise clarity of the most advanced matrix technology for letter-quality print. It's two printers in one — at one low price.

A Great Family Name. Texas Instruments is known for providing the world with the industry standard for printers — the TI 810. TI builds the same reliability into every 800 series microprinter. Both the 855 and the data processing Model 850 are part of the expanding TI line of high-performance, low-cost microprinters.

Hardware Compatible. The TI 855 microprinter is compatible with all major PC hardware. And it provides both serial RS232C subset and "Centronics-type" parallel as standard interfaces.

Software Compatible. The TI 855 uses industry standard escape sequences for compatibility with virtually all third-party software. And for those with proprietary software needs, a model is available with ANSI standard escape sequences.

Tough Font Modules For Quick Character Change. Three font modules can be inserted into the front of the printer at one time, and are accessed individually. Each contains both draft- and letter-quality character sets. They're easier to use, more reliable and more durable than traditional metal or plastic daisy wheels.

More Productivity Than Any Other Microprinter. The 855 offers both friction and tractor paper feed, to handle all types of word and data processing applications. A quick-change snap-in cartridge ribbon. Raster and mosaic graphics. And intelligent printing which maximizes document throughput — regardless of format.

Get the printer that makes for better information systems. For more information visit your nearest TI authorized dealer or write Texas Instruments Incorporated, P.O. Box 809063, DEPT. NO. 083MY Dallas, TX 75380-9063. Or call toll-free: 1-800-527-3500.



TEXAS INSTRUMENTS

Creating useful products and services for you.

ity, Deere Harvester specified an IEEE 802.4 token-bus solution, which implements the first two levels—the Physical and Data-Link layers—of MAP. The LAN required high-level software that implemented the International Standards Organization's seven-level model for open systems interconnection. This would ensure upward compatibility as MAP became more clearly defined.

Along with standards compatibility, the LAN had to include broadband communications because broadband can handle voice and video communications as well as data transmission. As a result, it could support a variety of applications, helping to justify the expense of installing coaxial cable throughout the factory. In addition, broadband signals resist dirt and noise and are thus better suited to industrial environments than are other communications signals. What's more, the extensive use of broadband by cable television companies ensures a stable, reliable product at a relatively low price.

Finally, the task force stipulated that the LAN have both asynchronous and synchronous terminal communications ability because the network could be used for several applications, requiring both kinds of communications. For example, the

network could connect CRTs for production inquiries, programming and machine monitoring.

Deere sent out a request for proposal and, after evaluating several MAP-compatible LANs, selected Concord's Token/Net. Deere Harvester felt Token/Net was the only solution that met its sophisticated technological requirements.

LAN yields productivity gains

The DNC system allows NC programs to be downloaded to machine tools on the factory floor over the LAN. If a program requires an update, an engineer simply accesses and corrects the program on the DNC system. The system then downloads the corrected software to the shop floor, and parts production continues.

Deere Harvester can now develop parts programs on a computer aided design/computer aided manufacturing system from Computervision Corp. and transfer the programs across the LAN to the DNC system for storage. Asynchronous terminals on the network allow users to access either the DNC or the CAD/CAM system from a single terminal.

Token/Net provides factory communications via the Token/Net interface module (TIM), a

Harvester's more-than-260-acre sheet-metal facility handles all aspects of production—from punching and welding sheet metal to assembly and final inspection.



Broadband can handle voice and video communications as well as data transmission.

three-board, four- to 12-port, microprocessor-based communications controller that links production machine tools, terminals and the computer room. For example, a TIM connects a Behrens laser punch press and a Fischer metal-cutting shear on the factory floor to the DNC system in the computer room. Other TIMs connect the CAD/CAM system, several engineering terminals and a printer to the network.

The TIM includes a high-speed radio-frequency modem, an access board that implements the token-passing protocol and a network-control unit that generates statistics and provides net-

work-management functions. Each TIM uses Concord's terminal-server software, which implements the higher layers of the ISO model and provides RS232 and RS449 switching.

The biggest problem in getting the network up and running was the lack of application software for communications since MAP standards are not yet developed. As a result, it was impossible for the DNC system to communicate with the CNC systems controlling the laser punch press and the shear. To solve the problem, software interfaces had to be developed.

The Harvester Works Token/Net LAN instal-

At each spot-welding station, a robot performs preliminary welding, and an operator adds the finishing touches. The equipment

is managed by controllers connected to the network via Concord's Token/Net interface modules (TIMs).

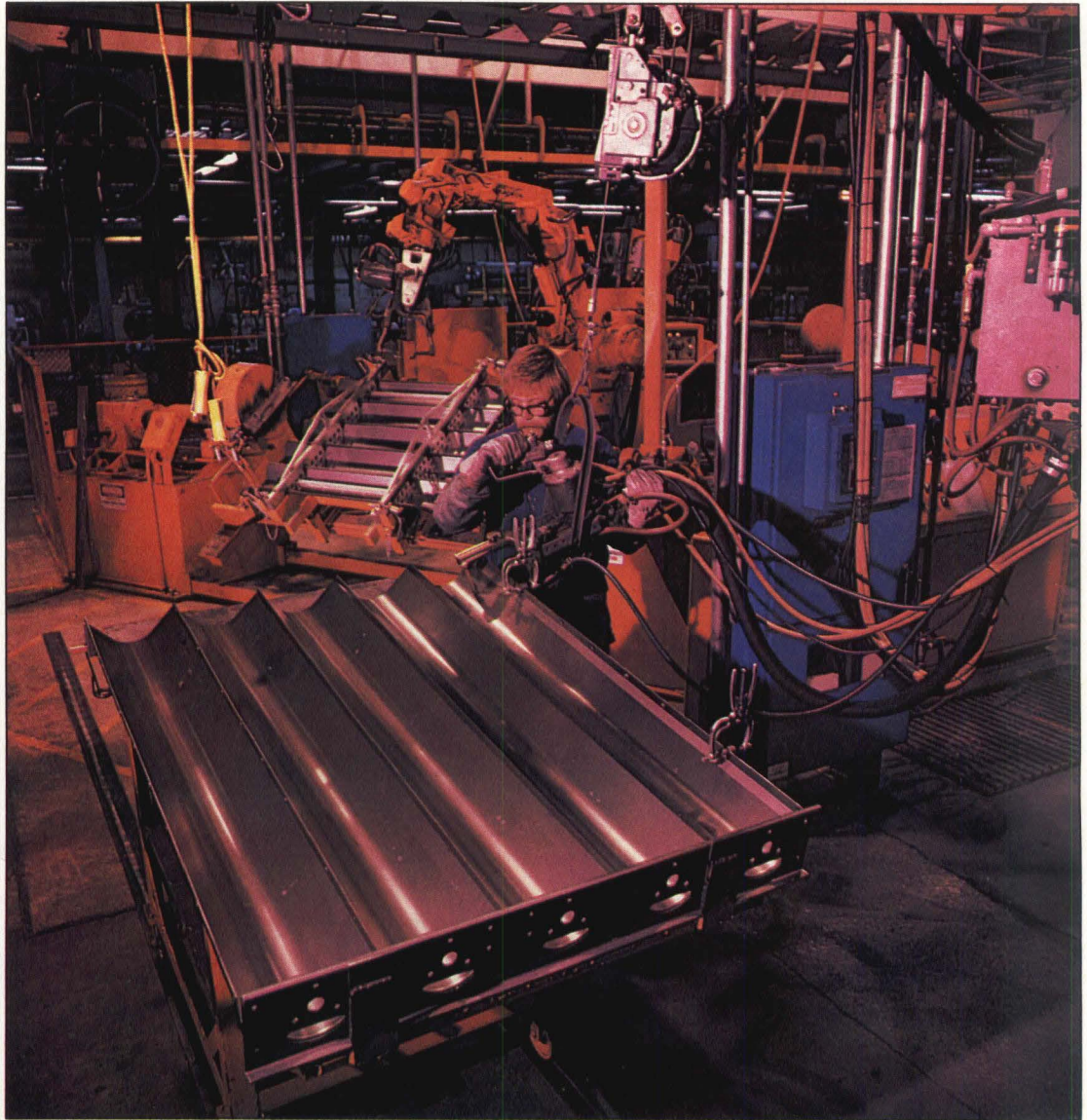

NEW SCO RELEASES!
XENIX SYSTEM V
FOR PC XT - AND PC AT - NOW!

"A UNIX™ TO BE PROUD OF!"

—Kaare Christian, PC Magazine

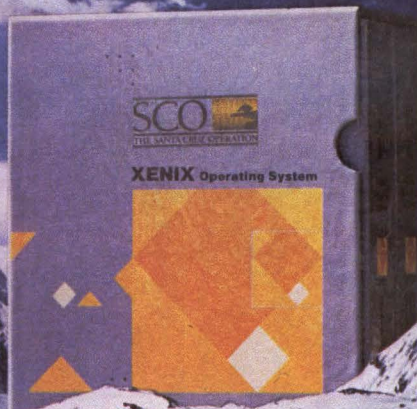

Mankind searched the world over
for the multiuser operating system of the future.

Then IBM® chose XENIX® for the PC AT. And the future was *now*.

THE SANTA CRUZ OPERATION PRESENTS

XENIX NOW!

AN SCO PRODUCTION IN EXCLUSIVE ASSOCIATION WITH MICROSOFT CORPORATION
THE MULTIUSER, MULTITASKING PC BLOCKBUSTER "XENIX NOW!"

STARRING VISUAL SHELL • MULTISCREEN™ • MICNET • THE BERKELEY ENHANCEMENTS

AND INTRODUCING **C-MERGE** AS THE MS-DOS DEVELOPMENT ENVIRONMENT

FEATURING WORLD FAMOUS SCO TRAINING AND SUPPORT FOR DEALERS • END USERS • ISVs • OEMs
AND AN INTERNATIONAL CAST OF HUNDREDS OF XENIX APPLICATIONS

INCLUDING **LYRIX™** AS THE UNIX/XENIX WORD PROCESSING SYSTEM

PRODUCED AND DIRECTED BY THE SANTA CRUZ OPERATION

SCREENPLAY ADAPTED BY THE SANTA CRUZ OPERATION FROM ORIGINAL STORIES BY MICROSOFT AND AT&T
IN BREATHTAKING SELECTABLE COLOR

NOMINATED FOR ★ BEST DOCUMENTATION! ★ BEST SUPPORT! ★ BEST TRAINING!

★ BEST ELECTRONIC MAIL AND NETWORKING! ★ MOST APPLICATIONS!

★ MOST COMPLETE UNIX SYSTEM!



RELEASED FOR MOST POPULAR PERSONAL COMPUTERS.
APPLICATIONS ALSO AVAILABLE: LYRIX, MULTIPLAN®, INFORMIX®,
LEVEL II COBOL™, 3270 MAINFRAME COMMUNICATIONS.

(408) 425-7222
TWX: 910-598-4510 SCO SACZ

M MULTIUSER OPERATION SUGGESTED
XENIX WILL TURN YOUR PC INTO A REAL COMPUTER

©MCMXXXIV The Santa Cruz Operation, Inc.
The Santa Cruz Operation, Inc., 500 Chestnut Street, P.O. Box 1900, Santa Cruz, CA 95061 (408) 425-7222

UNIX is a trademark of AT&T Bell Laboratories • Lyrix and Multiscreen are trademarks of The Santa Cruz Operation, Inc. • IBM is a registered trademark of International Business Machines Corporation • XENIX and Multiplan are registered trademarks of Microsoft Corporation • Informix is a registered trademark of Relational Database Systems, Inc. • LEVEL II COBOL is a trademark of Micro Focus, Ltd.

CIRCLE NO. 24 ON INQUIRY CARD

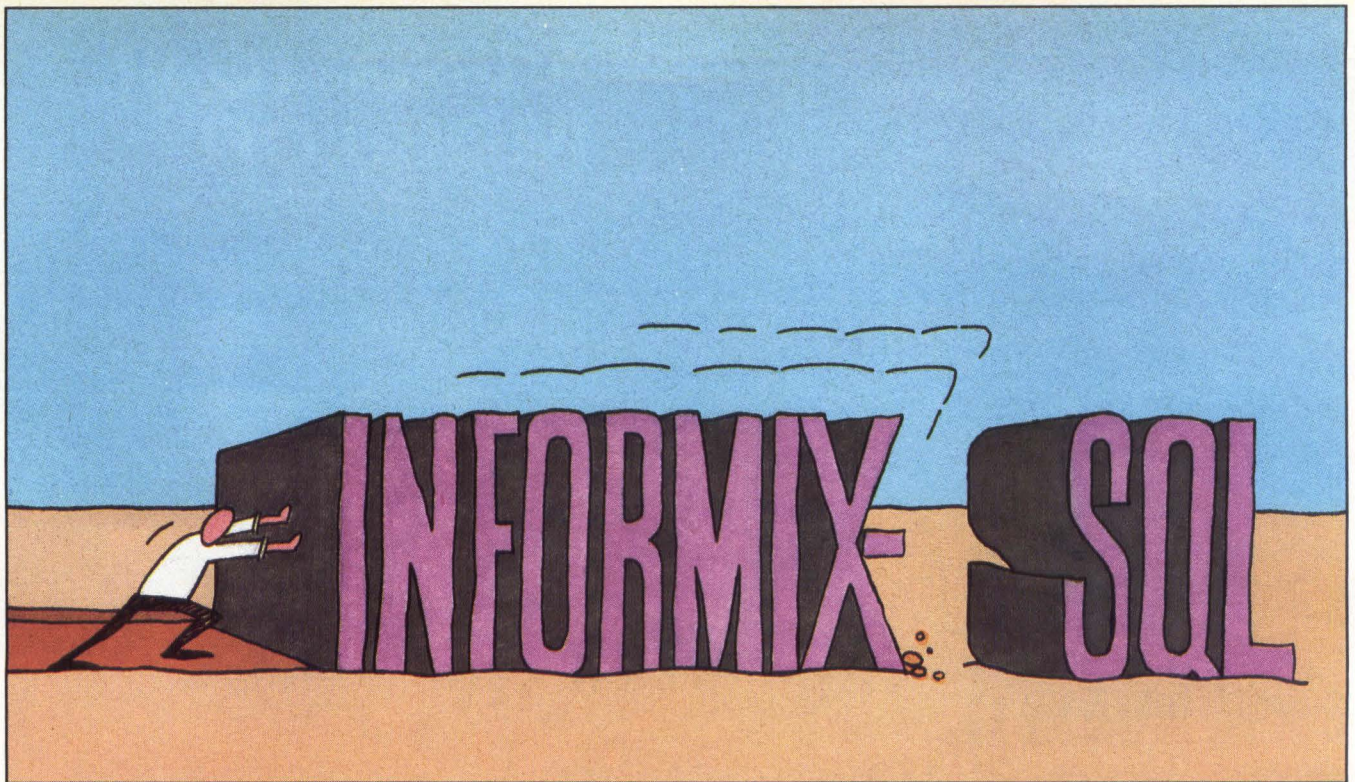

How we improved Structured Query Language.

Actually, we didn't change a thing.

We just combined it with the best relational database management system.

Introducing INFORMIX®-SQL.

It runs on either MS™-DOS or UNIX™ operating systems. And now with IBM's SQL as part of the program, you can ask more of your database. Using the emerging industry-standard query language.

To make your job easier, INFORMIX-SQL comes with the most complete set of application building tools. Including a full report writer and screen generator. Plus a family of companion products that all work together.

Like our embedded SQLs for C and COBOL. So you can easily link your programs with ours. File-it!™, our easy-to-use file manager. And C-ISAM,™ the de facto standard ISAM for the UNIX operating

system. It's built into all our products, but you can buy it separately.

And when you choose RDS, you'll be in the company of some other good companies. Computer manufacturers including AT&T, Northern

Telecom, Altos and over 60 others. And major corporations like Anheuser Busch and The First National Bank of Chicago.

Which makes sense. After all, only RDS offers a family of products that work so well together. As well as with so many industry standards.

So call us for a demo, a manual and a copy of our Independent Software Vendor Catalog. Software vendors be sure to ask about our new "Hooks" software integration program. Our number: 415/322-4100.

Or write RDS, 4100 Bohannon Drive, Menlo Park, CA 94025.

And we'll show you how we took a good idea and made it better.



RELATIONAL DATABASE SYSTEMS, INC.

INFORMIX is a registered trademark and RDS, C-ISAM and File-it! are trademarks of Relational Database Systems, Inc. IBM, UNIX and MS are trademarks of International Business Machines Corporation, AT&T and Microsoft, respectively. © 1985, Relational Database Systems, Inc.

lation continues to expand. For example, Deere Harvester is installing a computer aided resistance spot-welding system to improve welding quality. When installation is complete, Concord's TIMs will connect three cell controllers on the factory floor to a Digital Equipment Corp. VAX 11/730 minicomputer in the computer room. Each cell controller will in turn manage as many as 16 spot welders. The network will allow engineers to enhance production quality through monitoring and controlling the power and duration of welding along with other parameters.

Network increases flexibility

Deere Harvester also sees other possible benefits through linking DEC VT100 terminals that distribute job instructions to the factory's paint areas. Workers use these terminals to receive instructions and to report production. Each terminal currently connects to a dedicated VAX 11/750 minicomputer via twisted-pair wire and modems. The 11/750 schedules workers' tasks and instructs automated guided vehicles in the paint areas.

The company sees increased flexibility through the ability to access all systems from any location, as the greatest benefit in networking the factory's terminals. Because terminals could automatically log onto either the production or backup VAX system, the current backup bus switch would no longer be needed should the production VAX fail.

Deere Harvester sees other possible applications for the Token/Net LAN. Those under consideration include teleconferencing large meetings, using video cameras for security monitoring of remote areas and providing interactive video service for job training. □

John Mizlo is a system analyst at the John Deere Harvester Works, East Moline, Ill. He was responsible for installing the division's network.

Interest Quotient (Circle One)
High 483 Medium 484 Low 485

The biggest problem in getting the network up and running was the lack of application software.

FOR OEM AND VAR USERS

CHOOSE FROM SORD'S 68000 INNOVATIVE DESIGNS, INCREDIBLY LOW PRICES.

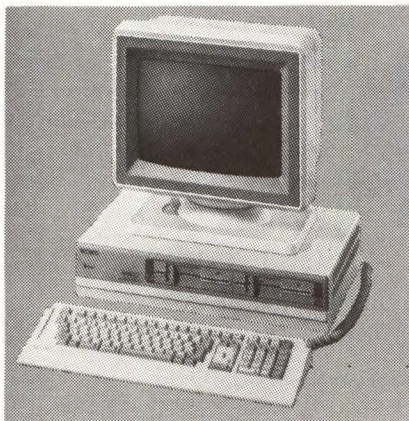

M68MX: Sample price - \$1,995

68000 CPU (10 MHz), Standard 512KB Memory up to 3.5 MB. Large external storage (Max. 100 MB). High Resolution (640 x 500 Pixels).

SORD—Japan's most innovative computer corporation—introduces a full line of high-performance 68000-based computers and boards for the OEM/VAR market. Taking advantage of the incredibly high-speed (10MHz) 16/32 bit CPU and large address space (16MB), SORD has developed state-of-the-art computer systems to meet any OEM requirement from the low-cost (less than \$2000) new M68MX to the Unix-based, multi-user UNIBOX® with VME bus.

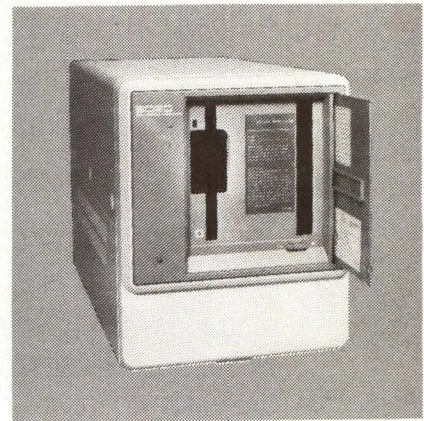

UNIBOX: Sample price - \$4,695

68010 CPU (10 MHz), upgradable to MC68020™. Standard 1MB Memory up to 16 MB. Either 5 or 12 VME Bus Slots. System V.



SORD COMPUTER CORPORATION, Tokyo, Japan (03) 281-8111

Sord Computer of America, Inc.

New York: 645 Fifth Avenue, N.Y., N.Y. 10022; 212-759-0140.

Chicago: 9 N. Main St., Lombard, IL 60148; 312-627-6056. Los Angeles: 723 W. 7th St., Los Angeles, CA 90017; 213-622-0244.

CIRCLE NO. 26 ON INQUIRY CARD

A no-risk offer for IBM PC-to-VAX users!

How to turn life's little shortcomings into a \$100 savings.

The PC to VAX world is populated with communications products that don't quite fill the bill. While each may have one nice feature or another, they also have their shortcomings. You've undoubtedly discovered a few yourself:

- VTERM's confusing setups.
- Crosstalk's missing printer port and delete key.
- SmarTerm 125's snail-paced screen repaint.
- XMODEM's unreliability.
- VTERM's part-time "hotkey."
- SmarTerm's misplaced keypad keys.

If you've found yourself frustrated by these deficiencies, or others, then it's time you move up to Polygon communications software. Because our terminal emulation and file-transfer products allow an IBM PC to perfectly emulate a wide variety of DEC terminals (including the VT240) and achieve easy, error-free data exchange.

\$100 Discount. 100% Guarantee.

For a limited time, we've added two "enhancements" to our communications products that are sure to make them even more popular with PC to VAX users:

Trade-up to poly-COM/220 or poly-COM/240 before December 31, 1985 and qualify for a \$100 discount from our regular prices. Plus get our

Guarantee that if you're not completely satisfied, you can return your purchase within 30 days for a 100% refund.

Make sure you're not shortchanged on this no-risk offer. Call us today for Trade-Up details.

314-576-7709.

DEC, VAX and VT are registered trademarks of Digital Equipment Corp. IBM and PC are registered trademarks of International Business Machines Corp. SmarTerm, VTERM, and Crosstalk are registered trademarks of Persoft, Inc., Coefficient Systems Corp., and Microstuf, Inc., respectively. Polygon, and poly- are registered trademarks of Polygon Associates, Inc.

 **polygon**[®]
The difference is experience.

© 1985 Polygon Associates, Inc.

OEMs... Is Your Input Strategy As Sound As Your CPU Strategy?



Computer users are demanding additional input devices from you. Key Tronic can help you meet the demand for these input devices, and minimize your development costs.

Key Tronic is integrating the most popular input devices into OEM keyboards. All processing is done in the keyboard and no additional system ports are required . . . using existing electronics saves money. Also, all input can be presented as a series

of key presses to assure compatibility with existing and future software.

Speech Recognition, Touch Pad, Mouse, Bar Code and Joy Disk are available to enhance your product with unique, value added benefits. Distinguish your product from the ordinary! Talk to your Key Tronic representative today.

A. Joy Disk — Four keys in one; rapid cursor control.

B. Touch Pad — Multi-purpose input device; programmable key pad, cursor control, drawing tablet.

C. Speech Recognition — Natural, language independent command entry. Hands free operation.

D. Mouse — Popular pointing and selecting tool.

E. Bar Code — Fast, accurate data capture.

“Feel the Key Tronic Touch”

key tronic
The Responsive Input Company

P.O. Box 14687 • Spokane, WA 99214 • USA
(509) 928-8000 • TWX 510-773-1885

CIRCLE NO. 28 ON INQUIRY CARD

**WE CAN
MAKE YOU
THE
BIGGEST
FASTEST
TOUGHEST
GUY
ON THE BUS
TODAY**

High Performance Disk, Tape and Communications Controllers, MULTIBUS™ and VMEbus.

When a company says it is going to make you the biggest, fastest, and toughest guy on the bus today, it better be a leader to start with. INTERPHASE Corporation is.

INTERPHASE has more than a decade of leadership in the design and manufacturing of sophisticated, high-speed, high-performance micro-computer products across a spectrum of bus architecture. MULTIBUS, VMEbus, even the IBM® PC bus.

OUR FIRSTS MAKE YOU FIRST

INTERPHASE has always been first-to-market to give you the competitive advantage:

- First MULTIBUS SMD disk controller.
- First MULTIBUS SMD controller with CACHING...our SMD 2190.
- First ESDI Winchester controller for ANY bus.
- First multi-tasking disk/tape controller for MULTIBUS...our Storager.™
- First MULTIBUS token passing network controller...our LNC 5180.
- First SMD controller for the IBM® PC...our Maverick.™
- First 32 bit VMEbus SMD disk controller...our V/SMD 3200.
- First full function, single board computer with built-in VMEbus expansion...our BASEboard.™
- AND NOW...the first 32 bit, VMEbus 1/2" Tape Controller...our V/Tape 3209.

EXCELLENCE BY DESIGN

Our Design Assistance Group will

provide immediate support as you first develop your system design, and work with you at every step to completion. And our Applications Engineering Group can save you valuable time and resources as you integrate our high-performance products into your systems.

OUR FAMILY OF PRODUCTS

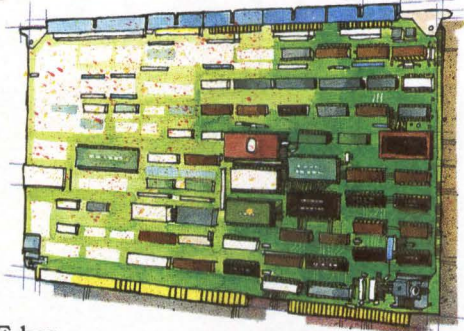

SMD 2190 MULTIBUS DISK CONTROLLER

Provides your Multibus system with the SMD disk controller power, flexibility and ease of use you need. The SMD 2190 offers

such benefits as UNIX™ optimized firmware, intelligent caching, 24 bit DMA addressing and Extended SMD data rates up to 20 megabits.

STORAGER MULTIBUS DISK / TAPE / FLOPPY CONTROLLER

Offers high-performance finesse with force for MULTIBUS on ST506, and ESDI Winchester disks, 1/4" tape drives and floppy disks drives. Storager's unique 68000 based Virtual Buffer Architecture speeds up your system by eliminating unnecessary disk latency and allowing concurrent disk / tape operation.

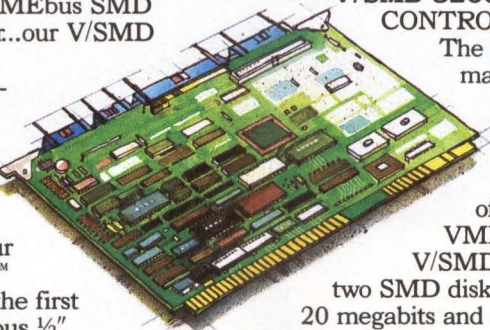

V/SMD 3200 VMEbus DISK CONTROLLER

The first high-performance SMD controller which allows you to exploit the full potential of the 32 bit VMEbus. The

V/SMD 3200 supports two SMD disk drives at up to 20 megabits and above. Imagine... multitasking 68000 power with Virtual Buffering for UNIX optimized intelligent caching, and zero latency reads and writes. The V/SMD 3200 is the essential

element to your VMEbus system performance.

V/TAPE 3209 VMEbus TAPE CONTROLLER

INTERPHASE's latest VMEbus product is a companion to the V/SMD 3200, and opens new VMEbus design options for you. The V/Tape will control up to 8, 9 track, 1/2 inch

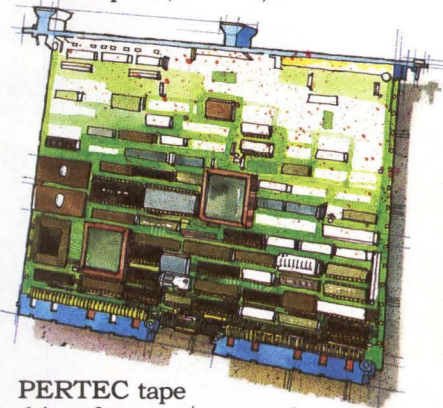

PERTEC tape drives for start / stop and streaming applications. The V/Tape also supports GCR as well as 1600 bpi operations and has ultra fast bus transfer rates at up to 200 ips. Advanced features like 128KB Tape Cache and an on-board 68000 family processor mean it can communicate directly with the INTERPHASE V/SMD 3200 disk controller...cutting your BUS usage in half.

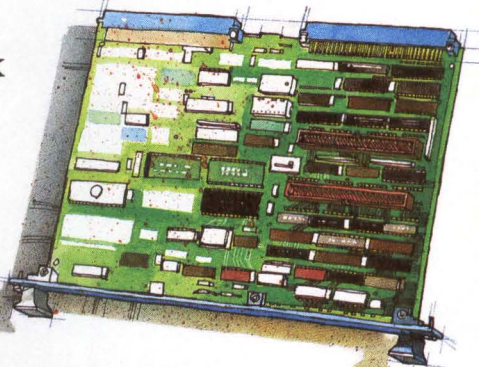

FIND OUT MORE: INTERPHASE is ready to help you get that project up and running...NOW. Call us today to get information about our NO RISK, First Time User Program. (214) 350-9000.



INTERPHASE
corporation

2925 Merrell Road • Dallas, Texas 75229 • Telex: 9109976245 NASDAQ-NMS: INPH

MULTIBUS is a trademark of INTEL Corp.
Storager, Maverick and BASEboard are trademarks of INTERPHASE Corporation.
IBM is a registered trademark of International Business Machines.
UNIX is a trademark of AT&T Bell Labs.

CIRCLE NO. 29 ON INQUIRY CARD

A SUPERIOR PERFORMER

INTRODUCING THE C2600.....THE 613 MEGABYTE, 8-INCH WINCHESTER DISK MEMORY FROM CENTURY DATA SYSTEMS

The C2600, the newest addition to our line of 8-inch Winchester disk memories, provides OEM's capacity, performance and quality in a compact, 8-inch package.

In fact, the C2600 is the highest capacity 8-inch disk memory currently available. Using an ESMD interface, the C2600 offers 613 megabytes of storage with a data transfer rate of 1.813 megabytes per second and an average access time of 15 milliseconds. The C2600 is equipped with eight 8-inch disks, 24 read/write heads and one dedicated servo head with 845 tracks per head. The compact size of the C2600 allows two units to be installed side-by-side in a 19-inch Retma rack. Using thin film technology and simplicity of design, the C2600 is the perfect disk memory for multi-user, multi-task environments.

The C2600 offers OEM's superior capacity and superior performance combined with proven Century Data Systems reliability. For more information contact: Century Data Systems, Product Marketing, 1270 N. Kraemer Blvd., Anaheim, CA 92806 (714) 632-7500.

 **Century Data Systems**
A Xerox Company



CIRCLE NO. 30 ON INQUIRY CARD

FEATURE HIGHLIGHTS

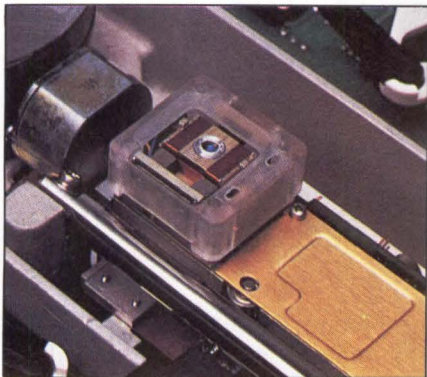

p. 68 Optic storage shining on

OPTICAL STORAGE SHINES ON THE HORIZON68

Optical storage technology has finally progressed from promise to product with over 25 companies competing. Our special report looks at the advantages of this new technology, as well as at the hurdles that remain in its way. The article examines the three dominant classes of optical disk drives—OROM, WORM and erasable—and includes a complete list of optical drive manufacturers, products and key specs.



p. 85 EP on the fast track

ELECTRONIC PUBLISHING LANDS ON THE DESKTOP85

This was a boom year for electronic publishing systems, and analysts are predicting a 35 percent annual growth rate over the next few years. One of the most exciting areas of EP is the emergence of low-cost (i.e., under \$10,000) systems that combine a microcomputer, a page scanner, a laser printer and EP software on a compact, desktop unit. These systems enable users to combine text, line art and graphics without resorting to a corporate art department or photo-offset printing. Our feature includes a complete list of EP manufacturers.

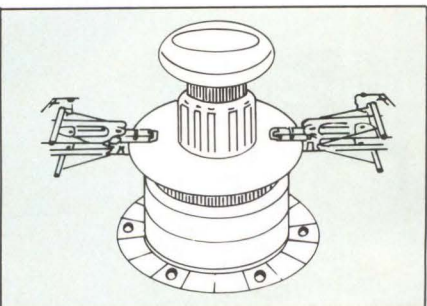

p. 95 Thin film vs. oxide media

THIN FILM CHALLENGES OXIDE MEDIA95

Improvements in magnetic media lie at the heart of advances in disk-drive performance. Standard oxide media, long the mainstay of the hard disk industry, is now being challenged by thin-film media, which includes plated, sputtered and plated with sputtered overcoat versions. The advantages and disadvantages of the various types are critical concerns to manufacturers of disk drives and to system integrators.

MINIS GAIN ON SUPERS WITH VECTOR PROCESSORS107

The high end of the mini-micro market is getting crowded with an array of new machines called superminicomputers, minisupercomputers and near-supercomputers. One company that claims a Cray-like architecture but superminicomputer prices is Convex Computer Corp. A close look at the architecture reveals a virtual-memory processor with 64-bit data paths and vector accumulators, 128M bytes of main memory and a 60-megaflop speed rating.

OPTICAL STORAGE SHINES ON THE HORIZON

Read-only, write-once and erasable optical disk drives promise voluminous economical data storage, but lack of media standards and software hinders market acceptance

Carl Warren, Western Editor

Using special gallium arsenide diode lasers, no bigger than a pencil eraser, on exotic rare-earth-based recording surfaces, optical disk drives promise to store from 40M bytes of data on 3½-inch disks to over 2G bytes on double-sided 12-inch disks.

Currently, three distinct classes of optical drives exist:

- Optical ROM (OROM)
- Write once, read many (WORM)
- Write many, read always (WMRA), erasable.

For the near future, OROM devices promise to be the most prominent. WORM drives, available in limited quantity, are still in their infancy and are about 18 to 24 months away from reaching full production. Erasable optical drives are at least four to five years away from full-scale production and market acceptability.

Both WORM and erasable optical disk drives suffer from similar problems. Specifically, even though the basic technology is developed, reliable media is still not available. Several questions regarding the interface and data format remain, and major uncertainties regarding control and

To read and write up to 2G bytes of data on a 12-inch, double-sided disk, the Alcatel Thomson Gigadisc uses a laser diode with focusing optics mounted on an optical actuator.

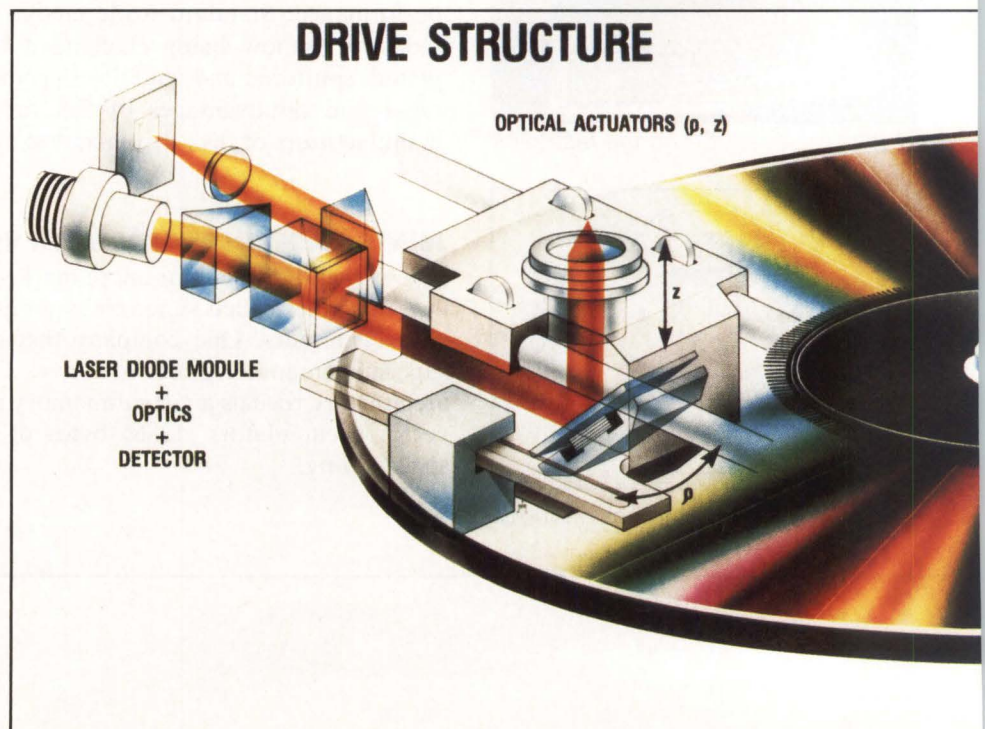

data-handling software exist.

Furthermore, no standards currently exist for data interchange. Interestingly, manufacturers of 12-inch optical products argue that standards aren't needed because their products are being used in niche markets that establish their own standards.

However, that doesn't appear to be the case with 5¼-inch WORM and erasable disk drives. Already, ANSI members are near agreement on a cartridge standard and are looking into the interchange problems as well. Many industry observers concur that 5¼-inch drives will probably enjoy standards well before 12-inch products. This is primarily because 5¼-inch products will be more pervasive than 12-inch drives due to lower cost.

Read only is here today

OROM devices contain prewritten data that can't be written over, much like a phonograph record. The data is mastered from video tape and is written with a laser beam onto a master disk, which in turn is used to press copies. Once pressed, the platters are covered with metal and put in a protective coating to minimize water absorption. The resulting disk contains any-

where from 500M bytes to 2G bytes of data—depending on diameter and number of data surfaces used.

One company, Reference Technology Inc., has developed a 12-inch, 2G-byte OROM system, called the DataDrive Series 2000, for publishing archive information. In addition, the company is an OEM to Hitachi America Ltd. for a 5¼-inch drive that it bundles in the DataDrive 500, a 550M-byte system.

Reference Technology has also developed the necessary software including a keyed information-retrieval package to assist in writing application software, a full text-retrieval package and a complete file-management system. In addition, the company provides a data-preparation service to prepare data for etching onto the optical disks.

Other companies entering the OROM and data-preparation arena include Hitachi, Sony Corp., Toshiba America Ltd. and Victor Co. of Japan (JVC Brand).

WORM blocks need protection

Even though OROM drives do offer publishers a low-cost method of distributing information (typically about \$20,000 for mastering a disk and

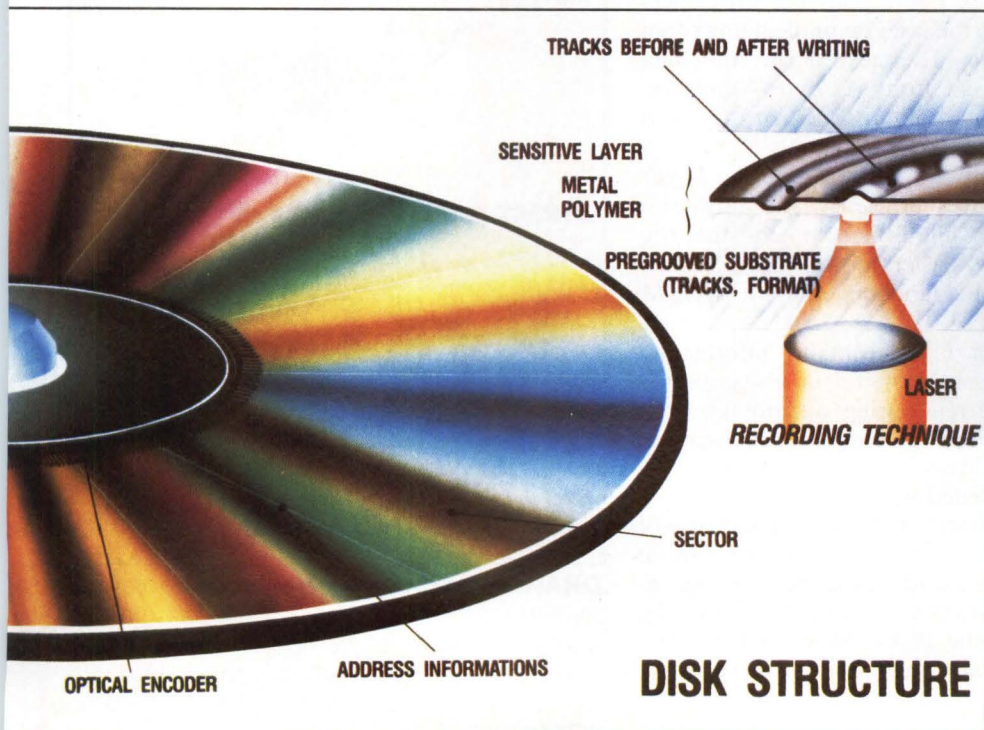

Most optical disk media, such as Alcatel Thomson's Gigadisc, store data in the form of bubbles on the medium's pregrooved surface. A write pulse from the 20-mW laser is absorbed by the sensitive recording layer, and the heat generated decomposes a small part of the adjacent polymer. The resulting gas pressure deforms the recording layer into a bubble, which appears more reflective than the adjacent area and is thus able to be read by a 1-mW laser.

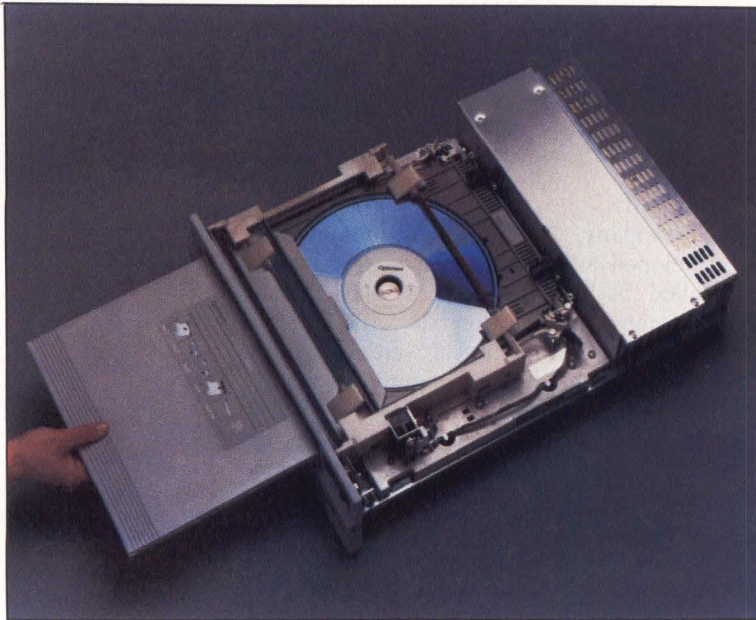

Storing 1G byte

—or about 100,000 pages of typewritten information—on a single platter, the Optimem 1000 WORM drive uses a 12-inch cartridge and a SCSI interface.

\$6 per copy), optical disk drive manufacturers see the need for WORM and, eventually, erasable capability.

WORM drives are similar in some respects to OROM devices in that, once written, the data can't be changed. However, several complications exist with WORM drives.

For example, data areas have to be protected. As a result, data blocks are provided with a write-protect block that signals the drive electronics to not turn the laser on until an unwritten block is available. The next block, the data block, ranges in size from 512 bytes—the standard sector size used on an IBM Corp. PC—to 1,024 bytes.

Some manufacturers believe that the larger sector size improves efficiency and facilitates error correction, while others contend that the 512-byte sector is easier to work with. Thus, both sizes can be found on different WORM drives.

The final data block contains information about the previously written data. For example, if an error occurred during a write cycle, a pointer to the next usable block is written. Additionally, 16 bytes are used to point to new data that is associated with the record.

Further complicating the drive is the choice of media format. Manufacturers use either a spiral track, which is similar to tape format, or concentric ring tracks, which more closely resemble the layout on magnetic disks. Most optical drive manufacturers claim that their drives can use either format.

Laserdrive Ltd., a manufacturer of 5¼-inch

WORM drives, uses the spiral tracking method. The company targets low-end applications, such as storage for computers like the Apple Computer Inc. Macintosh, the Atari Inc. ST series and Commodore Business Machines Inc.'s Amiga. Thus, speedy access times aren't a primary consideration.

Designers can use either constant linear velocity (CLV) or constant angular velocity (CAV) technology to maximize drive performance. In the former, the recording density remains constant over the entire disk; thus the disk spins slower at the outside tracks than at the inner. In contrast, a CAV drive maintains a constant revolutions-per-minute rate but the densities are higher at the inner tracks. The CLV method yields high capacities but is expensive because of hardware and software overheads. The CAV method comes closer to the price/performance ratio that most system integrators expect.

The lack of available media is causing drive manufacturers difficulty. Although companies such as 3M, Maxell Corp. of America and Plasmon Data Systems are manufacturing

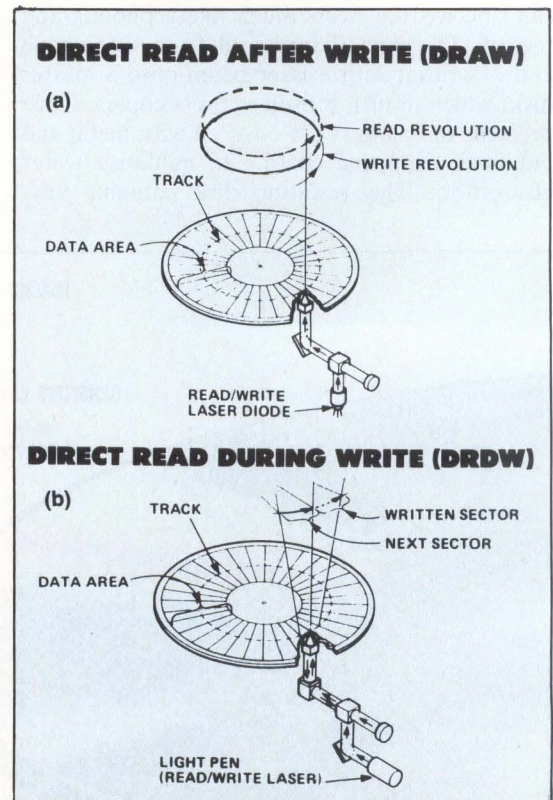

DRAW recording (a) requires a full rotation to inspect the previously written data. In contrast, **DRDW recording (b)** immediately checks to see if the data is correct, thus removing the necessity of an extra rotation, which speeds write operations.

Introducing The Gold Quadboard.[®] "The hardware equivalent of 1-2-3."

Computer Buyer's Guide and Handbook, September, 1985

Quadram[®] introduces a new standard in PC enhancements: the Gold Quadboard, the board people are calling "the hardware equivalent of 1-2-3!" Like 1-2-3[®], the Gold Quadboard combines three powerful products into one to deliver the most value for your dollar and conserve slot space.

With the Gold Quadboard you get: 1) A multifunction board complete with RAM

Use Keysaver to protect your data from power outages or misstruck keys, or create keyboard macros to help automate your work. Keysaver even comes with a special security feature that protects your system from unauthorized access.

But best of all you get all this in just *one expansion slot*. And when you add up the cost of a separate multifunction board, color graphics board, and back-up utility, you'll find

that Gold Quadboard saves you money, too.

The Gold Quadboard is 100% PC-compatible,

built for reliability, and engineered for performance. No other multifunction board gives you more value for the money. To find out more, visit the Quadram dealer nearest you. Or contact us at One Quad Way, Norcross, Georgia 30093-1308; (404) 923-6666.

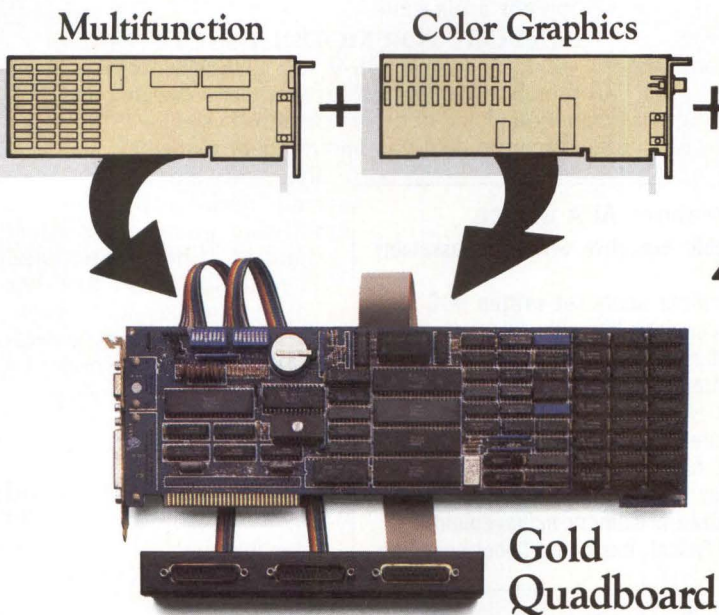

expansion and the ports you need to increase system power; 2) An IBM[®]-compatible color graphics adapter that supports brilliant color graphics displays; and 3) Keysaver, the unique battery-powered back-up system that lets you store over 4,000 keystrokes of input data on the Gold Quadboard.

SPECIFICATIONS

100% IBM PC-compatible • Memory expansion to 640K using 64K or 256K chips • IBM-compatible color RGB and composite video output • One parallel printer port • One serial communications port • Optional second serial and parallel ports • I/O Bracket for easy cable access • Clock/Calendar • Keysaver • QuadMaster[®] III software • PolyWindows DeskPlus[™] desk top management software • QuadPaint[™] graphics software • Extended 5 year warranty (for 384K versions and up/2 year warranty with less than 384K)

Lotus 1-2-3 is a registered trademark of Lotus Development Corp. IBM is a registered trademark of International Business Machines, Inc. Gold Quadboard, QuadMaster, Quadram, and Quadram logo are registered trademarks of Quadram Corp. QuadPaint and KeySaver are trademarks of Quadram Corp. PolyWindows DeskPlus is a trademark of Polytron, Inc.

© 1985 Quadram Corporation. All Rights Reserved.

CIRCLE NO. 31 ON INQUIRY CARD

QUADRAM
An Intelligent Systems Company



Only Microware's OS-9 Operating System Covers the Entire 68000 Spectrum

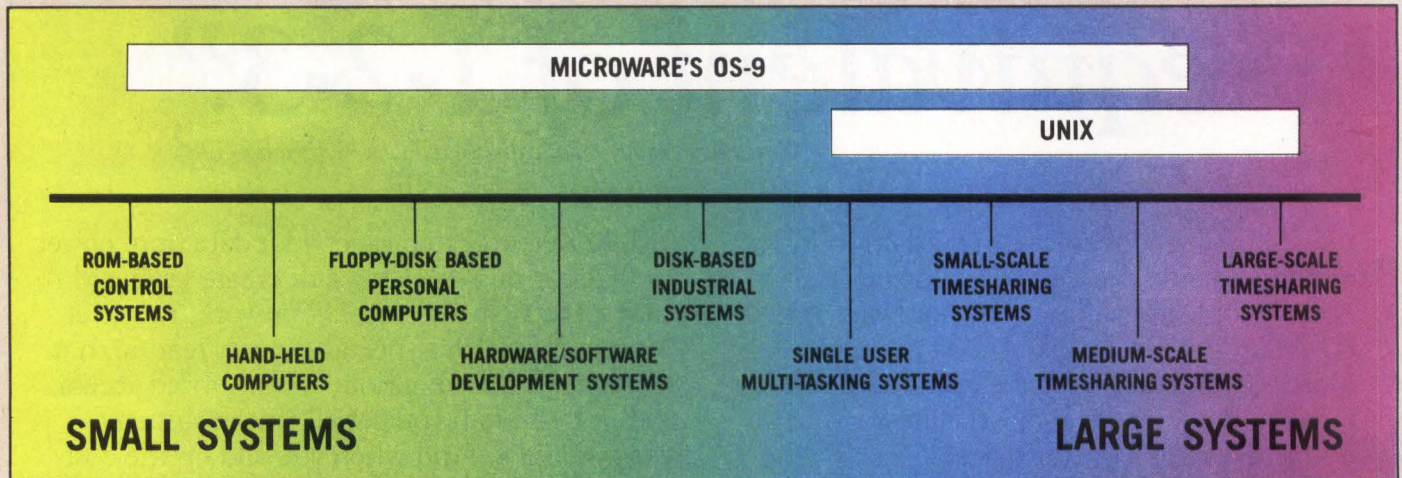

Is complicated software and expensive hardware keeping you back from Unix? Look into OS-9, the operating system from Microware that gives 68000 systems a Unix-style environment with much less overhead and complexity.

OS-9 is versatile, inexpensive, and delivers outstanding performance on any size system. The OS-9 executive is

much smaller and far more efficient than Unix because it's written in fast, compact assembly language, making it ideal for critical real-time applications. OS-9 can run on a broad range of 8 to 32 bit systems based on the 68000 or 6809 family MPUs from ROM-based industrial controllers up to large multiuser systems.

OS-9'S OUTSTANDING C COMPILER IS YOUR BRIDGE TO UNIX

Microware's C compiler technology is another OS-9 advantage. The compiler produces extremely fast, compact, and ROMable code. You can easily develop and port system or application software back and forth to standard Unix systems. Cross-compiler versions for

VAX and PDP-11 make coordinated Unix/OS-9 software development a pleasure.

SUPPORT FOR MODULAR SOFTWARE — AN OS-9 EXCLUSIVE

Comprehensive support for modular software puts OS-9 a generation ahead of other operating systems. It multiplies programmer productivity and memory efficiency. Applica-

tion software can be built from individually testable software modules including standard "library" modules. The modular structure lets you customize and reconfigure OS-9 for specific hardware easily and quickly.

A SYSTEM WITH A PROVEN TRACK RECORD

Once an underground classic, OS-9 is now a solid hit. Since 1980 OS-9 has been ported to over a hundred 6809 and 68000

systems under license to some of the biggest names in the business. OS-9 has been imbedded in numerous consumer, industrial, and OEM products, and is supported by many independent software suppliers.

Key OS-9 Features At A Glance

- Compact (16K) ROMable executive written in assembly language
- User "shell" and complete utility set written in C
- C-source code level compatibility with Unix
- Full Multitasking/multiuser capabilities
- Modular design - extremely easy to adapt, modify, or expand
- Unix-type tree structured file system
- Rugged "crash-proof" file structure with record locking
- Works well with floppy disk or ROM-based systems
- Uses hardware or software memory management
- High performance C, Pascal, Basic and Cobol compilers

microware[®]
OS-9[™]

MICROWARE SYSTEMS CORPORATION
1866 NW 114th Street
Des Moines, Iowa 50322
Phone 515-224-1929
Telex 910-520-2535

Microware Japan, Ltd
41-19 Honcho 4 Chome Funabashi City
Chiba 273, Japan
Phone 0474-22-1747
Telex 298-3472

OS-9 is a trademark of Microware and Motorola. Unix is a trademark of Bell Labs.

CIRCLE NO. 32 ON INQUIRY CARD

WORM, OROM and, to a limited degree, erasable media, supplies aren't large and bit-error rates are still in the 10^{-4} range (which, however, can be corrected using error-correction code schemes). Additionally, WORM media can be preformatted and scanned to map defect areas. This map is a list of bad, or unusable, sectors. The controller uses the map information to avoid bad sectors and tracks.

Typically, optical recording uses a precisely focused laser beam to burn tiny pits on a recording platter. The presence or absence of pits, when they rapidly pass under a light beam in playback mode, triggers a photoelectric receptor that translates that presence or absence to electrical signals, which are then transformed into digital data. This technique is used by WORM drive manufacturers.

However, this technology does have drawbacks. Specifically, the pits don't always have precise edges, thus fouling the readback system and presenting non-correctable errors. Moreover, the ragged edges cause a poor carrier-to-noise ratio (CNR).

One method of manufacturing media, developed by 3M, that improves reliability is a blistering or bubble-forming technique. With this method, the laser burst raises the temperature of a spot on the media to about 2,000 C, causing the lower layer to vaporize and forcing the covering layer up into a bubble, or blister. The blister has no ragged edges to contribute to surface noise. The readback system senses scattered light from the bubble, which denotes a written bit.

Companies such as Eastman Kodak Co. are also developing optical media. Kodak puts a

Stages in creating WORM media

In a write-once, read-many (WORM) drive that uses an ablative-pit recording method, the media is pre-grooved and formatted with clock information (a), and then is burned in, appearing as a hole (b). As shown (c), clock information appears as a series of bubbles (left) and the data as fringed holes (right).

magnetic disks—except that each sector begins with a write-protect field to prevent overwriting and destroying existing data. The write-protect fields are followed by the user-data field and the write-complete field. The latter points to either a new sector if an error was encountered during writing, or to a new data record if the record was updated.

The data is arranged in sectors (d)—much like

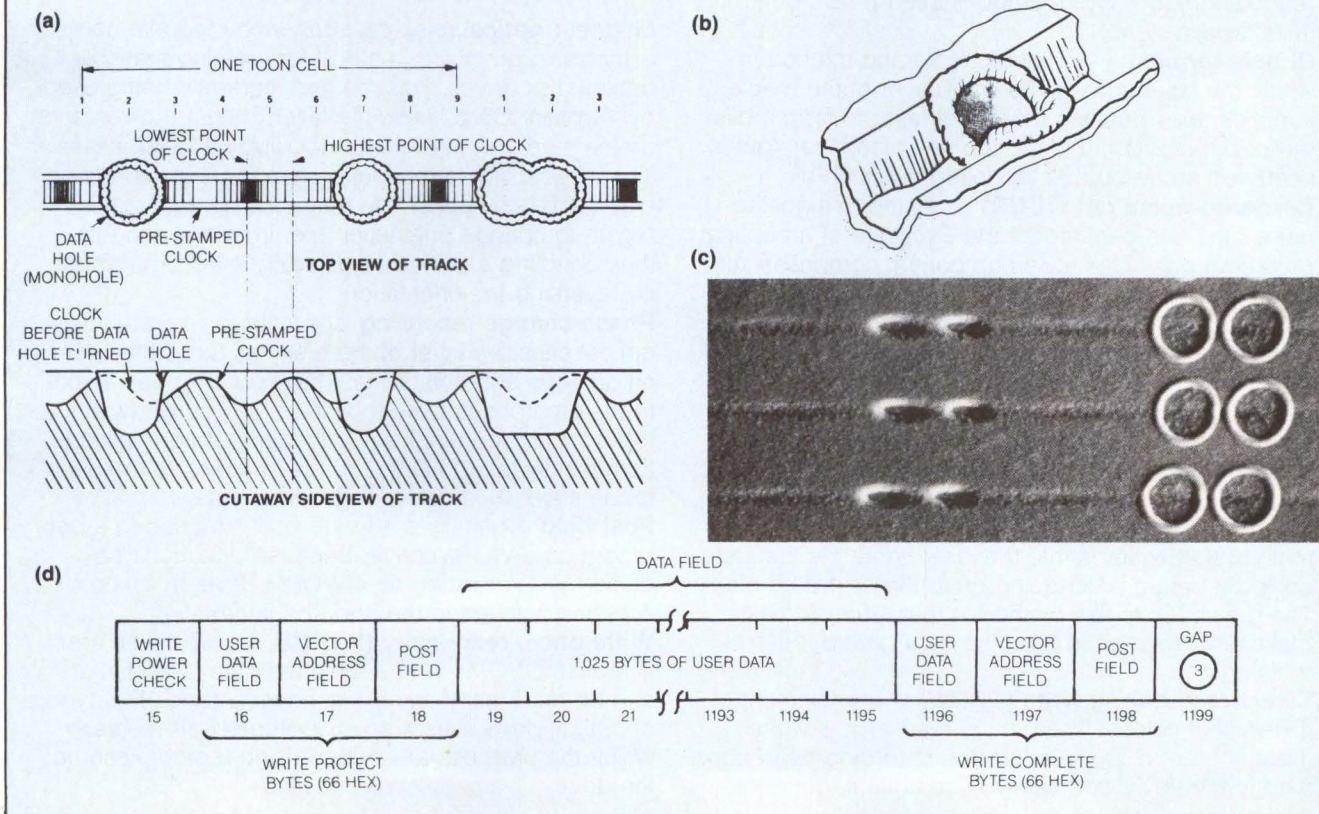

protective polymer coating over the sensitive recording layer. And, like 3M, the company is exploring a variety of recording methods such as ablative, blister and phase change.

Phase-change recording uses a technique whereby the physical state of the material is changed from a crystalline to an amorphous state to denote a written bit. Reversing the process to change back to crystalline erases the data. Although Sony has more than 10 years of experimentation with phase-change technology, reliable data on media life is still sketchy. It is believed that it is somewhere between three to

five years, and possibly 10, depending on how the media is stored. One disadvantage to phase-change media is that it is temperature sensitive and reverts back to a crystalline state at about 100 C.

Magneto-optical media is currently viewed with favor by erasable drive manufacturers. With this media, no physical change takes place in the crystal structure. Rather, magneto-optical disks use high-coercivity media (2,000 to 3,000 Oe) with the magnetic domains in vertical orientation. The laser heats a spot, which lowers the media's coercivity and makes it susceptible to

Glossary of key optical technology terms

Ablative-pit forming is an optical recording method in which the data bit is written by forming a pit, or depression, in the sensitive recording layer of the disk by removing, or ablating, surface material. This is achieved by the laser literally burning a pit in the surface. The difference in surface reflectivity caused by the pitted area is then read as a data bit in readback mode.

Alloying is an optical recording method in which two chemically compatible film layers are heated at specific points by a laser to create an alloyed layer. The difference in reflectivity is then registered as a bit in readback mode. This method is used by DOCdata NV in its tape system.

Bubble forming is an optical recording method in which the laser causes the underlayer of the media to vaporize, thus pushing the upper layer to form a blister, or bubble. On reading, the reflected laser light is scattered at the bubble, denoting a written bit.

Carrier-to-noise ratio (CNR) is related to signal-to-noise ratio and can impact the error rate of an optical recording disk. The noise component comprises substrate inconsistencies, as well as amplifier and laser noise. Typically, for 100 kHz bandwidth of carrier, noise of about 70 microvolts magnitude is read. Thus the optimal solution to CNR problems is to pick a bandwidth somewhere above the associated noise bandwidth that is wide enough to accommodate the data stream, yet narrow enough to avoid generating its own noise.

Direct read after write (DRAW) is an error-detection method that ensures that the laser wrote the last data correctly before proceeding on to the next data block. The drawback to this method is that the disk must make a full rotation to read the data before it can write again.

Direct read during write (DRDW) is a refinement of DRAW technology. The data is read as it is written. Thus, if an error is detected, the recording head can skip to the next good sector. The advantage to this

error-detection method is speed because it doesn't require a full disk rotation, as does the DRAW method. The disadvantage is that it requires more sophisticated and expensive light-path technology than that used on DRAW devices.

Optical ROM (OROM) is a type of optical disk technology in which the information (digital data and images) is laser-etched onto the surface of a master disk that is used to press copies. A laser optical system within the drive reads the data. This method of optical storage is currently the most pervasive and is used with digital music in the form of compact disks (CD).

Magneto optical, also called thermo-magneto optic, is the most promising method for creating erasable optical disk drives. This method, currently being used by Verbatim Corp., uses the laser to heat a given spot on the media, which lowers coercivity and increases its susceptibility to magnetic change. A surrounding bias field then causes the magnetic domain in this region to change orientation (i.e. from down to up), thus denoting a written bit. Erasing is accomplished by reversing the orientation.

Phase-change recording is a method whereby the optical sensitive layer of the disk has two states: amorphous and crystalline. The laser changes a spot to the amorphous state to write a bit. The drawback to this optical recording method is temperature instability: typically, at 100 C the media switches to the crystalline state, thus destroying written data.

Post field is usually a 16-byte field attached to a data record on a WORM drive. Because data can't be erased or overwritten on a WORM drive, this field contains pointers to the updated information.

Write-once, read-many (WORM) optical drives are similar to OROMs in that once the data is written, it can be read many times, but never erased. This type of optical drive uses a special pregrooved media in which the data bits are written using a diode laser in the drive.

OPTICAL DRIVE MANUFACTURERS

Manufacturer	Model	Type: OROM, WORM, erasable	Capacity (G bytes)	Interface	Surfaces	Data rate	Disk size (inches)	Notes
Alcatel Thomson Gigadisc Inc.	GM 1001	WORM	2	SCSI	2	1.5M BPS at 480 rpm	12	shipping
Cherokee Data Systems	Pathfinder	WORM	.3	ESDI	1	N/A	5 1/4	samples early '86
Daisar Corp.	unnamed	erasable	.7	ESDI/SCSI	1	N/A	8	plan models by late '86; media developed by Kerdix and Nakamichi
Fujitsu Ltd.	F6441A1	WORM	1.3	SCSI	1	N/A	12	drive available in Japan
	F6441B1	WORM	1.3	similar to ESMD	1	783K BPS	12	drive available only in Japan
Hitachi America Inc.	OC301-1	WORM	1.3	IEEE-488	1	400K BPS at 600 rpm	12	shipping
	OC302-2	WORM	1.3	IEEE-488	2	400K BPS at 600 rpm	12	shipping
	CDR-1502	OROM	.552	8-bit parallel	1	176K BPS	5 1/4	shipping
Information Storage Inc.	525 WC	WORM	.1	ESDI	1	2.5M bps at 1,800 rpm; can read OROM disks	5 1/4	shipping
Laserdrive Ltd.	LD33	WORM	.23	ESDI/SCSI	1	1.25M bps at 900 rpm	5 1/4	under development, due mid '86; spiral track format without sectors; aimed at low-end systems; may move to 1.6 micron track pitch
Nippon Columbia Co. Ltd.	Denon CD-ROM	OROM	.6	8-bit parallel	1	153K BPS	5 1/4	shipping
Nissei Sangyo America	OD-301	WORM	2.6	SCSI	2	N/A	12	sample quantities
	CDR-2500S	OROM	.552	SCSI	1	N/A	5 1/4	sample quantities; WORM version in mid '86
North American Philips Corp.	CM-100	OROM	.6	8-bit parallel	1	1.41M bps	5 1/4	shipping
Optical Storage International	Laserdrive 1200	WORM	2	SCSI	2	1.5M BPS at 480 rpm	12	shipping
Optimen	Model 1000	WORM	1	SCSI	1	5M bps	12	shipping; 5 1/4-inch model by mid '86
Optotech Inc.	Model 5984	WORM	.488	proprietary; ESDI/SCSI	2	2.2M bps at 1,200 rpm	5 1/4	shipping; provides development software for file management
Reference Technology Inc.	Datadrive 500	OROM	.55	IBM PC parallel	1	150K BPS	5 1/4	shipping
	Datadrive 2000	OROM	2	SCSI	2	247K bps	12	shipping
Sony Corp. of America	CDU-1	OROM	.54	8-bit parallel SCSI	1	150K BPS	5 1/4	uses CLV; 200 to 530 rpm
	WDA-2000	WORM	1	SCSI	2	N/A	8	shipping in small quantities
	WDA-3000	WORM	2/3.2	SCSI	2	N/A	12	shipping in small quantities
Toshiba America Inc.	DF-050	WORM	.5	SCSI	2	2.5M bps at 900 rpm	5 1/4	shipping in Japan
	DF-0450	WORM	3.6	IEEE-488	2	2.5M bps at 900 rpm	12	shipping in Japan
Verbatim Corp.	prototype	erasable	.04	undefined	1	N/A	3 1/2	prototype planned for '87
Victor Co. of Japan	JVC brand model	OROM	.7	N/A	1	N/A	5 1/4	expected to ship early '86

Key:
 OROM = optical read only memory WORM = write once, read many BPS = bytes per second bps = bits per second



To produce optical media, Plasmon Data Systems uses a two-stage process. The first is to create the "moth eye" structure, the grooves and the preformat information. The subsequent step is replication, including molding and metallizing the substrate disk.

magnetic reorientation by a surrounding bias field. Bits are erased using the same process.

Magneto-optical media is easier to make because manufacturers can borrow from methods used in creating sputtered vertical media, as well as processes developed for WORM media. Moreover, bit-error rates are closer to those of magnetic media.

One company currently developing magneto-optical drives is Verbatim Corp., which this past summer demonstrated a 3½-inch, 40M-byte model. Similarly, start-up Daisar Corp. is developing an 8-inch, 700M-byte version that it plans to begin sampling by the end of 1986. The Daisar drive uses media developed by sister company Kerdix Inc., who is borrowing technology developed by Nakamichi U.S.A. Corp. The media was originally designed for erasable-media audio systems.

ECC improves reliability

Of great concern to drive manufacturers and system integrators is the error and defect handling on optical drives. The method used by Optical Storage International (OSI) centers on a direct-read-during-write (DRDW) approach to detect errors. This technique reads back the data the moment it is written and compares it to the data in the write buffer. If an error exists, a new section of disk is chosen. This approach differs from so-called direct-read-after-write (DRAW) drives, which read after the writing is performed, thus necessitating a full rotation of the drive before a new area can be written.

But most drives perform error handling after the fact—on read back. When an error is detected, the system attempts to correct it using a polynomial factor that is set to correct a given number of errors over a specified burst period. In addition, the ECC circuitry and associated

firmware must account for the interleave factor, or staggering of sectors, as well as loss of signal synchronization.

Reed-Solomon codes are capable of correcting single or multiple errors. An implementation of this in silicon has been developed by Data Systems Technology. The chip uses an interleaved Reed-Solomon code that can handle up to three interleaves, or, by using several chips in parallel, an interleave factor of 3^N , where N is the number of chips used. Moreover, the chip can accommodate up to 669 bytes per physical sector, or 669^N with additional chips.

Depending on the microprocessor used and the number of errors encountered, error-correction times vary. For a 12-MHz, 8-bit processor encountering eight errors, the typical correction time is 7.6 msec. Implemented with full buffer management and an enhanced small device interface controller or a small computer systems interface, error-correction times drop, and raw bit error rates decrease from 10^{-4} to an acceptable 10^{-12} on optical drives. Although the correction time may appear excessive, using an intelligent interface hides the operation from the user; thus corrected data is delivered in about the same time as is non-corrected data.

Interface is critical

Regardless of the type of optical drive, interfacing is the prime concern to system integrators.

Drive manufacturers are considering using either ESDI or SCSI. There is some thought given to an ESDI/SCSI combination. This latter possibility has merit because ESDI is a device interface and SCSI is a system interface.

The intended goal of an interface is to make the drive characteristics transparent to the system and to the user. Thus, all interface approaches remove most integration burdens from the system integrator. For example, it is expected that with ESDI, existing Winchester controllers can be used in an optical system by changing the ROM code. SCSI can be similarly employed.

Several manufacturers, as shown in the accompanying table, are already using SCSI. On the other hand, some manufacturers, such as Information Storage Inc. (ISI), opt for ESDI.

The advantage of SCSI over ESDI is that the drive can be easily matched to a system via a host adapter rather than a complete controller. Optimum, for one, uses a SCSI controller with bit-slice processors. Included on the controller is an interleaved Reed-Solomon code for error detection and correction. The Optimum SCSI controller also implements a 4K-byte buffer (four sectors), which allows a continuous flow of data.

The choice line of disk drives now gives you more choices.

Panasonic®

The Panasonic line of disk drives is now better than ever. We have more disk drives to choose from, with exceptional Panasonic quality, reliability and performance. Choose our 5¼" disk drives or our 3½" disk drives. Either way you'll be glad you chose Panasonic.

With Panasonic disk drives, you not only get our years of past expertise, you also get our present and future commitment to the industry. Panasonic 5¼" disk drives have been manufactured by our parent company, Matsushita Electric, for years. In fact, we even have patent rights to produce double-sided disk drives. And Matsushita's modern disk drive factory is already developing even higher density floppy disk drives.

You'll be assured of continued support with Panasonic, because we're establishing a new dedicated sales and service organization. And you can count on our disk drives to be ready when you are. In a couple of weeks...or several years.

So, if you need a 1 Mbyte microfloppy disk drive, a 500 Kbyte or 1.6 Mbyte, mini-floppy disk drive...come to Panasonic. Because, at Panasonic, when we put our name on a product, we put our name on the line.

When you're ready to make a choice, just contact: Panasonic Industrial Company, Memory Systems Division, 1731 Technology Drive, San Jose, CA 95110. (408) 294-5888. Or any Hamilton-Avnet location.

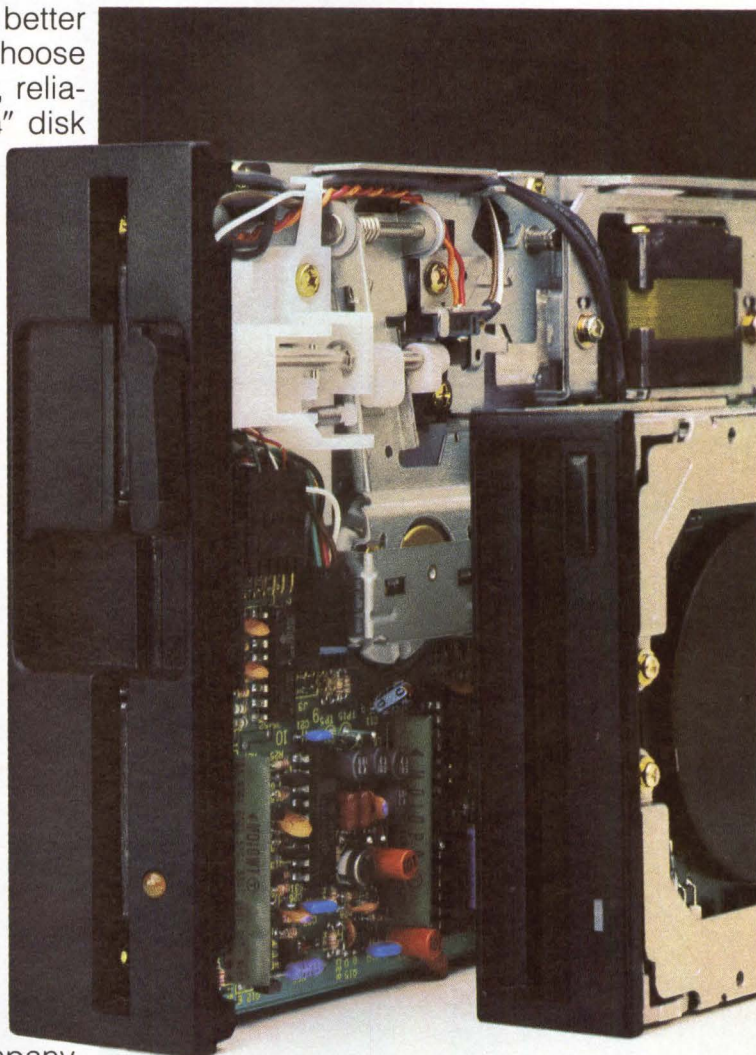

Panasonic
Industrial Company

Take the credit for our work.

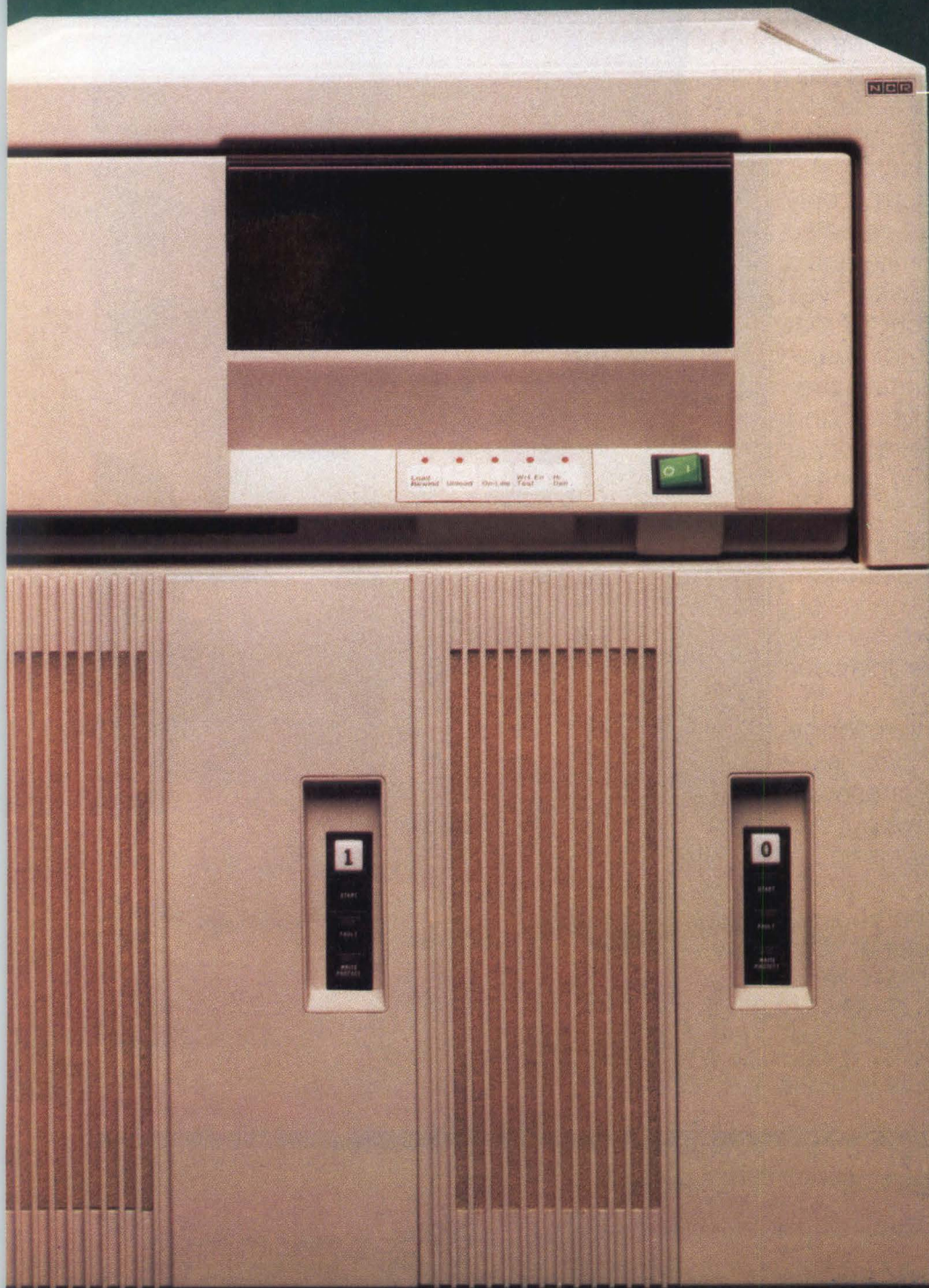

Put your name on full SCSI disk and tape subsystems. Qualified. Certified. And delivered. SCSI simplifies the task of integrating new peripherals into your system. And now you can offer SCSI subsystems from NCR bearing your name. The products of leading-edge VLSI controller design, exhaustive drive qualification and the most rigorous testing and advanced manufacturing procedures in the industry. Fully certified—by UL, CSA and VDE.

You can't duplicate NCR's resources and SCSI expertise. But you can buy them. For more information, call NCR at 1-800-325-SCSI.

NCR offers SCSI subsystems from tabletop models to deskside units.

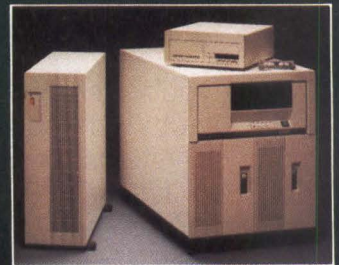

OEM Products/P.O. Box 20077
Wichita, KS 67208



CIRCLE NO. 34 ON INQUIRY CARD

OPTICAL STORAGE

ESDI advantages are similar to those of SCSI, but it isn't as well defined for optical implementations as is SCSI. It is expected that by mid-1986 the specification will be fully defined and numerous semiconductor companies will be making ESDI chip sets.

An important aspect of the SCSI approach, as opposed to device- and host-specific controllers, is that many of the tough technical details of the drive are transparent to the user/integrator. The system integrator thus has to deal only with the data-transfer rate, which can be configured either for 5M bits per second or 10M bps.

Software remains a problem

Most operating systems don't recognize devices with 15,000 tracks per inch and the need to turn lasers on and off in critical time patterns. For OROM devices, the problem isn't as critical as in WORM or erasable devices. The latter two require precise timing and control over the laser and the spindle speed. In addition, WORM drive

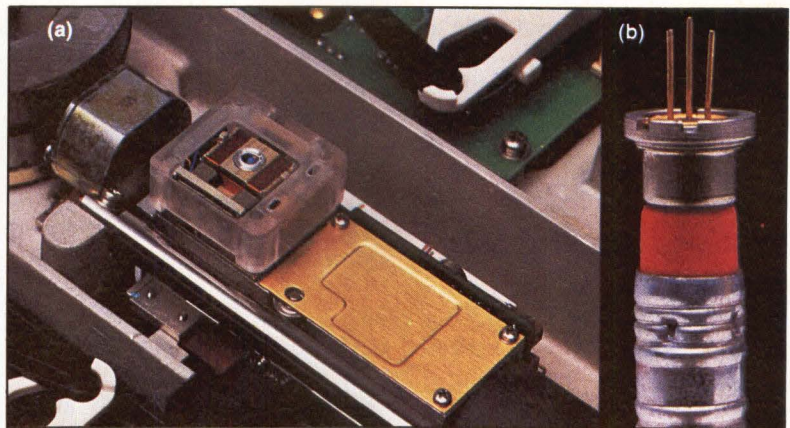

Encased in a light-path housing that mounts on the head actuator (a), the semiconductor diode laser used in the OSI LaserDrive is no bigger than a pencil eraser (b), but is capable of generating 20 mW of laser power to create pits in the medium surface.

Companies mentioned in this article

**Alcatel Thomson
Gigadisc Inc.**
16-18 Depot St.
Franklin, Mass. 02038
(617) 528-8890
Circle 370

Cherokee Data Systems
1880 Flat Iron Court
Boulder, Colo. 80301
(303) 449-8850
Circle 371

Daisar Corp.
Suite 320
3300 Mitchell Lane
Boulder, Colo. 80301
(303) 443-4634
Circle 372

**Data
Systems Technology**
Unit 102
1047 E. Ninth Ave.
Broomfield, Colo. 80020
(303) 466-5228
Circle 373

DOCdata NV
P.O. Box 1021 5900
BA Venlo, Netherlands
(077)-44100
Circle 374

Eastman Kodak Co.
343 State St.
Rochester, N.Y. 14650
(716) 724-4664
Circle 375

Fujitsu Ltd.
6-1 Marunouchi 2-chome
Chiyoda-ku
Tokyo, 100, Japan
Circle 376

Guaranteed Software
10044 S. De Anza Blvd.
Cupertino, Calif. 95014
(408) 973-8565
Circle 377

Hitachi America Ltd.
950 Elm Ave.
San Bruno, Calif.
94066
(415) 872-1902
Circle 378

Information Storage Inc.
2768 Janitell Road
Colorado Springs, Colo.
80906
(303) 579-0460
Circle 379

Kerdix Inc.
Suite 320
3300 Mitchell Lane
Boulder, Colo. 80301
(303) 443-4634
Circle 380

Laserdrive Ltd.
1101 Space Park Drive
Santa Clara, Calif.
95054
(408) 727-8576
Circle 381

**Maxell Corp.
of America**
60 Oxford Drive
Moonachie, N.J. 07074
(201) 440-8020
Circle 382

Nakamichi U.S.A. Corp.
19701 S. Vermont Ave.
Torrance, Calif. 90502
(213) 538-8150
Circle 383

Nissel Sangyo America
460 E. Middlefield Rd.
Mountain View, Calif.
94043
(415) 969-1100
Circle 384

**Optical Storage
International**
3333 Scott Blvd.
P.O. Box 58063
Santa Clara, Calif.
95052
(408) 496-3236
Circle 385

Optimem
435 Oakmead Parkway
Sunnyvale, Calif. 94086
(408) 737-7373
Circle 386

Optotech Inc.
Suite 109
770 Wooten Road
Colorado Springs, Colo.
80915
(303) 570-7500
Circle 387

Plasmon Data Systems
25736 Adams Road
Los Gatos, Calif. 95030
(408) 353-4464
Circle 388

Reference Technology Inc.
1832 N. 55th St.
Boulder, Colo. 80301
(303) 449-4157
Circle 389

Sony Corp. of America
Data Products
Component Products
Division
1359 Old Oakland Road
San Jose, Calif. 95112
(408) 280-0111
Circle 390

3M
Memory
Technologies Group
220 3M Center
St. Paul, Minn. 55144
(612) 733-8317
Circle 391

Toshiba America Inc.
Disk Products Division
Suite 103
3910 Freedom Circle
Santa Clara, Calif.
95054
(408) 727-3939
Circle 392

Verbatim Corp.
323 Soquel Way
P.O. Box 3477
Sunnyvale, Calif.
94086
(408) 245-4400
Circle 393

**Victor Co. of Japan
(JVC Brand)**
4-1 Nihon Bashi-Honcho
Chuo-ku
Tokyo, 103, Japan
(03) 241-7811
Circle 394

Currently, none of the software houses that develop operating systems are providing optical disk support.

software must detect that a region has been previously written, and recognize post fields to locate pointers to new data. Furthermore, full file management and information retrieval have to be built in.

Because companies like Information Storage and Optotech Inc. are offering 5¼-inch WORM drives for the IBM PC/XT, they have developed supporting software that operates with MS-DOS.

ISI, for example, has ISDOS, which is a sophisticated device driver that installs in the Configure system file (CONFIG.SYS) on the PC. This file is used by MS-DOS to attach foreign devices such as optical disk drivers to the system.

One function of ISDOS allows mounting of the data file. This is necessary due to the limitations of MS-DOS, which cannot request data beyond a 32M-byte limit. Moreover, the MOUNT function also recognizes most recent versions of files, thus removing the need for the user to specify which files are new.

Similarly, Optotech offers an IBM PC support package that provides such disk I/O primitives as

open, close, read, write and seek. In addition, it allows for error- or fault-reporting of the optical system. This package assists system integrators in developing software that uses the optical disk.

OSI is also taking the full system approach, offering a complete range of system-level and application-development software. Additionally, because the OSI LaserDrive 1200 employs a SCSI interface/controller, the company has implemented a rich set of SCSI commands, including message system, reserve and release, and logical unit and block address functions. The OSI system is the first full implementation of the SCSI intelligent interface and command set.

Currently, none of the software houses that develop operating systems are providing optical disk support. However, companies such as start-up Guaranteed Software, along with the previously mentioned manufacturers, are developing file-handling products for, in most cases, the IBM PC. □

Interest Quotient (Circle One)
High 486 Medium 487 Low 488

Concurrent™ PC DOS Works For These People



"PhoneXpress™, our voice messaging product, needs the powerful multi-tasking environment that Concurrent PC DOS offers. Also, our programmers love it, they can be compiling in one window and switch into an editor which increases productivity."
Dennis King
Executive Vice President, Founder
Applied Voice Technology

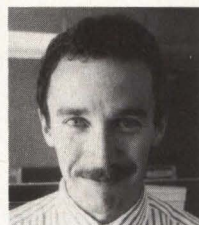

"The file manager is great. It's a step above the old DOS system. You don't have to remember commands and you don't have to read the manual."
John Martinson
Engineer
Pacific Gas Transmission



"Concurrent PC DOS gives us the capability to attach additional terminals for a more productive office. It has a true multi-user capacity. We can now meet deadlines."
Richard Vananda
Principal
Patrick Sullivan Associates, Architects



"I couldn't live without the product. Time is money and the ability to switch consoles and run more than one program has been a great time saver."
Joe Capp
Project Engineer
Union Carbide



"We have created a menu driven system that is totally transparent to our customers. By utilizing the menu system and 4 consoles concurrently we are able to fully utilize Concurrent PC DOS."
Subbash Chadba
MIS Director
Secoin Inc.

Make It Work For You!

Call (800) 443-4200 for the dealer or sales representative nearest you.

Concurrent PC DOS is a trademark and Digital Research is a registered trademark of Digital Research Inc. PhoneXpress is a trademark of Applied Voice Technology.



CIRCLE NO. 35 ON INQUIRY CARD

**THERE'S ONLY ONE THING
YOU NEED TO KNOW ABOUT
BUYING POS COMPONENTS.**

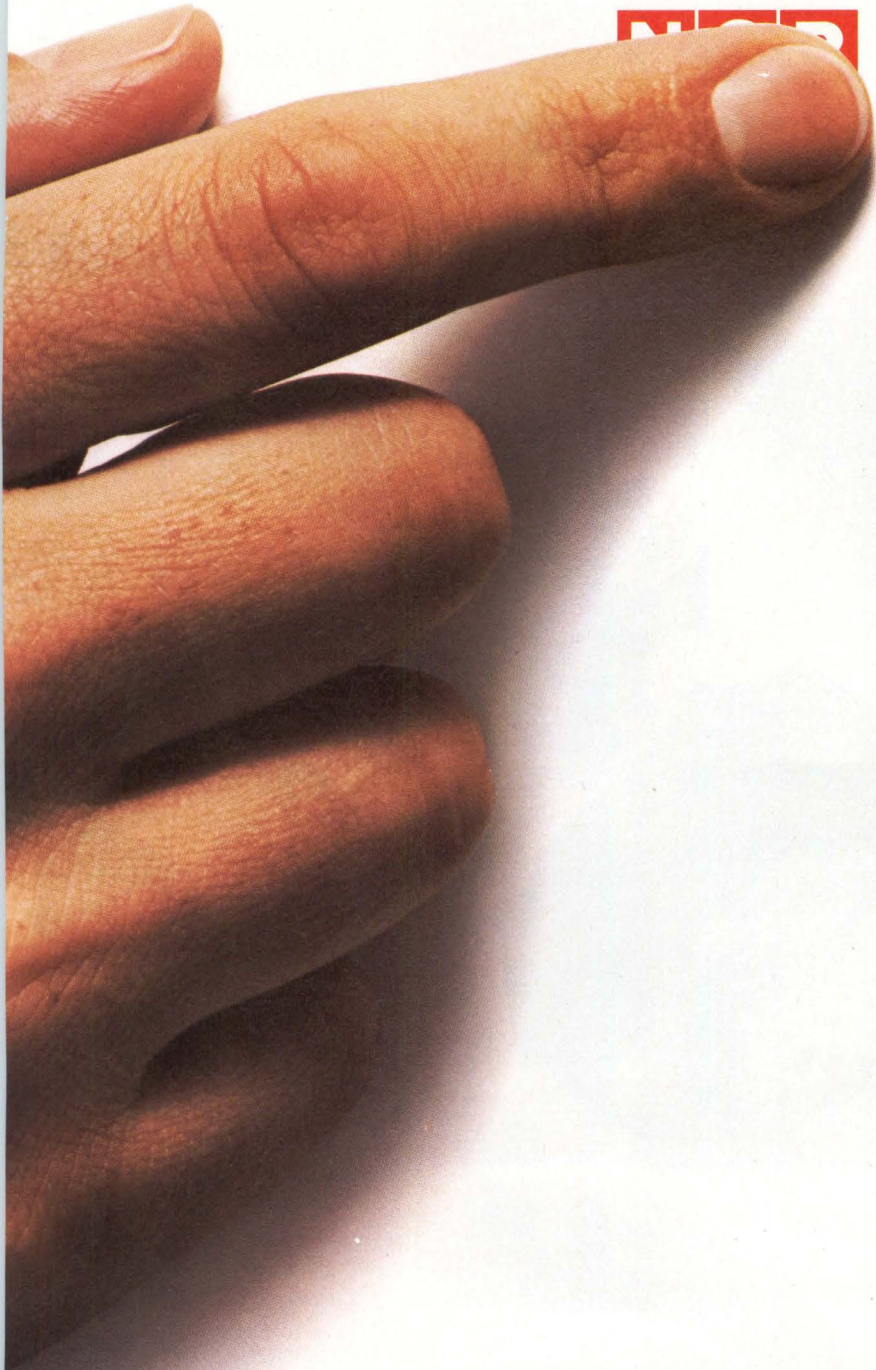

THESE DAYS, BUYING POS COMPONENTS
YOU NEED TO KNOW ABOUT



The Brand Name.

2192 Receipt Printer

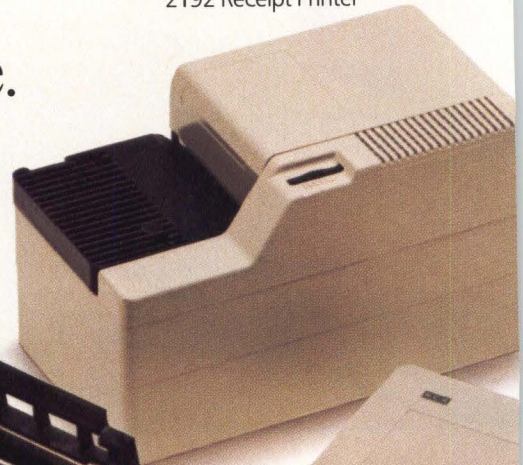

2285 Printer Mechanism

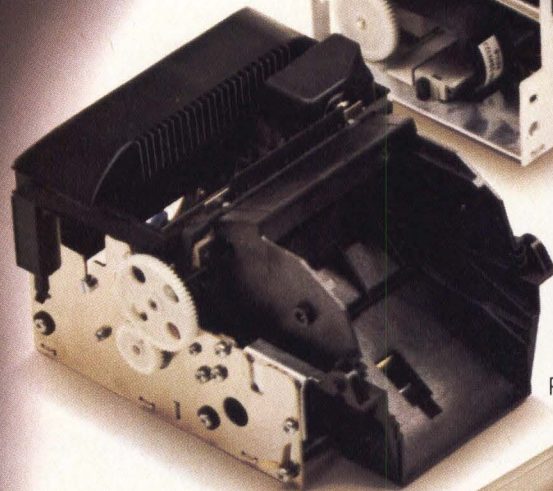
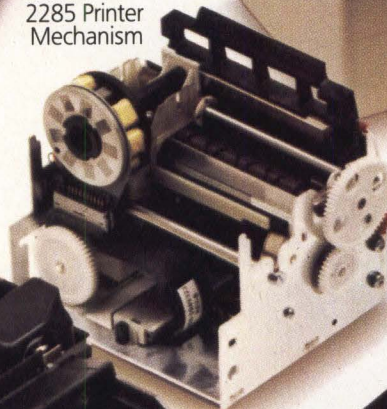

Paper Supply/Take-Up

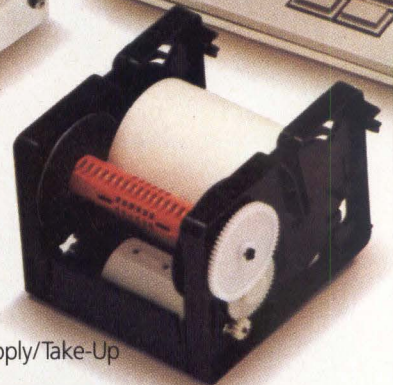

2282 Receipt Printer Mechanism



7830 Hand-Held Scanner

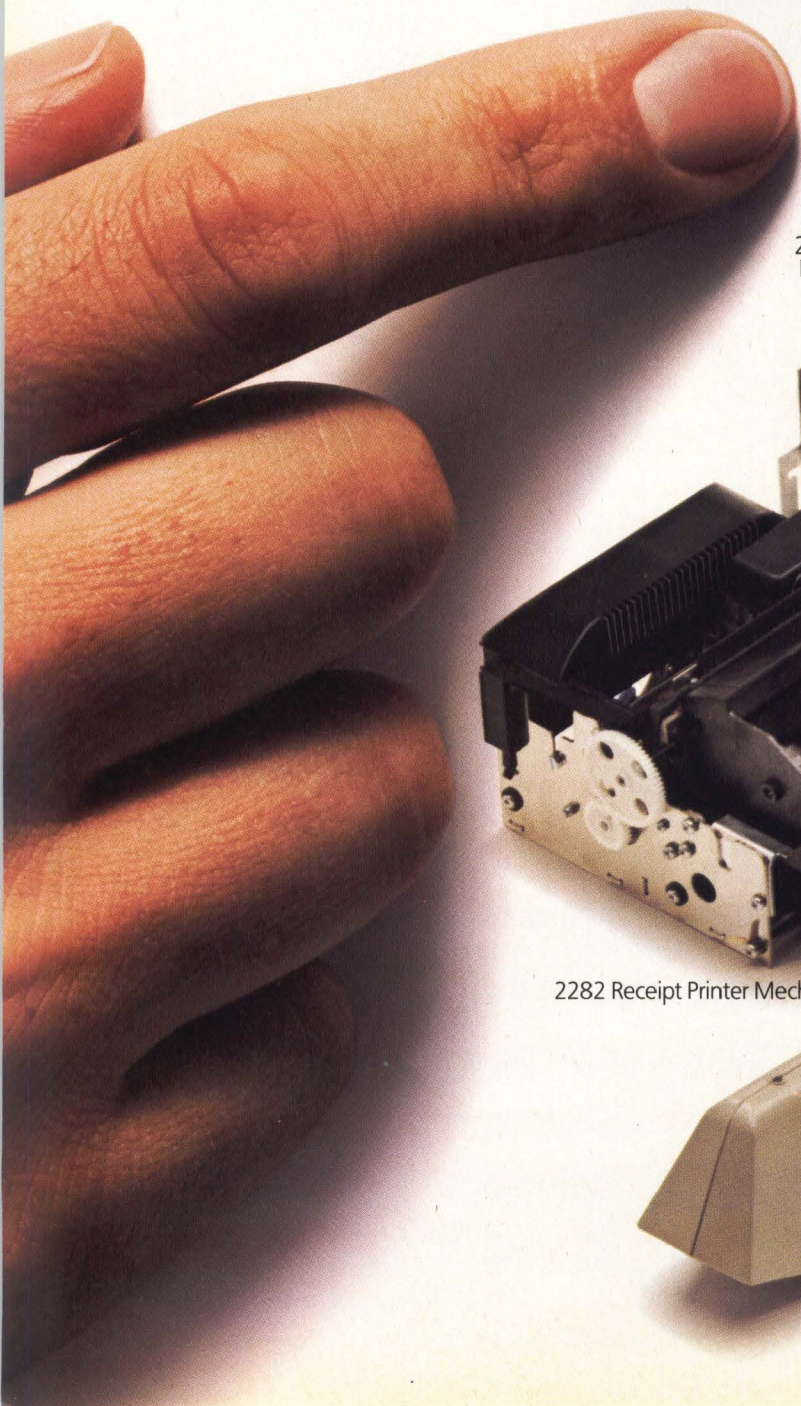

7060 Point-Of-Service Terminal

2567 Freestanding Slip Printer

2199 Printer Mechanism

4430 Mag Stripe Reader/Pin Pad



When you choose NCR printers, magnetic stripe readers, scanners, and other components for your point-of-service systems, you know you're getting the best. NCR uses identical components in our own systems. And no one has satisfied customers from retail stores to financial institutions longer or better than we have. In fact, with NCR's reputation, just using our components can help sell your systems. Not to mention making them run more dependably for years. The fact is, our products have been proved in thousands (and in some cases, millions) of retail and banking installations around the world.

Now there's only one more thing you need to know. Our phone number. Call 513-445-7443 to reach our Technology Marketing Division.

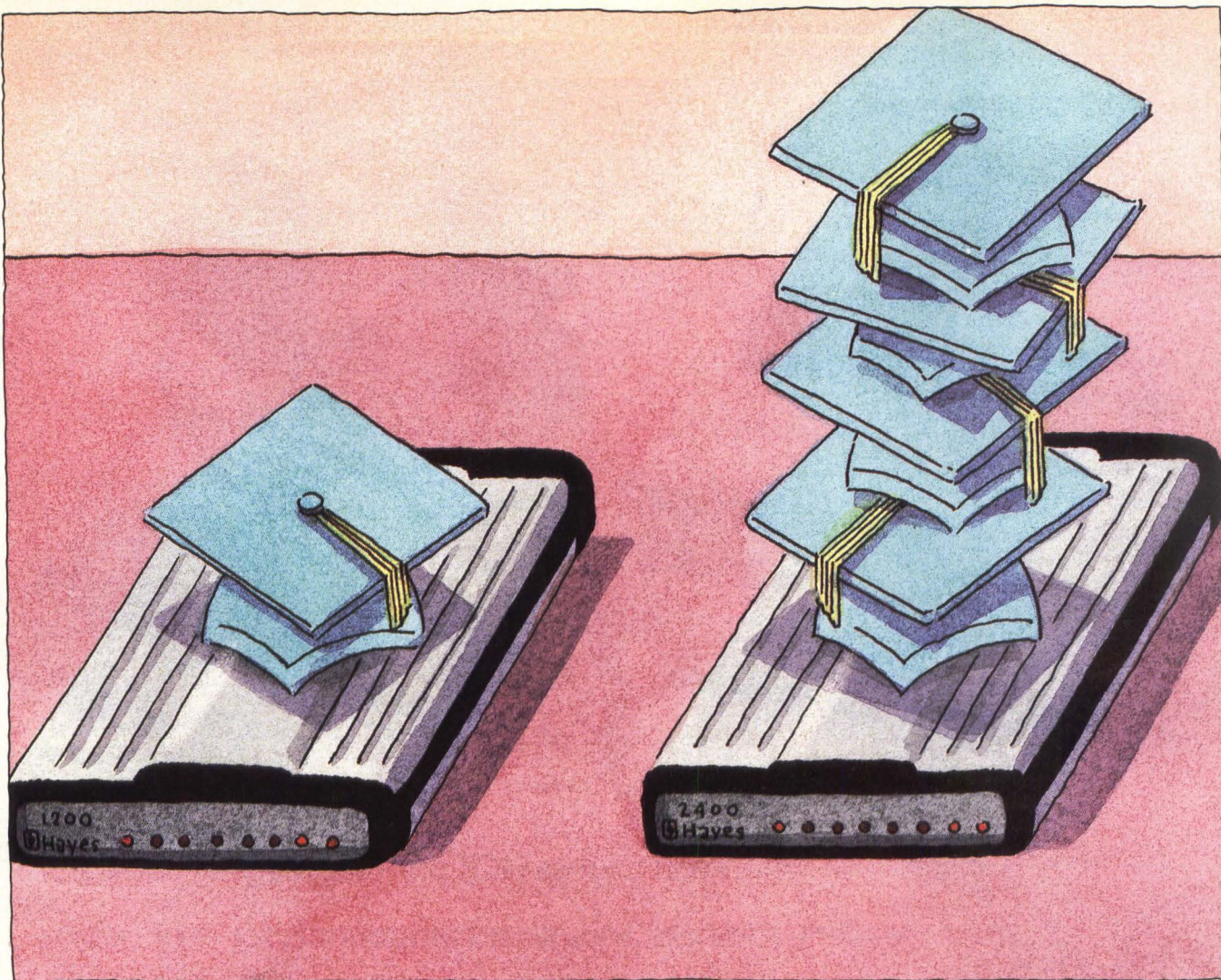

If the Hayes® Smartmodem 1200™ is smart, this one is utterly brilliant.

First came the Smartmodem 1200. Now, there's the smarter Smartmodem 2400.™ It's twice as fast. Or just as fast. Or even not as fast. Because it's smart enough to automatically adjust to 2400, 1200 or 300 bps communications. And to make sure you can communicate, it gives tests. It tests the phone line, it tests remote modems, it even tests itself. Because the Smartmodem 2400 features advanced diagnostics.

Moreover, the 2400 is a smart



communicator. It communicates with mainframes and minis. Both synchronous and asynchronous transmissions are supported by the Hayes standard command set for 2400 bps. And you can transmit data to another room, or another country because the 2400 meets CCITT international standards.

So, if you want to make fast work of high-volume communications, you'd be very smart to see your authorized Hayes dealer for a look at the Smartmodem 2400.

Now you can be smart, smarter and smartest all at once.

SMARTMODEM 2400

- Direct connect • Auto-answer/auto-dial
- Bell 103, 212A and CCITT V.22 and V.22 bis compatible • Synchronous or Asynchronous • Full or half duplex • Nonvolatile memory for communications settings
- Automatic fallback to 1200 or 300 bps
- Voice/data switching • Audio speaker
- Advanced diagnostic tests: analog, digital and remote digital loopback • Touch tone or pulse • Automatic adaptive phone line equalization • Two-wire lease line capability • Supports single and multi-line phone systems • Call progress monitoring

SMARTCOM II®

- Sold separately • Menu-driven communications software • 26 communications sets for automatic log-ons • Error-free XMODEM and Hayes Verification protocols • VT100/102 and VT52 emulation • Unattended batch operation • For most popular computers

© 1985 Hayes Microcomputer Products, Inc.

Hayes®

Say yes to the future with Hayes.
CIRCLE NO. 37 ON INQUIRY CARD

ELECTRONIC PUBLISHING LANDS ON THE DESKTOP

By combining microcomputers, page scanners and laser printers with specialized software, electronic publishing challenges traditional printing methods

Jerry Borrell

Senior Western Editor

Microcomputer-based electronic publishing (EP) systems produce output that rivals traditional printing technologies in quality. Costing less than \$10,000, low-end systems—integrating a microcomputer, a page scanner, a laser printer and EP software—enable users to combine text, line art and graphics without resorting to a corporate art department or photo-offset printing. High-end systems—in the \$100,000 range—integrate high-quality photographic reproduction and typesetter-ready output.

The potential market for EP systems is vast—a significant slice of the 7 percent to 10 percent of corporate revenues devoted to publishing activities, contends Bruce Blumberg, manager of printers and networking at Apple Computer Inc. Whatever the future, today's EP market is already on a fast growth track. Ajit Kapoor, director of EP at Dataquest Inc., San Jose, Calif., foresees 35 percent annual growth for the market through 1988. He estimates total sales rising from \$233 million in 1984 to \$1 billion in 1988.

Jay Prakash, vice president for computer aided design/computer aided manufacturing at Strategic Inc., Cupertino, Calif., predicts 37 percent total annual market growth through 1989. Prakash breaks the market into three segments and sees the highest annual growth rate, 51 percent, for a CAD technical-illustration segment. Sales of mid-range EP systems, such as Interleaf Inc.'s OPS-2000 (MMS, November 1984, Page 137) will exhibit 24 percent annual growth, with low-end, business-application systems showing 12 percent annual growth.

The market success of EP systems hinges on developments in four areas: hardware and soft-



A desktop EP system from Corporate Data Sciences integrates Talus' 200-dpi facsimile-based page scanner with image-processing software.

ware for text and graphics input, interface software, packages that manipulate text and graphics, and laser printers capable of both alphanumeric and graphics output. EP hardware and software can be further categorized as serving desktop/personal-publishing systems or in-plant systems. Defined by user needs, the systems differ in amount and quality of output, graphics-handling capabilities and type of documents they handle (including technical documents, proposals and memos.)

An EP system must accept data files from word processors or terminals; hard copy comprising text, line art and graphics; and documents created on other EP systems. EP users

“want to integrate multiauthor, multisystem documents to the input stream of publication,” explains Bob Baynor, vice president of Xerox Corp.’s Electronic Publishing Group.

But this input variety presents barriers to system integrators. For example, no EP system provides access to all types of data files. Compu-graphic Corp.’s new file translator is the exception to this rule, contends James Klauber, senior product manager for EP systems, in that it does provide universal file acceptance. Other EP system vendors develop interfaces as required by customers.

The problem of incompatible file formats has prompted the promulgation of standards proposals. Proposed by the Graphics Communications Association, standard generic mark-up language (SGML) provides generic codes by which typesetters automatically recognize the content and format of files. Document-format standards, such as IBM Corp.’s Document Content Archi-

ture (DCA) or the Navy’s Document Interchange Format (DIF), similarly provide codes that identify the content and format of electronic documents. The standards permit communications between different types of word-processing equipment.

Digitizing takes two approaches

EP users working with text, line art and graphics require digitizing hardware. EP systems take two approaches to this problem: optical character recognition (OCR) devices for text entry and optical scanners for graphics. Both benefit from low-cost charge coupled devices (CCD)—semiconductor sensors that have displaced higher cost tube-based image-capture systems.

CCDs are implemented as linear arrays in drum or flatbed scanners. Scanner vendors Datacopy Inc. and Ricoh Corp. use a flatbed approach, requiring the optics subsystem to move over the copy, as in commercial photocopiers.

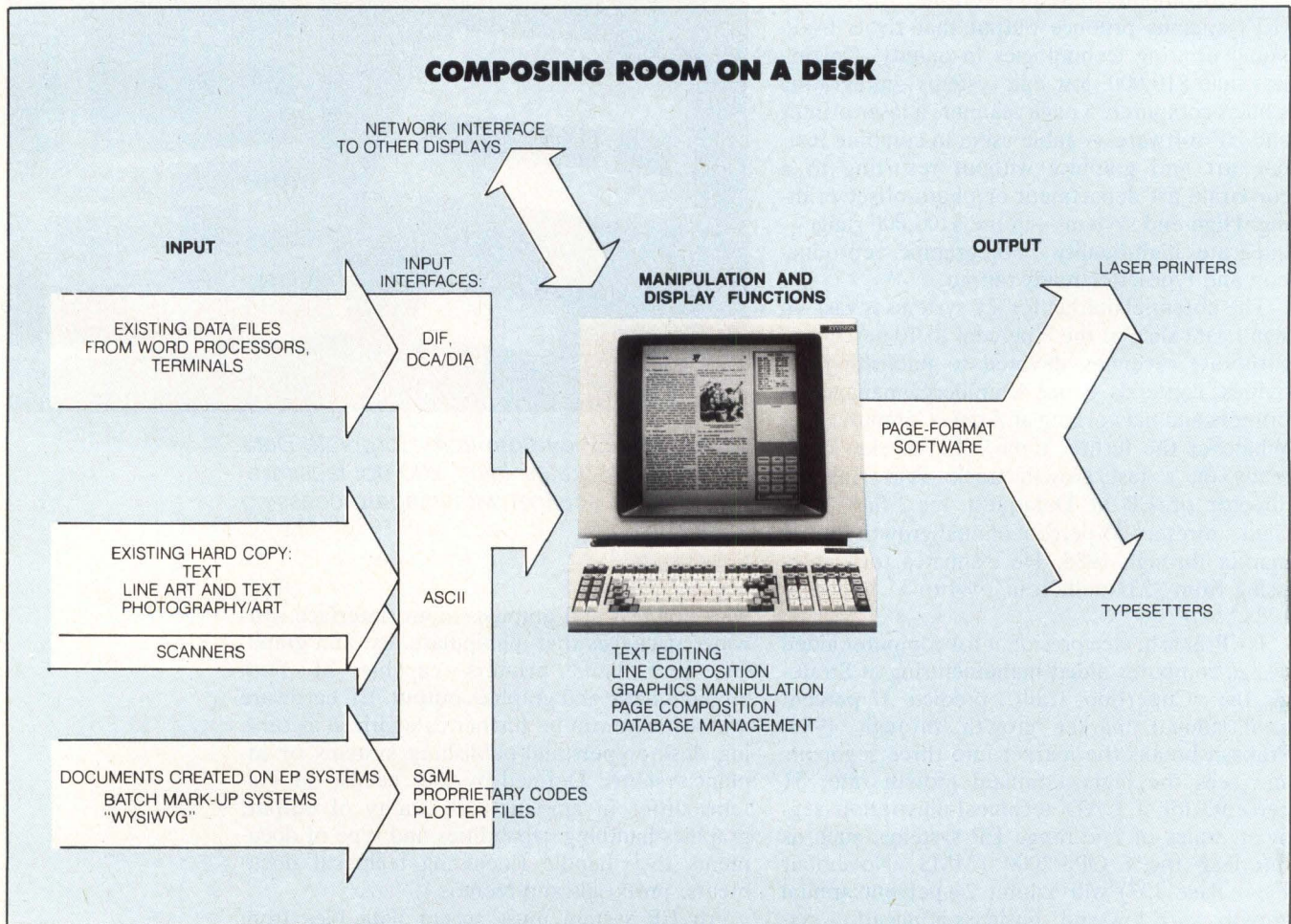

EP systems accept input from existing data files; hardcopy, including text and art; and documents created on other EP sys-

tems. They perform data-manipulation and display functions and send formatted pages to a laser printer or typesetter.

GOOD LOOKS RUN IN THE FAMILY.

LEXIDATA'S LEX 90 FAMILY OF HIGH PERFORMANCE DISPLAY PROCESSORS. LOOKING GOOD. LEX 90™ is Lexidata's newest family of raster graphics display processors. Its performance excites designers.

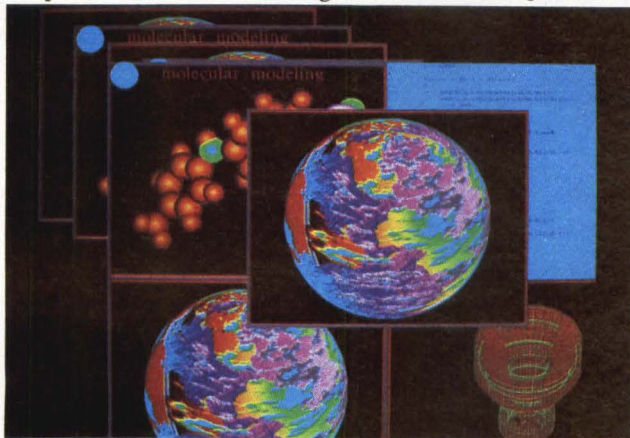

LEX 90's exclusive Virtual Windows functionality allows real-time color window management of up to eight user-defined windows.

And its cost-effectiveness excites executives. Which makes it look very good indeed. For example:

Every model in the LEX 90 family has the same basic components which use the latest bit-slice technology for rapid execution of complex graphics calculations.

And the family's flexible and compatible hardware/software

architectures have been designed to accommodate growth. So you'll never have to sacrifice your initial investment should you decide to enhance your LEX 90 system's perform-

ance. And what performance!

Our exclusive Virtual Windows, with real-time, color window management capability, allows you to define, manipulate and display eight viewports simultaneously. A True

Color configuration offers two buffers of 640x512x24 with an 8-bit color lookup table for each color.

Exclusive SimulRes functionality allows simultaneous display of 640x512 and 1280x1024 images on the same screen. And where you need high performance with high resolution,

there's a LEX 90 model that can support up to eight planes of 1280x1024 display memory at 60Hz non-interlaced refresh.

Intelligent List Language functionality enables enhanced local display list management. The extraordinary solid modeling display capability of our patented SOLIDVIEW® technology is available. And for oil applications, there's GEOVIEW™ a three-dimensional surface modeling package for geological interpretation.

On-board, micro-processor-controlled diagnostics help maximize uptime. And

the unique tilt-and-swivel movement of our monitor allows smooth and easy operation of your display.

Of course, the entire family is compatible with a variety of leading appli-

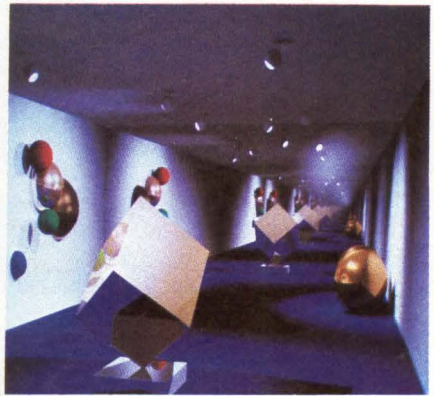

This gallery "exhibits" LEX 90's true color capability and appears courtesy of Cornell University's Program of Computer Graphics.

cation software packages and mini-computers. Which makes everyone look even better.

For a good look at the LEX 90 family and its expanding capabilities, call us at 1-800-472-4747. In Massachusetts, call 617-663-8550. Or write Lexidata Corporation, 755 Middlesex Turnpike, Billerica, Massachusetts USA 01865. TWX: 710-347-1574.

In UNITED KINGDOM call: Lexidata Ltd., Hook (025672) 3411. In FRANCE call: Lexidata SARL, Rungis (1) 4686-56-71.

In JAPAN call: Lexidata Technical Center, Tokyo 486-0670.

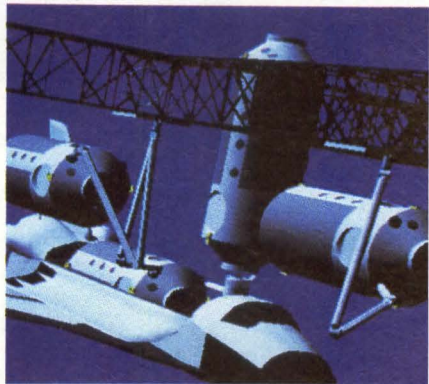

This space station model, courtesy of Martin Marietta, was created with Lexidata's SOLIDVIEW display technology, and GEOMOD™ application software from SDRC.



LEXIDATA®
LOOKING GOOD.

One great idea deserves another.

“My idea was to give our PC users of System 3X a unique file transfer option: freedom of choice.”

Our IDEAcomm 5251 works with PC Support/36 and a host of other file transfer packages.

No one gives IBM PC users more ways to transfer information to and from the IBM System 34/36/38 than IDEAssociates. For example, our IDEAcomm 5251 provides complete support for IBM's FSU and FTF programs. And we've just added PC Support/36 compatibility.

It's one more way we're keeping pace with IBM, step for step.

And as IBM announces enhancements, our in-house development capabilities will enable us to respond. Just as we were able to ship the first fully functional twinax emulator in 1984.

It shouldn't surprise you, then, to learn that many software companies have decided that our IDEAcomm 5251 is

the one they'll support. With file transfer packages like DecisionLink™, SmartLink™ and Intelink™, IDEAcomm gives PC users a broader range of options. Best of all, it does all this and still only requires 30K of memory.

So when you have a great idea for giving your PC users the freedom to choose file transfer options, look to IDEA.

Call us at 800-257-5027 for more information.

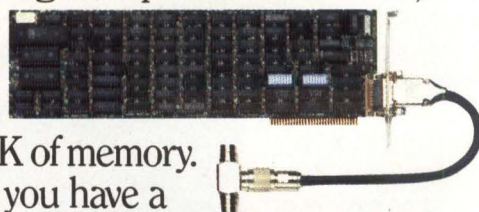
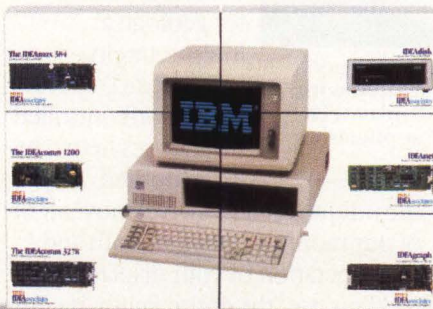

IDEA
IDEAassociates™
The best IDEAs for personal computers.
IDEAssociates, Inc., 35 Dunham Rd., Billerica, MA 01821,
(617) 663-6878, Telex 4979780. IDEAssociates, S.A., Paris,
Geneva, Switzerland (22) 86.11.19, Telex 428 388 KBSCH

IBM and the IBM logo are registered trademarks of International Business Machines Corporation. DecisionLink is a trademark of Laguna Laboratories Inc. Smart Link is a trademark of Software International. Intelink is a trademark of Marcam Data Systems Corporation, Inc. IDEAcomm 5251 is a trademark of IDEAssociates, Inc.

CIRCLE NO. 39 ON INQUIRY CARD

Talus Corp. and Dest Corp., however, borrow the drum approach from facsimile equipment, moving documents over the CCDs. Another scanner vendor, Thunderware Inc., produces a \$240 machine based on Apple's Imagewriter printer that captures text and graphics for the Macintosh.

OCR devices scan documents line-by-line using pattern-matching algorithms to identify the scanned characters. The fact that most office documents use a few "standard" fonts, such as Times Roman, Courier and Elite, lessens computational requirements. In reality, however, the same fonts are implemented differently by different manufacturers, making recognition a problem. As a result, OCR applications have been limited.

Optical scanning of graphics also presents problems. Digitizing line art is more practical than handling halftone or continuous-tone photography. But if users want to do more than "edit" pixels, then the system must recognize geometric shapes—points, lines, arcs—within the bit map. This recognition requires a raster-to-vector conversion, extremely troublesome to integrators, even in CAD systems. AutoDesk Inc.'s CAD/Camera and Optigraphics Corp. E-size-document scanner provide this capability for inputting drawings to CAD systems—at opposite ends of the cost/performance spectrum.

High-resolution photographic capture requires enormous amounts of memory and thus is impractical for all but high-end EP systems. Gary Mayerick, vice president of engineering at scanner vendor Imagitex Inc., points out that an 8-inch-by-11-inch page scanned at 300 dots per inch (dpi) requires 1M byte of storage. Increasing gray scale to 256 (8 bits per pixel) for an 8-inch-by-11-inch image requires 8M bytes. Bruce Mann, product planning manager at scanner supplier Information International Inc., asserts that photographs must be scanned at 1,200 dpi to meet prevailing publishing standards.

Desktop EP market burgeons

The market for single-user desktop EP systems, manipulating text, page layout and art, and producing less than 5,000 pages a year, has blossomed in 1985. The market has been driven by low-cost, powerful, easy-to-use packages running on Apple's Macintosh computer, such as Aldus Corp.'s Pagemaker and Manhattan Graphics Corp.'s ReadySetGo. Systems based on the IBM PC include DataCopy's Word Image Processing System and Corporate Data Sciences Inc.'s Data Center.

Interleaf, Xerox, Caddex Corp., Intran Corp., Prescience Inc., Textex Corp. and Xyvision Inc.

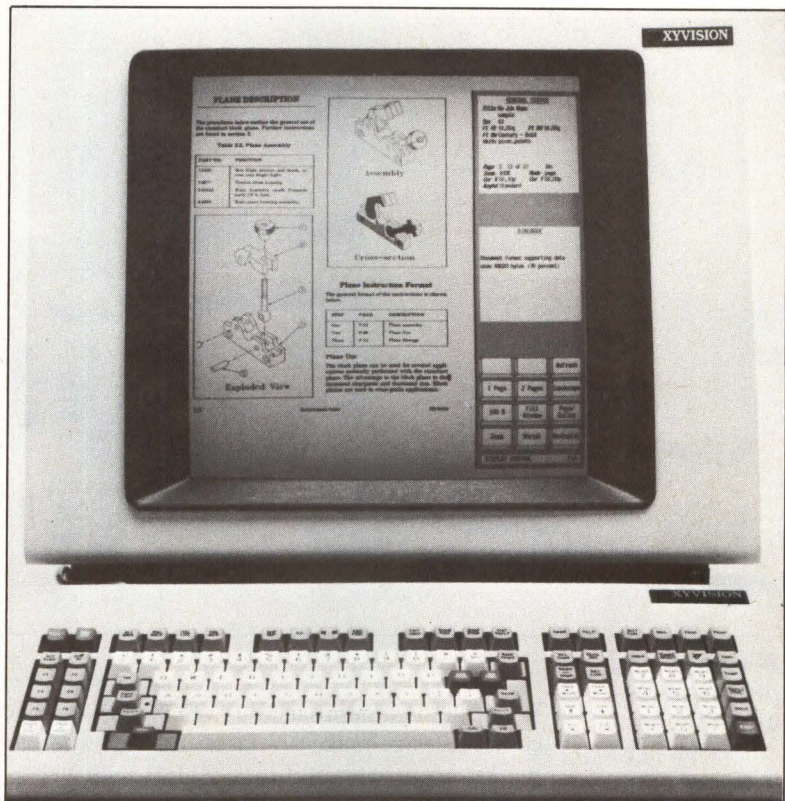

Interactively integrating art, text and tables is the job of the Xyvision EP system.

address in-plant production demands, focusing on systems that allow several writers and artists to work on a single document. Xyvision president Larry Liebson defines this EP configuration as one capable of producing 5,000 to 10,000 pages per year. Prescience bases its Hieroglyph package on Sun Microsystems Inc. workstations. The package runs as a concurrent application under UNIX and offers interactive data exchange between EP and other programs.

Vendors offering EP systems for technical illustration include Auto-trol Corp., Computer-vision Corp., Information International Inc., InterCAD Corp., Intergraph Corp., Qubix Graphics Systems Inc. and Versatec Inc.

Interactive input vs. mark-up languages

Creating pages on EP systems follows two different approaches—mark-up languages or interactive "What You See Is What You Get" (WYSIWYG) systems. Mark-up languages such as TEX, TROFF and SCRIBE require an imbedded command syntax, similar to that used by typesetters, to format a page of text. And, like typesetters, they have little graphics capability. Xerox's Baynor characterizes the difference be-



A charge-coupled device-based scanner captures line art, text and photographs for Data-copy's Word Image Processing System.

tween the two approaches: "WYSIWYG serves complex page-make-up tasks better, whereas mark-up languages suit massive text jobs such as phone directories, where pages are similar."

Mark-up-language-based systems target scientific and technical applications. Talaris Systems Inc. integrates laser printers from QMS Inc. with software to allow graphics produced by ISSCO's DISSPLA, Megatek Corp.'s Template or Tektronix Inc.'s 4010/14 to merge with text. Mark Skiba, vice president of the American Programmers Guild Ltd. (APG), developed INSET to serve engineering users of word-processing software. INSET runs as a concurrent application tool, allowing PC-based graphics generated by packages such as BrightBill Roberts and Co. Ltd.'s Graphix Partner to be merged with documents and transmitted to a graphics printer.

WYSIWYG systems are characterized by interactive manipulation of text and graphics for page make-up on a CRT. Despite these systems' promise, however, most have limited text, graphics and text/graphics-merging capability.

Displays quality documents

EP systems' manipulation of text and graphics requires high-quality displays. Displaying black text on a white background is an accepted standard—especially in light of the high cost and technical limitations of higher resolution color displays. Display quality reflects several factors: user preference, system cost and display format. The norm is 19-inch monitors that display a full 8-inch-by-11-inch page at actual size, useful in WYSIWYG applications.

Conversion of analog type to a bit map presents special demands, "a mixture of technology and visual perception," comments Mike Parker, president of Bitstream Inc. Representing type accurately requires large character matrixes and huge memories. "Matrixes 20 to 30 pixels on a side are needed to form the more elaborate fonts," notes David Boucher, president of Interleaf. This size matrix also lends itself to more efficient rasterization, he adds.

Most EP systems store the bit map and "tune" each font to their unique display resolution, i.e., the Macintosh's 72 dpi, the Sun workstations' 81 dpi and the Xyvision system's 100 dpi. Most ASCII terminals, by comparison, display only 20

Adobe Systems Inc.

Suite 100
870 Embarcadero
Palo Alto, Calif. 94303
(415) 852-0271
Circle 397

Aldus Corp.

Suite 400
616 1st Ave.
Seattle, Wash. 98104
(206) 467-8165
Circle 398

Allied/Linotype Co.

425 Oser Ave.
Hauppauge, N.Y. 11788
(516) 434-2016
Circle 399

Apple Computer Inc.

20525 Mariani Ave.
Cupertino, Calif. 95014
(408) 973-4409
Circle 400

Atex Inc.

32 Wiggins Ave.
Bedford, Mass. 01730
(617) 275-8300
Circle 401

Autodesk Inc.

2320 Marlinslip Way
Sausalito, Calif. 94965
(415) 332-2344
Circle 402

Auto-Trol

Technology Corp.
12500 N. Washington St.
P.O. Box 33815
Denver, Colo. 80233
(303) 452-4919
Circle 403

Bitstream Inc.

215 First St.
Cambridge, Mass. 02142
(617) 497-6222
Circle 404

Brightbill-Roberts and Co. Ltd.

Suite 421
120 E. Washington St.
Syracuse, N.Y. 13202
(315) 474-3400
Circle 405

Caddex Corp.

18532 142nd Ave. N.E.
Woodinville, Wash.
98072
(206) 481-7751
Circle 406

Compugraphic Corp.

80 Industrial Way
Wilmington, Mass. 01887
(617) 658-5600
Circle 407

Computervision Corp.

201 Burlington Road
Bedford, Mass. 01730
(617) 275-1800
Circle 408

Concept Technologies Inc.

P.O. Box 5277
Portland, Ore. 97208
(506) 684-3314
Circle 409

Corporate Data Sciences Inc.

2560 Mission College Blvd.
Santa Clara, Calif. 95054
(408) 980-9747
Circle 410

to 30 dpi. The Macintosh sacrifices some type quality in whole-page displays, but Apple's goal, insists John Scull, desktop publishing market manager at Apple, is to provide the "most functionality at the lowest cost." Ken Andrews, vice president of software engineering at Textet believes quality type representation requires 120 or 150 dpi. Other observers see this level of resolution as overkill, because CRTs will never match the quality of hard copy.

Whether to store fonts in individual bit maps or to store one description for each font, which is then sized and manipulated, is an issue that divides suppliers. John Warnock, president of Adobe Systems Inc., explains that problems with

bit maps, other than storage size, are not apparent at 1,000 dpi, but become obvious at lower resolutions when the typeface becomes distorted.

RIP units process images

Raster image processors (RIP), developed by laser-printer manufacturers, control print engines via a page-description language. The RIP processes a page description stored in its memory, as sent from the host computer.

The issues faced by RIP developers are numerous. For one, a RIP must have memory to store a bit map for a page of text and graphics. Some RIPs (from Hewlett-Packard Co. and

Companies mentioned in this article

Data Recording Systems Inc.
80 Rutland Road
Melville, N.Y. 11747
(516) 293-2400
Circle 411

Datacopy Corp.
1215 Terra Bella Ave.
Mountain View, Calif.
94043
(415) 965-7900
Circle 412

Dataproducts Corp.
6200 Canoga Ave.
Woodland Hills, Calif.
91365
(213) 887-8000
Circle 413

Dest Corp.
1201 Cadillac Court
Milpitas, Calif. 95035
(408) 946-7100
Circle 414

Eastman Kodak Co.
Business Systems
Markets Division
343 State St.
Rochester, N.Y. 14650
(716) 724-4000
Circle 415

Graphic Software Systems Inc.
Wilsonville, Ore. 97070
(503) 682-1606
Circle 416

Imagen Inc.
2650 San Tomas Expwy.
Santa Clara, Calif.
95052
(408) 986-9400
Circle 417

Imagitex Inc.
77 Northeastern Blvd.
Nashua, N.H. 03062
(603) 889-6600
Circle 418

Information International Inc.
5933 Slauson Ave.
Culver City, Calif.
90230
(213) 390-8611
Circle 419

Integrated Software Systems Corp.
10505 Sorrento
Valley Road
San Diego, Calif. 92121
(619) 452-0170
Circle 420

InterCAD Corp.
175 Admiral Dorchrove Drive
Annapolis, Md. 21401
(301) 224-2926
Circle 421

Intergraph Corp.
1 Madison Industrial Park
Huntsville, Ala. 35807
(205) 772-2000
Circle 422

Interleaf Inc.
1100 Massachusetts Ave.
Cambridge, Mass. 02138
(617) 497-5570
Circle 423

International Typeface Corp.
866 Second Ave.
New York, N.Y. 10017
(212) 371-0699
Circle 424

Intran Corp.
Image Management Group
1600 W. 82nd St.
Minneapolis, Minn. 55431
(612) 888-4415
Circle 425

Manhattan Graphics Corp.
163 Varick St.
New York, N.Y. 10013
(212) 924-2778
Circle 426

Megatek Corp.
9645 Scranton Road
San Diego, Calif. 92121
(619) 455-5590
Circle 427

Prescience Inc.
Suite 300
820 Bay Ave.
Capitola, Calif. 95010
(408) 462-6567
Circle 428

QMS Inc.
P.O. Box 81250
Mobile, Ala. 36689
(205) 633-4300
Circle 429

Qubix Graphics Systems Inc.
1255 Parkmoor Ave.
San Jose, Calif. 95126
(408) 292-4000
Circle 430

Ricoh Corp.
5 Dedrick Place
West Caldwell, N.J. 07006
(201) 882-2114
Circle 431

Sun Microsystems Inc.
2550 Garcia Ave.
Mountain View, Calif.
94043
(415) 960-7421
Circle 432

Talaris Systems Inc.
P.O. Box 261580
San Diego, Calif. 92126
(619) 587-0787
Circle 433

Talus Corp.
985 University Ave.
Los Gatos, Calif. 95030
(408) 354-5322
Circle 434

Tegra Inc.
900 Middlesex Turnpike
Billerica, Mass. 01821
(617) 663-7435
Circle 435

Tektronix Inc.
P.O. Box 1700
Station 43-314
Beaverton, Ore. 97075
(800) 547-1512
Circle 436

Textet Corp.
37 Broadway
Arlington, Mass. 02174
(617) 641-2900
Circle 437

Thunderware Inc.
21 Orinda Way
Orinda, Calif. 94563
(415) 254-6581
Circle 438

Versatec Inc.
2710 Walsh Ave.
Santa Clara, Calif.
95051
(408) 988-2800
Circle 439

Xerox Corp.
Electronic Publishing
Business Unit
9745 Business Park Ave.
San Diego, Calif. 92131
(619) 695-7729
Circle 440

Xyvision Inc.
52 Cummings Park
Woburn, Mass. 01801
(617) 938-8095
Circle 441

Most EP systems store the bit map and 'tune' each font to their unique display resolution.

Tegra Inc., for example) have less than a full page of memory. This method saves memory, but requires a complex RIP architecture to process the page "on the fly." For another thing, the reading of data from RAM and onto a moving printing drum presents design challenges involving high bandwidth and precise synchronization.

The technique chosen to draw type represents a third group of issues. HP stores fonts in hardware ROM cartridges, providing speed but limiting the number of fonts, styles and point sizes available. Postscript, from Adobe, stores a single model for all fonts, scaled or modified as needed—a flexible approach but requiring additional processing by the RIP. Imagen Inc.'s Impress language borrows from both approaches. The RIP scales fonts in ROM but, unlike Postscript, it drives only Imagen printers.

Lasers make it possible

Once created on an EP system, a document must be sent to a printer. Traditionally, a chronic incompatibility exists between typesetters and text-entry devices. Each typesetter has unique interface hardware and software. An entire sub-

industry sells black boxes or "shaftstall" equipment to convert data among terminals, typesetters and host computers from different manufacturers.

Similarly, vendors of laser printers develop unique languages to drive their devices. "Drivers are more complex because printers have changed from dumb peripherals to intelligent systems," declares Jerry Ervin, senior product manager at Dataproducts Corp. This means further problems for integrators who must interface EP systems to a variety of output devices.

Concept Technologies Inc. resolves this problem with Graphic Software Systems Inc.'s (GSS) virtual device interface (VDI), easing driver development. The need for system integrators to supply software interfaces is changing, due in part to the increasing complexity of printer controllers.

Laser printers rival expensive typesetters in terms of cost, speed and size. However, the great quandary for laser-printer integrators begins with their choice of RIP architecture and page format. Some vendors avoid the issue by supporting multiple printer-interfacing standards. QMS, for example, supports Postscript, Interpress and its proprietary standard QUIC.

As these issues are resolved, manufacturers must still address the question of printer resolution. Data Recording Systems Inc. already offers an 800-line-per-inch laser printer. Tom Fay, executive vice president at Tegra contends that its 1,000-dpi Genesis laser printer, driven by Canon U.S.A.'s LBP-5 print engine, competes with digital typesetters.

In 1986, 400- to 500-dpi laser printers, based on the Canon LX engine, will appear. Some of these products will remain in the price range of today's 300-dpi printers. Luis Trabb Prado, vice president and founder of Imagen, cautions that above 480 dpi, design issues beyond resolution, such as paper handling and registration, come into play. This will keep printer costs high. But typical EP system users will continue to demand—and get—higher resolution laser printers.

EP system integrators will face competition in 1986 from traditional printing-industry vendors such as Compugraphic, Allied/Linotype Co. and Eastman Kodak Co. For example, Kodak owns Atex Inc., Iconix Inc. and Verbatim Inc. and holds substantive investments in Interleaf and Sun Microsystems, positioning it as a dominant force in EP systems. □

TERMINALS FROM TRANSNET

PURCHASE PLAN - 12 & 24 MONTH FULL OWNERSHIP - 36 MONTH LEASE PLAN

DESCRIPTION	PURCHASE PRICE	PER MONTH		
		12 MOS	24 MOS	36 MOS
DEC				
LA50 Personal Printer.....	\$599	\$ 58	\$ 32	\$ 22
LA210 Letter Printer.....	1,299	125	70	47
LA120 DECwriter III KSR.....	2,195	211	117	79
VT220 Video Terminal.....	849	83	46	31
VT240 Graphics Terminal.....	1,850	178	99	67
VT241 Color Graphics Terminal.....	2,650	255	142	95
LN03 Laser Printer.....	3,295	316	176	119
TI				
TI707 Portable Data Terminal.....	\$ 550	\$ 53	\$ 30	\$ 20
TI820 Data Terminal PKG KSR.....	1,995	192	107	72
TI855 Dual Mode Printer.....	625	60	34	23
TI865 Dual Mode Microprinter.....	780	75	42	29
WYSE				
WY50 Video Terminal.....	\$ 459	\$ 44	\$ 25	\$ 17
WY75 Video Terminal.....	559	56	30	20
WY85 Video Terminal.....	559	56	30	20
PANASONIC				
FT70 Executive Partner PC.....	\$1,999	\$249	\$139	\$ 94
NRTHN TELECOM				
NT6K90 Displayphone Plus.....	\$995	\$ 97	\$ 54	\$ 37
CITOH & CIE				
CIT220+ Video Terminal.....	\$775	\$ 75	\$ 42	\$ 28
CI300 Matrix Line Printer.....	4,045	388	216	146
CI3500 Serial Printer.....	1,145	110	62	42

Call for special prices on: OKIDATA, EPSON, DATA GENERAL, ALTOS, NCR, APPLE and other popular equipment. PRICES GOOD TO DECEMBER 31, 1985 Full ownership after 12 or 24 months - 10% purchase option after 36 months



TransNet Corporation

1945 ROUTE 22 - UNION - N.J. 201-688-7800

1-800-526-4965 (Outside N.J.)

Offices in Philadelphia and New York City

CIRCLE NO. 41 ON INQUIRY CARD

Interest Quotient (Circle One)
High 489 Medium 490 Low 491

“Power Protection”

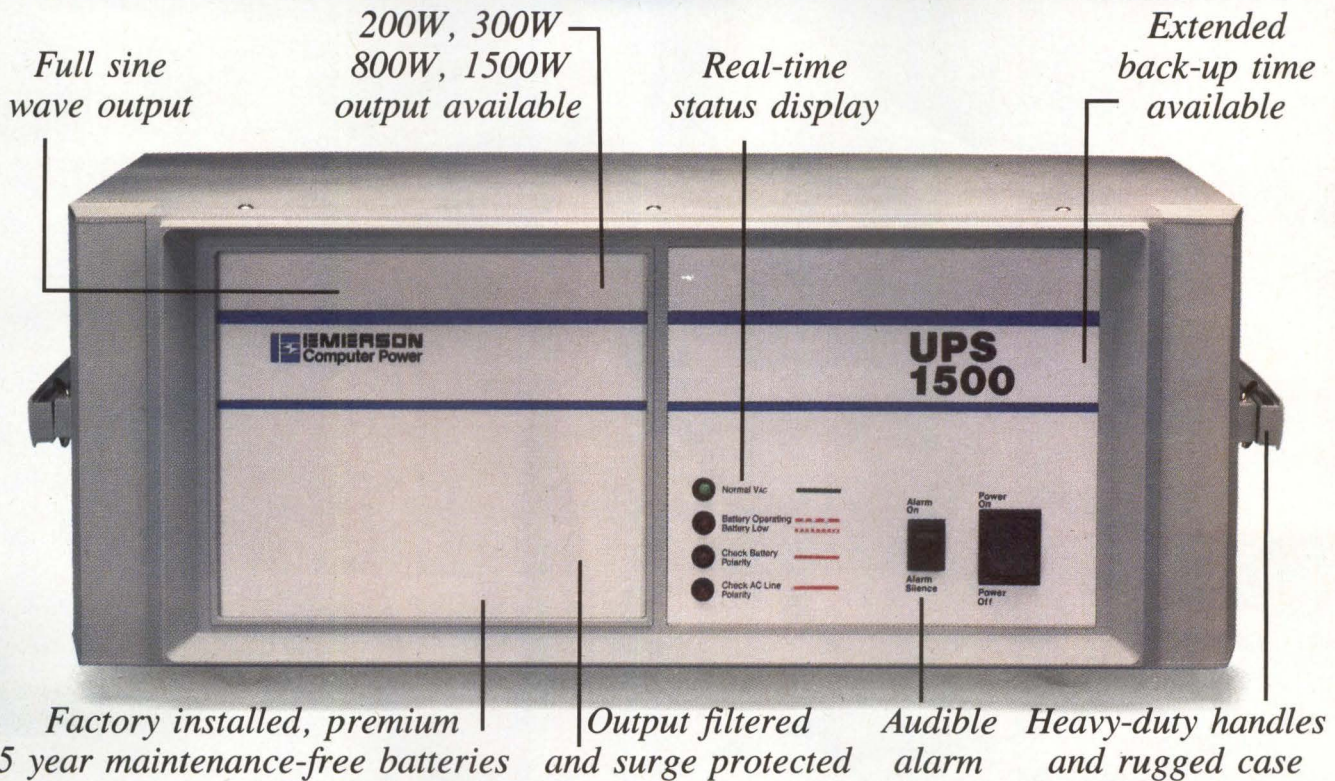

Announcing: AP1000 Series UPS Full sine wave UPS for low power applications from Emerson, the Technology and Price Leader in Uninterruptible Power Systems

Your electronic equipment depends upon clean uninterrupted power. If that power is disturbed by “Black-outs”, “Brown-outs”, Spikes or Surges, your equipment could be damaged and memory lost. Your valuable system becomes worthless.

Do you have these?

P.C.'s, office computers, ATM's, PBX's, Point of Sale Terminals, Security Systems, or Test Equipment. They could be vulnerable to power-line disturbances.

Now they can be economically protected with the new Emerson AP1000 Series UPS with power ratings from 200-1500 watts and starting at \$379. From 200VA to 4,000 KVA, Emerson has you covered.

For a free Technical Brochure and the Distributor/Dealer nearest you, call toll free 1-800-BACK-UPS. Emerson Computer Power, 3300 S. Standard St., Santa Ana, California 92702.

CALL
1-800-BACK-UPS
For Your Free
Technical
Brochure



EMERSON
Computer Power



Westinghouse brought in TI's Personal Consultant™ because these experts don't have time to waste.

Personal Consultant is the expert systems development software that's turning the time they spend answering routine questions into research and development.

Dr. Neil Pessall and Dr. Jan Schreurs, research scientists at the Westinghouse Research and Development Center, had a problem. How could they make hundreds of man-years worth of practical knowledge at the Center readily available to Westinghouse and its customers, without pulling the scientists away from their research to answer routine questions?

Their solution was Personal Consultant, a new expert systems development software tool from Texas Instruments for TI or IBM® personal computers.

Designed to run on 512K-Class Personal Computers, Personal Consultant

provided Westinghouse an eminently affordable new tool for the development of expert systems. Pessall and Schreurs were especially impressed with its ability to aid experts in developing the knowledge bases and prototyping programs which even first-time computer users could consult for expert advice.

"With Personal Consultant software," says Schreurs, "we found it far easier to teach our experts how to develop a system than teach a programmer to be an expert." In fact, the software's rapid expert system prototyping and simple debugging features enabled the two scientists to demonstrate three different expert systems in as many weeks. Schreurs produced one for training new salespeople and a second to guide repairs and maintenance for the Center's X-ray diffractometer.

Pessall's makes material recommendations for tubes and support plates in steam generators.

"Our development of expert systems isn't aimed at replacing experts," says Dr. Pessall. "Its purpose is to give them the time to extend their expertise while the expert systems handle consultations on well-established knowledge and methodology."

To put Personal Consultant from TI to work for your business, call (800) 527-3500, in Canada call (416) 884-9181. Because an expert's time is too valuable to waste.

**TEXAS
INSTRUMENTS**

Creating useful products
and services for you.

28231
© 1985 TI

Personal Consultant is a trademark of Texas Instruments Incorporated.
IBM is a registered trademark of International Business Machines Corporation.

CIRCLE NO. 42 ON INQUIRY CARD

THIN FILM CHALLENGES OXIDE MEDIA

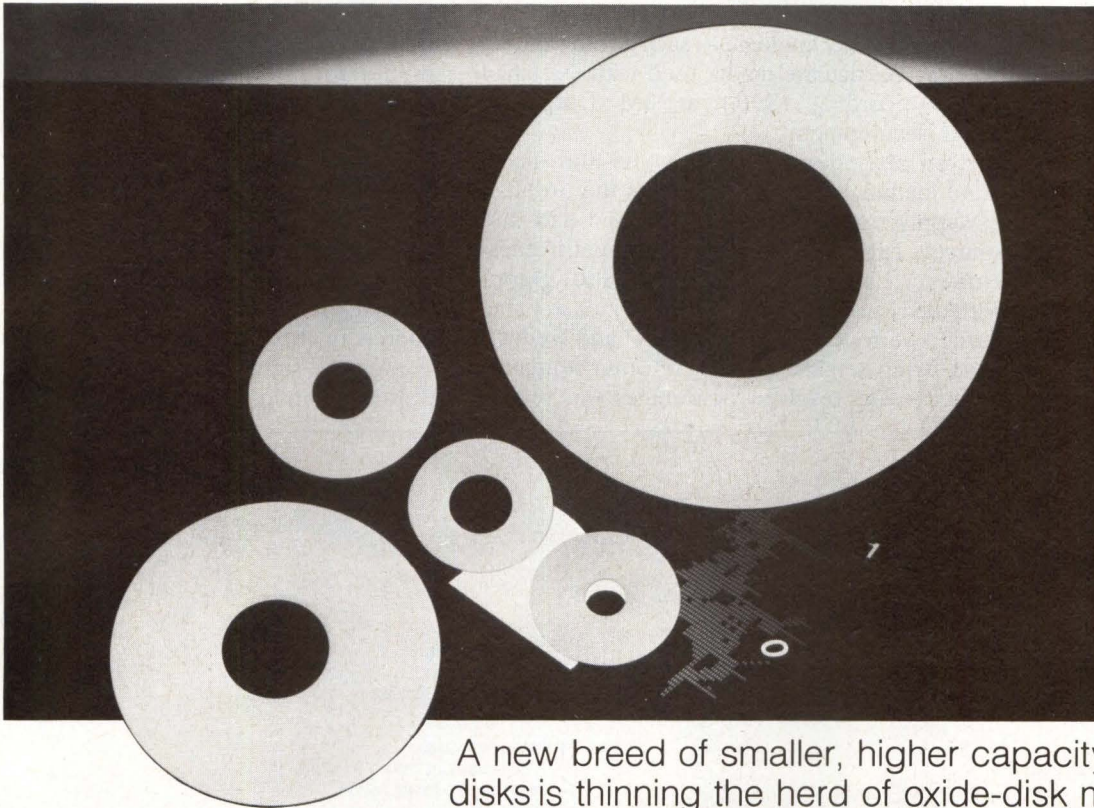

Photo: Courtesy of Ampex Corp.

A new breed of smaller, higher capacity rigid disks is thinning the herd of oxide-disk makers, but it's still not clear which species will reign

Dennis D. Waid, Peripheral Research Corp. and **Don Mann**, Don Mann Magnetics Inc.

Disk drive capacities increased approximately fivefold from 1973 to 1981 and are expected to double again by 1986 or 1987. This second growth spurt will result primarily from improved media performance. Although recording-head technology has changed over the years, magnetic media coating technology remained relatively stable from 1962 to 1981. The coating was typically 330-oersted (Oe), 35- μ in, gamma ferrous-oxide on an aluminum substrate.

Thin-film media—the “new” alternative—has actually existed for more than 20 years. But in the past it was produced only by a few companies, and its market appeal was limited because standard oxide media performed adequately. But since 1982—because of an influx of venture capital and increasing demands of disk drive manufacturers—about 15 companies have become involved in thin-film-media production. Disk media now divides into two basic categories: oxides (standard and high-coercivity) and

thin film (plated, sputtered and plated with sputtered overcoat).

Storage demands accelerate

Demand for small-diameter disks is expected to continue through the late 1980s because of the popularity of the microcomputer and the mandate for additional on-line storage. According to the *1984 Disk/Trend Report*, Mountain View, Calif., shipments of 5 $\frac{1}{4}$ - and 3 $\frac{1}{2}$ -inch disks will increase from about 7.7 million in 1984 to around 22.9 million in 1987.

Drive manufacturers continue to demand higher capacity, lower cost per megabyte, greater reliability and smaller size. Three rigid disk drives introduced in 1984 exemplify this trend: a 51.4M-byte, 3 $\frac{1}{2}$ -inch model from Newbury Data Recording Ltd., Staines, England; a 306M-byte, 5 $\frac{1}{4}$ -inch drive by the Memory Products Division of Siemens Communications Systems Inc., Westlake Village, Calif.; and a 760M-byte, 5 $\frac{1}{4}$ -inch drive from Maxtor Corp., Santa Clara, Calif.

Those higher capacity products require perfor-

mance not available with today's oxide-disk technology. Different forms of plated media are being used to fill the current need, and radically different disk technologies—such as the random-oriented particulate media used with stretched-surface-recording (SSR) at 3M Corp.—are under development.

Even after deciding to use thin-film media, drive manufacturers must address the problems of supply, production yields, second and third sources, ruggedness and price competitiveness. However, media manufacturers also grapple with the issues of second-sourcing, industry standards, performance consistency and reduced head-flying heights. How these often-conflicting concerns are resolved determines the relative

strengths and weaknesses of the media choice.

High bit density is a pre-eminent concern among users of disk media. Technical considerations include flying height, resolution requirements for modified frequency modulation (MFM) data encoding, coercivity, output and on- and off-track overwrite. Unfortunately, improving one specification sometimes involves a trade-off in another area.

The limitations of standard 330-Oe oxide relate to the magnetic coating's relatively low coercivity, which results in demagnetization losses that are proportionate to bit density. Low coercivity also causes poor resolution and inadequate head-signal output.

Resolution and head-signal output can be im-

REPRESENTATIVE RIGID DISK									
	Standard oxide	High-coercivity oxide	Plated	Sputtered		Standard oxide	High-coercivity oxide	Plated	Sputtered
Akashic Memories Corp. 3570 Ryder St. Santa Clara, Calif. 95051 Circle 335				•	Cyberdisk Inc. 1531 S. Sinclair St. Anaheim, Calif. 92806 Circle 345				•
Ampex Corp. Disk Media Operations 960 Rincon Circle San Jose, Calif. 95131 Circle 336			•		Datapoint Corp. 9725 Datapoint Drive San Antonio, Texas 78284 Circle 346			•	
Anelva Corp. 121 E. Brokaw Road San Jose, Calif. 95112 Circle 337				•	Domain Technology 304 Turquoise St. Milpitas, Calif. 95035 Circle 347			•	
Applied Information Memories 776 Sycamore Drive Milpitas, Calif. 95035 Circle 338				•	Dysan Corp. 5201 Patrick Henry Drive Santa Clara, Calif. 95050 Circle 348	•	•		
BASF Systems Corp. 35 Crosby Drive Bedford, Mass. 01730 Circle 339	•				Eikon Inc. 69 Moreland Road Simi Valley, Calif. 93065 Circle 349			•	
Brown Disk Manufacturing Inc. 1110 Chapel Hills Drive Colorado Springs, Colo. 80918 Circle 340	•	•			Fujitsu Ltd. 36 Kita-Owaribe Nagano, 380, Japan Circle 350				•
Burton Magnekote 11334 Playa St. Culver City, Calif. 90230 Circle 341				•	Genex Inc. 47050 Kato Road Sunnyvale, Calif. 94538 Circle 351				•
Charlton Associates Inc. 1 Marconi Irvine, Calif. 92718 Circle 342	•	•			Hewlett-Packard Co. P.O. Box 15 Boise, Idaho 83707 Circle 352				•
Control Data Corp. 8100 34th Ave. S. Minneapolis, Minn. 55440 Circle 343	•				Ibis Systems Inc. 1850 Evergreen Drive Duarte, Calif. 91010 Circle 353			•	

proved through high-energy and high-coercivity oxide coatings, but overwrite then becomes a problem, particularly when the head resides reliably at a 19- μ in flying height. The higher coercivity surface causes serious cross-read residuals from adjacent tracks, so even measuring overwrite while the head is on track is deceiving—off-track overwrite becomes critical. Another problem is that the cobalt used in higher coercivity coating contributes to peak shifts—a crossing of frequency curves—and distortion.

Overcoating: fact or fiction?

Overcoating—usually carbon or graphite—remains controversial. Some experts maintain that a sputtered overcoat provides ruggedness, pre-

vents corrosion and achieves low static friction. Others claim that overcoating furnishes only psychological comfort—that the corrosion problem was invented by oxide-disk manufacturers with large investments in oxide coatings.

The thinner coatings used with plated and sputtered media help correct the peak-shift and overwrite problems of thick high-coercivity oxides, but to fully utilize the advantages of thin coatings, the flying heights need to be reduced to 10 μ in. This means burnishing the media at 4 μ in, glide testing at 6 μ in and certifying the disk at 8 to 10 μ in. All of these requirements translate into increased disk cost and limited media availability. A few companies such as Komag Inc. routinely glide test at 5 microinches.

MEDIA MANUFACTURERS

	Standard oxide	High-coercivity oxide	Plated	Sputtered		Standard oxide	High-coercivity oxide	Plated	Sputtered
IBM Corp. 5600 Cottle Road San Jose, Calif. 95193 Circle 354	•				Microdisk (SyQuest Tech.) 47923 Warm Springs Blvd. Fremont, Calif. 94539 Circle 363			•	
Information Memories Corp. 2875 N. Western Pkwy. Santa Clara, Calif. 95051 Circle 355			•		Nashua Corp. 44 Franklin St. Nashua, N.H. 03061 Circle 364	•	•		
Kearney Magnetics Inc. 150 Charcot Ave. San Jose, Calif. 95131 Circle 356		•			Oktel Corp. (Xidex) 1220 Page Ave. Fremont, Calif. 94538 Circle 365				•
Komag Inc. 591 Yosemite Drive Milpitas, Calif. 95035 Circle 357				•	SAEmag International Inc. 350 Martin Ave. Santa Clara, Calif. 95050 Circle 366			•	
KSI Systems 14055 Larchwood Place Chino, Calif. 91710 Circle 358			•		3M Corp. Data Recording Div. 3M Center St. Paul, Minn. 55101 Circle 367	•	•		
Lanx Corp. 1750 Junction Ave. San Jose, Calif. 95112 Circle 359				•	TriMedia Corp. 47730 Westinghouse Drive Fremont, Calif. 94539 Circle 368				•
Lin Data Corp. 2005 De La Cruze Blvd. Santa Clara, Calif. 95050 Circle 360				•	Ultra-Disc Corp. (CCT) 690 Gibraltar Drive Milpitas, Calif. 95035 Circle 369			•	
Media Technology Corp. (STC) 575 Dado St. Mountain View, Calif. 95131 Circle 361			•		Zwan Magnetics 1607 16th St. Santa Monica, Calif. 90404 Circle 370				•
Megastor (Tandon) 5102 Calle Del Sol Santa Clara, Calif. 95054 Circle 362			•						

THIN FILM SURPASSES OXIDE MEDIA

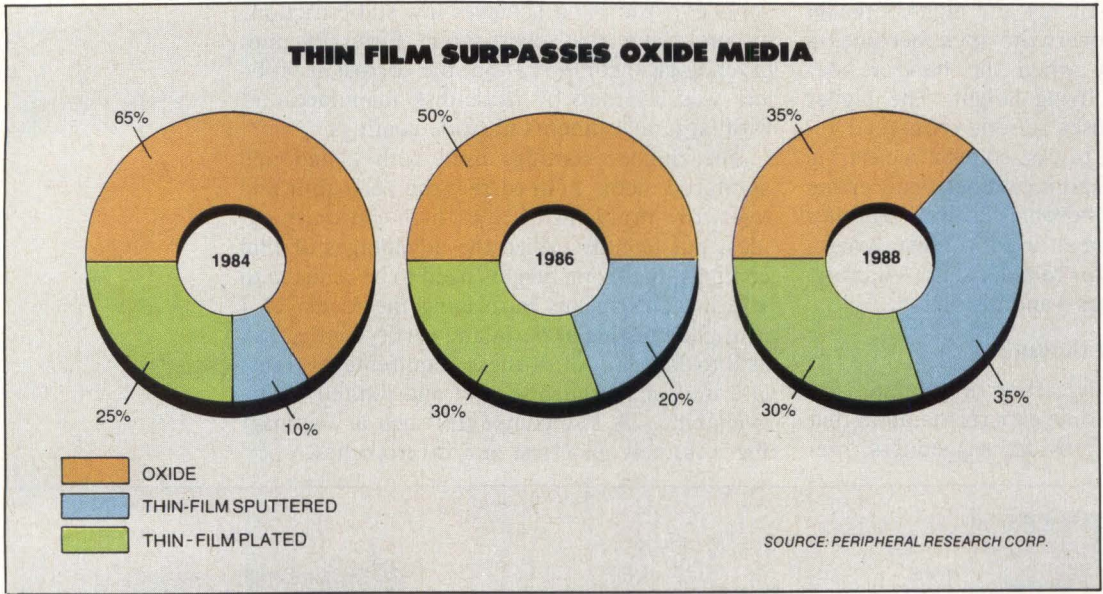

Sputtered and plated media will encroach significantly on the standard oxide market share.

It's generally thought that perpendicular recording on flexible disks will materialize within the next few years, primarily from Japanese manufacturers. Perpendicular recording on rigid disks—currently done by only a few manufacturers—will be a niche market. It will not be widely accepted due to media-durability problems and data rates that are too high for current system architectures. However, less expensive, more flexible controllers and acceptability of higher data rates could bring perpendicular recording to the forefront of media technology. To date, only Lanx Corp. has concentrated on this technology.

Reversible optical recording is on the horizon and will offer much lower cost per megabyte than thin-film or perpendicular recording. The cost per megabyte for reversible optical record-

ing is expected to be as low as \$1.50 for end users. (Today's Winchester technology costs \$12 to \$18 a megabyte.) But currently, optical disks offer write-only capability. Getting to reuse the disk in a read/write/erase application will require advances in magneto-optical recording techniques. If the technical hurdles can be leaped, a plentitude of problems associated with other media would be solved, giving optical recording a decided boost. Optical disks will most likely appear in larger minicomputer and microcomputer applications (i.e., more demanding jobs than portable and desktop systems can now handle). Optical disk drives may not be economically practical at capacities of under 100M bytes per spindle.

Oxide-disk manufacturers will see more cost

Comparing the four most popular media demonstrates liabilities of each.

	HIGH BIT DENSITY HAS ITS PRICE			
	Media type			
	Standard oxide	High coercivity oxide	Plated	Sputtered
Drawbacks	record demagnetization	high flying height	low flying height vs. cost	availability
in				
order	low resolution	overwrite	availability	low flying height vs. cost
of				
severity	head output	peak shift	overwrite	overwrite

Pascal-2[®]

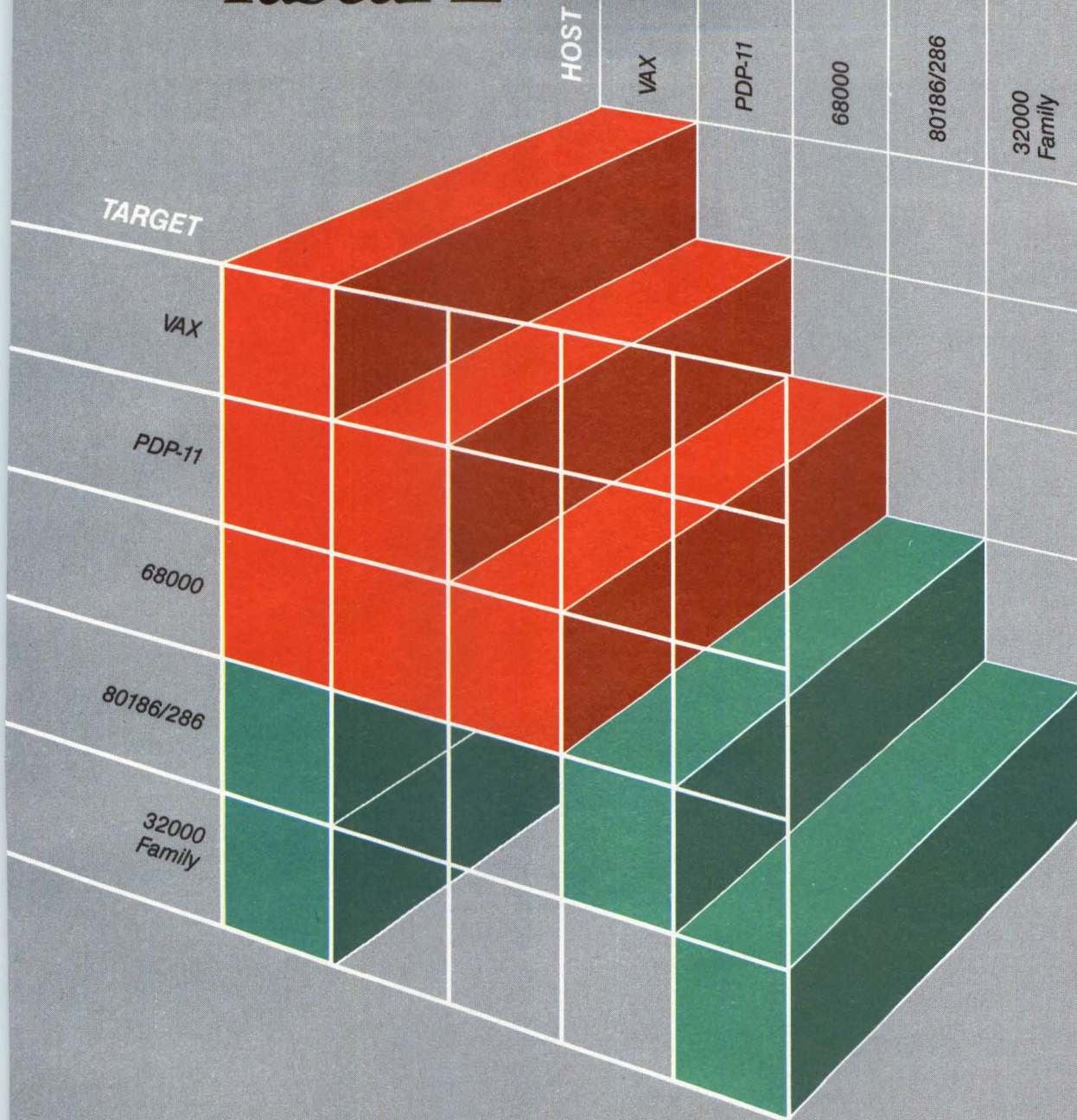

Oregon Software's matrix of cross-development tools provides high-level language solutions to low-level programming problems such as those faced by systems builders. The development language, Pascal-2, is ISO Level-1 standard, extended to do real work—the world's only certified Pascal cross-compiler. You get the portability, readability, and maintainability of a high-level language with access to machine addresses, assembly language routines and device registers. The Pascal-2 cross-development system is known for its highly efficient code generation.

Pascal-2 is becoming available on new high-performance processors (blue) in addition to our long-established markets (red), on the most popular systems, including UNIX. Using a uniform development system leads to more portable applications and less time spent retraining highly paid technical staff.

Pascal-2 and Oregon Software are trademarks of Oregon Software, Inc. PDP-11 and VAX are trademarks of Digital Equipment Corporation. UNIX is a trademark of AT&T Bell Laboratories. See us at Dexpo/West Booth No. 245

Oregon Software

Real tools for real work.

6915 S.W. Macadam Avenue
Portland, Oregon 97219

1-800-874-8501

CIRCLE NO. 43 ON INQUIRY CARD

It's easy to make points when you're a pro.

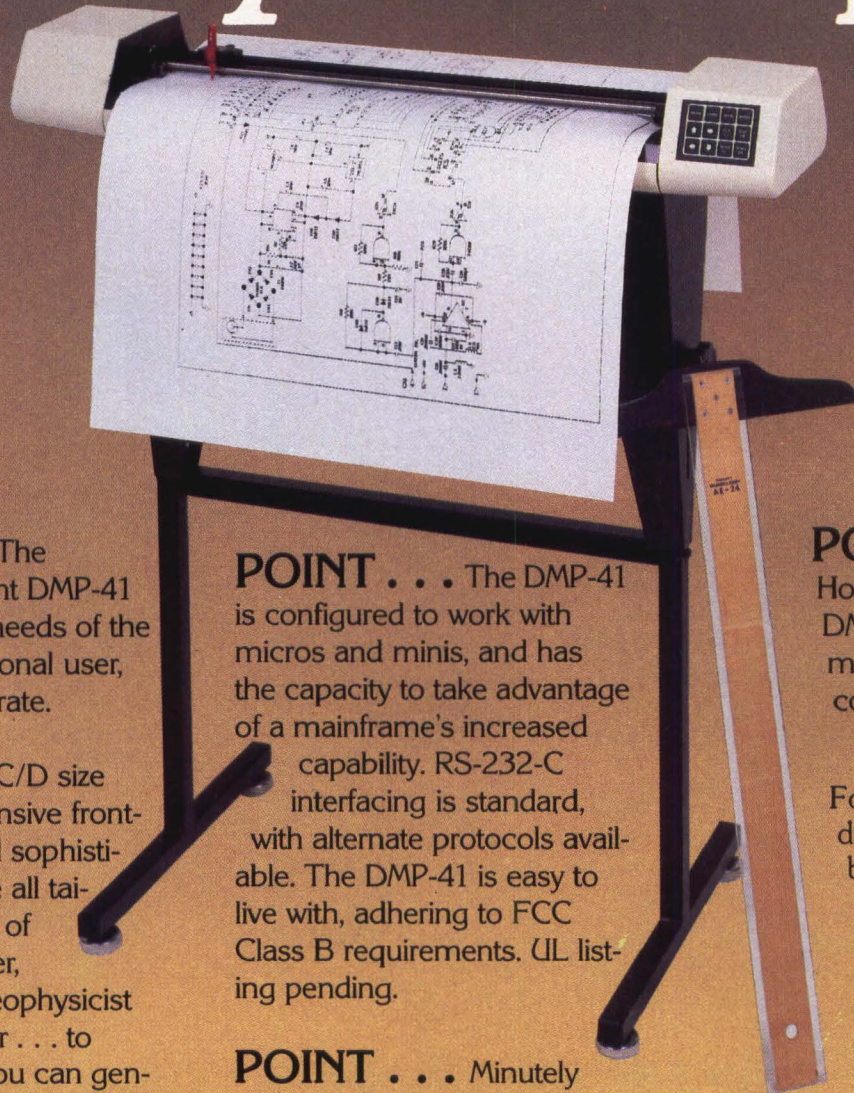

POINT . . . The Houston Instrument DMP-41 plotter meets the needs of the serious or professional user, yet it's easy to operate.

POINT . . . C/D size format, comprehensive front-panel controls and sophisticated firmware are all tailored to the needs of the surveyor, drafter, oceanographer, geophysicist and land developer . . . to name but a few. You can generate superior architectural elevations, contour maps, circuit-board layouts and assembly drawings quickly and accurately on bond, vellum or synthetic media.

POINT . . . The DMP-41 is configured to work with micros and minis, and has the capacity to take advantage of a mainframe's increased capability. RS-232-C interfacing is standard, with alternate protocols available. The DMP-41 is easy to live with, adhering to FCC Class B requirements. UL listing pending.

POINT . . . Minutely defined step size and high-resolution logic—combined with robust drives and optimized pen ballistics enable you to create plots of high precision and surpassing quality.

POINT . . . The Houston Instrument DMP-41 is one of your most cost effective considerations.*

For the name, address and phone number of your nearest representative, write Houston Instrument, P.O. Box 15720, Austin, TX 78761. Phone 512-835-0900, or

800-531-5205 if outside Texas. In Europe contact Houston Instrument Belgium NV., Rochesterlaan 6, 8240 Gistel, Belgium. Tel 059-27-74-45, tlx 846-81399.

**houston
instrument**

* suggested US retail \$3,295

CIRCLE NO. 44 ON INQUIRY CARD

SPUTTERED SPECS PROMISE PERFORMANCE

	High BPI goal	Standard oxide	High coercivity oxide	Plated with overcoat	Plated without overcoat	Sputtered
Flying height (μ in.)	≤ 10	19	14	12	13	10
Head output (μ V)	≥ 400	300	600	500	450	600
Resolution (%)	≥ 75	65	70	75	72	80
Signal/noise (dBa)	≥ 30	28	29	32	30	34
Overwrite (dBa)	≤ -30	-38	-26	-30	-29	-31

Sputtered media meets or exceeds all the specifications required to achieve the typical manufacturer's bit-per-inch goals. Plated media, with or without an overcoat, stacks up well.

competition from thin-film-media producers over the next few years. However, the oxide-media market will probably be more stable than the thin-film market because the number of manufacturers of oxide disks is small. Also, few companies are entering the field, companies producing low-capacity Winchester disk drives have no reason to change media, and new oxide-disk manufacturing techniques should reduce production costs.

Thin-film companies, though, will compete fiercely among themselves, due to the large number of manufacturers making thin-film media. The market will be segmented by cost, performance and, possibly, disk size. Companies requiring either rugged drives, removable media

or slightly higher performance will choose plated media with or without a sputtered overcoat. It is anticipated that plated media will be the most plentiful and least expensive of the thin-film media. High-capacity, high-performance disk manufacturers will most likely opt for either sputtered disks or plated disks with sputtered overcoats.

What, then, should determine the decision between sputtered or plated media? The advantages of sputtered media are:

- Better disk yield for drive applications requiring low cost and low flying height, such as that required on the inner tracks of a 3½-inch Winchester.
- The ability to sputter magnetic material on

Plated thin-film media is

produced in four stages. (1) A layer of non-magnetic nickel is plated 800 μ in thick onto an aluminum substrate. (2) The nickel surface is polished flat by a very fine abrasive material. (3) A 3- μ in magnetic layer is plated onto the nickel. (4) The disk is tested for defects and rated for commercial use.

PRODUCING PLATED MEDIA TAKES FOUR STEPS

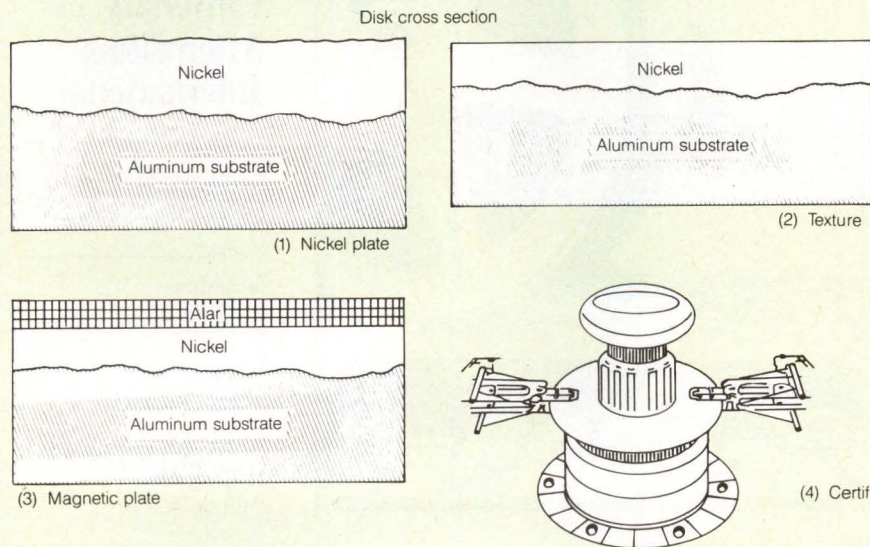

Source: Ampex Corp.

It is anticipated that plated media will be the most plentiful and least expensive of the thin-film media.

a variety of materials other than aluminum potentially provides low cost, smooth surfaces and lighter disks.

Usually, the pursuit of smooth surfaces—which enables lower flying heights—means lower production yields. However, yields are better in the manufacture of sputtered media because sputtering avoids the chemical process that creates problems for makers of plated and oxide-coated media. Instead of coating aluminum with nickel and polishing it smooth, manufacturers are making sputtered disks with glass, mylar and plastic, which are smoother to start with and do not require secondary coatings.

Lighter disks are particularly appealing to manufacturers of portable and transportable computers; supplying power to the spindle motor that turns the disk is significantly easier. The 3M SSR disk, for instance, has half the mass of other disks. That reduces by fourfold the torque requirements of the motor.

In short, as thin-film-disk technology matures, the industry will probably settle on two or three media coatings, each with a well-defined market:

high-coercivity oxide, thin-film plated with sputtered overcoat and thin-film sputtered disks.

Within the last few months, many plated-media companies have either withdrawn from the market or decided to convert to a sputtering process. For example, Poly-Disc Systems Inc. has ceased operations; Ampex Corp. and Ultra-Disc Corp. are converting to sputtering; Burroughs Disk Memory Inc. has been discontinued and SAEmag International Inc. has sub-leased its space to a sputtering company. □

Dennis D. Waid is president of Peripheral Research Corp., Santa Barbara, Calif., and was a market researcher for Freeman Associates.

Don Mann, president of the consulting company Don Mann Magnetics Inc., Newbury Park, Calif., has 22 years' experience in magnetic product development.

Interest Quotient (Circle One)
High 492 Medium 493 Low 494

This Publication is available in Microform.

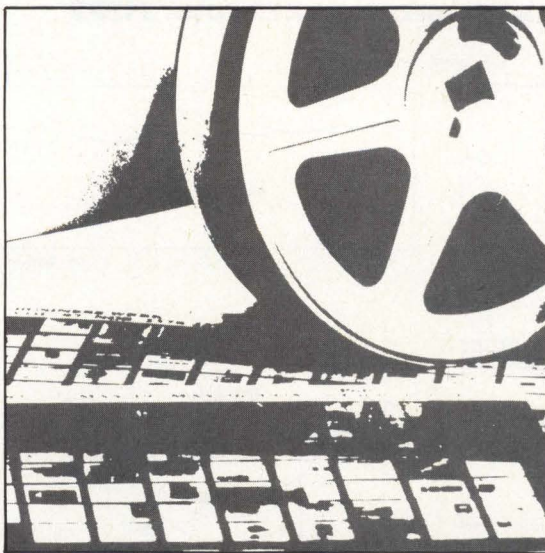

University Microfilms International

Please send additional information

for _____

(name of publication)

Name _____

Institution _____

Street _____

City _____

State _____ Zip _____

300 North Zeeb Road
Dept. P.R.
Ann Arbor, Mi. 48106

For \$400,
you've always
known what kind
of extras to expect
in a terminal.



Until

Introducing the TeleVideo® 905. High-end features at a low-end price.

Let's face it; despite most manufacturers' hype, you know what you get for \$400. A basic core terminal, a few tacked-on bells and whistles, and not much more.

All that has changed with the new TeleVideo 905.

Start with the 905's smooth, sleek design. The small footprint makes it a natural on any desk. The super-high contrast

14" flat screen offers the most readable image in the industry. And the screen tilts and swivels through a full 270° right and

High Resolut
14" Display
Flat Screen
Low-End Pric

HIGH READABILITY SCREEN

The 14" super-high resolution flat screen has more than just contrast going for it. We also put more space between the characters for even better readability.



PROGRAMMABLE FUNCTION KEYS

16 special keys let you program sets of commands into simple, single keystrokes.

At \$409, the TeleVideo 905 is the first of a new generation of "super terminals," offering an extended feature set so powerful you'd think you were sitting at an expensive workstation.

left, and from -5° to +15° up and down to reduce eyestrain, neck, and back problems.

What the screen does for the eyes, the keyboard does for the fingers. New sculptured keycaps make for smooth, comfortable typing. Sixteen non-volatile, programmable function keys eliminate repetitive keystroking. And the keyswitches have been tested to 100,000,000 strokes, five times the rating of Wyse keyboards. About the only way to improve on our keyboard would be to add an enhanced numeric keypad.

Which we did.

This functional little terminal not only fits comfortably on any desk, it fits comfortably



ENHANCED NUMERIC KEYPAD

This is the way people are used to entering numbers—quickly, smoothly, and with far less chance for errors.

The following trademarks are acknowledged: ADDS Regent 25 and Viewpoint A2—Applied Digital Data Systems, Inc.; Lear Siegler—Lear Siegler, Inc.; WYSE—Wyse Technology; Hazeltine—Hazeltine Corporation; WordStar—MicroPro International Corporation.

©1985 TeleVideo Systems, Inc.

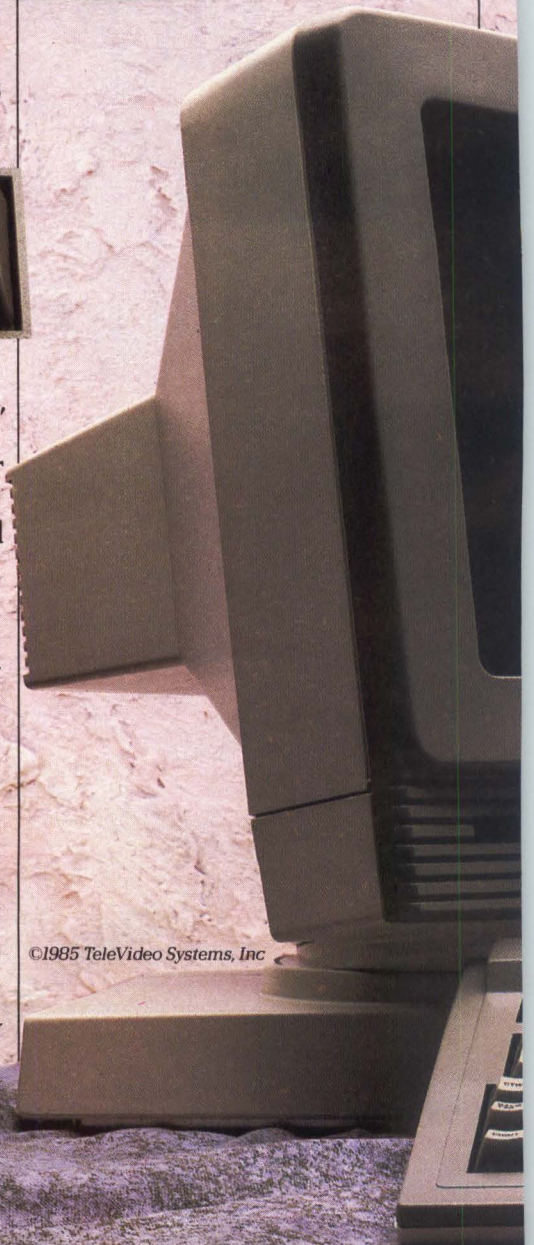

now.

into most any system, too. That's because it's compatible with the TeleVideo 925 command set, the most popular and widely emulated ASCII command set in the world. In addition, you can make your terminal think it's an ADDS Regent 25.* Or a Viewpoint A2.*



FULL TILT AND SWIVEL You can adjust the screen just about any way you want, right or left, up or down, for the maximum in-user comfort.

Or Hazeltine™, or Lear Siegler. Or a TeleVideo 910 or 910+. There's even a buffered printer port (standard), so your users don't have to sit around waiting for hard copy.

The TeleVideo 905 is the latest in a long line of quality terminals that have been shipped to over half a million users, worldwide.

And now we're making it easy for you to get your hands on a terminal that's short on

hype and long on performance. If you're a computer professional, MIS manager, or VAR, we'll send you an

evaluation unit for the special price of \$296* including shipping. (Offer ends February 28, 1986—one per company, please.) Just call 800-227-6703 and ask for department 44.

(In California, 800-632-7979.)

The high-performance TeleVideo 905. It'll change the way you think about low-priced terminals.

TELEVIDEO 905 VS. WYSE WY-30		
FEATURES	TELEVIDEO 905	WYSE WY-30
ENHANCED NUMERIC KEYPAD	YES	NO
PROGRAMMABLE FUNCTION KEYS	16	4
TILT AND SWIVEL	YES	NO
HIGH CONTRAST DARK SCREEN	YES	NO
WORDSTAR [®] MODE	YES	NO

TeleVideo[®]

TeleVideo Systems, Inc., 550 East Brokaw Road, San Jose, CA 95150-6602, (408) 971-0255
 REGIONAL OFFICES: WEST (408) 971-0255, SOUTHWEST (714) 476-0244, SOUTH CENTRAL (214) 258-6776,
 SOUTHEAST (404) 447-1231, MIDWEST (312) 397-5400, EAST (516) 496-4777, NORTHEAST (617) 890-3282
 AMSTERDAM 31.2503.35444, PARIS 33.1.687.34.40, LONDON 44.9905.6464.

*U.S. and Canada only.

CIRCLE NO. 45 ON INQUIRY CARD

Take a drive in the fast lane.

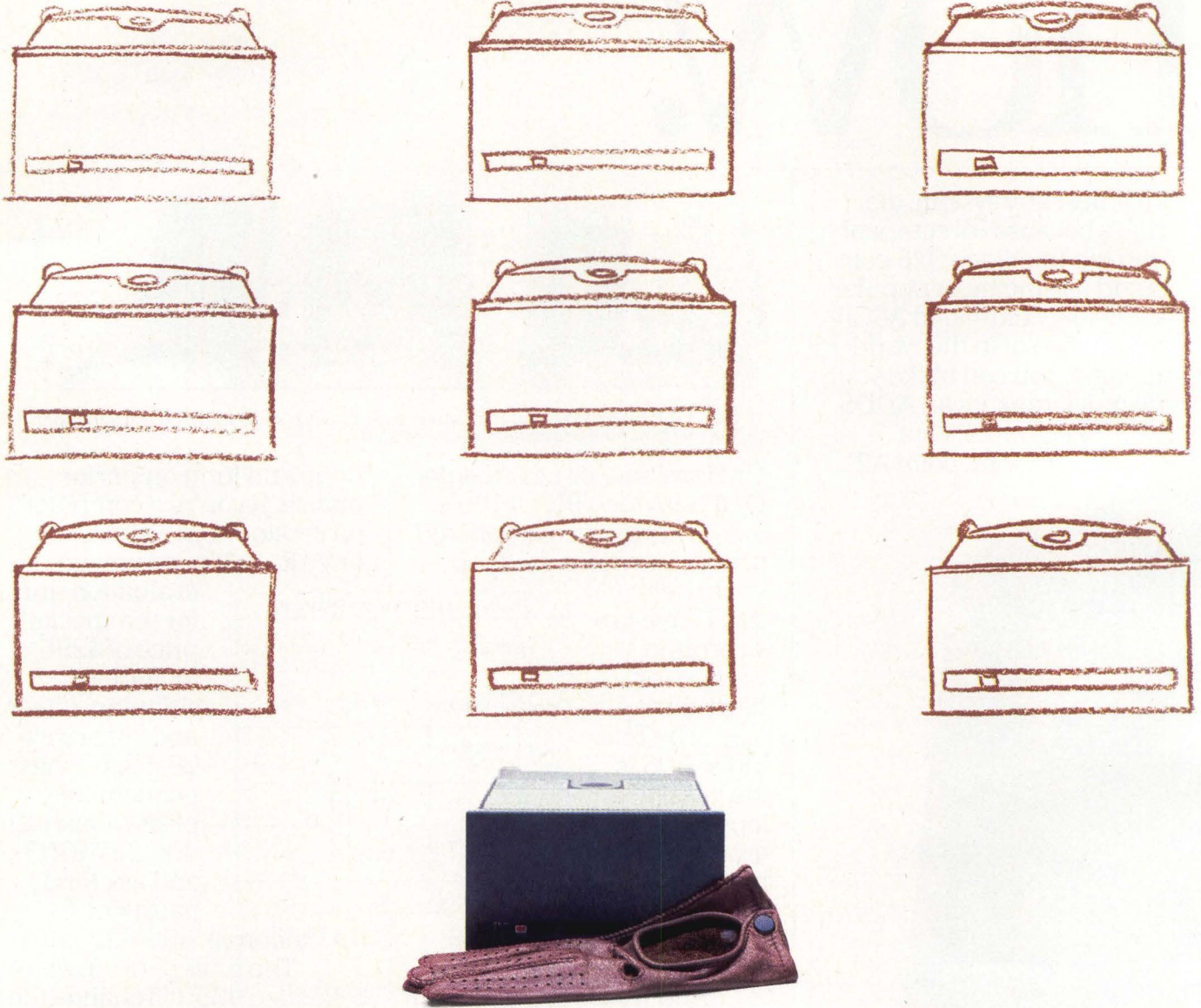

The Micropolis 1320 Series from Hall-Mark.

Cruise at top speed while improving your performance when you select the Micropolis 1320 Series 5¼" Winchester Disk Drives from Hall-Mark Electronics.

Featuring high capacities of up to 85 megabytes, super reliability and fast access times of 28 milliseconds, the Micropolis 1320 Series Winchester is fully compatible with the industry stan-

dard ST 506/ST 412 interface and is designed to perform in diverse application environments.

When you're ready for the fast lane, make Hall-Mark your nationwide source for Micropolis Disk Drives. With 32 stocking locations nationwide, we provide on-time delivery backed by technical support. Put yourself in the driver's seat. Call us for an evaluation. We're the people who care.



Alabama
Huntsville (205) 837-8700

Arizona
Phoenix (602) 437-1200

California
Bay Area (408) 946-0900
Orange County (714) 669-4700
Sacramento (916) 722-8600
San Diego (619) 268-1201
San Fernando Valley (818) 716-7300
West Los Angeles (213) 217-8400

Colorado
Denver (303) 790-1662

Connecticut
Connecticut (203) 269-0100

Florida

Fl. Lauderdale (305) 971-9280
Orlando (305) 855-4020
Tampa Bay (813) 530-4543

Georgia
Atlanta (404) 447-8000

Illinois
Chicago (312) 860-3800

Indiana
Indianapolis (317) 872-8875

Kansas
Kansas City (913) 888-4747

Maryland
Baltimore (301) 988-9800

Massachusetts
Boston (617) 935-9777

Minnesota

Minneapolis (612) 854-3223
St. Louis (314) 291-5350

New Jersey
Fairfield (201) 575-4415

New York
Long Island (516) 737-0600

North Carolina
Raleigh (919) 872-0712

Ohio
Cleveland (216) 349-4632
Southern Ohio (614) 888-3313

Oklahoma
Tulsa (918) 665-3200

Pennsylvania

Philadelphia (215) 355-7300
Texas

Austin (512) 258-8848

Dallas (214) 553-4300

Houston (713) 781-6100

Utah
Salt Lake City (801) 268-3779

Wisconsin
Milwaukee (414) 797-7844

HALL-MARK

Hall-Mark Electronics Corp. • Dallas, Texas • Subsidiary of Tyler Corp.

CIRCLE NO. 46 ON INQUIRY CARD

© 1985 Hall-Mark Electronics Corp. 0232-1000

MINIS GAIN ON SUPERS WITH VECTOR PROCESSORS

With architectures similar to the Cray 1, systems can perform like supercomputers in demanding applications at supermini prices

Frank Marshall, Steve Wallach and Harold Dozier, Convex Computer Corp.

Seymour Cray founded Cray Research Inc. in 1972 and introduced the Cray 1 in 1976. It and other supercomputers have been powerful additions in the computer lineup. But they also have been extremely expensive. As a result, there has been considerable interest among designers in developing a system that would possess supercomputer-like architecture, yet cost in the range of superminicomputers. Such a system would establish a new category of computer—one bridging the gap between traditional supercomputers and superminicomputers. These machines perform like supercomputers in such demanding applications as computer-aided design, simulation and verification. Moreover, they would be powerful associates of both smaller and larger computers. For example, instead of using a scalar processor as a front end for a Cray, users could employ a relatively inexpensive Cray-like system. Instead of offloading computation from a superminicomputer to a Cray, users might send them to a "bridge" machine.

Architecture defines differences

The truly distinguishing characteristics between supercomputers and superminicomputers are architectural. Superminicomputers are 32-bit scalar machines, which means they can only process one arithmetic element—single-instruction, single data (SISD)—at a time. To process a set of four such elements would require four separate operations.

Supercomputers are capable of handling 64-bit vector processing, whereby four problems can be handled in a single operation—i.e., single-instruction, multiple data (SIMD).



With an architecture that closely models that of the Cray 1, the Convex C-1 creates a new category of machine: one fitting between superminicomputers and supercomputers.

Pipelining is another architectural aspect of supercomputers. Many computers execute instructions one at a time, completing all of the steps for each instruction before beginning to work on the next. A pipelined system, however, will handle the different steps of several sets of instructions simultaneously. The result is that it takes much less time to execute a set of instructions in a pipelined system than it does in a sequential type.

The C-1 posts a score of 60 megaflops, where the Cray 1 scores 140.

One machine which boasts supercomputer characteristics, but which is priced like a super-minicomputer, is the C-1 from Convex Computer Corp., Richardson, Texas. The C-1 is a virtual-memory, Cray-like processor, including 64-bit data paths and vector accumulators. Because of its Cray-like architecture, all algorithms common to the Cray are directly applicable to the C-1. The Convex compiler performs integrated vector processing through a dual-pipe design and is highly pipelined for added scalar and vector processing speed. Moreover, like a Cray 1, it has a physical memory of 128M bytes.

Architecture resembles Cray machines

Using a dual-pipe design, the C-1 performs pipelined numerical operations on vectors, the same kind of operations characteristic of the Cray 1 and the similar Cyber from Control Data Corp., Minneapolis, Minn. The system includes a vectorizing FORTRAN 77 compiler. With it, users can take FORTRAN source code written for operation under the VMS operating system supplied with Digital Equipment Corp.'s VAX 32-bit minicomputer line, and recompile it immediately for execution. In addition, the com-

piler extracts any opportunities for vectorization (as in parallelism) and generates vector instructions for those portions. The more opportunities for vectorization, the faster a program will execute.

In addition, the compiler provides global optimizations through such techniques as constant folding and propagation, strength reduction, code motion, dead-code removal and instruction scheduling.

Vector optimizations, perhaps the most advanced features of the compiler, include vectorization for all nested loops, loop interchanges, generation of bit conditionals, recognition of reduction operators and partial vectorization. These attributes, along with the operating system development features, plus a symbolic debugger, provide a highly interactive development environment.

The C-1 in operation

One of the drawbacks to using supercomputers is the dearth of people with supercomputer experience. Thus, while prospective users go through their learning curve, an expensive system may remain under-utilized.

When designers have attempted to add vec-

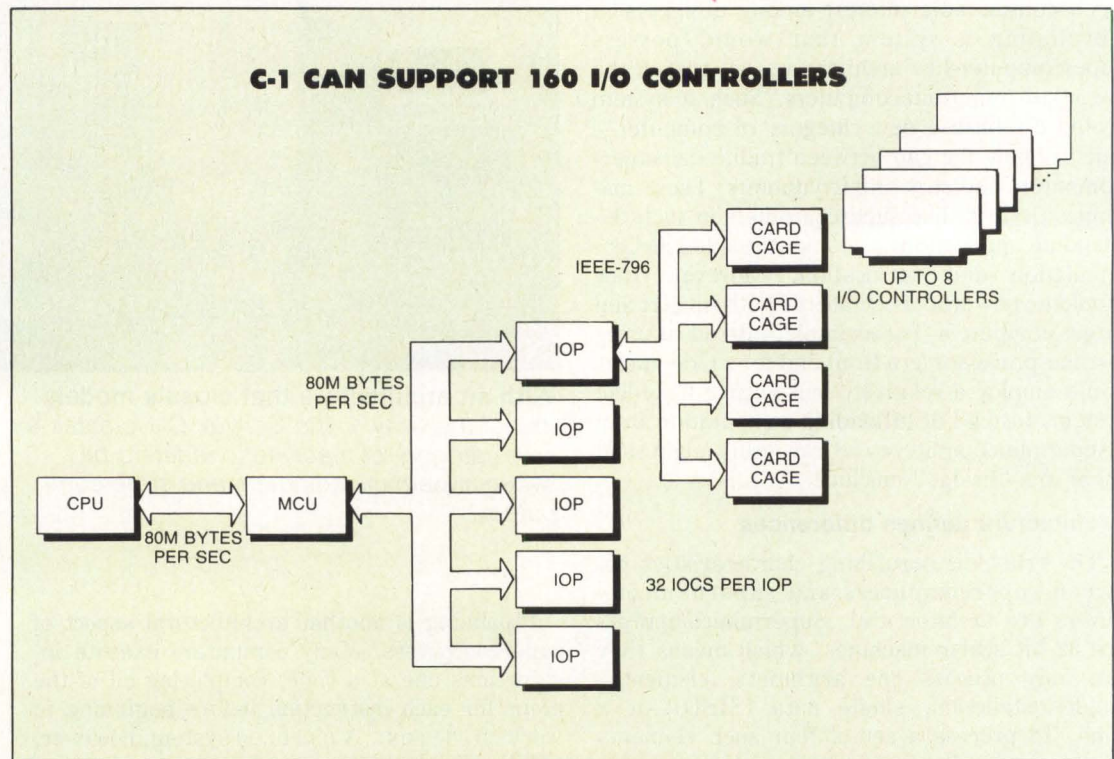

The distributed-processing architecture of the C-1 permits up to 160 I/O controllers to be attached to the system. The intelligent I/O processors (IOPs) can each control four

card cages with up to eight I/O controllers, for a total of 32. The system will support up to five IOPs on its central bus.

If all you want is a disk drive, you're looking at the wrong ad.

At long last, a few companies have figured out how to make Winchester drives like Maxtor's. But they still haven't figured out how to duplicate the company that makes Maxtor drives.

Which makes all the difference.

You see, every drive we sell comes with a partnership. We work with you as your product takes shape. Your requirements become ours. Your deadlines become our deadlines. Even our new products are developed in response to your expressed needs.

That's how we became the leading manufacturer of the highest quality, highest capacity 5¼-inch drives. And that's how we'll keep our lead. Because what you're buying isn't just a disk drive.

It's a company.

Maxtor Corporation, 150 River Oaks Parkway, San Jose, California 95134, (408) 942-1700, TELEX 171074. Eastern Regional Sales Office: (617) 872-8556. Southwest Regional Sales Office: (714) 859-3100.

Maxtor

CIRCLE NO. 47 ON INQUIRY CARD

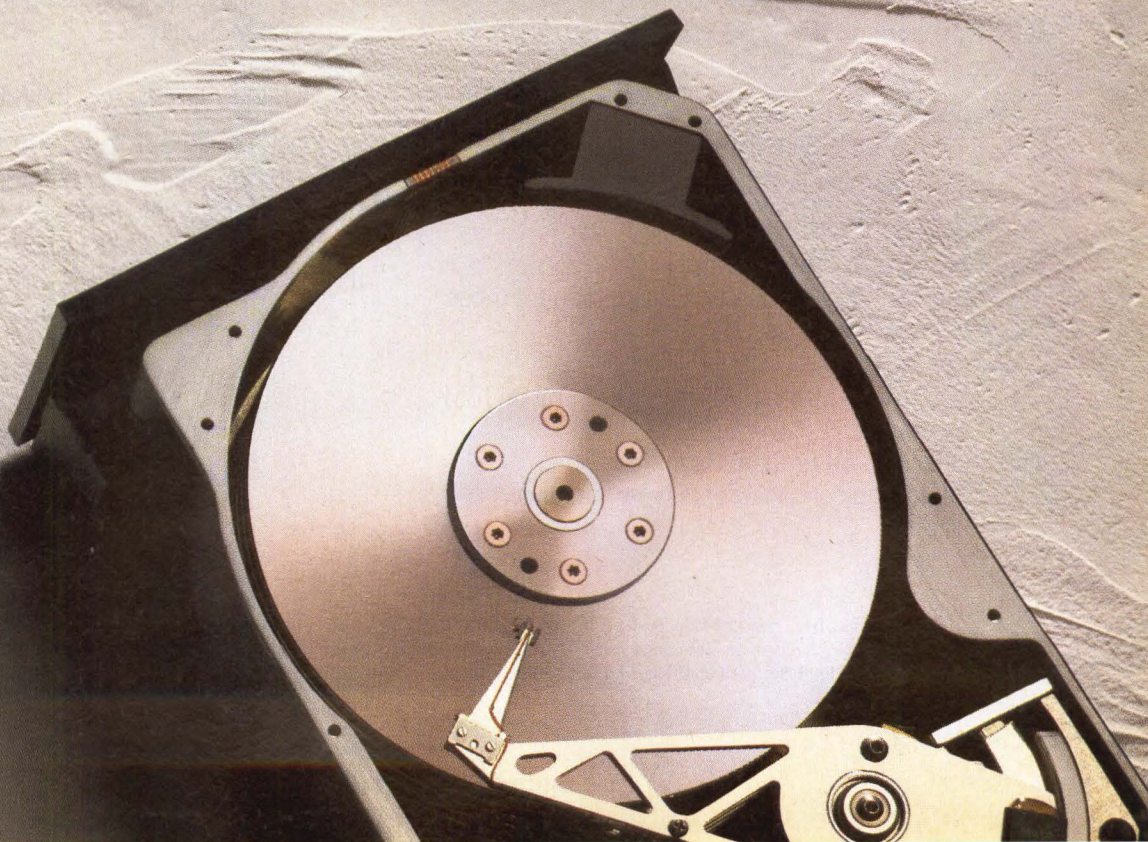



On November 18, 1985, at SIGAda in Boston, ALSYS opened the doors to Ada . . .

With Ada compilers for 15 computer models

Apollo Domain DN300, DN320, DN330, DN400,
DN460, DN550, DN600, DN660.
SUN Workstations 2/50, 2/100, 2/120, 2/160, 2/170.
Hewlett-Packard 9000, Series 200, 300.

With an Ada cross-compiler

DEC VAX 11/730, 11/750, 11/780, 11/785, and MicroVAX I
Cross-Compiler to Altos ACS 68000.

With Ada training products

You Know Fortran—Ada is Simple
(12 Lesson Computer-Aided Instruction for those
who know Fortran.)

Lessons on Ada

(2-Volume, 27 lesson CAI course running on IBM-
PC and VAX.)

Ichbiah, Barnes and Firth on Ada

(27 video tape overview of Ada by language
designers.)

With Ada programming tools

AdaQuery

(Complete, searchable on-line Ada Language Refer-
ence Manual.)

AdaViewer

(Unique viewing tool for Ada programmers.)

With more compilers in development

IBM-370 Compiler under development at Alsys Ltd., U.K.

Hewlett-Packard 1000 Series A900 Compiler under de-
velopment at Alsys Ltd., U.K.

IBM-PC/AT and IBM-PC/XT Compilers under develop-
ment at Alsys, Inc., U.S.

Alsys, Inc. • 1432 Main Street • Waltham, MA 02154 • U.S.A. • Phone: (617) 890-0030 • Telex: 948536

Alsys, S.A. • 29, Avenue de Versailles • 78170 La Celle St. Cloud • France • Phone: (3)918.12.44 • Telex: 697569

Alsys, Ltd. • Partridge Hse, Newton Road • Henley-on-Thames • Oxon RG9 1EN, England • Phone: (0491) 579090 • Telex: 846508

© Ada is a registered trademark of the U.S. Government (AJPO).

CIRCLE NO. 48 ON INQUIRY CARD

tor processing capability to superminicomputers by linking them to attached array processors, they've often made that problem worse. The machines so produced were admittedly superior to an average superminicomputer in performance, but they were also far more complex. Where before, a user's time was sacrificed to learning one set of instructions, now it was lost on two.

With the C-1, however, users face a single, homogeneous interface. They deal with familiar languages, operating systems and network and interface standards from the onset. The operating system is UNIX 4.2 Berkley version and users have their choice of programming languages, such as FORTRAN and C.

A single instruction set covers scalar and vector processing. A single FORTRAN compiler permits existing FORTRAN programs to run with varying levels of increased throughput. That same compiler extracts instances of parallelism and processes them vectorially.

Even FORTRAN programs that do not have inherent parallelism will run on the C-1. Its scalar-processing capabilities are at least equal to, and often exceed, the fastest superminicomputer.

Indeed, a measure of supercomputer performance is the number of floating-point operations that can be done per second. For supercomputers, the scale starts in the millions of floating-point operations per second (megaflops). Superminicomputers do not even tip the scales at half a million, but the C-1 posts a score of 60 megaflops where the Cray 1 scores 140.

System I/O, meanwhile, involves intelligent distributed processing. That is, the CPU is relieved of mundane I/O overhead by a system of I/O processors (IOPs). Each has its own 32-bit microprocessor plus local cache memory. The processors accept high-level commands from the CPU and handle all of the underlying I/O tasks.

A C-1 may have as many as five IOPs connected to its 80M-byte-per-second central bus. Each can control up to four card cages, and each card cage may have up to eight I/O controllers. A fully-configured C-1 can thus support up to 160 I/O controllers. The I/O processors are packaged on IEEE-796-compatible printed-circuit boards. The card cages are Multibus 1 types so that users might have access to the scores of controllers sold by the many long-established Multibus-system vendors.

The system provides networking so that Convex systems can communicate with one another, or with other vendors' systems that subscribe to the same network protocols (TCP/IP).

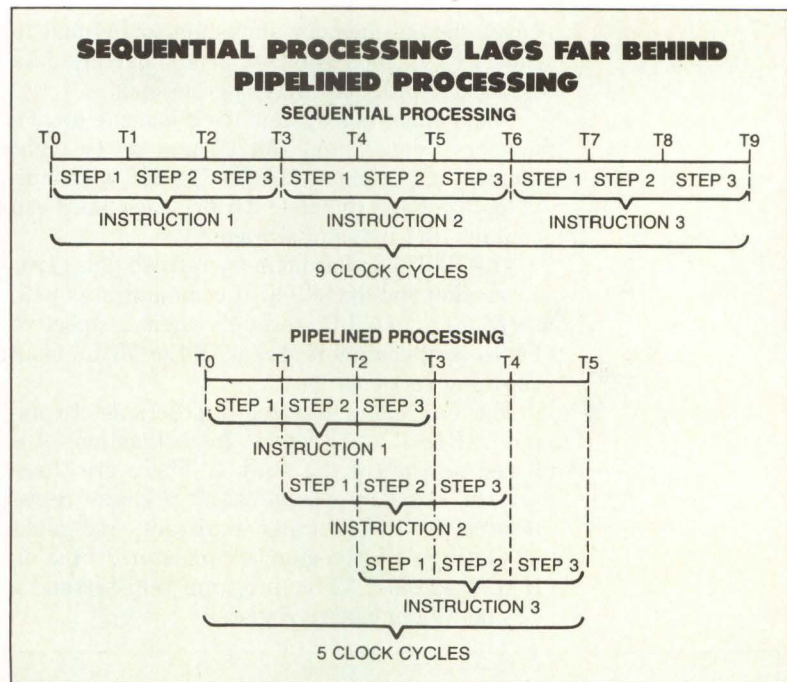

In sequential-processing systems, each instruction is completed before the next one is begun. In a pipelined system, there is overlapping of instructions. It takes five-ninths as long to execute the three instructions in the pipelined system as it does in the sequential type.

The C-1 may thus support information and resource sharing, remote batch processing, computational servers and electronic messaging.

Finally, the C-1 contains a service processor unit (SPU) to handle system failures. The SPU is an independent unit with its own memory, tape and disk subsystems. It can perform serial scans on each system board, applying test patterns and then retrieving and analyzing results. It monitors parity checking of data paths, buses and CPU registers. By quickly identifying which board is at fault, the SPU greatly reduces the time needed to repair the system. Indeed, because the system allows boards to be removed or inserted while it is functioning, repairs can be done in minutes that might have otherwise taken hours.

Divided into three subsystems

Three main subsystems make up the C-1's hardware: the CPU, I/O and memory. Memory is dual-ported. One port is for direct-memory access by the I/O subsystem; the other is for CPU/memory transfers. Separate high-speed

buses tie the memory subsystem to I/O and to the CPU. Each is 64 bits wide and handles data traffic at up to 80M bytes per second.

The memory subsystem itself is made up of a memory control unit (MCU) and up to eight memory array units (MAUs). Loaded with individual 256K-bit dynamic RAMs, each MAU can contain 16M bytes of storage.

The MCU handles memory refresh plus error correction and detection. It communicates with the CPU and I/O through their respective buses, and communicates with the MAUs via a third bidirectional bus.

The C-1 has a reduced-instruction-set-computer (RISC) architecture. Its instruction set is based on that of the Cray 1. There are three sets of registers—eight 32-bit address registers; eight 64-bit scalar registers; and eight 128-bit-by-64-bit vector accumulators. In addition, there is a 32-bit program register and a 128-bit vector-merge register.

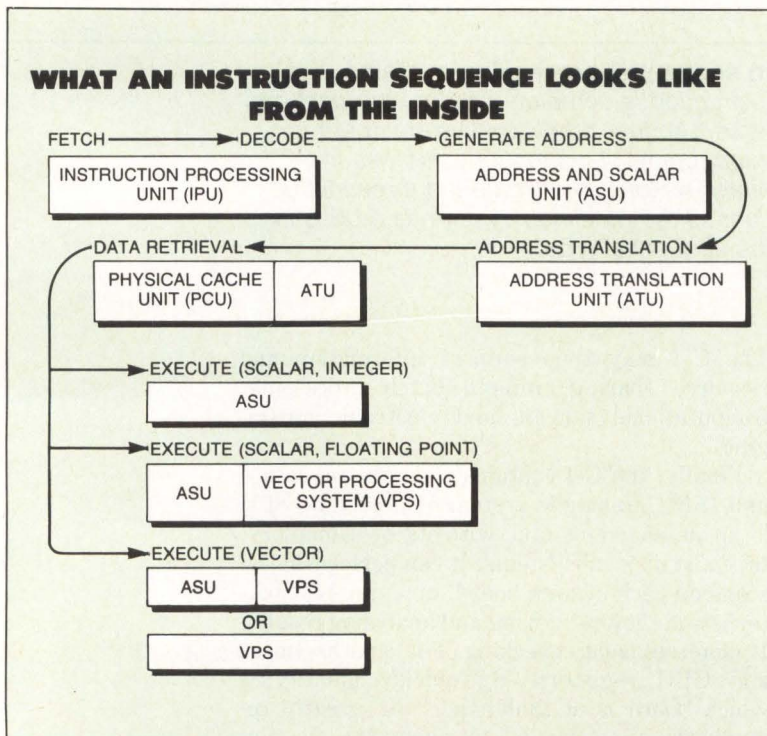

Beginning with a fetch, the diagram shows a typical sequence of operations and the CPU areas that are involved. In some cases, execution may follow immediately after address generation (where the execution involves register-to-register processing). Execution involves just the ASU, or a combination of ASU and VPS, or just the VPS, depending on the data types to be processed.

Register-to-register instructions are 16-bits long; those involving data memory references are either 32- or 48-bits long. Vector instructions are complete and orthogonal and support addition, subtraction, multiplication and division plus vector-compare logic.

The C-1's I/O subsystem supports both block-oriented transfers, such as disk reads and writes, plus character-oriented transfers, like those between systems and terminals. The I/O system is based on a virtual-channel abstraction which makes it easy to attach and integrate other I/O controllers to the C-1. The 68000-based I/O processors have their own software kernel whose utilities permit physical device-drivers on the processor to handle Multibus controllers in attached card cages. The kernel also supports communications among the system's virtual channels.

The C-1's CPU consists of five, asymmetric parallel processors: an instruction processing unit (IPU), an address and scalar unit (ASU), a vector processing system (VPS), an address translation unit (ATU) and a physical cache unit (PCU).

The IPU handles instruction fetch and decode. If the operation is simply register-to-register, then execution is handled by either the ASU or a combination of ASU and VPS, depending upon the nature of the data types. If the operation involves memory, then the ASU must generate the address after it has been decoded (by the IPU). The translation from logical to physical addresses is done by the ATU, then data is retrieved either from physical cache or memory.

These steps are done in a parallel/pipeline fashion. Thus, while the system is fetching the third instruction, it is decoding the second, and generating the address for the first, simultaneously. Up to eight instructions may be "in the pipe" at the same time. Regardless of whether the operation is scalar or vector, it gains a performance advantage via pipeline processing.

In vector operations, not only are the instructions processed in pipeline fashion, but also are carried out on a modified-data-flow, execute-when-ready basis called "chaining." For example, where a program calls for two vectors to be loaded to two vector registers, and then added, the add operation begins as soon as each vector element is ready, instead of waiting until all elements have been loaded. The concept is similar to pipelining except that it happens on an operand rather than an instruction basis.

The VPS consists of three independent, microprogrammed processors. One handles load/store/vector edit execution, the second does

Kimtron

MULTI-USER SOLUTION for IBM PC, XT, AT

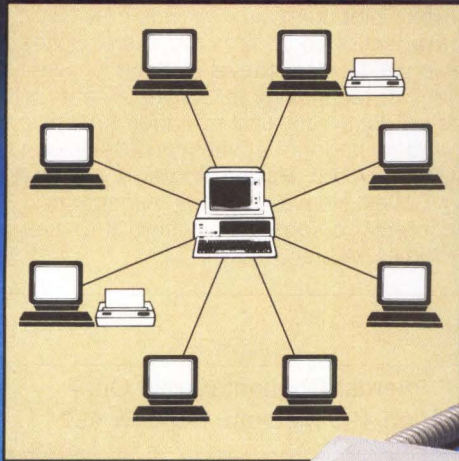

Compare the Solution!

The Multi-User Solution of the future is now available.

Convert your IBM PC, XT, AT or Compatibles to a true multi-user system while maintaining display, keyboard and software compatibility.

Since the KT-7/PC display is the same as your PC monochrome monitor, with its look-alike keyboard, operators will feel they're using an IBM PC and can also use the same software manual. Kimtron's multi-user solution includes file and record locking, shared data access, and communication between users. It is **the** intelligent alternative.

The KT-7/PC supports Time Sharing, Enhanced Time Sharing

and Multi-Processor implementation under PC DOS, MS DOS, UNIX, XENIX, CPM 86, Multilink, Concurrent PC DOS, and other compatible multi-user operating systems.

Kimtron's multi-user solution may be tailored for cost effectiveness; as low as \$1095 for an additional user, and for speeds more than ten times faster than LAN. You can add one or as many as 31 additional users per PC. Kimtron delivers the future now by allowing an ever-widening network of multi-user PC's.

The KT-7/PC may be complemented with one (or more) I/O Card, Memory Card, 8086 Speed

Enhancer Card, 80286 AT Card, 8088 Multi-Processor Card, 80186 Speed Enhancer Card, 68000 Card, and related software.

For more information about Kimtron's Multi-User Solution, or general video data terminals for other mini or micro multi-user systems, call your local computer dealers, distributors or Kimtron Corporation Today!

Kimtron Corp.
1705 Junction Court
Building 160
San Jose, CA 95112
408-286-8790
TWX: 910-338-0237



NOTE: IBM PC, XT, AT, PC DOS, MS DOS, UNIX, XENIX, CPM 86, Multi-Link, Concurrent PC DOS are registered trademarks of IBM Corporation, Microsoft Corp., Bell Labs., Digital Research Inc., Software Link Inc. respectively.

CIRCLE NO. 49 ON INQUIRY CARD

Spec summary

- **Company:** Convex Computer Corp., Suite 151, 1819 Firman, Richardson, Texas 75081
- **Model:** C-1
- **Word size:** 64 bits
- **Real memory:** 128M bytes
- **Virtual memory:** 4G bytes
- **I/O bandwidth:** 80M bytes per second
- **Size:** 24 cubic feet
- **Cost:** \$500,000

vector additions and subtractions, and the last performs vector multiplication and division. Chaining can take place even in mixed operations involving all three VPS processors.

The VPS can attain execution levels up to 60 million operations per second for 32-bit data and 30 million operations per second for 64-bit data. Concurrently with VPS execution, the C-1 also executes integer operations and branches. The VPS also offers a rich set of vector primitives.

All arithmetic functions apply to integer and floating-point calculations.

A complete set of vector edit instructions—mask, merge and compress plus gather/scatter and vector-compare instructions permit vector conditional operations, sorts and merges and operations on spare matrices. □

Frank Marshall is vice president of development at Convex Computer Corp. He was previously vice president of computer products at United Technologies Mostek. **Steve Wallach** is vice president for technology at Convex. Prior to this, he was product marketing manager at Rolm Corp. and manager of advanced development at Data General Corp. **Harold Dozier** is manager of VLSI at Covex. He was formerly manager of microcomputer components design at United Technologies Mostek.

Interest Quotient (Circle One)
High 495 Medium 496 Low 497

Little Board™/186... \$495

High Performance, Low Cost PC-DOS Engine

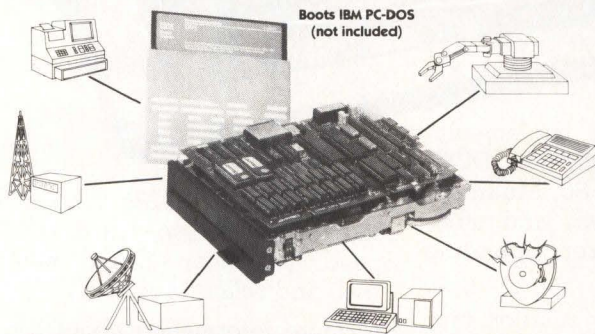

- Boots IBM PC-DOS (not included)
- Three times the COMPUTING POWER of a PC
 - Data and File Compatible with IBM PC, runs "MS-DOS generic" programs
 - 8 MHz 80186 CPU, DMA, Counter/Timers, 128/512K RAM zero wait states, 16-128K EPROM
 - Mini/Micro Floppy Controller (1-4 Drives, Single/Double Density, 1-2 sided, 40/80 track)
 - 2 RS232C Serial Ports (50-38, 400 baud), 1 Centronics Printer Port
 - Only 5.75 x 7.75 inches, mounts directly to a 5-1/4" disk drive
 - Power Requirement: +5VDC at 1.25A; +12VDC at .05A; On board -12V converter
 - Software Included:
 - PC-DOS compatible ROM-BIOS boots DOS 2.x and 3.x
 - Hard Disk support
 - OPTIONS:
 - Expansion board with:
 - 128 or 512K additional RAM
 - 2 Sync/Async RS232/422 serial ports
 - Battery backed Real Time Clock
 - 8087 Math Co-Processor
 - Buffered I/O Bus
 - STD Bus Adapter
 - Utilities source code
 - TurboDOS / Networking



IBM®, IBM Corp.; 80186®, Intel, Corp.; Turbo DOS®, Software 2000, Inc.

67 East Evelyn Ave. • Mountain View, CA 94041 • (415) 962-0230 • TELEX 4940302

9-TRACK MAG. TAPE SUBSYSTEM FOR THE IBM PC/XT/AT



For information interchange, backup and archival storage, IBEX offers a 9-track, IBM format-compatible 1/2" magnetic tape subsystem for the IBM PC, featuring:

- 42 M-Bytes on a single reel.
- IBM format 1600 cpi.
- Software for PC-DOS, MS-DOS.



IBEX COMPUTER CORP.
20741 Marilla St.
Chatsworth, CA 91311
(818) 709-8100
TWX: 910-493-2071

Write, phone or TWX for information

CIRCLE NO. 50 ON INQUIRY CARD

CIRCLE NO. 51 ON INQUIRY CARD

The Firebreathers continue on the cutting edge of high performance computers.

The most powerful line of computer systems made. Gould PowerNodes™ and CONCEPT/32s®

Any way you slice it they beat the VAX™

Our main-frame PN9000 and CONCEPT 32/97

are up to twice as fast as the VAX 8600.

And even though the mid-range PN6000 and CONCEPT 32/67 are 30-50% smaller than the VAX 11/780, they're still up to three times more powerful.

More power for a slice of the price.

Despite their superior power, our mid-

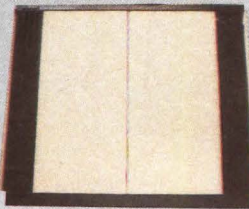

range models cost 40% less than the VAX 11/780. Our mainframes cost about 30% less than the new VAX 8600. The bottom line is more power for less money.

Operating environments that are a cut above the rest.

There's also a choice of system software to consider. Gould's unique UTX/32® is the first operating system to combine UNIX* System V with Berkeley BSD 4.2. So it allows you to access virtually any command format you want whenever you want.

And in real-time environments, Gould's MPX/32™ operating system offers performance that's unmatched in the industry, as well.

Delivery that's right on the mark.

Unlike the VAX 8600, that has up to a 12 month wait for delivery, when you

order either a Gould PowerNode or a CONCEPT/32 system, they'll be shipped within 90 days ARO.

You can also be sure with Gould you're getting a computer that's backed by years of experience—the kind of experience we used to develop the first 32-bit real-time computer.

If you need more information or just have a few questions, give us a call at 1-800-327-9716.

See for yourself why VAX no longer cuts it. Go with a Gould computer and ax the VAX.

CONCEPT/32 and UTX/32 are registered trademarks and PowerNode and MPX/32 are trademarks of Gould Inc. VAX is a trademark of Digital Equipment Corp. UNIX is a trademark of AT&T Bell Labs.



Only Gould computers have a big enough edge to ax the VAX.

CIRCLE NO. 52 ON INQUIRY CARD



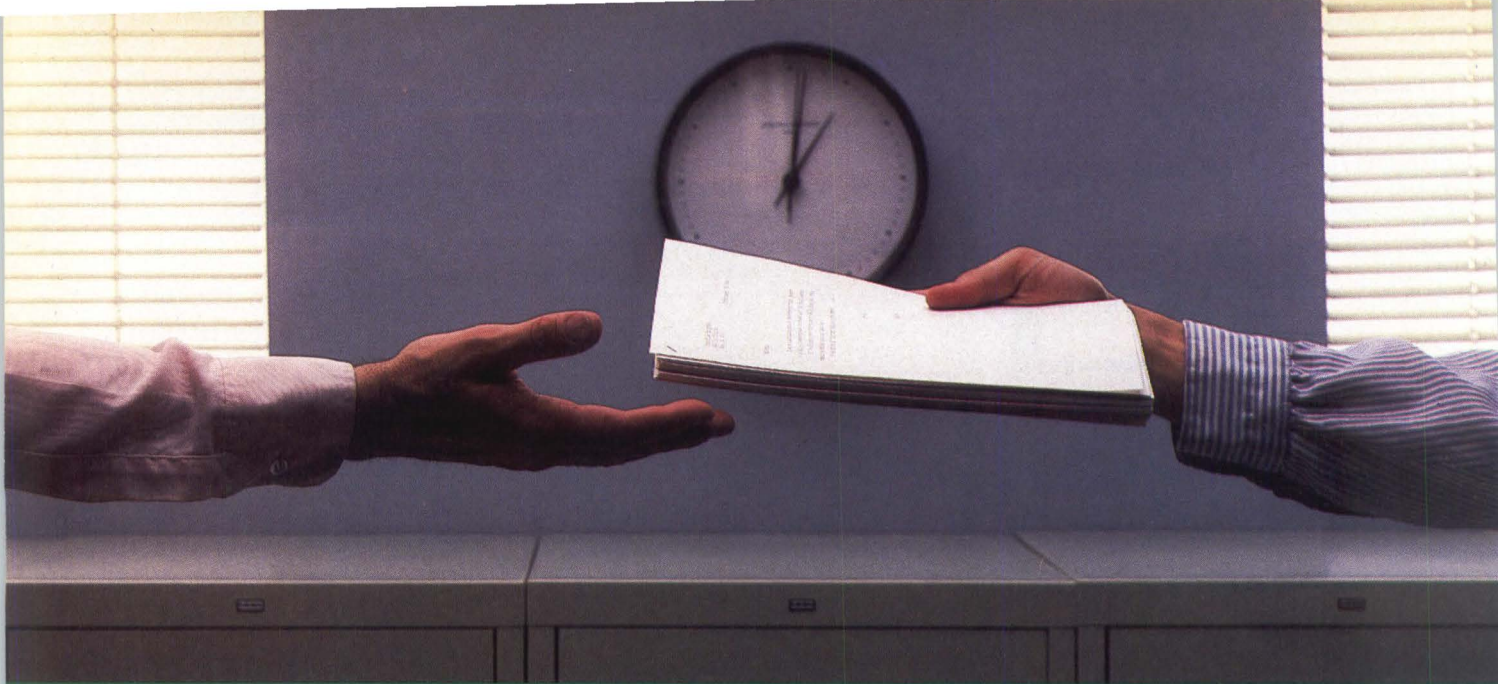

2400 bps modems: Do you Really need another speed?

- Is the shift from 300 to 1200 bps going to repeat itself at 2400 bps? The answer is both yes and no. There certainly are applications for 2400 bps asynch dial-up modems, but we shouldn't expect 1200 bps to die overnight.
- 2400 bps modems can improve throughput, thereby getting tasks done quicker and more economically. However, 1200 bps has become the virtual standard for professional dial-up communications, and most users are satisfied with it. So why consider a 2400 bps modem at all?
- One reason is flexibility. If the modem you select operates at all three speeds (300, 1200 & 2400) in accordance with accepted industry standards, it will serve virtually all dial-up applications now and in the foreseeable future.
- The modem you select should be the MultiModem224. It is Bell 212A and 103 compatible at 1200 and 300 bps, and CCITT V.22bis compatible at 2400. It is also 100% compatible with the Hayes command set, meaning that it will work with virtually all communications software packages, at all three speeds. Other features include both synchronous and asynchronous operation, full intelligence and a phone number memory.
- The MultiModem224 is available in both desktop and IBM PC™ internal card versions. (There is also a rack-mounted version for central sites.) And as a bonus, we provide free offers from ten of the most popular on-line information services, including CompuServe™, Dow Jones™ and The Source™.
- A 2400/1200/300 bps modem is just a plain good investment. Why not let the MultiModem224 provide your communications for both today and tomorrow?

For more information, call us toll-free at
1-800-328-9717 (in Minnesota, call 1-612-631-3550).

CIRCLE NO. 53 ON INQUIRY CARD

MultiTech 
Systems

The right answer every time.

82 Second Ave. S.E., New Brighton, MN 55112 (612) 631-3550, TWX: 910-563-3610

MultiTech 
Systems

MultiModem 224
2400/1200/300 BPS Intelligent Modem

1200
300 Ans

NEW PRODUCTS

DISK/TAPE

Eileen Milauskas, Assistant Editor

Tape backup suits IBM PC/AT

- Menu-driven
- 20M-byte storage
- Two backup modes

A half-height, internal streaming-tape backup unit, the ST/20 copies from a 20M-byte, Winchester hard disk drive in 5 minutes. IBM PC, PC/XT and PC/AT-compatible, the drive operates in mirror-image or file-by-file data backup or retrieval mode. The unit's software works with either MS-DOS or PC-DOS; all functions are menu-driven. \$795. **Magnetic Memory Corp.**, 2550 Ninth St., Berkeley, Calif. 94710, (415) 548-3448.

Circle 299

Tape drive uses single-axis head positioning

- Automatic gain control
- 20W operation
- 60M-byte storage

The same size as a 5¼-inch, flexible disk drive, the RoadRunner quarter-inch, cartridge streaming-tape drive for disk backup applications stores 60M bytes. A single-axis head-positioning feature eliminates head-registration problems and assures reliable interchange of cartridges and drives. An automatic-gain-control feature allows data to be read even on marginal tape cartridges. Operating in streaming mode, the drive can implement start/stop applications. A cartridge-loading scheme moves the cartridge into a mounted head which then steps only vertically to locate the proper track, decreasing the amount of registration errors. Employing CMOS circuitry, the drive consumes 20W running at a 100 percent duty cycle. It incorporates a servo design utilizing a brushless, DC motor. The drive provides a BSTI or QIC-36 interface. With

an optional formatter/controller, it interfaces to QIC-36 on the input and QIC-02 on the output and records in a QIC-24 format. \$500, Q1000. North

Atlantic Qantex, 60 Plant Ave., Hauppauge, N.Y. 11788, (516) 582-6060.

Circle 300

ONE-STOP ARCnet™ LAN SOLUTIONS

Now you can get all the tools you need to build industry standard **TOKEN-PASSING** networks from one source. InterContinental Micro.

Our networking packages let you configure any combination of nodes (PCs and compatibles, ATs, XTs, Jrs., Z-100s) to a common Fileserver in just a few minutes with our menu-driven installation program.

Active and passive hubs allow you to integrate up to 255 users on a single network with *increased* efficiency as the network grows.

In addition, our stand-alone ARCnet™ Workstation/Fileserver and complete line of S-100 Bus products (single board computers, slaves and controllers) give you and your customers even more options.

We're also compatible with other industry-leading ARCnet PC™ and S-100 products, and our PC networking boards include an optional 256K of system RAM.

All with InterContinental Micro's reputation for outstanding reliability, exceptional service, and highly competitive pricing.

Call InterContinental Micro today, or circle the bingo number below for ARCnet™ LAN solutions.



4015 Leaverton Court, Anaheim, CA 92807; Phone: (714) 630-0964
Telex: 821375 SUPPORT UD; Easylink: 62562040.

ARCnet is a trademark of Datapoint Corporation.

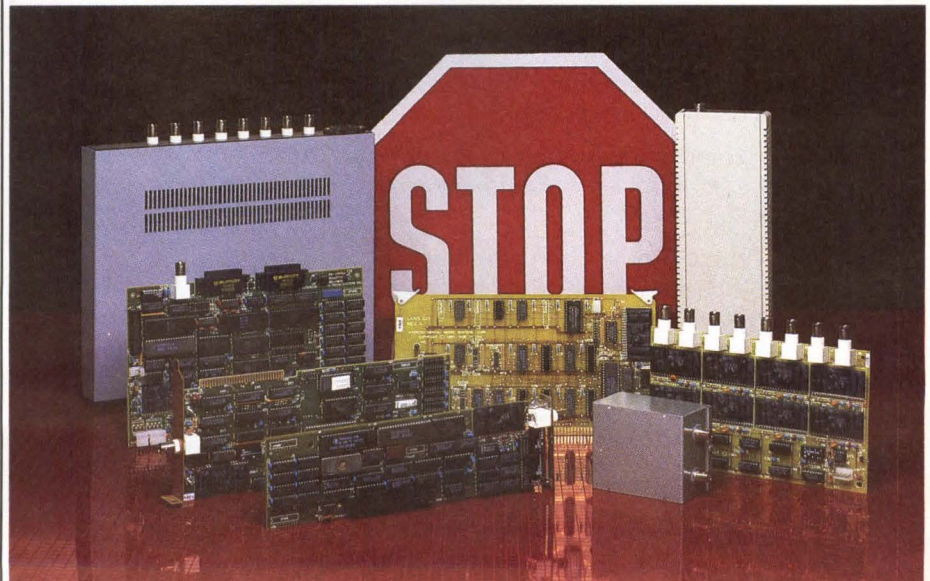

CIRCLE NO. 54 ON INQUIRY CARD

MegaRam Disc Emulator

Revolutionary, Non-rotating,
Solid-state Replacement for
Fixed or Moving Head Discs.

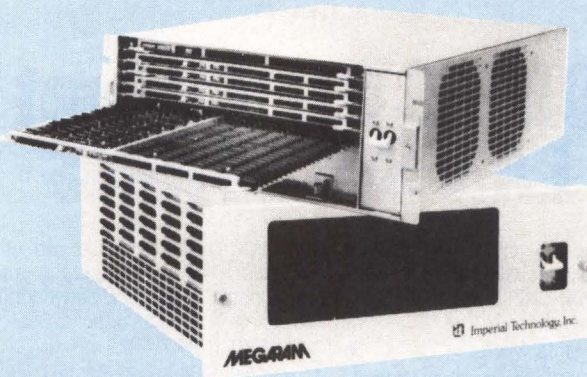

- Capacities from 2 megabytes to 40 megabytes in 2 megabyte increments.
- Up to 40 megabytes in a 7" chassis.
- Battery back-up.
- Streaming drive back-up in 7" chassis.

Advantages of The MegaRam Over Rotating Discs:

With no moving parts and easily replaceable sub-assemblies, the use of the solid-state MegaRam Disc Emulator assures dramatically increased performance and reliability. It further simplifies field maintenance.

Designed for use with the following computers:

- DEC • Data General • Sperry Univac (V77 Series)
- Hewlett Packard (HP1000 Series) • Modcomp
- SEL • CDC (System 17)

Replaces the Following Fixed Head Discs:

- DDC • Data Flux • Vermont Research
- Alpha Data

Typical Applications Include:

- Process Control • Mobile Equipment
- Telecommunications • Data Base Management
- Data Acquisition • Swapping Files • Automated Test Equipment • Graphics • Array Processors

Other configurations may also be available.
Please consult factory for information.



Imperial Technology, Inc.

831 S. Douglas Street • El Segundo,
California 90245 • Phone: (213) 536-0018

CIRCLE NO. 55 ON INQUIRY CARD

NEW PRODUCTS DATACOMM

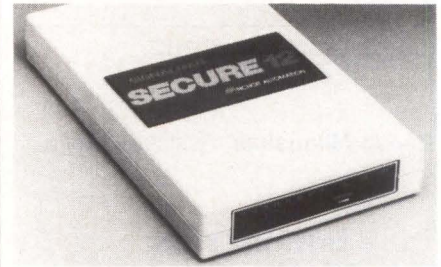

Modem includes security callback

- 1,200 bps
- Auto-dial, auto-answer
- Hayes compatible

An intelligent modem for personal computer applications requiring secure access from a remote location, the Signalman Secure 12 transmits data asynchronously at 1,200 bps. The auto-dial/auto-answer modem operates as a secure or a standard modem. Secure access is ensured by a password callback procedure. User-configurable security levels are password plus callback or password, callback and secondary password. The security callback system stores an average of 64 password and callback combinations, based on a seven-digit telephone number and an eight-character password stored in 1.2K bytes of dynamic memory. The modem conforms to the Hayes-compatible modem command structure and is compatible with the Bell 212A standard for operation with two-wire, full-duplex direct connect. \$499. **Anchor Automation Inc.**, 6913 Valjean Ave., Van Nuys, Calif. 91406, (818) 997-7758.

Circle 301

Backup unit restores network communications

- Multipoint line
- Bypass mode
- Self-test

The DBU 368 dial backup unit remotely restores communications in a data network by automatically bridging multipoint circuits and extending private lines beyond a failed hub site. Should a master modem fail or in the event that a multiplexed modem downspeeds and drops a multipoint tail circuit, the single-card unit restores an entire multipoint line, including the drops. It establishes dial connections using a speed-dialing feature that permanently stores up to 10 sets of



Actual unretouched photo

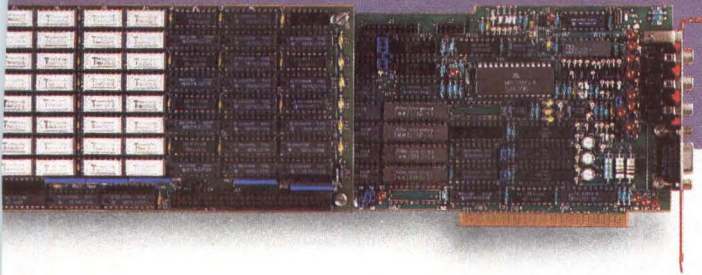

PC Imaging ... \$1995.00

- 512 x 512 x 8 frame buffer (PIP-512)
- 1024 x 1024 x 8 frame buffer (PIP-1024)
- 256 colors/gray shades
- 16.7 million color output lut
- Real-time 8-bit frame grab
- DMA image transfer — 1M pixels/sec.

Matrox now offers two new image processing boards, the PIP-512 and PIP-1024. The PIP series of boards provides complete 8-bit image acquisition, frame buffering, and display capability for the IBM PC. A PIP board upgrades the PC, XT or AT into a LOW COST, PROFESSIONAL image processing workstation.

The PIP boards have all the high performance features characteristic of top-of-the-line image processing systems, with one exception: price.

The PIP-512 sells for only \$1995.00 in single quantity.

For more info on MATROX PC imaging; CALL TOLL FREE 1-800-361-4903.



matrox

1055 St-Regis Blvd
Dorval, Québec, Canada
H9P 2T4
Tel.: (514) 685-2630
Tlx: 05-822798

22-digit numbers. Automatically bridging private-line signals with a dial-up connection, the unit reduces dial charges because the bridge can be located anywhere in the network to reduce dial distances. A bypass mode allows circuit extension over the dial-up network. Diagnostic features include self-test and soft straps. \$995. **Infinet Inc.**, 6 Shattuck

Road, Andover, Mass. 01810, (617) 681-0600.

Circle 302

Data switch suits 19.2K-bps devices

- Six to 192-line support

Ethernet TCP/IP for VAX/VMSTM Off the Shelf! Complete package for \$8,795

Excelan offers a complete high-performance communications package including hardware, software, transceiver and all cables. Everything you need to perform high speed file transfers or do remote logins via Ethernet from a VAX running VMS or UNIX System V to UNIX 4.2 BSD machines and vice versa. Software includes TCP/IP protocols, and standard FTP (file transfer) and Telnet (virtual terminal) applications.

The entire VAX/VMS package is only \$8,795, including the EXOS 204 Ethernet controller (quad-size Unibus board), EXOS 8040 TCP/IP software, EXOS 1100 transceiver and cables. And the entire UNIX System V package is only \$7,295.

Excelan also offers similar packages for DEC PDPs, UNIX supermicros, and the IBM PC, XT and AT.

EXCELAN

2180 Fortune Dr. San Jose, CA 95131
Phone (408) 434-2300 Telex 176610

UNIX is a trademark of AT&T Bell Laboratories.
Unibus, VAX, VMS, and PDP are trademarks of Digital Equipment Corporation.

CIRCLE NO. 57 ON INQUIRY CARD

- Rate conversion
- Port contention

Supporting from six to 192 lines, the Distributed Data Switch connects devices that send or receive data at rates up to 19.2K bps. The switch can be divided in two sections, each 1½ miles apart, connected via twisted-pair wires. Standard features include rate conversion; port connection by name, number or class; port contention; priority queuing; auto baud; password-controlled protection; help menu; and toggling, which allows users to connect two separate ports and alternate between them. A system control feature enables the switch to disconnect a port, monitor activity on another port or broadcast messages to any or all of a switch's ports. Each port has a configurable switch, attention sequence of one to three characters. \$800, basic unit; \$450, each card. **Sequel Data Communications Inc.**, P.O. Box 4069, Cary, N.C. 27511, (919) 469-9510.

Circle 303

Gateway, servers conform to TCP/IP protocols

- 14 asynch device support
- IBM SNA host connection
- Leased, dial-up lines

The GS/3-IP network gateway interconnects up to eight physically isolated transmission control protocol and internet protocol (TCP/IP)-based Ethernets over multiple point-to-point connection media, including leased or dial-up lines, fiber-optic and microwave links. Line speeds range from 1,200 to 64K bps. Data transfers between Ethernets run at 175K bps. The CS/1-SNA-TCP/IP server provides TCP/IP hosts access to the IBM SNA environment over Ethernet. It combines LAN connectivity and services with protocol conversion to IBM SNA hosts, allowing foreign terminals or PCs connected to proprietary servers to look like IBM 3278 terminals. The CS/100-TCP/IP is a terminal or host server that allows four, 10 or 14 asynchronous devices to access TCP/IP-based host computers and the CS/1-SNA-TCP/IP attached to an Ethernet. \$10,500, GS/3-IP, plus \$250 annual software fee; \$13,000, CS/1-SNA-TCP/IP, plus \$1,000 software fee; \$5,400, CS/100-TCP/IP, plus \$250 annual software fee. **Bridge Communications Inc.**, 1345 Shorebird Way, Mountain View, Calif. 94043, (415) 969-4400.

Circle 304

Introducing high performance switching at a low cost.



The IDX750™ Data PBX.

IDX750 is a trademark of M/A-COM, Inc.

© 1985 M/A-COM

M/A-COM's IDX750™ is, quite simply, the best data PBX on the market today. Through high capacity switching, your users can access computers, printers and other peripherals from any location in your network. The IDX750 is compact, powerful and can be upgraded to larger capacity IDX models as your network grows. Yet the IDX750 is remarkably low in cost—and includes more standard features than any other data PBX.

- **Expandable**- modular growth from 24 to 768 lines with no system downtime.
- **User-Friendly**- menu-driven software with extensive "help" and information commands.
- **Cost-Effective**- multiplexes 24 asynchronous lines onto two twisted pairs at distances up to one mile.
- **Non-Blocking Design**- all full-duplex connections can run at speeds up to 19.2 Kbps simultaneously.
- **Network Control**- system configuration, management and diagnostics easily performed.
- **Reliable**- automatic switchover to optional redundant components.

M/A-COM is a leader in the development and manufacture of state-of-the-art communications equipment, providing complete support services. If you would like more information on the IDX750, call toll free (800)626-6640 or (619)457-2340; or write M/A-COM Telecommunications Division, 3033 Science Park Road, San Diego, California 92121.

M/A-COM
Telecommunications Division

CIRCLE NO. 58 ON INQUIRY CARD

Introducing a start-up systems company that wasn't born yesterday.

We're Hamilton Standard Digital Systems, Inc. And although we may be a new name to you, we're not new to the systems business. In fact, Hamilton Standard has been a major supplier of systems products for nearly thirty years.

And now, we've taken over the Mostek Systems Technology you've come to trust from our sister UTC company. And in the process, created a start-up systems company with a head start in the business.

For example, we're the world's largest supplier of 8-bit, Z80®-based, CP/M®-compatible STD BUS boards. Like our newest intelligent STD BUS family including the 68010-based processor card, and our user-configurable intelligent I/O VMEbus products, we offer a range of more than 30 other STD and VMEbus boards that help you build flexible, high-performance systems.

We're also a major supplier of add-in products for DEC®, Data General, Perkin-Elmer and MultiBus systems. And a pioneer of surface mount technologies, which allow a reduction of 40-60% in board sizes. We offer full-service CAD and automated manufacturing facilities. And a custom-build-to-print service to produce your own design, or vary one of ours.

So whatever your systems needs, start up a conversation with your nearest Hamilton Standard Digital Systems representative. In the Northeast, call 203/531-1146 or 609/596-9200. In Central areas, 214/466-7921 or 312/577-9870. In the West, 714/250-0455 or 408/287-5080. Or write 1419 Dunn Drive, Carrollton, Texas 75011, 214/446-2664.



See us at Dexpo West Booth #282

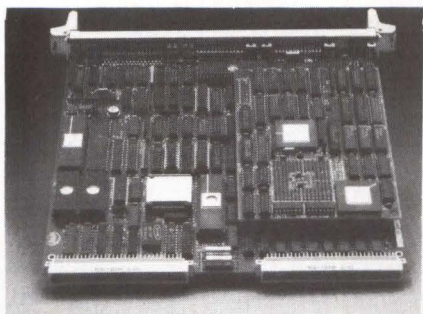

SBC controls multiple peripherals

- 80186 CPU
- Handles 12 drives
- 128K-byte RAM

The iSBC 186/224 single-board computer, a multiperipheral controller sub-system, supports up to four ST506/412-compatible, Winchester disk drives, up to four 5¼-inch, flexible disk drives (SA450/460-compatible) and up to four QIC-02 streaming-tape drives. The board, based on the 80186 microprocessor, includes diagnostics with built-in self-testing, the ability to configure software via interconnect space and the use of virtual interrupts. Performing multiple operations concurrently, the unit contains 128K bytes of dynamic RAM for multiple track-caching, boosting performance by supplying data to the CPU without incremental access to the Winchester disk. A driver for the iRMX 86 real-time operating system is available for the board. \$1,995. **Intel Corp.**, 5200 N.E. Elam Young Parkway Hillsboro, Ore. 97123, (503) 640-7147.

Circle 305

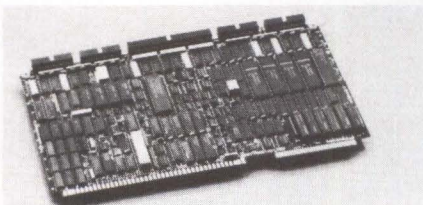

Controller supports four SMD disk drives

- iSBC 220-compatible
- Multibus-compatible
- Defective-track handling

A standard Multibus printed-circuit board, the MB-SMD contains a microprocessor, an interface and control logic to be software-compatible with the Intel

iSBC 220 disk controller. Installed directly into the Multibus computer or expansion chassis, the controller provides the interface for a disk system of up to four large-capacity, removable or fixed media SMD disk drives operating at a 2.4M-byte-per-second data transfer rate. A defective-track handling feature reformats the track, assigns it a defective-track code and enters the address of

the next alternate track. A self-test feature includes four LEDs to identify faults. Addressing capability is 16-, 20- or 24-bit selectable. Automatic error recovery and retry allow non-fatal errors to be recovered and/or retried up to 27 times. \$2,100. **Wespercorp**, 14511 New Myford Road, Tustin, Calif. 92680, (714) 730-6250.

Circle 306

RIP OFF THIS PRINTER.

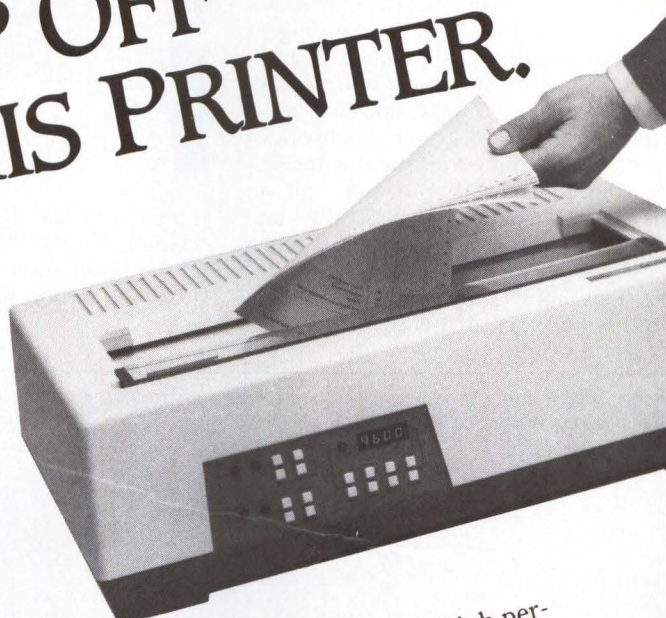

Stop wasting forms. Get the new Datasouth 180DD—the high performance printer for true-to-form printing. It's fast, it's rugged, it's sophisticated and it prints legibly through six-part forms with ½ inch tear-off capability.

This makes the DS 180DD the ideal printer for hotels, motels, airlines, travel agencies—for any job that requires quality multipart form printing on demand.

Call your nearest Datasouth distributor today and ask about the new DS 180DD. When you consider all the money-saving advantages, it's really quite a steal.

datasouth
HIGH PERFORMANCE MATRIX PRINTERS

CALL TOLL FREE:
1-800-222-4528
Ext. 592

Datasouth Computer Corporation
Box 240947 • Charlotte, NC 28224
704/523-8500 • Tlx 6843018 DASOU UW

CIRCLE NO. 60 ON INQUIRY CARD

Software facilitates information-system design

- IBM PC/AT-compatible
- 256K-byte requirement
- DeMarco methodology

Automating the paper-intensive design methods of system developers, Structured Architect develops information systems on personal computers. Using the DeMarco method employed in the development of information-processing systems, the software tool graphically represents data-flow diagrams and validates the analyst's model according to structured analysis and produces analysis documentation. It allows information-system managers to subdivide large projects by creating a distributed network of personal computer workstations for system developers. The program runs on the IBM PC, PC/XT, 3270 PC and PC/AT with 256K bytes of memory and a fixed disk as well as on Compaq Portable, Plus and DeskPro models. Graphics boards supported include Hercules,



Tecmar and the IBM Color Graphics Adapter. \$3,500. **ISDOS Inc.**, Suite 103, 325 E. Eisenhower Parkway, P.O. Box 4179, Ann Arbor, Mich. 48106-4179.

Circle 307

Software executes presentation graphics

- 200 symbols
- Automatic spacing
- Chart editing

Freelance software combines graphics-presentation capability with chart editing, word-chart creation, symbol libraries and freehand drawing. Existing charts produced with Lotus 1-2-3 or the proprietary Graphwriter can be customized with comments, arrows, company logos or specialized symbols as well as resized and combined with other charts, images or text. Over 200 pre-drawn symbols are standard, grouped into sets ranging from arrows and borders to demographic and architectural symbols. When creating diagrams, illustrations or freehand images, objects can be moved, rotated, sized and edited with the help of custom grids, rulers and templates. Running on the IBM PC, PC/XT or PC/AT, the program requires 256K bytes of memory. Support is provided for the IBM Color Graphics



Adapter, the IBM Enhanced Graphics Adapter and the Hercules graphics card. \$395. **Graphic Communications Inc.**, 200 Fifth Ave., Waltham, Mass. 02254, (617) 890-8778.

Circle 308

APL interpreter works with XENIX OS

- Concurrent file sharing
- Screen editing
- External process interface

The APL * PLUS UNX System is an enhanced APL interpreter and application-development system for the IBM PC/AT running under the XENIX operating system. The program's partial compilation of APL code results in no repeated syntactic analysis. Multiple function and variable full-screen editing allows simultaneous creating, viewing and editing of images. The system's concurrent file-sharing capability allows simultaneous updating of component files by different users. An external process interface facilitates a variety of non-APL

programs such as database managers and graphics packages. The system requires 1M byte of memory. \$995. **STSC Inc.**, a Contel company, 2115 E. Jefferson St., Rockville, Md. 20852, (301) 984-5000.

Circle 309

Software library aids image processing

- 80 modules
- LUT manipulation
- Line, area operations

A standalone library of board-level and image-processing routines for use with the proprietary PCVision Frame Grabber, ITEX/PC software speeds program development. The package contains over 80 routines that are callable from Microsoft Pascal, FORTRAN or C. Running on the IBM PC/XT, PC/AT and compatibles, the software reduces program memory requirements because only those routines used in the program are taken from the library after program linking. Included in the routines are initialization and register access, look-up

table manipulation, image acquire and clear, image save and restore, pixel read and write, line and area operations and image geometry, processing and graphics. \$1,595, single-use license. **Imaging Technology Inc.**, 600 W. Cummings Park, Woburn, Mass. 01801, (617) 938-8444.

Circle 310

ANSWER TO NOVEMBER'S PUZZLE

F	O	R	M	A	T		H	A	C	K	E	R	
I	M		A	D	A	R		S	L	A	V	E	
E	N		C	A	C	H	E		O	D	E	S	
L	I	E	R			O			N	I		E	
D		L	O	A	D		A	C	E		I	T	
	M	E		M	E	D	I	A		S	T		
M	I	C	R	O	D	O	M	P	U	T	E	R	
	C	T		L	A	S	E	R		A	M		
S	E		M	E	L		D	I	S	K		C	
L		Z	O			W			H	E	R	O	
U	S	E	D			M	E	R	G	E		O	B
M	I	R	E	S		B	A	S	E		D	O	
P	R	O	M	P	T		M	A	T	T	E	L	

DEC VT-220 compatibility, Wyse-style.

At \$799 our WY-85 gives you complete DEC VT-220™ software compatibility in function and fit, plus a form that beats all, for a price that beats all.

Like all our terminals, the WY-85 packs all the ergonomic features you want into an unusually small footprint. The generous 14" non-glare screen tilts, swivels, and handles a full 132-column format. Even the sculpted, low-profile keyboard adjusts for perfect fit and easier function.

So you get not just emulation, but the full operational compatibility you're looking for, including keyboard layout. For a lot less money, in a lot less space, with a lot more style.

No wonder Wyse terminals are now on more than 250,000 desktops worldwide.

For more information about our full line of computer display products, call toll-free, today.

WYSE
| | | |

Call 800-GET-WYSE

CIRCLE NO. 61 ON INQUIRY CARD

VT-220 is a trademark of Digital Equipment Corporation. The "V" shaped design is a trademark of Wyse Technology.

Now you can take supercomputing power to the ends of the Earth.



And beyond.

Introducing the first family of Micro Supercomputers.

Imagine supercomputing power you can take to the application. Today, MASSCOMP™ makes it a reality.

We've expanded the MC500 series to the MC5000 family by adding four new systems with faster 32-bit CPUs. Using our realtime version of the UNIX™ operating system (RTU™) and multiprocessing technology, they define a whole new class of computers. We call them micro supercomputers.

These new machines enable you to perform parallel data acquisition, computation, networking and graphics, without one task degrading another. They're designed to exploit concurrent operations while delivering powerful system performance in engineering, scientific and other computationally intensive applications.

MASSCOMP gets more performance at each level of technology than any other computer company. The ratio of whetstones or samples/second to the dollar proves it. No one else comes close.



They're in a class by themselves.

PRICE: \$15,000 – \$250,000

PERFORMANCE:

.7 to 10 MIPS
625K to over 12,000K Whetstones/
second
Up to 13 Mflops
1,000,000 samples/second—data
acquisition
1–4 CPU multiprocessors

RELIABILITY:

Less than 1 hardware failure per
year average

UNIQUE FEATURES:

Realtime UNIX™ operating system
68020 multiprocessing
Triple Bus™ architecture
Multiple graphics, networking options

Our micro supercomputers are transportable and dependable, whether you're studying the ocean floor through arctic ice or an oil field through desert sand. These are the kinds of places you can't take a computer that's going to break down. Relax. Our record of reliability sets the standard for the rest of the industry.

Choose from five systems you can tailor to your evolving needs. You'll realize the full advantage of the industry standard UNIX operating system coupled with our proprietary realtime enhancements. When you also consider the flexible applications software and powerful computational ability, it's easy to see why our micro supercomputers are in a class by themselves.

For more information, call us at 800-451-1824 or (617) 692-6200; or write MASSCOMP, One Technology Park, Westford, MA 01886.

You won't find a better system if you go to the ends of the Earth.

Or beyond.

 **MASSCOMP**
The Micro Supercomputer Company

800-451-1824

MASSCOMP, RTU and Triple Bus are trademarks of Massachusetts Computer Corporation. UNIX is a trademark of AT&T Bell Laboratories.

CIRCLE NO. 62 ON INQUIRY CARD

An
eye-opening
comparison
between
two
\$600 terminals.

TELEVIDEO 955

(Photo actual size)

PRODUCTS INC.

PERIOD: Q3, 1985

NUMBER	ITEM	SHIPDATE	WAREHOUSE	SHIPDEST	CARRIER	CUST.TOTAL
87654	200	10/02/85	NIPHILIDE	NEW YORK	ACNETRS	250.21
50987	007	12/01/85	CENTRALLA	BOSTON	AJAXAIR	150.77
90867	999	ONHOLD	WOODLAWN	CHICAGO	DUMAIR	100.32
99999	808	11/19/85	ATLANTANW	AUGUSTA	ELFRT	500.11
85748	922	12/07/85	MINNSTPAUL	MINNIAP	TRUCKER	12.51
54970	905	09/28/86	SANJOSESE	SANMATED	SHORTAIR	500.55
58759	894	11/08/85	SACRAMENTO	SANJOSE	EZHAULER	50.34
89220	955	12/18/87	IRVINECA	WESTLAWN	LATRUCK	500.12
57463	888	10/26/86	GRTFALLS	GRTFALLS	FALLSTR	750.04
58473	543	12/24/85	DALLASFW	AUSTIN	LONGSTAR	855.55
90795	666	04/01/86	NEWYORK	FARGO	TRUCKIN	905.55
05767	332	09/17/86	FLORIDAKEY	MELBORNE	SHIPWAY	888.31
58574	777	07/10/86	LASVEGAS	RENO	TRAIN	777.99
58764	923	12/15/85	PORTLAND	CORVALIS	T	
54746	345	12/17/86	GREENBAY	UPPERPEN	U	
05767	111	11/11/85	HAMBURG	FRNKFURT	D	
58607	456	04/27/86	CHICAGONW	HAKENSAK	M	
79585	666	05/09/86	LONDONSW	BRIGHTON	L	

As you can clearly see, at TeleVideo® we've found a better way to put 132 columns on a 14" screen. By redesigning the proportion of our characters and putting more space between them, we've given the TeleVideo 955 the most readable 132 column display available. And that's just the beginning. We've also given it the most complete set of features ever built into a mid-range terminal. Just turn to the last page of this ad, and you'll see what we mean.

 TeleVideo

Most
132 column
terminals are
designed
to crunch a lot
of numbers.

WYSE WY-50

(Photo actual size)

CAPS BLK

SALES ANALYSIS

LATEX SPECIALITY

SALES PERSON	ID NUMBER	TERRITORY	CUSTOMER	CUST. NUMBER	PART
ABBOTT	101000000	NEW YORK	APEXINC	33333888899	KL234
ABRAMSON	102277754	BOSTON	ZINCINC	33388990044	KL234
BACH	100000456	CHICAGO	AASEWER	98750372378	KL230
BENSON	109857363	ATLANTA	TUSINC	77493887549	KL239
CAGNEY	107584948	MINNIAP	XYZCORP	34857683999	KL239
DEWITT	100958498	SANFRAN	JAKINC	82746532363	KL235
ELLIOTT	100674637	SANJOSE	ACDCORP	40874573839	KL230
FINEGOLD	107563848	LOSANGEL	LYNINC	94837394873	KL238
GOODMAN	106574647	MONTANA	CONSINC	93848473848	KL238
HILLMAN	109458574	DALLASFW	TEXACAN	75893738567	KL235
JACKSON	103546455	NDAKOTA	EXFARM	85737395473	KL230
KINGSTON	104958363	JAMAICA	DARKRUM	85736384938	KL239
		NEVADA	CASINO	91274937348	KL239
		OREGON	TIMBINC	02784503748	KL239
		WISCONS	NEWMINE	84874638459	KL238
		GERMANY	RUHRINC	85743648474	KL234
		NEWJERSY	MAPLEINC	85904874949	KL235
		LONDON	JAXCORP	85905737383	KL231

As you can more or less see, a typical \$600 terminal manages to fit 132 columns on a 14" screen. By crunching them together a lot tighter than normal. Which can lead to eyestrain, headaches, and just plain mistakes. All of which tend to be on the expensive side.

The
TeleVideo 955
is designed
to actually
let you
read them.

Besides making the TeleVideo 955 a lot more readable, we gave it a whole list of features you won't find on any other 132 column terminal. Like 64 non-volatile programmable function keys. With 512 bytes of dynamically allocated variable memory. Your choice of green or amber screen. And ergonomics that, unlike Wyse's, meet the human factors standards recommended for adoption by the American National Standards Institute. And you get all this for only \$629.

Available options include WY-50/50+ compatibility, graphics add-in board, and up to three additional pages of screen memory.

To see exactly how we compare feature for feature with the Wyse WY-50/50+, just look at the chart on this page.

Of course, there's an easy way to see how much more the TeleVideo 955 gives you. Get your hands on one and check it out from top to

bottom. If you're a computer professional, MIS manager, or VAR, you've got until February 28, 1986 to order an evaluation unit for the special price of \$400, including shipping. (U.S. and Canada only.) One per company, please. Just call 800-227-6703 and ask for Department 46. (In California, 800-632-7979.)

TELEVIDEO 955 VS. WYSE WY-50 AND WY-50+			
FEATURES	TVI 955	WY-50	WY-50+
Keyswitches tested to	100 million strokes	10 million strokes	10 million strokes
Screen color	Green or amber	Green only	Amber only
High contrast dark screen	Yes	No	No
Programmable function keys	16/64	16/32	16/32
Dynamically allocated function key memory	512 Bytes	128 Bytes	128 Bytes
Maximum bytes per function key	Unlimited	4	4
Graphics upgrade	Yes	No	No
User ROM Slot	Yes	No	No
List Price	\$629	\$599	\$699

The high-performance TeleVideo 955. It's a real eye-opener.



 **TeleVideo**

TeleVideo Systems, Inc., 550 East Brokaw Road, San Jose, CA 95150-6602, (408) 971-0255
 REGIONAL OFFICES: WEST (408) 971-0255, SOUTHWEST (714) 476-0244, SOUTH CENTRAL (214) 258-6776,
 SOUTHEAST (404) 447-1231, MIDWEST (312) 397-5400, EAST (516) 496-4777, NORTHEAST (617) 890-3282,
 AMSTERDAM: 31.2503.35444, PARIS: 33.1.687.34.40, LONDON: 44.9905.6464.
 WYSE is a trademark of Wyse Technology. ©1985 TeleVideo Systems, Inc.

NEW PRODUCTS LITERATURE

Directory provides printer specifications

The 1986 *Printing Directory and Specification Guidebook Series* covers thermal, toner-based, color hard-copy and ink-jet printing in four volumes. Included are specifications of each printer, the manufacturer's actual product literature and print samples. A summary and overview section categorizes competitive products and groups them by selected specifications. \$250, each volume. **Gorham International Inc.**, P.O. Box 8, Gorham, Maine 04038, (207) 892-2216.

Circle 311

Guide aids real-time design

The eight-page brochure, "A guide to designing real-time in less time," offers advice in designing microprocessor-based systems using real-time, operating-system software. The guide includes a lexicon of real-time software terminology and provides a checklist of considerations such as program size, processor power and changing system requirements for selecting the appropriate software. Free of charge. **Hunter & Ready Inc.**, 445 Sherman Ave., P.O. Box 60803, Palo Alto, Calif. 94306, (415) 326-2950.

Circle 312

Survey presents word-processor specs

The 45-page, "Microcomputer Word Processors" survey gives specifications and pricing information on 107 word processors for microcomputers from 90 vendors. The directory begins with a reference, summary index that provides basic information on operating systems, supported hardware, memory requirements, program features, print features and price. The index is followed by descriptions of each product, arranged alphabetically by vendor. Each entry includes information on the product type, software and hardware environment, file-handling capabilities, printers supported, distribution channels and terms and support (price, license availability and protection information). \$29. **Data Decisions**, 20 Brace Road, Cherry Hill, N.J. 08034, (609) 429-7100.

Circle 313

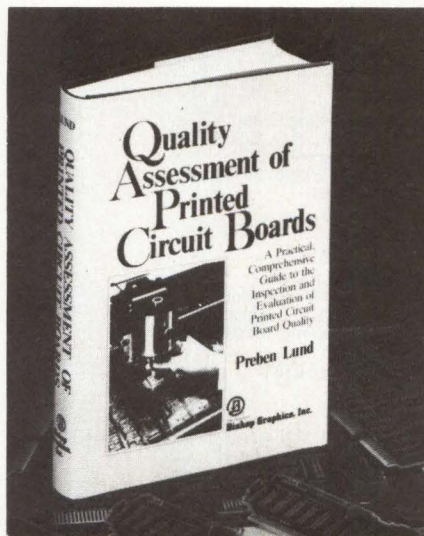

Volume assesses printed-circuit boards

Aiding printed-circuit board manufacturers, inspectors and designers, the illustrated and indexed *Quality Assessment of Printed Circuit Boards* provides information on establishing inspection criteria to identify board defects and their causes. Topics covered in the 530-page book include how to prepare for a cost-effective inspection, how to implement a sampling inspection method for reducing defects 90 percent to 95 percent, how to choose inspection equipment, how to evaluate inspection results and how to create and maintain an inspection record. The book contains 500 photos, graphs, tables and charts. \$59.95. **Bishop Graphics Inc.**, 5388 Sterling Center Drive, Westlake Village, Calif. 91359, (818) 991-2600.

Circle 314

Catalog lists board products

A 90-page, 1985-1986 Gespac catalog provides system integrators with descriptions of the company's board-level products, software packages and development systems. Product listings include processors, memories, interfaces, controllers, transducers and subsystems. A quantity-one-to-99 pricing supplement is provided. Free of charge. **Gespac Inc.**, 100 W. Hoover Ave., Mesa, Ariz. 85202, (602) 962-5559.

Circle 315

Report highlights AI applications

"Artificial Intelligence Applications for Business Management" is a 240-page report on the use of expert systems and natural-language software as a tool for business management. Applications include financial planning, decision support, marketing, text understanding, advisory services, language translation, editing and office automation. A chapter on using the personal computer is included. \$110. **SEAI Institute**, P.O. Box 590, Madison, Ga. 30650, (404) 342-9638.

Circle 316

Manual describes MC68020 CPU

The second edition of the *MC68020 32-bit Microprocessor User's Manual* aids design engineers, software architects and computer designers in the completion of hardware and software systems using the Motorola microprocessor. A definition of the CPU's instruction set is provided, as are complete timing diagrams and specifications. The manual's 11 chapters are Data Organization and Addressing Capabilities, Instruction Set Summary, Signal Description, Bus Operation, Processing States, On-Chip Cache Memory, Coprocessor Interface Description, Instruction Execution Timing, Ordering Information, Mechanical Data and Electrical Specifications. \$5.20. **Motorola Inc.**, Literature Distribution Center, Broadway Building No. 1, 616 W. 24th St., Tempe, Ariz. 85282, (602) 994-6561.

Circle 317

Catalog details datacomm devices

A 160-page book listing over 500 data-communications devices, the *Black Box Catalog* contains a 12-page, color insert highlighting 36 new products. It covers data switches, data cables, power managers, surge-protection devices, tools and networking hardware, test sets, multiplexers, modems, protocol converters, printer interfaces and reference books. Free of charge. **Black Box Corp.**, P.O. Box 12800, Pittsburgh, Pa. 15241, (412) 746-5500.

Circle 318

REGIONAL SALES OFFICES

BOSTON

Robert K. Singer
National Sales Manager
Norma E. Lindahl
Assistant To The National
Sales Manager

John J. Fahey
Regional Manager
Katie Kress
Sales Coordinator
275 Washington St.
Newton, MA 02158
(617) 964-3030

PHILADELPHIA

Stephen B. Donohue
Regional Manager
1873 Route 70, Suite 302
Cherry Hill, NJ 08003
(609) 751-0170

ATLANTA

Larry Pullman
Regional Manager
6540 Powers Ferry Rd.,
Suite 170
Atlanta, GA 30339
(404) 955-6500

CHICAGO

Robert D. Wentz
Regional Manager
Marianne Majerus
Sales Coordinator
Cahners Plaza
1350 E. Touhy Ave.
P.O. Box 5080
Des Plaines, IL 60018
(312) 635-8800

DALLAS

Don Ward, Regional Manager
13740 Midway Suite 515
Dallas, TX 75234
(214) 980-0318

DENVER

John Huff
Regional Manager
270 St. Paul St.
Denver, CO 80206
(303) 388-4511

LOS ANGELES

Len Ganz
Regional Manager
12233 West Olympic Blvd.
Suite 236
Los Angeles, CA 90064
(213) 826-5818

ORANGE COUNTY

Debra Huisken
Regional Manager
2041 Business Center Dr.
Suite 109
Irvine, CA 92715
(714) 851-9422

SAN FRANCISCO

Frank Barbagallo
Northwestern Region Sales Manager
Rick Jamison
Regional Manager
Kathleen Maxwell
Sales Coordinator
Sherman Building, Suite 100
3031 Tisch Way
San Jose, CA 95128
(408) 243-8838

AUSTRIA

Elan Marketing Group
Neutor g. 2
P.O. Box 84
1013 Vienna, Austria
Tel: 43-222-663012 or -638461

BENELUX

Elan Marketing Group
Boschdijk 199B
5612 HB Eindhoven
The Netherlands
Tel: 31-40-455724

ISRAEL

Elan Marketing Group
13 Haifa St., P.O. Box 33439
Tel Aviv, Israel
Tel: 972-3-252967 or -268020
Telex: 341667

JAPAN

Kaoru Hara
General Manager
Trade Media Japan Inc.
Suite 412 Azabu Heights
1-5-10 Roppongi Minato-ku,
106, Japan
Tel: (03) 587-0581

TAIWAN

Mr. Donald H. Shapiro
Trade Winds, 2nd Floor
132 Hsin Yi Road, Sec. 2
Taipei, Taiwan

UNITED KINGDOM

Elan Marketing Group
5th Floor, Suite 10
Chesham House
136 Regent St.
London W1R 5FA
Tel: 437-6900
Telex: 267653

SWEDEN

Elan Marketing Group
Humlegardsgatan Nr. 5
11446 Stockholm, Sweden
Tel: 46-8-677243 or -676243

Mini-Micro Marketplace

Norma Lindahl
275 Washington St.
Newton, MA 02158
(617) 964-3030

Direct-Response Postcards

Carol Flanagan
275 Washington St.
Newton, MA 02158
(617) 964-3030

Career Opportunities

Norma Lindahl
Recruitment Advertising Manager
275 Washington St.
Newton, MA 02158
(617) 964-3030

Cahners Magazine Division

William Platt, President
T.M. McDermott, Vice President
Electronics/Computer Group
Tom Dellamaria, VP/Production
Ira Siegel, VP/Research

Promotion Staff

Susan Rapaport
Marketing Communications Director
Mary Gregory
Promotion Manager
Elizabeth Phillips
Marketing Assistant

Circulation

Denver, CO:
(303) 388-4511
Sherri Gronli
Group Manager

NEW PRODUCTS LITERATURE

Report emphasizes LAN strategies

In Section I of the 320-page, "Local Network Vendors' Strategies Report," 20 LAN companies are considered in terms of the fundamental technology and topological structure they employ, their level of correspondence to the OSI reference model and their marketing strategies. The section examines the stability of the various vendors and their ability to sustain a product line. Section II offers a closer look at individual products from key LAN vendors such as Nestar, Novell, Sytek and Ungermann-Bass. Special attention is paid to the LAN direction of IBM and AT&T. Descriptions of the hardware and software available include technical data, diagrams and pricing information. The report also includes three reference tables highlighting broadband, baseband and PBX system vendors and their addresses. \$219. **Architecture Technology Corp.**, P.O. Box 24344, Minneapolis, Minn. 55424, (612) 935-2035.

Circle 319

Book examines PC technology

The 369-page *Insights Into Personal Computers* is coauthored by leading personal computer industry representatives who describe their companies' personal computer architectures, software and applications. The book discusses products in terms of general makeup, characteristics, hardware, software, industry, networks and history. Chapters include material on the anatomy of a portable computer, the role of communication technologies in the personal computer revolution, the function of venture capital in the industry and computer graphics. Personal computer architectures from the following companies are detailed: Apple, Data General, DEC, Hewlett-Packard, IBM, NEC, Texas Instruments and Wang, along with Intel's 80286 microprocessor. \$29.50. **The Institute of Electrical and Electronics Engineers Service Center**, 445 Hoes Lane, Piscataway, N.J. 08854.

Circle 320



TO YOUR IBM® SOFTWARE, IT'S JUST ANOTHER DAY AT THE OFFICE.

The Sharp PC-7000 makes transporting your work easy. It folds into a case small enough to fit



The Sharp PC-7000.

under an airplane seat, takes up less desk space than this magazine (opened, of course) and weighs less than 19 pounds.

IBM is a registered trademark of International Business Machines Corporation. MS-DOS is a trademark of MicroSoft Corporation.

But don't carry it just because it's easy to carry.

Carry it for MS-DOS 2.11, and built-in dual floppy disk drives that provide the IBM® standard 360KB format. The 320KB RAM is ample memory for even large spreadsheet or data-base applications.

Or carry it because it's easy to use. In addition to a high-speed 16 bit microprocessor, the PC-7000 has an easy-to-read bit-mapped screen with backlighting from an innovative electro-luminescent panel. And the keyboard is detachable, ergonomically designed for comfortable use.

It only takes memory chips to

upgrade RAM, and a modem card enables it to communicate with other computers. And our Near-Letter-Quality (32 x 48 dots) silent transfer printer attaches directly to the main unit.

But best of all, carry it because it'll sell. Fast.

To find out more, call 1-800-BE-SHARP.

Computers and Peripherals, Audio, A/V Equipment, Banking Systems, Broadcast Cameras, Calculators, Cash Registers, Copiers, Electronic Components, Electronic Typewriters, Facsimile, Medical Products, Microwave Ovens, Televisions, Vacuum Cleaners, Video Recorders.
© 1985 Sharp Electronics Corp. 10 Sharp Plaza, Paramus, NJ 07652



**FROM SHARP MINDS
COME SHARP PRODUCTS**

CIRCLE NO. 63 ON INQUIRY CARD

This bus won't make you wait.

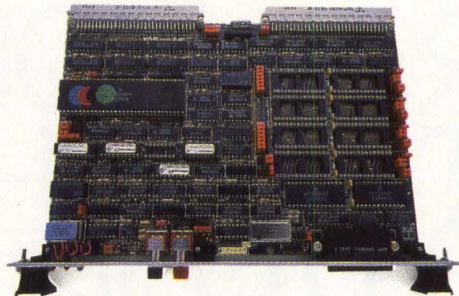
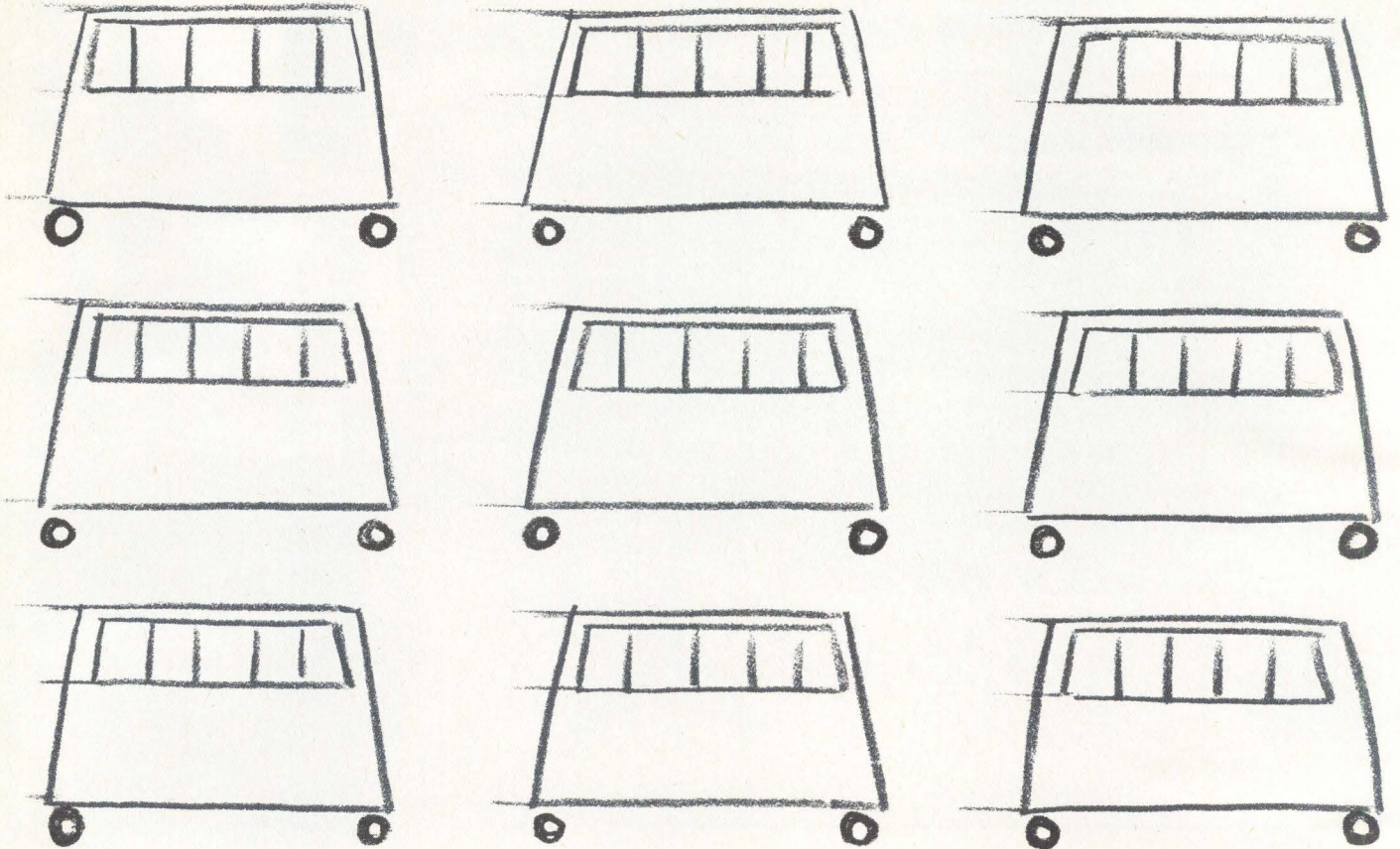

The Motorola VMEbus Microprocessor Modules from Hall-Mark.

You won't fall behind schedule with Motorola's line of VME Microprocessor Modules from Hall-Mark Electronics.

The MVME line is a family of versatile, VMEbus-compatible board-level computers that offer the performance required for data processing, data management and industrial control. Applications for these products range from high-speed single processor systems through systems of complex multi-

processor architecture.

- M68000-based
- Open architecture
- No fees
- Flexible
- 1000+ compatible products
- In stock now

Hall-Mark won't make you wait, either, with 32 stocking locations nationwide and a real-time, on-line computer system. So don't wait. Call Hall-Mark today.



Alabama
Huntsville (205) 837-8700

Arizona
Phoenix (602) 437-1200

California
Bay Area (408) 946-0000
Orange County (714) 669-4700
Sacramento (916) 722-8600
San Diego (619) 268-1200
San Francisco Valley (818) 716-7300
West Los Angeles (213) 217-8400

Colorado
Denver (303) 790-6662

Connecticut
Connecticut (203) 269-0100

Florida
Ft. Lauderdale (305) 971-9280

Georgia
Atlanta (404) 447-8000

Illinois
Chicago (312) 860-3800

Indiana
Indianapolis (317) 872-8875

Kansas
Kansas City (913) 888-4747

Maryland
Baltimore (301) 988-9800

Massachusetts
Boston (617) 935-9777

Minnesota
Minneapolis (612) 854-3223

Missouri
St. Louis (314) 291-5350

New Jersey
Fairfield (201) 575-4415

New York
Long Island (516) 737-0600

North Carolina
Raleigh (919) 872-0712

Ohio
Cleveland (216) 349-4632

Oklahoma
Southem Ohio (614) 888-3313

Oklahoma
Tulsa (918) 665-3200

Pennsylvania
Philadelphia (215) 355-7300

Texas
Austin (512) 258-8848

Texas
Dallas (214) 553-4300

Texas
Houston (713) 781-6100

Utah
Salt Lake City (801) 268-3779

Wisconsin
Milwaukee (414) 797-7844

HALL-MARK

Hall-Mark Electronics Corp. • Dallas, Texas • Subsidiary of Tyler Corp.

© 1985 Hall-Mark Electronics Corp. 02/35 1007

ARTFUL INTELLIGENCE

By John K. Young

ACROSS

- 1 Special function
- 3 One's own welfare
- 7 Interpret
- 11 Function
- 12 Internal structure
- 13 Affectionate abbreviate for state in SE U.S.
- 14 Smaller "half" of Bible (Abb.)
- 15 Entry channel
- 16 See in business capacity
- 17 First marketed robot
- 18 French "the"
- 19 Historical time period
- 20 Alternating current (Abb.)
- 22 I/O device
- 25 Your "handle"
- 27 Avoid
- 28 Follow copy (Abb.)
- 30 Monitor (Abb.)
- 31 Systems of symbols
- 33 Spanish for "river"
- 34 His full name means "fortunate"
- 35 Author of poker program for Apple II
- 36 France's leading domestic computer maker
- 37 High-speed memory location
- 40 City's overhead railway

- 41 Function
- 43 For example
- 44 Metal-headed golf club
- 45 Type of printer
- 47 Metal bonded layer
- 48 What one gets paid for working Sunday (Abb.)
- 49 Computer owner
- 50 Binary data
- 51 Type of exploded chart
- 52 French "beast"
- 53 Radix in numbers scale
- 54 Logical operation

DOWN

- 1 ___ matrix printer
- 2 Native to
- 3 Remember information
- 4 Mistake
- 5 Statement
- 6 Iron (Chem.)
- 7 Run batted in (Abb.)
- 8 Software language ties PCs to mainframes
- 9 Moslem ruler
- 10 Computer information
- 11 To improve
- 15 His full name means "rock"
- 16 DEC's model 8600 computer system
- 18 Type of printer
- 21 Printed-circuit board
- 23 Operating system
- 24 Hebrew eleventh month
- 26 Mount (Abb.)
- 28 Collection of related records
- 29 Gather together
- 31 Basketball player
- 32 Beginning (Abb.)
- 33 Ruthenium (Chem.)
- 35 Civil Engineer (Abb.)
- 36 Author of *Technostress: the Human Cost of the Computer Revolution*
- 37 Switch to release printer
- 38 Inclines produced by optical printer
- 39 Clear
- 41 Bungle
- 42 Level to the ground
- 46 Before
- 47 U.S. intelligence agency
- 48 CP/M command gives list of disk files
- 50 Air rifle pellet
- 51 River in N Italy

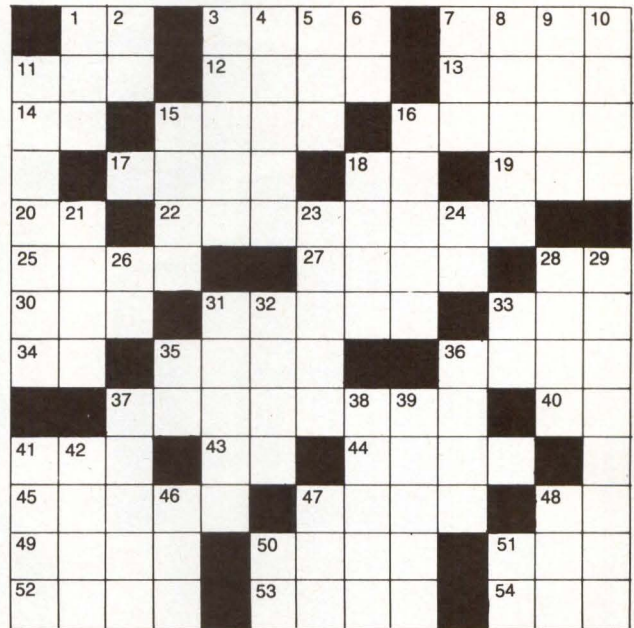

Solution will be printed next month.

Answers to November's puzzle can be found on Page 125.

Interest Quotient
(Circle One)
High 498 Medium 499
Low 500

516 MEGABYTE CAPACITY AND HIGH-PERFORMANCE IN A HALF-RACK DRIVE.

OVER
50,000
FSD UNITS
SHIPPED

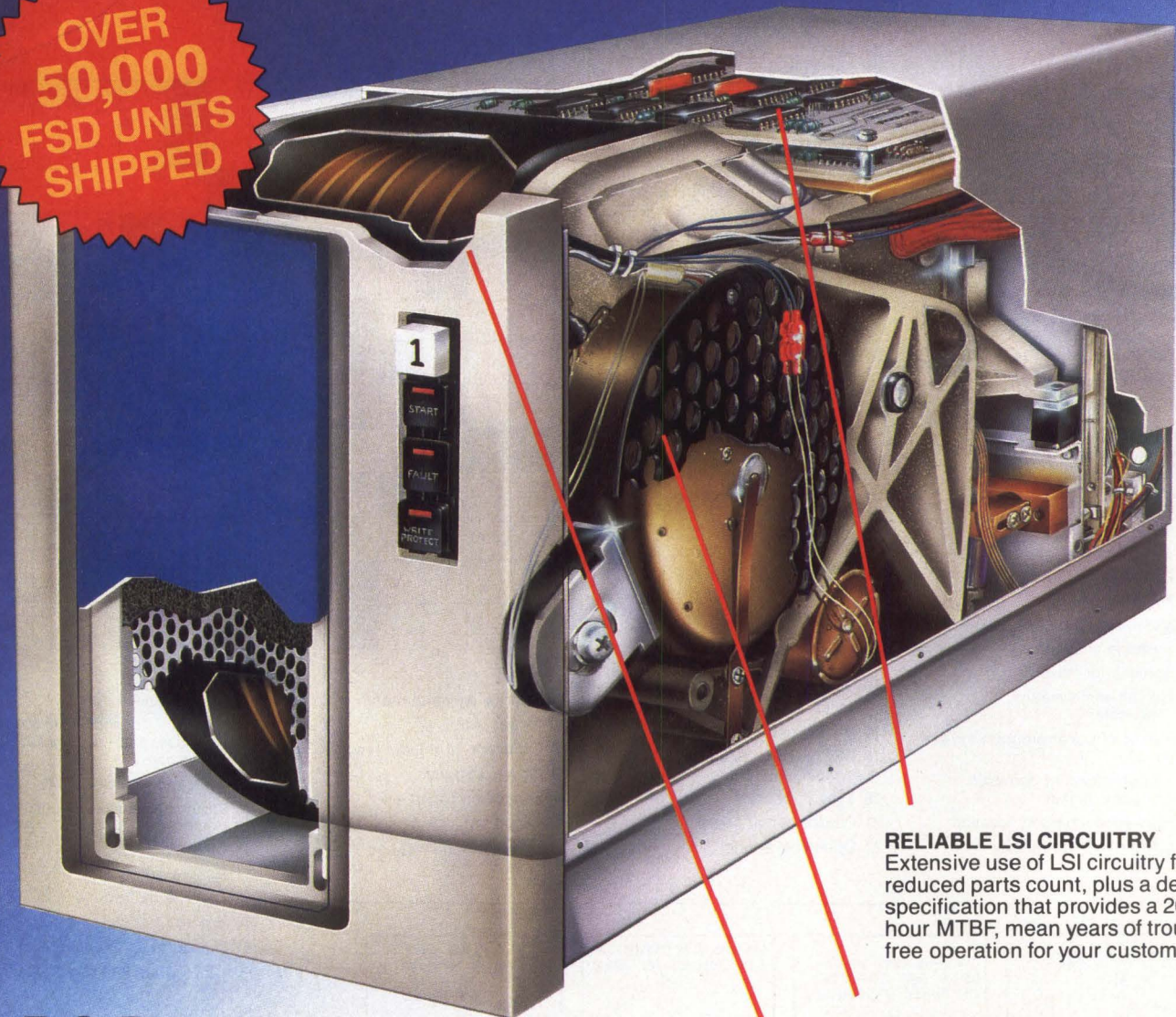

FSD

The FSD is the high-performance drive with built-in quality to match. After all, it's built in the U.S.A. by Control Data, leading supplier of OEM storage peripherals for over twenty-five years. And it's backed by our world-wide support system.

The FSD meets all FCC, UL, CSA, and VDE standards and features a dual channel option, daisy chain interface capability, phased-lock data separation, and much more. The FSD is ideally suited for your systems application.

Why not evaluate the FSD yourself? To qualify for an evaluation unit, or for more detailed information, call your local Control Data OEM sales representative direct, or our toll-free HOTLINE: 1-800/828-8001 EXT. 82. Or, write: Control Data, OEM Product Sales HQW08X, P.O. Box 0, Minneapolis, MN 55440.

RELIABLE LSI CIRCUITRY

Extensive use of LSI circuitry for a reduced parts count, plus a design specification that provides a 20,000 hour MTBF, mean years of trouble-free operation for your customer.

CHOOSE HIGH-PERFORMANCE OR ULTRA-HIGH PERFORMANCE

FSD operates with the standard SMD interface or the new SMD-E extended interface with a 14.5 MHz transfer rate, and an 18 millisecond data access rate for increased system throughput.

NEED EVEN MORE CAPACITY?

FSD's half-rack form factor permits installation of two drives in a standard 19" rack-mount configuration, giving you storage capacity of over one gigabyte.

 CONTROL DATA

CIRCLE NO. 65 ON INQUIRY CARD

CAREER OPPORTUNITIES/ RECRUITMENT ADVERTISING

Mini-Micro Systems
*delivers an audience of
qualified computer
professionals with titles
like these:*

- Software Engineer
- System Designer
- Project Engineer
- Systems Application Engineer
- Technical Staff Members
- MIS Director
- Network Planner
- Communication Manager
- Data Processing Manager
- Systems/Programming Specialist
- Instructors of Computer Technology
- Marketing Director
- Director of R&D
- Systems Engineering

Located within industries
like:

- Manufacturing
- Government
- R&D
- Education
- Computer Services
- Data Processing Services
- Utilities
- Finance
- Trade

For more information contact:
Carol Flanagan
Recruitment/Career Opportunities
275 Washington Street
Newton, MA 02158
617-964-3030 ext.413

EMPLOYMENT SERVICE FOR PROGRAMMERS AND ANALYSTS

National Openings With Client Companies
and Through Affiliated Agencies

Scientific and commercial applications • Software development and systems programming • Telecommunications • Control systems • Computer engineering • Computer marketing and support

Call or send resume or rough notes of objectives, salary, location restrictions, education and experience (including computers, models, operating systems and languages) to either one of our locations. Our client companies pay all of our fees. We guide; you decide.

RSVP SERVICES, Dept. MM
Suite 700, One Cherry Hill Mall
Cherry Hill, New Jersey 08002
(609) 667-4488

RSVP SERVICES, Dept. MM
Suite 201, Dublin Hall
1777 Walton Rd., Blue Bell, PA 19422
(215) 629-0595

From outside New Jersey, call toll-free 800-222-0153

RSVP SERVICES

Employment Agents for Computer Professionals

CIRCLE NO. 240 ON INQUIRY CARD

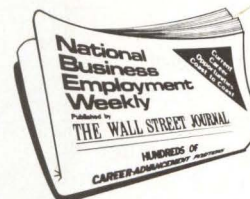

**Which one of our
computer-related
positions is right
for you?**

Find out in the
National Business Employment Weekly.

Every week, the National Business Employment Weekly, published by The Wall Street Journal, contains hundreds of the best executive, managerial and professional positions from all across the country. Top jobs in every field, including career opportunities in virtually every area of computer technology. At salaries from \$25,000 to \$250,000.

PLUS...weekly editorial features covering every aspect of career advancement. Articles on writing resumes, interviewing, salary statistics, regional employment trends, and much more.

LOOK FOR OUR SPECIAL OCTOBER 27TH
"EDP & COMPUTER ENGINEERING" ISSUE
WHICH WILL INCLUDE ADDITIONAL CAREER
OPPORTUNITIES IN THE COMPUTER INDUSTRY
AND RELATED EDITORIAL.

Pick up a copy of the National Business Employment Weekly at your newsstand today. Or we'll send you the next eight issues by first class mail. Just send a check for \$32 to:

National Business Employment Weekly,
Dept. MM, 420 Lexington Avenue,
New York, NY 10170.

CIRCLE NO. 241 ON INQUIRY CARD

When it comes to VAX™ 8600 memory, EMC doesn't play hard to get.

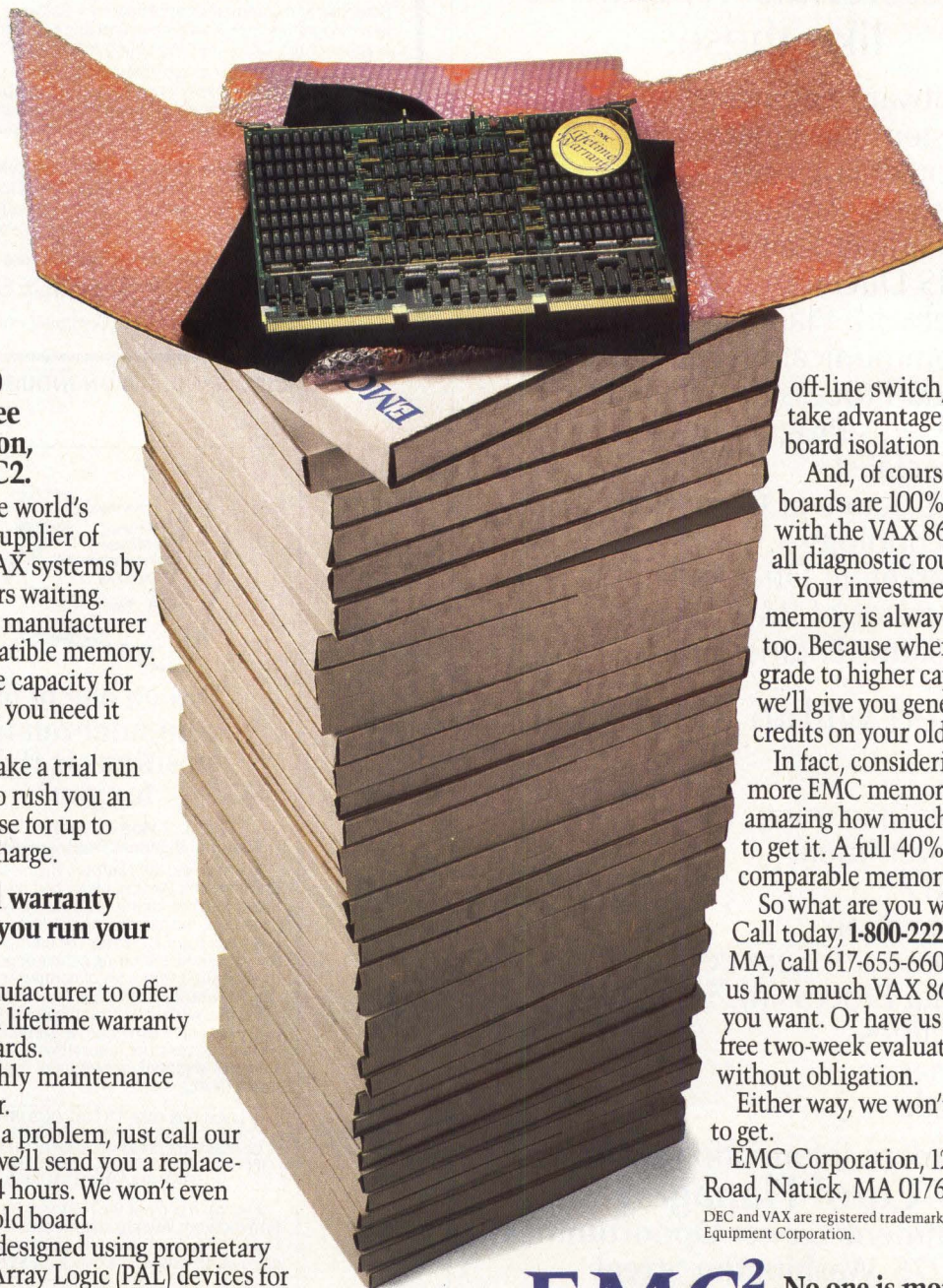

To order your 8600 memory or for a free two-week evaluation, call 1-800-222-EMC2.

We didn't get to be the world's largest independent supplier of add-in memory for VAX systems by keeping our customers waiting.

And we're the only manufacturer to deliver 8600-compatible memory.

So if you need more capacity for your VAX 8600—and you need it now—give us a call.

Or if you'd rather take a trial run first, we'll be happy to rush you an evaluation board to use for up to two weeks—free of charge.

Our unconditional warranty runs for as long as you run your VAX system.

EMC is the only manufacturer to offer you an unconditional lifetime warranty on all its memory boards.

There are no monthly maintenance charges, either. Never.

If you even suspect a problem, just call our toll-free hotline and we'll send you a replacement board within 24 hours. We won't even wait till we get your old board.

EMC's memory is designed using proprietary ECL Programmable Array Logic (PAL) devices for greater reliability. It comes with a built-in on-line/

off-line switch, so you can take advantage of the 8600's board isolation capabilities.

And, of course, all our boards are 100% compatible with the VAX 8600, including all diagnostic routines.

Your investment in EMC memory is always protected, too. Because whenever you upgrade to higher capacity boards, we'll give you generous trade-up credits on your old boards.

In fact, considering how much more EMC memory gives you, it's amazing how much less it costs to get it. A full 40% less than comparable memory from DEC.™

So what are you waiting for? Call today, 1-800-222-EMC2 (in MA, call 617-655-6600). And tell us how much VAX 8600 memory you want. Or have us send you a free two-week evaluation board without obligation.

Either way, we won't play hard to get.

EMC Corporation, 12 Mercer Road, Natick, MA 01760.

DEC and VAX are registered trademarks of Digital Equipment Corporation.

EMC² No one is more committed to memory.

See us at the DEXPO Show, Booth number 478.

CLASSIFIED ADS

inventions wanted

**INVENTIONS, IDEAS,
NEW PRODUCTS WANTED!**
Presentation to industry.
National Exposition.
Call: 1-800-528-6050, X831
ISC-MMS, 903 Liberty,
Pittsburgh, PA 15222

CIRCLE NO. 230 ON INQUIRY CARD

software

D-M-DRIVER
Disk in Memory.
for Micro/RSX, 11M(+) & P/OS
Call 415-420-9579
Proto Systems
1238 Josephine St. Berkeley, CA
*TM of Digital Equip Corp 94703

CIRCLE NO. 231 ON INQUIRY CARD

**This Publication
is available in Microform.**

University Microfilms International

Please send additional information

for _____ (name of publication)

Name _____

Institution _____

Street _____

City _____

State _____ Zip _____

300 North Zeeb Road, Dept. P.R., Ann Arbor, Mi. 48106

Copy Deadline: Call (617) 964-3030

Space reservations and advertising copy must be received by the 10th of the month preceding the issue date. Camera-ready mechanicals must be received by the

15th of the month preceding the issue date. For example, to appear in the February issue, copy must be received by January 10; mechanicals by January 15.

CLASSIFIED ADVERTISING ORDER FORM

Mini-Micro Systems classifieds reach more mini-micro people

**Rates: \$90.00 per column inch (non-commissionable)
6x program earns 5% discount; 12x program earns 10% discount.**

There is no charge for typesetting classified listings. Plan approximately 50 average words to a column inch, 8 lines of approximately 38 characters per line (3 inch maximum). Please send clean typewritten (double-spaced) copy.

Category: The following categories are available; be sure to specify the category you wish to be listed under: Business Opportunities, New Literature, Selling, Buying, Trading, Seminars, Services, Software, Supplies & Accessories. (Other categories may be employed at our discretion.)

Run this ad in _____ (number issues) Reader Inquiry No. YES NO
Ad size 1 col. wide by _____ inches deep Under _____ (category)
Check enclosed for \$ _____ (Pre-paid orders only)

Signature _____

Name _____ Title _____

Company _____ Telephone No. _____

Address _____

City _____ State _____ Zip _____

**MAIL TO: Linda L. Lovett, Classified Advertising, Mini-Micro Systems,
275 Washington St., Newton, MA 02158**

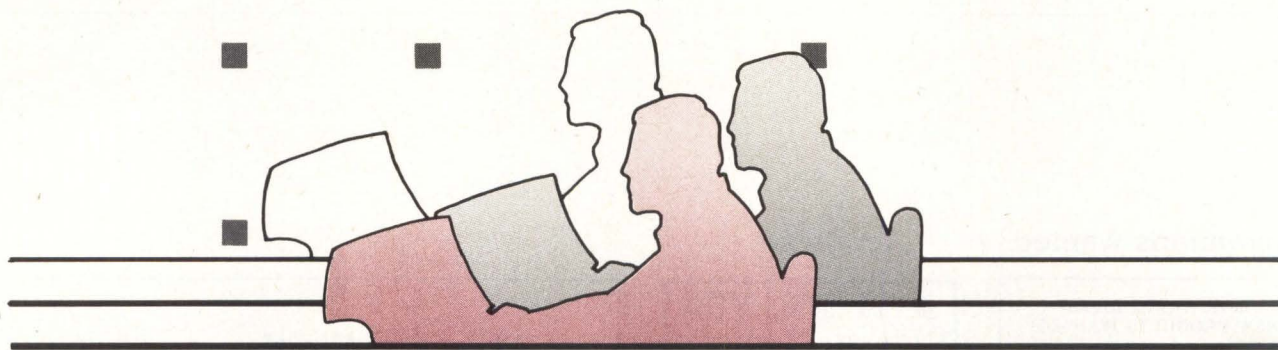

“Want More From Your Computer? UNIX* Gives You Options”

Networking...Multi-User...Multi-Functional...Multi-Tasking...Versatility...
High Resolution Graphics...Software Portability...Integrated Office Automation Software...Distributed Processing...Expandability.

These are just some of the highlights of UNIX that will be a part of UniForum 1986, February 4-7, Anaheim Convention Center. For a complete, hands-on UNIX experience you can take home and use, UniForum will feature:

- Over 200 major vendors exhibiting their newest UNIX-based hardware, software, systems, services and peripherals.

- FREE UNIX Introductory Workshops. These sessions provide valuable information on the basics of UNIX...its potential...and how it can expand and improve your computer system.

*UNIX is a trademark of AT&T Bell Laboratories.

Sponsored by



usr/group

The International Network of UNIX Users

- A complete tutorial and conference program. Multiple sessions target the connectivity of UNIX; hardware and software technology for office systems and workstations; the interface between man and machine, machine and machine, and much more.

Call us NOW...for your FREE Show-Only Badge...and complete registration information on the dynamic conference/tutorial program.

Whether you are brand new to UNIX, or a seasoned professional, UniForum 1986 is THE computer event you can't afford to miss!



UniForum™

The International Conference of UNIX Users

February 4-7, 1986
Anaheim Convention Center
Anaheim, California

For Complete Information, Call:

800-323-5155

(In Illinois, Call: 312-299-3131)

Or Write:

UniForum 2400 East Devon Avenue
Suite 205 Des Plaines, IL 60018

CIRCLE NO. 67 ON INQUIRY CARD

ADVERTISERS INDEX

Advanced Digital Corp.	C3	Macom	121
Alsyst	110	Masscomp	126
Ampro	114	Matrox Electronic Systems Ltd.	119
BASF	E-10-E11	Maxtor Corp.	109
Bull	E2, E5	Micom/Interlan	48-49
Century Data Systems (a Xerox Co.)	66	Microdesign International	9
CIE Systems	20	Microware	72
Communications Machinery Corp.	28	Motorola Semiconductor Products	13
Compaq Computer Corp.	35, 37, 39, 41, 43, 45-47	Multi-Tech	116
Control Data Corp.	138	NCR Corp.	24-25, 78
Datapoint	52	NCR Technology	81-83
Dataram	D3	Olivetti	E8
Datasouth Computer Corp.	123	Oracle	E1
Digital Equipment Corp.	D4-D5	Oregon Software	99
Digital Research	80	Panasonic	77
DSD Corp.	D1	Philips T&M	E12
Electronic Solutions	C2	Polygon	62
Emerson Electric	93	Quadram Corp.	71
EMC	140	Quantum	26-27
Emulex Corp.	5, 146	Qume	12
Equinox Systems	33	RDS-Relational Database Systems	60
Excelan	120	Rodime	10
Facit	16	Santa Cruz Operations	59
Fujitsu America Inc. Storage Division	22-23	Sharp IED	135
Gateway Communications Inc.	55	Siemens Corp.	E6-E7
Gould Inc., Computer Systems Div.	115	Software AG	1
Hall-Mark Electronics	106, 136	Sord Computer	61
Hamilton Standard	122	TEAC Corp.	8
Hayes Microcomputer Products	84	TeleVideo Terminals	103-105, 127-132
Hewlett-Packard Co.	6-7	Texas Instruments Inc.	56, 94
Hitachi America Ltd.	50-51	TransNet Corp.	92
Hi-Tech Training	D8	Uniforum	142
Houston Instrument Div. of Bausch & Lomb	100	Universal Data Systems Inc.	C4
Human Design Systems Inc. (HDS)	D7	Western Digital	14-15
Ibex Computers Corp.	114	Writing Consultants	4
IDE Associates	88	Wyse Technology	124-125
Imperial Technology Inc.	118		
Intercontinental Micro	117		
Interphase Corp.	64-65	See P. 141 for Classified Advertisers	
Keytronics	63	See P. 139 for Career Opportunity Advertisers	
Kimtron	113	See P. 147-148 for Mini-Micro Marketplace	
Lexidata Corp.	87		
Macrolink	19		

This index is provided as an additional service. The publisher does not assume any liability for errors or omissions.

This Publication is available in Microform.

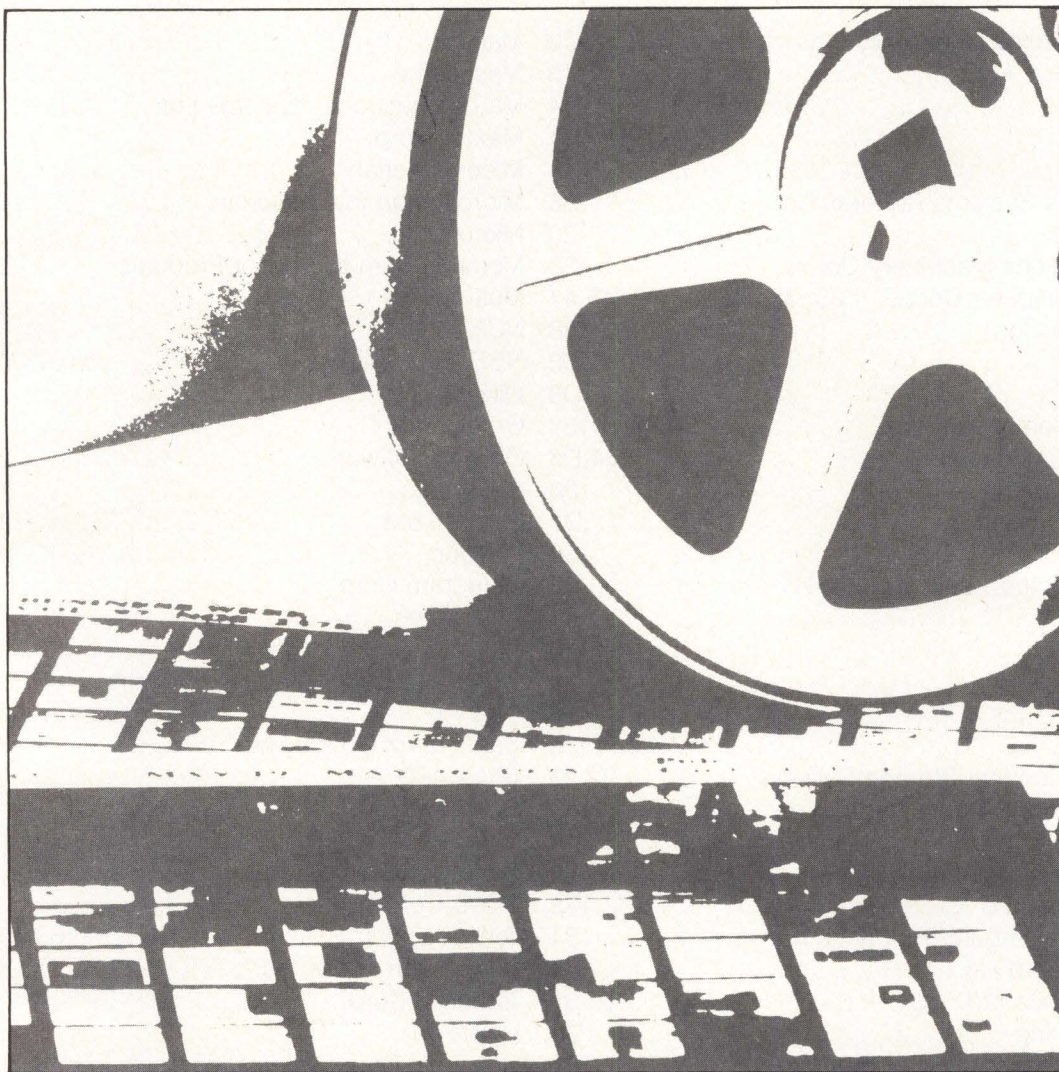

Please send additional information for _____
(name of publication)

Name _____

Institution _____

Street _____

City _____

State _____ Zip _____

**University
Microfilms
International**

300 North Zeeb Road, Dept. P.R., Ann Arbor, Mi. 48106

T H E 1 9 8 5

TRADESHOW WEEK DATA BOOK

The Total Information Tool for Tradeshow Professionals

- STATISTICS & PERFORMANCE RECORDS ON U.S. TRADESHOWS
- SHOWS ARRANGED BY INDUSTRY CLASSIFICATION
- ALPHABETICAL SHOW INDEX
- GEOGRAPHICAL SHOW INDEX
- CHRONOLOGICAL SHOW INDEX
- TRADESHOW ASSOCIATION INDEX
- MULTIPLE SHOW MANAGEMENT COMPANY INDEX

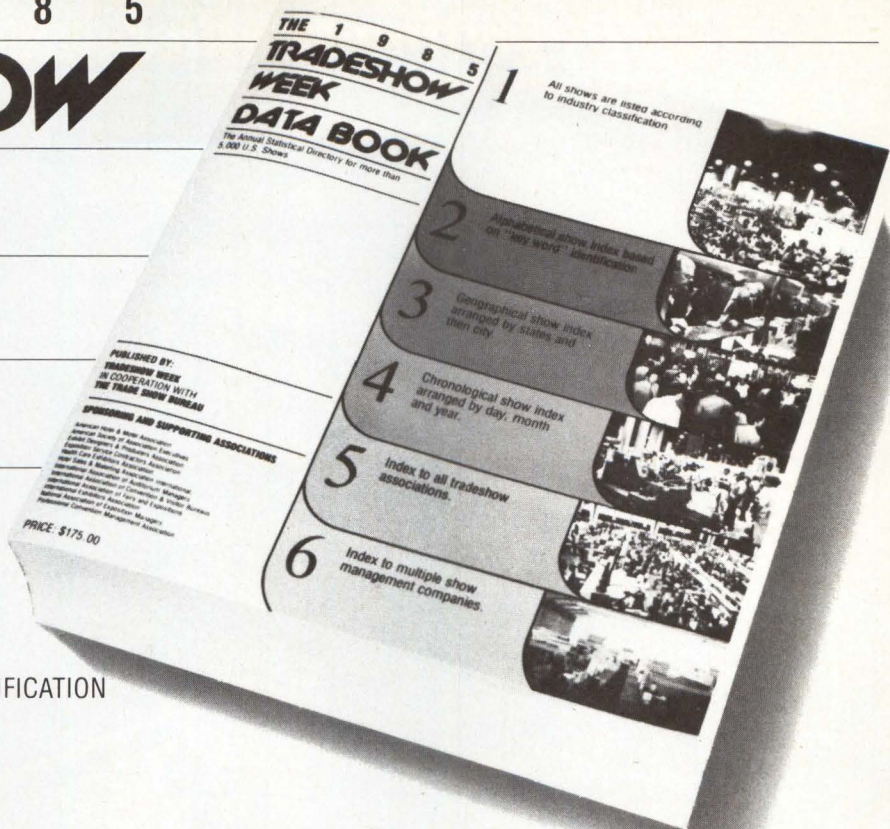

Who Needs The Tradeshow Week Data Book?

CORPORATE EXHIBIT MANAGERS

To plan their tradeshow participation and budgeting by using the DATA BOOK's objective, detailed information.

CORPORATE PLANNING & PURCHASING EXECUTIVES

To decide which shows would be most effective for their purchasing and technical personnel to attend.

ASSOCIATION EXECUTIVES & SHOW MANAGERS

To keep pace with the industry and to place accurate, standardized information about their shows in the hands of potential exhibitors and attendees.

TRADESHOW SUPPLIERS—Convention Bureaus/Hotels/Exhibit Builders/Service Contractors/Airlines and every other professional tradeshow service

To use as a prime sales information resource on key U.S. tradeshows.

Published by **TRADESHOW WEEK** in cooperation with the **TRADE SHOW BUREAU**

(Clip and return to)

Tradeshow Week Data Book
P.O. Box 716
Back Bay Annex
Boston, MA 02117

NAME _____

COMPANY NAME _____

ADDRESS _____

CITY, STATE, ZIP _____

ORDERED BY _____ TITLE _____

YES. We want to order
THE ANNUAL TRADESHOW WEEK DATA BOOK
at \$175.00 per copy.

Check Enclosed Bill Me P.O.# _____

Massachusetts residents please add 5% sales tax.

*The best of everything
keeps getting smaller.*

*Like Persyst's mono and color
display adapters for PC short slots.*

XE PERSYST
EMULEX

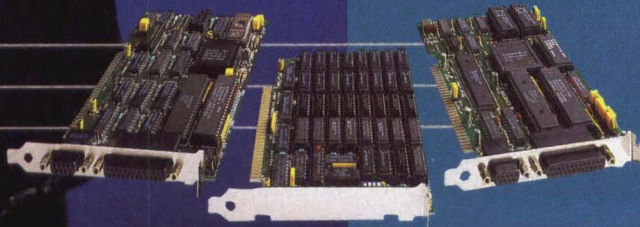

***The Best in
Short-Slot Solutions.***

Now — plug your monochrome or color display adapter into one of your PC/XT's short slots. Using custom VLSI technology, Persyst packs all of the performance of standard IBM display adapters onto short cards. So you can save your long slots for the advanced functions you need.

***The First and Only
Mini-Mono™.***

To maximize your PC slots, Persyst brings you the industry's first short-slot monochrome display adapter — the Mini-Mono Card. Complete IBM compatibility and more: Persyst's parallel port supports not only one, but two industry-standard printer interfaces. And the port's optional, so if you don't need it, you don't have to pay for it.

***The Short Color Card with a
Printer Port.***

Persyst's Short-Port Color™ Card goes way beyond the standard: complete IBM compatibility *plus* printer port all on a six-inch card. So you can get both your color display adapter and printer interface functions into a single short slot.

***Or Fill A Short Slot
with Memory.***

With Persyst's PC/Short Memory™, you can load up to a full 384KB onto a single short card. In fact, Persyst's entire line of PC add-in boards give you more power and performance per slot. So think smaller — and call (800) EMULEX3; in California (714) 662-5600.

Emulex Corporation, 3545 Harbor Blvd., P.O. Box 6725, Costa Mesa, CA 92626
Sony is a registered trademark of Sony Corporation. IBM, IBM PC
and PC/XT are registered trademarks of International Business
Machines Corporation.

CIRCLE NO. 79 ON INQUIRY CARD

Excellence in PC Enhancements.

MINI-MICRO MARKETPLACE

A special section for advertisers of hardware, software and services.

Please circle reader service numbers for additional information.

ENCLOSURE PRODUCTS

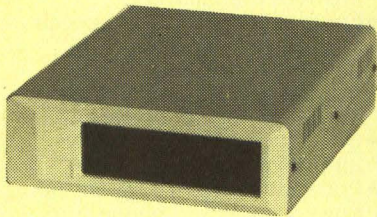

- Floppy and Hard Disk Drives Enclosures for all Major Micros.
- Xebec Controllers Optional
- Custom Design Available
- Class 'B' Certification Support Can Be Provided
- Call For Pricing and Catalog

Microware Inc.

41711 Joy Road • Canton, MI 48187
(313) 459-3557

CIRCLE NO. 201 ON INQUIRY CARD

THE RSX/11M PLUS SPECIALISTS

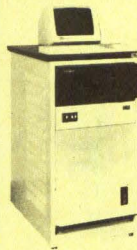

THE LSI-11/73 BASED
CM-300/Q22 COMPUTER
SYSTEMS WITH RSX-11M +
SUPPORTING SUPERVISOR-
MODE LIBRARIES AND
SEPARATE I AND D SPACE

CM-300/Q22 computer systems are configured with DEC's LSI-11/73 CPU, giving these systems 11/70 PERFORMANCE AT LSI-11 PRICES. CM-300/Q22 systems can be configured with up to 1200MB of fixed Winchester disk, up to 4MB of main memory and up to 64 terminals. System back-up is provided by an industry standard 9 track 1/2" 1600 BPI tape drive. Optional software packages include Automatic Date/Time for RSX, Memory Assisted Disk, Cached Pseudo Disk, Memory Dump, Mail List RSX, accounting software, FORTRAN 77, FMS-11, BASIC + 2 and DATATRIEVE. An LSI-11/73 based 300MB system including RSX-11M + license, media and documentation may be purchased for \$21,461.

Call A.C.S. and let us configure a hardware/software solution for your specific problems.

ADVANCED
COMPUTER
SYSTEMS, Inc.

250 Prospect Street
Waltham, Massachusetts 02154
617-894-3278

CIRCLE NO. 202 ON INQUIRY CARD



NEW DIGITAL TEMPERATURE TESTER MODEL 383

Complete temperature tester in one compact hand-held instrument. Features include 3" display, dual type J thermocouple inputs, differential/normal temperature mode, DC millivolt range, analog output. All these features and more in this unique instrument. Unit is supplied with 2 type J glass-braided thermocouples, test lead kit, 9v battery, and operator's manual.

For more information, call 203/359-7613 or write Omega Engineering, One Omega Drive, Box 4047, Stamford, CT 06907.

CIRCLE NO. 203 ON INQUIRY CARD

Now
Available

MINI MICRO SYSTEMS 14th Annual Mini-Micro Computer Market Report

Market data includes:

- 1984 expenditures for minicomputers, microcomputers, peripherals, software and supplies
- 1985 estimated expenditures
- Type of organization
- Geographical breakdown
- Currently owned minicomputers/microcomputers
- 1985 planned purchases of minicomputers/microcomputers
- Plans for switching vendors

The Mini-Micro Computer Market Report, plus an Executive Summary, is available for \$195. Contact your regional sales manager for more information.

CIRCLE NO. 204 ON INQUIRY CARD

YOUR MOVE

Allows you to capture data on your screen and save it for input into subsequent programs. Excellent for moving data amongst programs that don't talk to each other.

ONLY \$29.95

30-day money-back guarantee
Visa/MC accepted
1-800-432-3267
In PA 215-525-1036
Goldata 2 Bryn Mawr Ave.,
Bryn Mawr, PA 19010

CIRCLE NO. 205 ON INQUIRY CARD

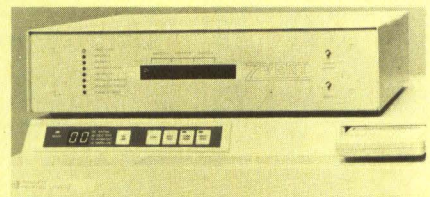

COMPLETE DAISY PRINTER EMULATION

ZVERT ZVT-600 series allows the HP LaserJet to act as an exact replacement for Diablo, Qume, or NEC daisywheel printers. The emulators are stand-alone boxes inserted between a host and the HP LaserJet - no changes to the host hardware or software are needed.

Built-in 3 port sharer supports up to three host computers (2 serial + 1 parallel) and supports DTR, XON/XOFF, and ETX/ACK protocols.

- Complete emulation including justification, centering, tabs, graphics mode, and more.
 - Easy LaserJet set-up from front panel - no escape codes.
- Perfect for OEMS, VARS, SYSTEMS INTEGRATORS, and END USERS to upgrade stand-alone wordprocessors, mini systems and micro systems. Money back compatibility guarantee (Only \$699.00).

P.S. Ask us about our low-cost printer sharers (Only \$499.00).
- FIELD PROVEN - HP LISTED - IN STOCK

ZVERT CORPORATION
12421 VENICE BLVD - SUITE 8, LOS ANGELES, CA 90066
PHONE: 714-675-2525 TLX: 6501760525 MCI

CIRCLE NO. 206 ON INQUIRY CARD

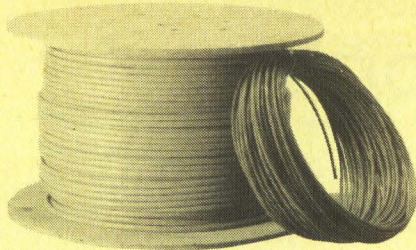

BULK CABLE, CONNECTORS, HOODS AND PARTS — there are times when it's more convenient or expedient to do-it-yourself, such as not being able to anticipate exact cable needs in advance, or having a new cable right now. All kinds of bulk cable in stock for prompt delivery including Fire Retardant; big selection of parts, connectors, hoods. Extended distance multipair Lo-Cap Foil Shielded EDC6 (3 prs.) 22¢/ft. in 500-1,000 ft. reels. Ask for Free new catalog: **Data Set Cable Co.**, 722 Danbury Rd., Ridgefield, CT 06877 — (203) 438-9684; or Las Vegas, NV — (702) 382-6777.

CIRCLE NO. 207 ON INQUIRY CARD

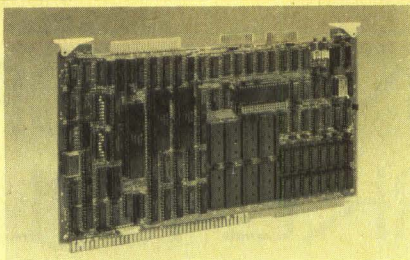

CP/M-8000™ MULTIBUS™ SYSTEM

The CP/M-8000 operating system is now available for our 10 MHz Z8000™ Single Board Computer. This high-performance system has all the familiar CP/M commands. File compatibility with CP/M-80 and CP/M-86 makes it easy to transport files to CP/M-8000. A 'C' compiler and MACRO assembler are included. Call for further information. CP/M™ Digital Research, Multibus™ Intel, Z8000™ Zilog. **SINGLE BOARD SOLUTIONS**, 7669 Rainbow Drive, Cupertino, CA 95014. (408) 253-0181

CIRCLE NO. 208 ON INQUIRY CARD

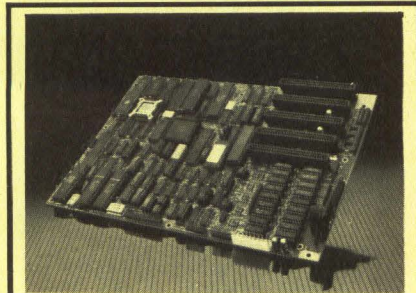

8088 SINGLE BOARD COMPUTER IS IBM PC compatible in form and function. 4.77 MHz Intel 8088 CPU, 8087 socket, 64K to 640K bytes RAM with parity, two 28 pin EPROM sockets, 4 DMA channels, 2 software controlled timers, 5 user available interrupts, floppy controller for up to 4 drives, TTL compatible video output, IBM PC compatible keyboard port, 2 RS-232 serial ports, Centronics printer port, speaker & reset ports, 5 IBM PC compatible I/O expansion slots. BIOS ROM supports MS-DOS, PC-DOS, CP/M-86, Concurrent CP/M, PC-iRMX. **DAVIDGE CORP.**, PO Box 1869, Buellton, CA 93427 (805) 688-9598.

CIRCLE NO. 210 ON INQUIRY CARD

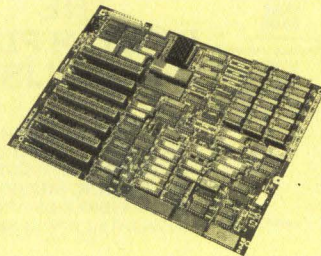

**8 Mhz 80286
IBM PC/XT MOTHERBOARD**

- 9 Times Faster Than PC; 65% Faster Than AT
- 1MB Ram On-Board; Zero Wait States
- Optional 80287 Math Co-Processor
- PC/XT Hardware & Software Compatible
- Supports PC-DOS, Unix, Pick, CP/M-86, SMCOS



WAVE MATE, Inc.
14009 S. Crenshaw Blvd.
Hawthorne, CA 90250
(213) 978-8600 TLX 194369
In Europe: Brussels 649-1070 TLX 61828

CIRCLE NO. 211 ON INQUIRY CARD

T-310 Telephone Access Unit

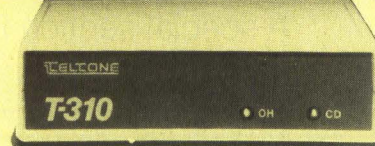

Connect the unlimited capabilities of your computer to the telephone system

- A complete telephone line controller
- FCC-approved for direct connection
- RS-232 compatible
- Provides call following
- Couples audio sources (speech synthesizers, tape players) onto the phone line
- Permits remote data entry from any Touch-Tone phone anywhere
- Offers incoming call security—up to 15 digits
- Priced at less than \$375, including power supply and phone cord

Use the T-310 and your computer to dial and control outgoing calls or receive incoming calls—automatically! For more information, call Teltone today:

(206) 827-9626, ext. 437



Teltone Corporation, P.O. Box 657
Kirkland, WA 98033
In Canada contact Teltone Ltd., 183 Amber St., Markham,
Ontario L3R 3B4, (416) 475-0837

CIRCLE NO. 212 ON INQUIRY CARD

ORDER FORM

Advertise in the **MINI-MICRO MARKETPLACE**

Please run my advertisement in the following issues : Jan Feb Feb 15 March
April April 15 May June June 15 July Aug Sept Oct Nov Nov 15 Dec

EFFECTIVE JANUARY 1986

1x	3x	6x	12x	18x
\$660	\$595	\$575	\$560	\$545
	24x	48x		
	\$525	\$505		

MATERIALS

1. Glossy photo with 50-75 words.
We will typeset your ad at no charge.
2. Camera ready artwork.
3. Film negatives: right reading emulsion side down.

AD SIZE: 2 1/4" x 3 1/16"

COMPANY _____

ADDRESS _____

CITY _____ STATE _____ ZIP _____

TELEPHONE _____

SIGNATURE _____

Space reservation by the first week of the month proceeding issue date.

- Materials enclosed Materials to come Please send information

Send to: Carol Flanagan • **MINI-MICRO SYSTEMS**
275 Washington St.
Newton, MA 02158

15% Agency commission to accredited agencies. Please specify agency.

We've Earned The Right To Be #1 By Being First So Often

When it comes to being **FIRST** with technology-leading products **Advanced Digital** wears its #1 button with pride. We were **FIRST** to introduce an 8-Bit, single board S-100 computer... We were **FIRST** to introduce a 6MHz, 128KByte single board computer... We were **FIRST** to introduce a 6MHz, 128KByte Slave Processor board. Our record of **FIRSTS** continues with...

- The introduction of **MULTI SLAVE** - a 3 USER, 8MHz SLAVE card for the S-100 Bus systems running Turbo-Dos™ or NETWORK/O/S.*
- The introduction of **HDC-2001**, the all new hard disk controller for the S-100 BUS.
- The introduction of **SUPER 16**, a 16-Bit, S-100 Slave card for use with Turbo-Dos or NETWORK O/S.
- The introduction of our new **SUPER 186** - the **FIRST** 16-Bit, single board S-100 computer that performs at twice the speed of older technologies. Loaded with features such as on-board floppy disk controller and up to 1MByte of RAM, the SUPER 186 is designed to function as a bus Slave or Master. Advanced Digital's SUPER 186 permits you to take advantage of vast libraries of sophisticated applications software.

Again, we were #1 with...

- The introduction of **PC-SLAVE**, an IBM PC Multiuser card with 8088 (8MHz) CPU and 256-768K RAM on board.

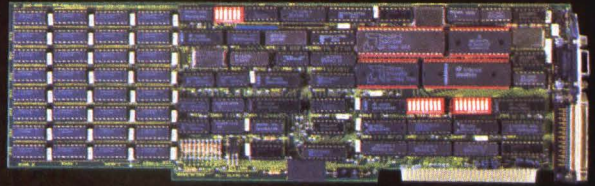

When it comes to selecting your S-100 boards, go with **Advanced Digital** - the recognized industry leader.

See your local computer dealer or contact **Advanced Digital** today for more information on the new **PC-SLAVE**, and the complete line of S-100 single board computers and multiuser systems.

**ADVANCED
DIGITAL
CORPORATION**

Leading
the Microcomputer
Technology

Advanced Digital • 5432 Production Drive, Huntington Beach, CA 92649 • Tel. (714) 891-4004 • Telex 183210 ADVANCED HTBH
Advanced Digital U.K. Ltd. • 27 Princes St., Hanover Square • London W1R8NQ • United Kingdom • (01) 409-0077 • (01) 409-3351 • Telex 265840 FINEST
Toll Free (1-800) 251-1801
(Outside California)

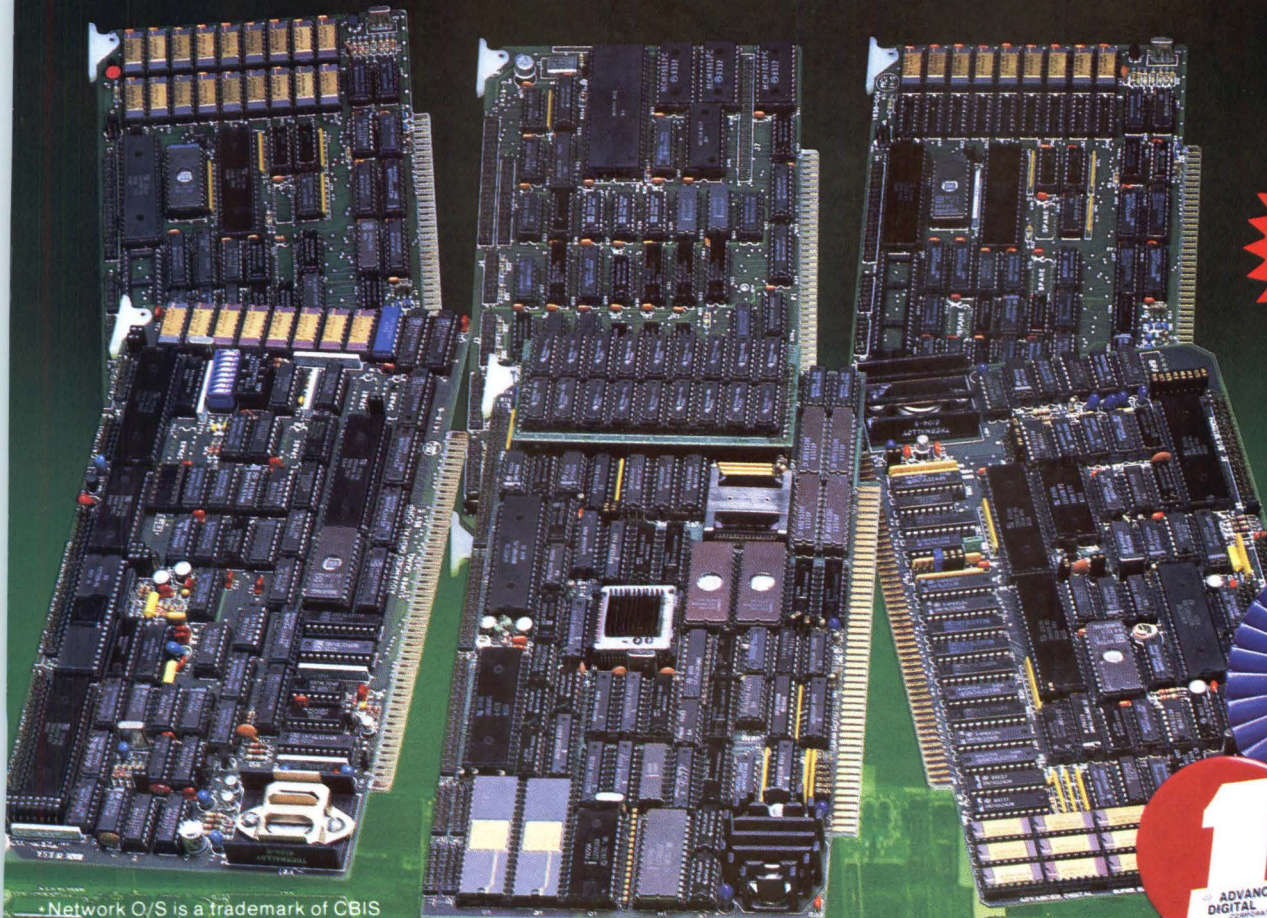

SEE
US AT
ATLANTA
COMDEX
'86

1
ADVANCED
DIGITAL
CORPORATION

*Network O/S is a trademark of CBIS
*CP/M is a trademark of Digital Research
*TurboDOS is a trademark of Software 2000

CIRCLE NO. 68 ON INQUIRY CARD



Dial Now, Dedicate Later at 9600 bps

Take your datacomm system to 9600 bps *now*. You can do it with UDS 9600A/B modems! Buy them today and instantly speed up your system *on the dial-up network*. Later, when traffic growth demands an upgrade, three simple strap changes will adapt your modems to dedicated lines.

The UDS 9600A/B provides optional data rates of 7200 and 4800 bps. Communication may be half-duplex (two-wire) or full-duplex (four-wire, V.29). A wide range of integral test capabilities simplifies system diagnostics.

Don't wait to accelerate your datacomm system throughput. Dial-up or dedicated, you can move

to 9600 bps now. For complete details, contact Universal Data Systems, 5000 Bradford Drive, Huntsville, AL 35805. Phone 205/837-8100. Telex 752602 UDS HTV.

QUANTITY ONE PRICE \$1,995



Universal Data Systems

MOTOROLA INC.
Information Systems Group

UDS modems are offered nationally by leading distributors. Call the nearest UDS office for distributor listings in your area.
DISTRICT OFFICES: Atlanta, GA, 404/998-2715 • Aurora, CO, 303/368-9000 • Blue Bell, PA, 215/643-2336 • Boston, MA, 617/875-8868 • Columbus, OH, 614/895-3025 • East Brunswick, NJ, 201/238-1515 • Glenview, IL, 312/998-8180 • Houston, TX, 713/988-5506 • Huntsville, AL, 205/837-8100 • Issaquah, WA, 206/392-9600 • Mesa, AZ, 602/820-6611 • Milwaukee, WI, 414/273-8743 • Minnetonka, MN, 612/938-9230 • Mountain View, CA, 415/969-3323 • Richardson, TX, 214/680-0002 • St. Louis, MO, 314/434-4919 • Silver Spring, MD, 301/942-8558 • Tampa, FL, 813/684-0615 • Thousand Oaks, CA, 805/496-3777 • Tustin, CA, 714/669-8001 • Uniondale, NY, 516/222-0918 • Willowdale, Ont, Can, 416/495-0008 • Ypsilanti, MI, 313/483-2682

CIRCLE NO. 69 ON INQUIRY CARD

Created by Dayner/Hall, Inc., Winter Park, Florida