

altair<sup>TM</sup> 88-16K

STATIC RAM CARD  
(88-16 MCS)



mits

altair 88-16K  
STATIC RAM CARD  
(88-16 MCS)



## TABLE OF CONTENTS

Theory of Operation . . . . .	page 1
88-16MCS Timing Diagram . . . . .	page 5
88-16MCS Layouts. . . . .	page 7
88-16MCS Schematics . . . . .	page 11
Assembly Procedure. . . . .	page 17

16K STATIC  
PARTS LIST  
APRIL, 1976

BAG 1

1	7402	101021
1	74L02	101072
1	7406	101054
5	74L04	101073
1	74LS27	101103
1	74LS74	101088
1	74L139/93L21	101138
1	8212	101071
2	8T97/74367/8097	101040
1	7805	101074
1	7812	101085

BAG 2

32	4200	101137
----	------	--------

BAG 3

3	33MF 16V	100326
51	.1MF 12V	100348

BAG 4

5	330 Ohm $\frac{1}{2}$ W	101926
1	100 Ohm 2W	102009
1	5V Zener	100721

BAG 5

32	22 Pin Socket	102108
----	---------------	--------

BAG 6

2	Heat Sink (Small)	101870
2	Card Guides	101714
1	100 Pin Connector	101864
6	#6-32 x 3/8" Screw	100925
2	#6 Nut	100933
2	#6 Lock Washer	100942
1	24 Pin Socket	102105
1	4-Pos. SPST Dip Switch	102348

MISC.

1	16K Static PC Board	100194
1	16K Static Manual	101565

88-16 MCS  
THEORY OF OPERATION



## 88-16MCS THEORY OF OPERATION

The 88-16MCS is based around a 4096 X 1 bit static random access integrated circuit. These RAMs offer the advantage of low power consumption and extremely fast access time (215 ns.), and also eliminates the need for the additional refresh logic common to most dynamic memories.

### BOARD/BLOCK SELECT

See Schematic and Timing Diagram at the end of this section. Since only four 88-16MCS boards are required for the maximum amount of memory directly accessible by the computer, only the upper two address bits (A14 and A15) are required to select a particular board. IC G is a dual 2 to 4 decoder that selects one of four outputs according to the state of A14 and A15. These outputs are fed to SW-1, which selects the board through one of the switches by enabling the input control signals at gates M2, M10, and N3. This signal is labeled TP1 on the schematic. TP1 enables the remaining 2 to 4 decoder of IC G. This decoder selects one of four 4096-word memory blocks according to address bits A12 and A13. Thus the upper four address bits select a single 4K block on a particular 16K card. The remaining twelve address bits are buffered and inverted through ICs R and T to select one location within a block.

### READ

See timing diagram at the end of this section. When the address (TP1), PSYNC (M1) and D07 (H8) are all true (M13, 2 and 1), M12-K12 cause K9 to go high when Q1 goes high at K11. [During PSYNC and Q1, D7 is latched on the CPU board and becomes SMEMR on the system bus. D07 is used instead of SMEMR at IC K so that the read status will be valid earlier.] This forces M6 low to partially enable gates F (F3, 6, 9, and 12). One of the four block-select outputs (G4, 5, 6, or 7) will be low to cause one of the gates (F) to go active. This provides a  $\overline{CS}$  (chip select) signal through IC E to one of the blocks of eight RAMs for a valid 8-bit read.

N13 is forced high by M6 to enable data latch IC S at pin 11. 500 nanoseconds after the read sequence begins, Q1 again goes high. K12 is low at this time, causing K9 to go back low. This forces  $\overline{CS}$  back high (to +12 volts) and S11 low, which latches the data in IC S. It is necessary to latch the data for display when the computer is stopped. Continued RAM selection ( $\overline{CS}$  = low) is undesirable, since the RAMs consume much more power when selected.

The CPU requests data by forcing PDBIN high. When PDBIN, SMEMR and TP1 are valid (see above) M8 goes high and L2 low (TP3) to enable the data buss drivers, IC V and W2-3, 4-5 for 500 nanoseconds (the pulse width of PDBIN). In the stopped mode, the buss drivers are enabled to display data (PDBIN remains high).

## WRITE

The MWRITE signal defines that a memory write is taking place. This signal is a gating of  $\overline{PWR}$ , the actual write pulse from the CPU, and  $\overline{OUT}$ , a signal that defines a memory cycle as opposed to an output operation. This gating takes place on the C/D board and MWRITE is brought out to buss line 68.

The MWRITE signal is buffered and inverted through L13-12 to N2 and E3. With TP1 valid at N3, N1 goes high, forcing M6 low. When M6 goes low, CS is forced low as described in the READ section.

The R/W (TP4) signal into the RAMs is forced high by E4 and W14-13 for write operations. When the computer is in the run mode, the write sequence is active for 500 nanoseconds (the pulse-width of MWRITE). When the computer is in the stopped mode, a front-panel deposit occurs for a greater amount of time, defined by the C/D board deposit logic.

The data presented by the CPU during a write cycle is buffered/inverted at IC U and H5-6, 9-8. The data is again inverted within the RAMs when accessed during a read so that after two inversions, the written data equals the read data.

## POWER SUPPLY

The unregulated +5 and +V voltages are filtered by C2 and C5 and regulated through VR-2 and VR-1 to produce regulated +5 volts and +12 volts, respectively. The -V is filtered by C1, fed through R6, a current limiting resistor, and regulated to -5 volts by zener diode D1.

The remaining .1  $\mu$ f capacitors are used for noise suppression. The currents drawn from these supplies are listed below:

+5 volts	400 milliamps
+12 volts	160 milliamps
-5 volts	100 milliamps



# READ/WRITE TIMING

NOTE: EACH STATE (T1, T2, T3) IS  
APPROXIMATELY 500 NANoseconds

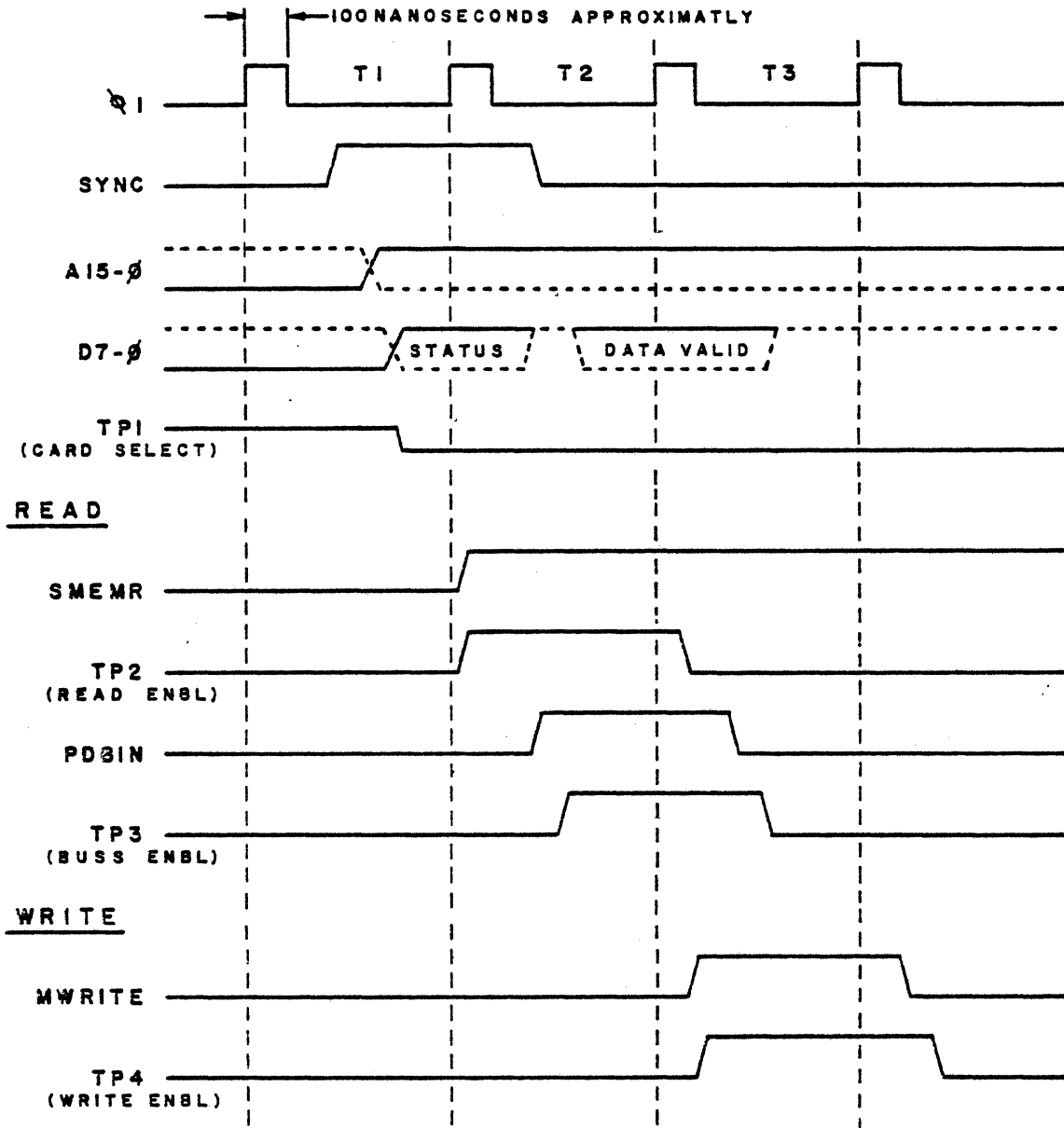



88-16MCS Layout (Top)

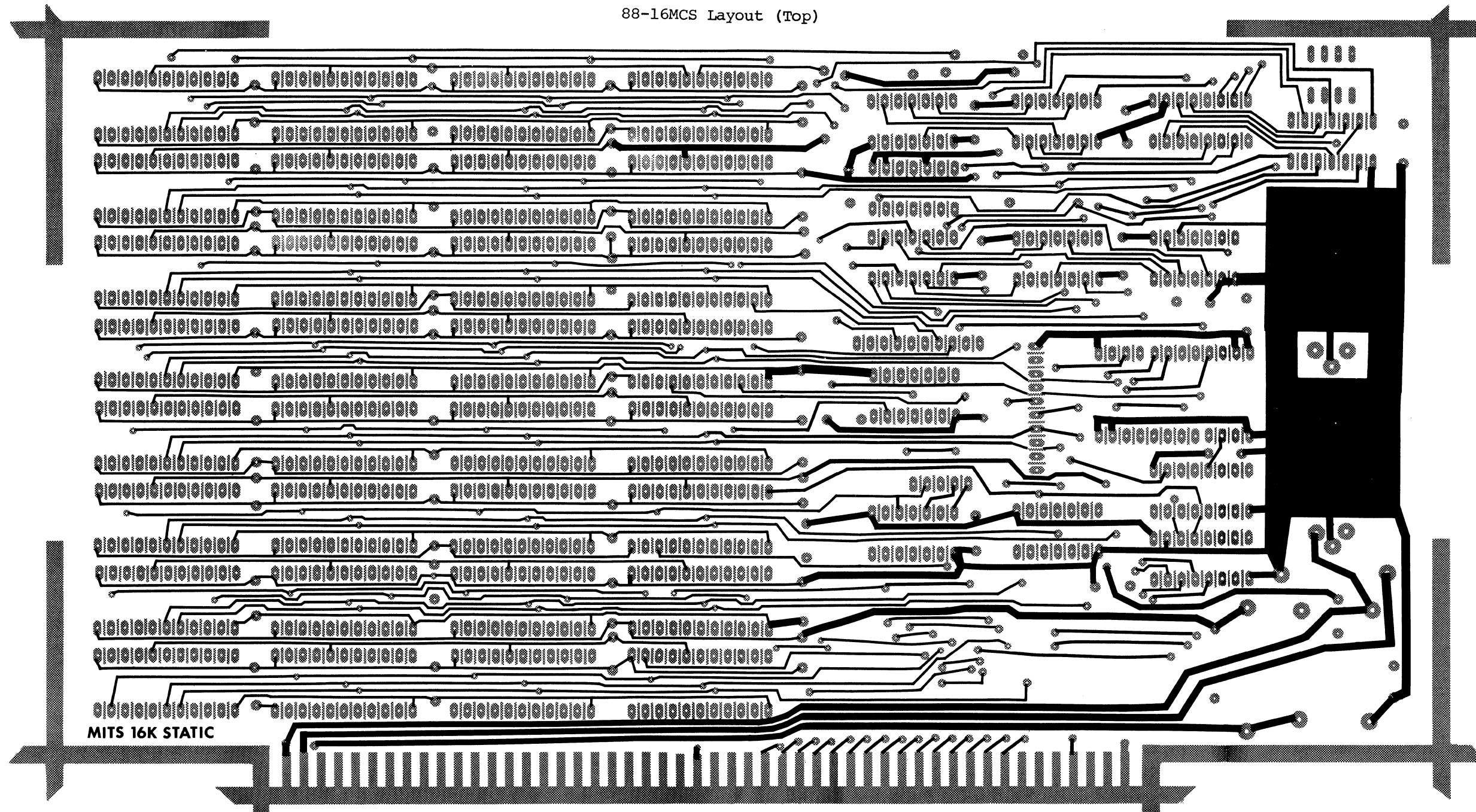

MITS 16K STATIC



88-16MCS Layout (Bottom)

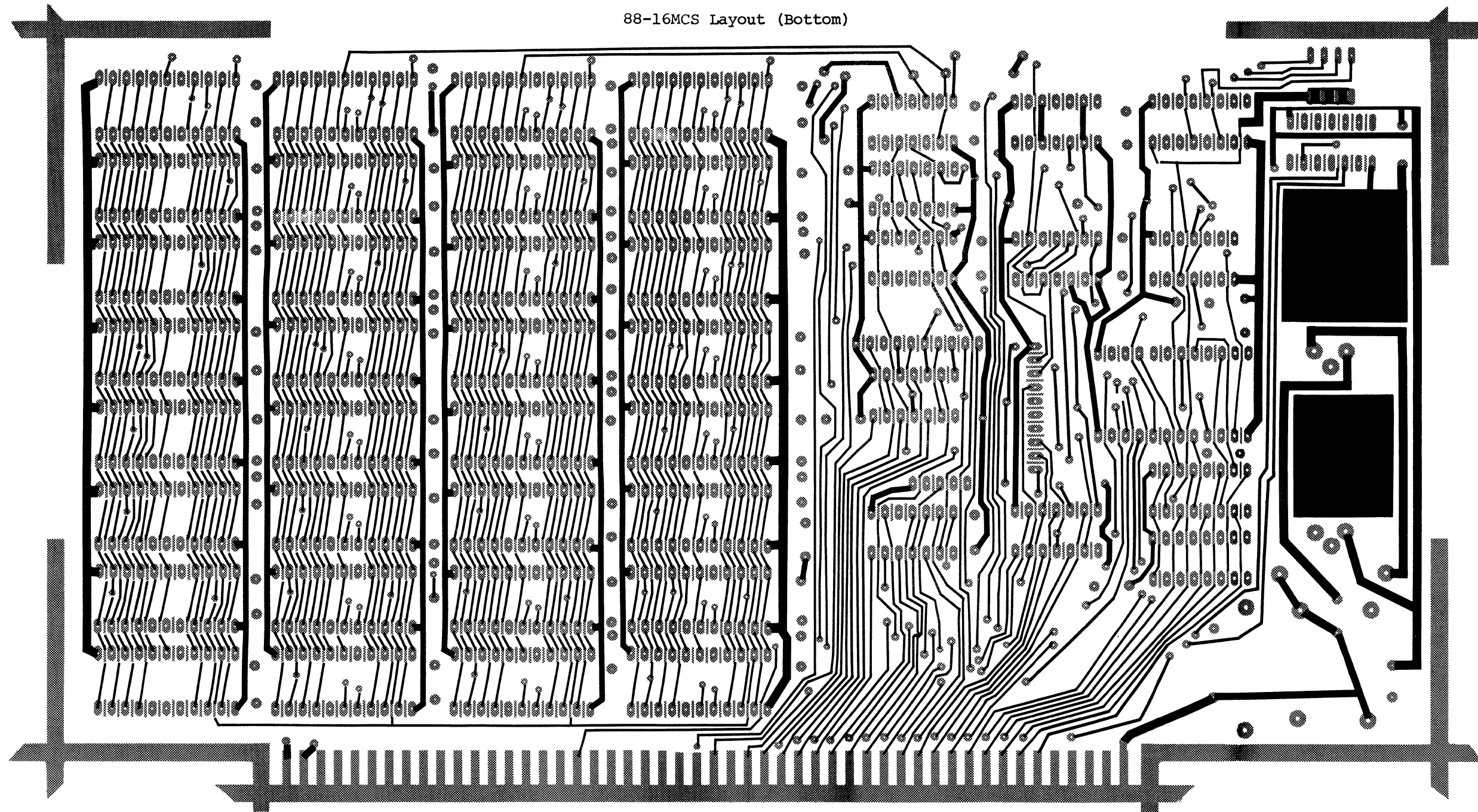



1 51

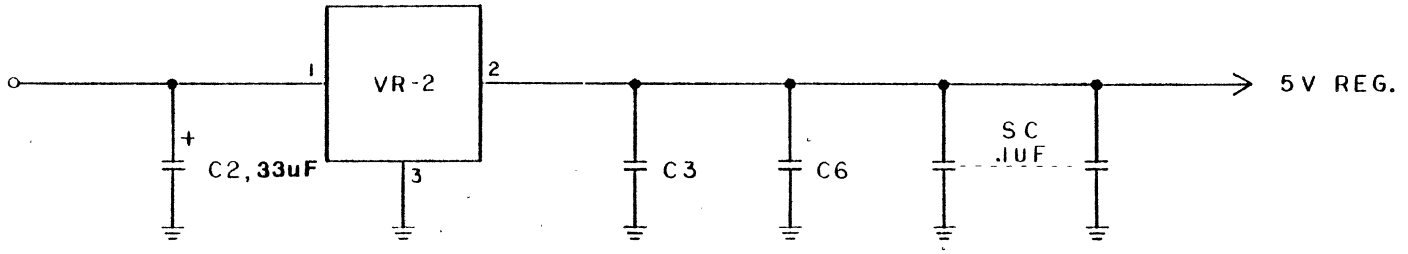

2

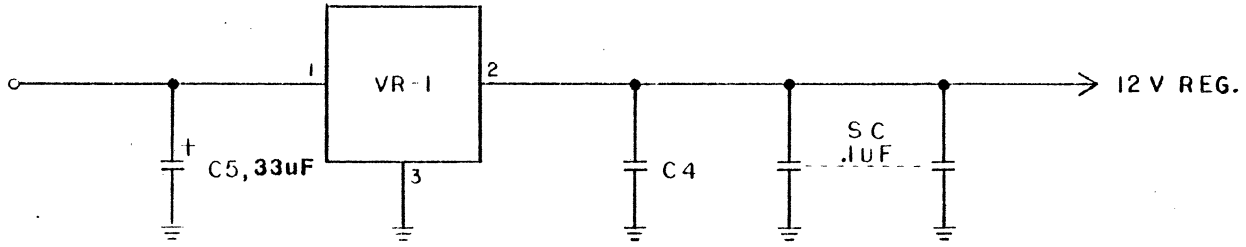

52

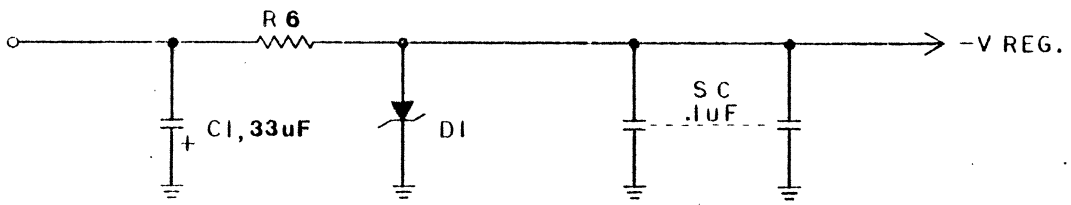

<b>16K STATIC POWER SUP.</b>			
DRAWN BY	DATE	CHECKED BY	DATE
J.D.	3/30		
ENGINEER	DATE	SCALE	
<small>                 DOWNSHIP INFORMATION: THIS DRAWING IS THE PROPERTY OF MITSUBISHI ELECTRIC CORPORATION AND SHALL BE KEPT AS SUCH. IT IS TO BE USED ONLY FOR THE PROJECT AND SHALL NOT BE REPRODUCED OR TRANSMITTED IN ANY FORM OR BY ANY MEANS WITHOUT THE WRITTEN PERMISSION OF MITSUBISHI ELECTRIC CORPORATION.             </small>			DOWNSHIP NO. <b>8800 - 150</b>





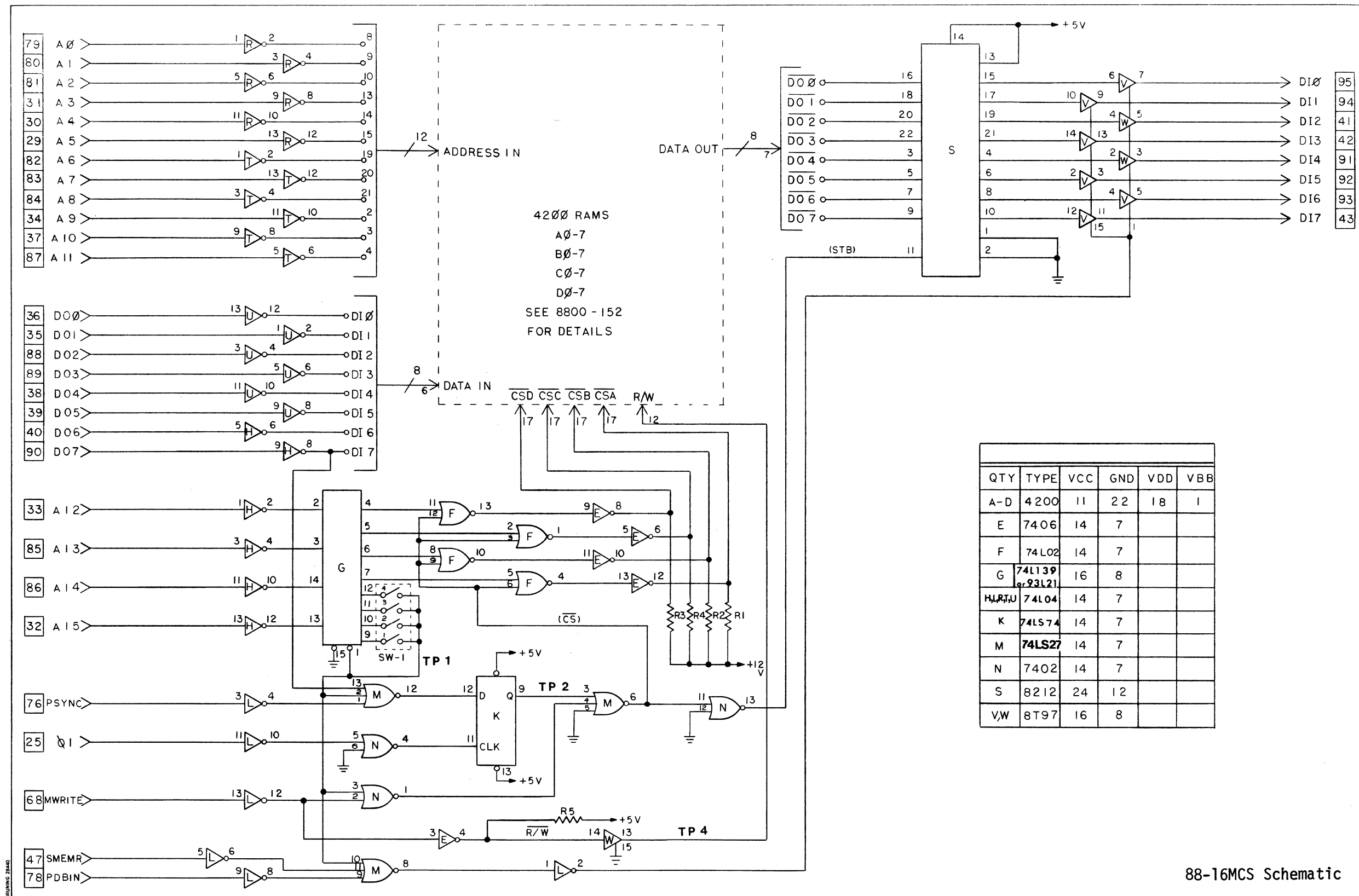



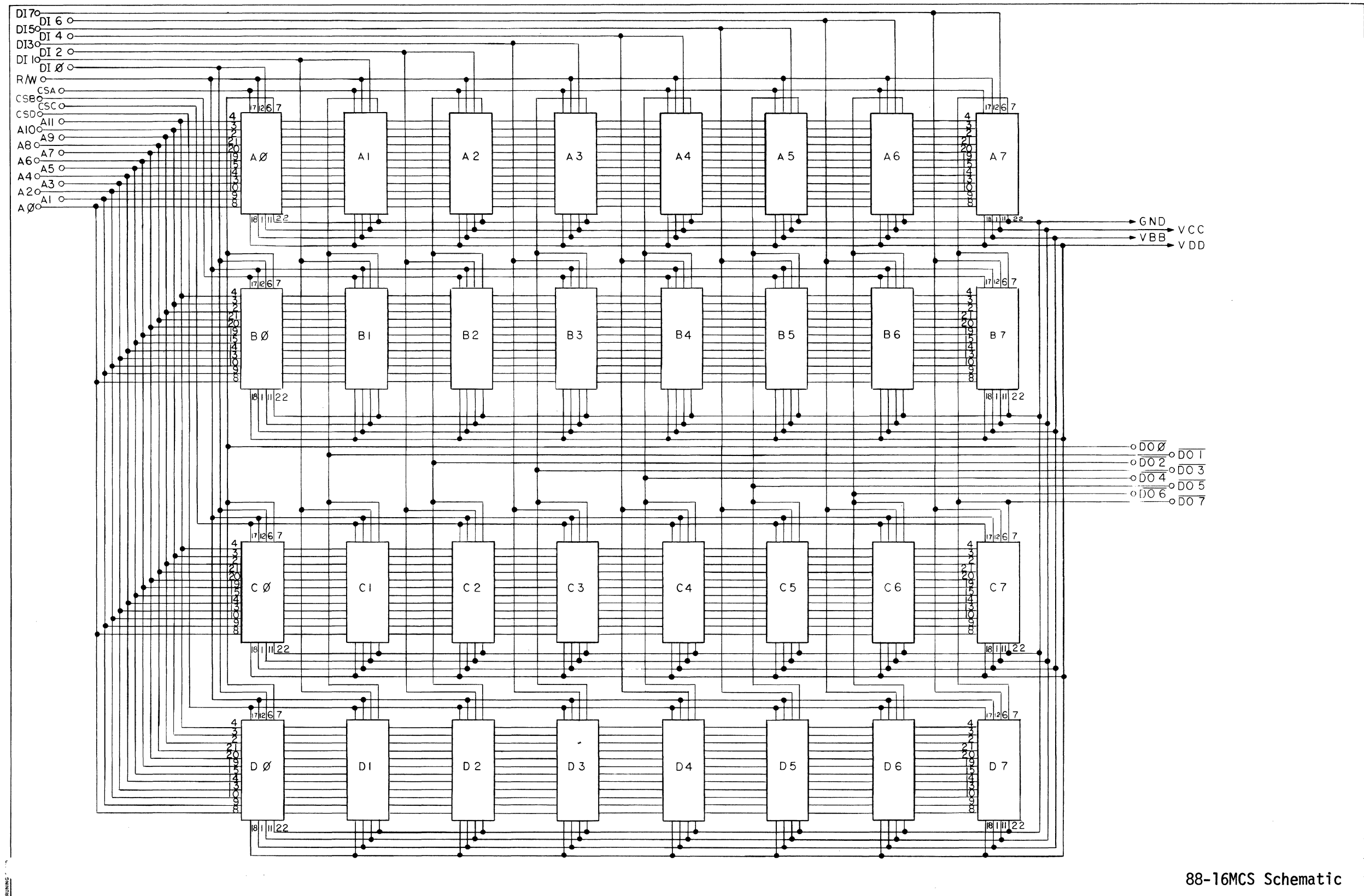



88-16 MCS  
ASSEMBLY PROCEDURE



## PRINTED CIRCUIT BOARD VISUAL INSPECTION

It is recommended that a visual inspection of the PC Board(s) in your kit be made before beginning the assembly procedures.

Look for etching "bridges" or etching "opens" in the printed circuit lands, as shown in the drawings below:

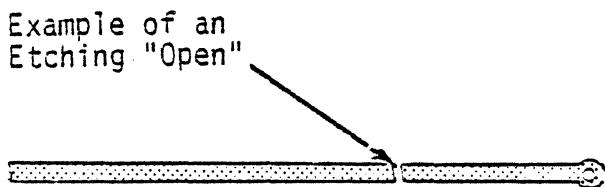
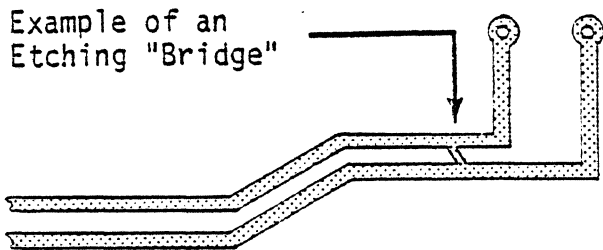

This could also appear as a "hairline" cut.

A thorough visual inspection will eliminate one possibility for errors, should the board not operate properly after it is assembled. Troubleshooting efforts may then be concentrated elsewhere.

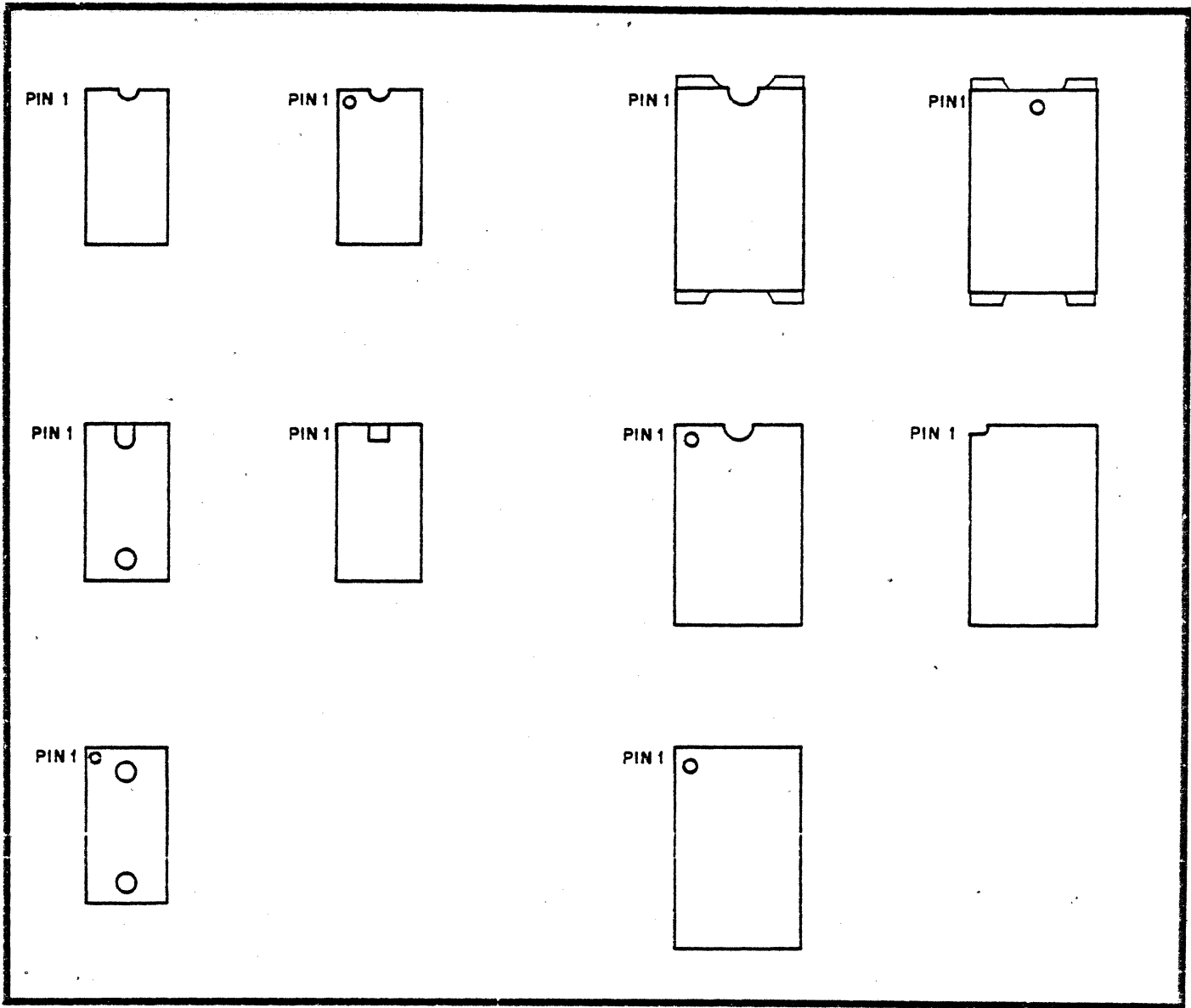

INTEGRATED CIRCUITS (ICs) CAN COME WITH ANY ONE OF, OR A COMBINATION OF, SEVERAL DIFFERENT MARKINGS. THESE MARKINGS ARE VERY IMPORTANT IN DETERMINING THE CORRECT ORIENTATION FOR THE ICs WHEN THEY ARE PLACED ON THE PRINTED CIRCUIT BOARDS. REFER TO THE ABOVE DRAWING TO LOCATE PIN 1 OF THE ICs, THEN USE THIS INFORMATION IN CONJUNCTION WITH THE INFORMATION BELOW TO PROPERLY ORIENT EACH IC FOR INSTALLATION.

**WARNING: INCORRECTLY ORIENTED IC'S MAY CAUSE PERMANENT DAMAGE!**

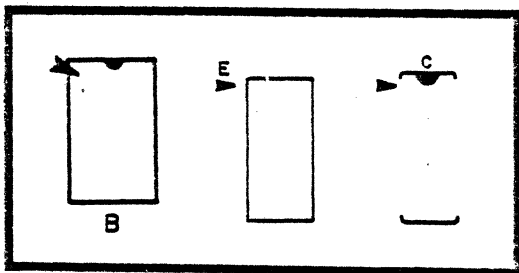

THE DRAWING ON THE LEFT INDICATES VARIOUS METHODS USED TO SHOW THE POSITION OF ICs ON THE PRINTED CIRCUIT BOARDS. THESE ARE SILK-SCREENED DIRECTLY ON THE BOARD. THE ARROWHEAD INDICATES THE POSITION FOR PIN 1 WHEN THE IC IS INSTALLED.



## SOCKET AND IC INSTALLATION

There are 32 22-pin sockets to be installed on the 88-16MCS. Referring to the component layout on this page, note rows A, B, C and D. Install sockets A0-A7, B0-B7, C0-C7 and D0-D7 according to the following instructions.

1. Be certain that the socket pins are straight. If any of the pins are bent, CAREFULLY straighten them with the tip of a small screwdriver.
2. Set the socket into place and secure it with a piece of masking tape.
3. Turn the board over and solder each pin to the foil pattern on the back of the board. Be sure that EACH pin is soldered, and be careful not to leave any solder bridges.

4. Turn the board over again, and remove the masking tape.

SOCKETS	PINS
A0-A7	22
B0-B7	22
C0-C7	22
D0-D7	22

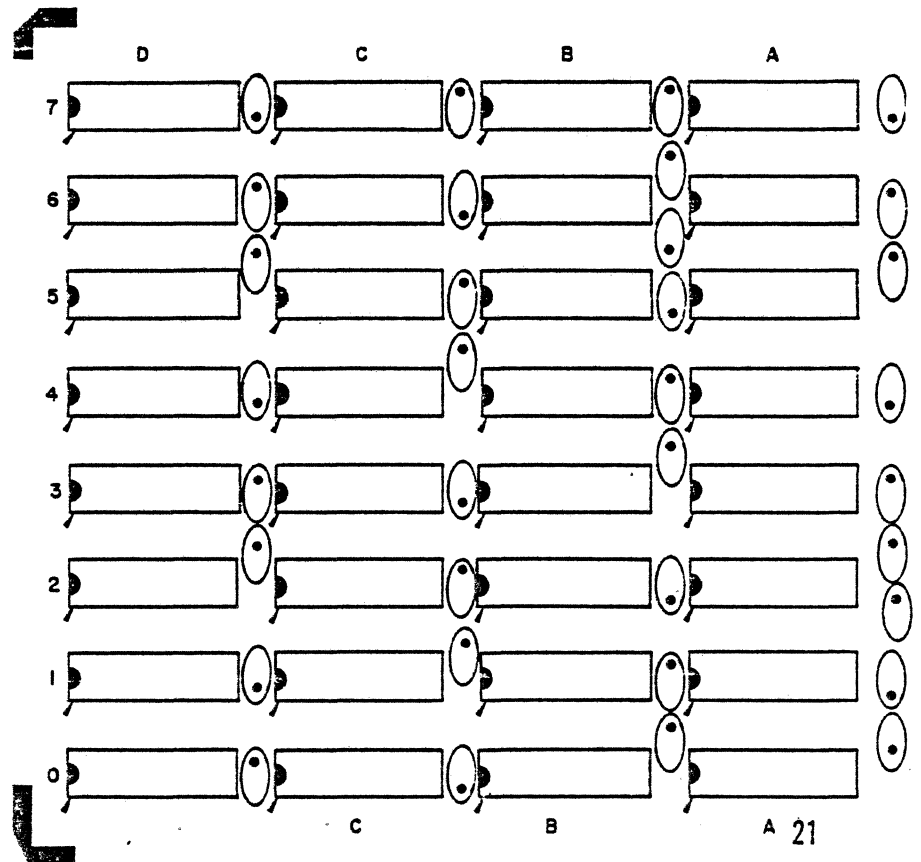
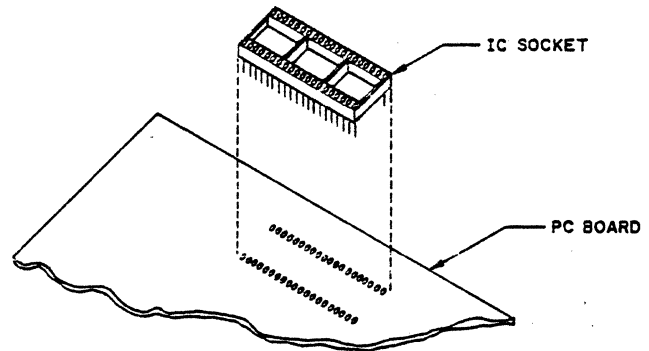

There is one 24-pin socket to be installed on the other half of the 88-16MCS. Referring to the component layout and parts chart below, install socket "S" according to the instructions (steps 1-4) on the preceding page.

SOCKET	PINS
S	24

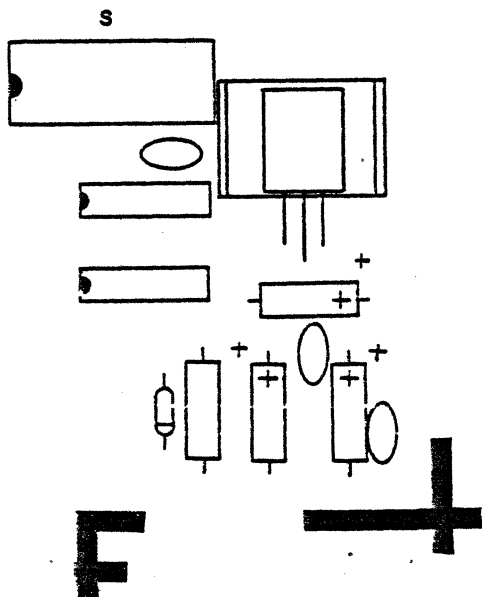

**NOTE**

The 33 sockets you have just installed are provided for static-sensitive ICs. **DO NOT INSTALL** the corresponding ICs (A0-A7, B0-B7, C0-C7, D0-D7, S) until after the entire board is assembled.

Thirteen ICs (E, F, G, H, K, L, M, N, R, T, U, V, W) will be soldered directly to the board.

To prepare the ICs for installation:

Referring to the component layout on the next page, remove the IC with the correct part number from its holder. If there are any bent pins, straighten them with a needle-nose pliers. Ensure that you choose the IC with the correct part number as you install each one.

Install the ICs according to the following procedure:

1. After the IC is correctly oriented, start the pins on one side of the IC into their respective holes on the silk-screened side of the PC board. **DO NOT PUSH THE PINS IN ALL THE WAY.** If you have difficulty getting the pins into the holes, use the tip of a small screwdriver to guide them.
2. Start the pins on the other side of the IC into their holes in the same manner. When all of the pins have been started, set the IC into place by gently rocking it back and forth until it rests as closely as possible to the board. After you are certain that the IC is perfectly straight, tape it in place with a piece of masking tape.
3. Turn the board over and solder each pin to the foil pattern on the back side of the board. Be sure to solder **EACH** pin, and be careful not to leave any solder bridges.
4. Turn the board over again, and remove the piece of masking tape.
5. After each IC is installed, check the corresponding part off of the list provided on the next page.

ICs		
Designation		Number
( )	E	7406
( )	F	74L02
( )	G	74LS139 or 93L21
( )	H	74L04
( )	K	74LS74
( )	L	74L04
( )	M	74LS27
( )	N	7402
( )	R	74L04
( )	T	74L04
( )	U	74L04
( )	V*	8T97
( )	W*	8T97

\*Note that ICs "V" and "W", 8T97 may be substituted with a 74367 or 8097 chip.

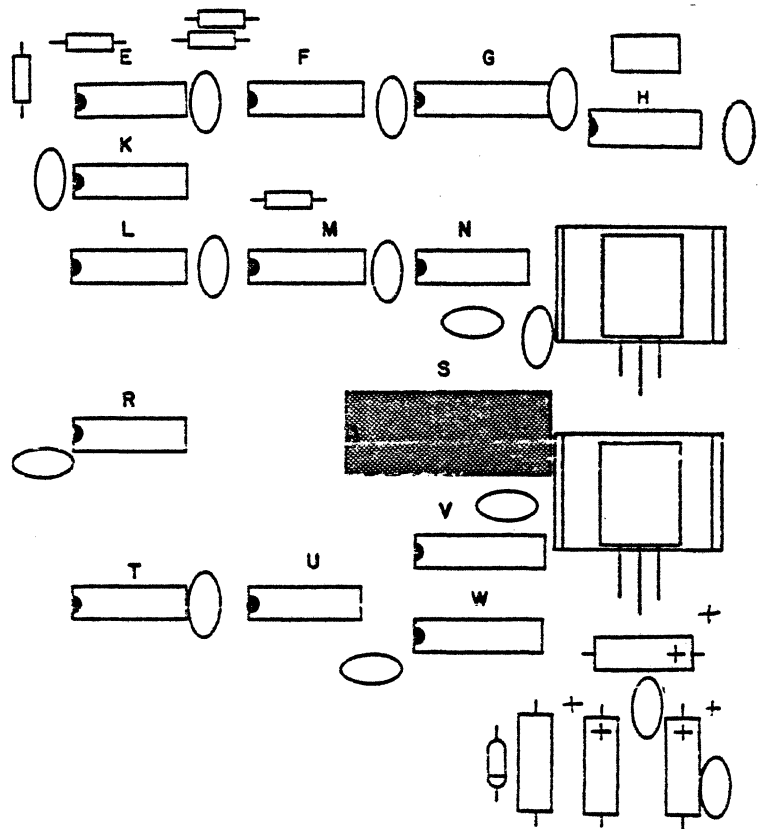

## RESISTOR INSTALLATION

There are six resistors (R1, R2, R3, R4, R5, R6) to be installed on the 88-16MCD.

### NOTE

Resistors are color-coded according to their value. The resistors in your kit will have four bands of color. The fourth band in both cases will be gold or silver, indicating the tolerance. In the following instructions, only the 3 bands of color to one side of the gold or silver band are significant. Be sure to match these three bands of color with those called for in the instructions as you install each resistor.

Refer to the component layout and the parts list on this page, and install the resistors according to the following procedure:

1. Match the color bands designated on the parts chart with the resistor position indicated by the component layout.
2. Using needle-nose pliers, bend the leads of the resistor at right angles to match their respective holes on the board.
3. Insert the resistor into the correct holes from the silk-screened side of the board. Push the resistor down until it touches the foil pattern.
4. Holding the resistor in place, turn the board over and bend the leads slightly outward.

5. Solder the two leads to the foil pattern on the back side of the board. Clip off any excess lead lengths, and save them for hard-wire connections to be made later.
6. After making sure that there are no solder bridges, check the resistor off of the parts list.

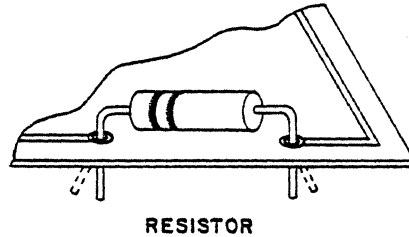

### RESISTORS

- |     |                                      |
|-----|--------------------------------------|
| ( ) | R1, orange-orange-brown, 1/4 or 1/2W |
| ( ) | R2, orange-orange-brown, 1/4 or 1/2W |
| ( ) | R3, orange-orange-brown, 1/4 or 1/2W |
| ( ) | R4, orange-orange-brown, 1/4 or 1/2W |
| ( ) | R5, orange-orange-brown, 1/4 or 1/2W |
| ( ) | R6, brown-black-brown, 2W            |

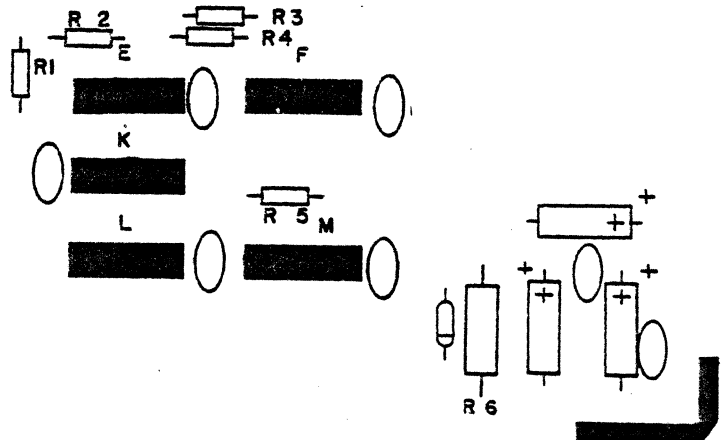

## CAPACITOR INSTALLATION

There are 34 .1 mf ceramic disk capacitors to be installed on the left-hand side of the PC board. The silk screen designations appear on the board as follows.  \* These capacitors are not numbered. Referring to the component layout on this page, install the ceramic disk capacitors according to the instructions below:

1. Using needle-nose pliers, straighten the two leads as necessary to fit their respective holes on the board.

2. Insert the capacitor into the correct holes from the silk-screened side of the board. Push the capacitor down until the ceramic insulation almost touches the foil pattern.
3. Holding the capacitor in place, turn the board over and bend the two leads slightly outward. Solder the leads to the foil pattern and clip off any excess lead lengths.

\* Ignore dots that appear on silk-screen designation.

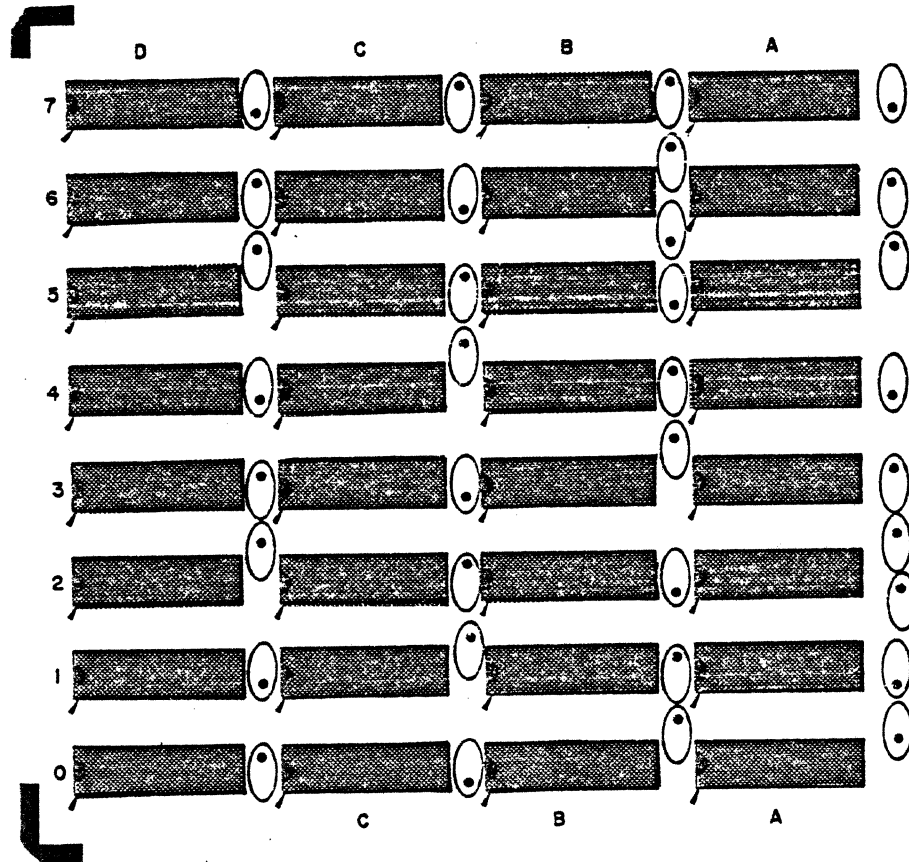

There are 15 .1 mf ceramic disk capacitors to be installed on the 88-16MCS. Three of the ceramic disk capacitors are numbered, C3, C4 and C6. The other twelve capacitors are marked only by the following designation: ○

Referring to the component layout on this page, install the ceramic disk capacitors according to the instructions (steps 1, 2 and 3) on the preceding page.

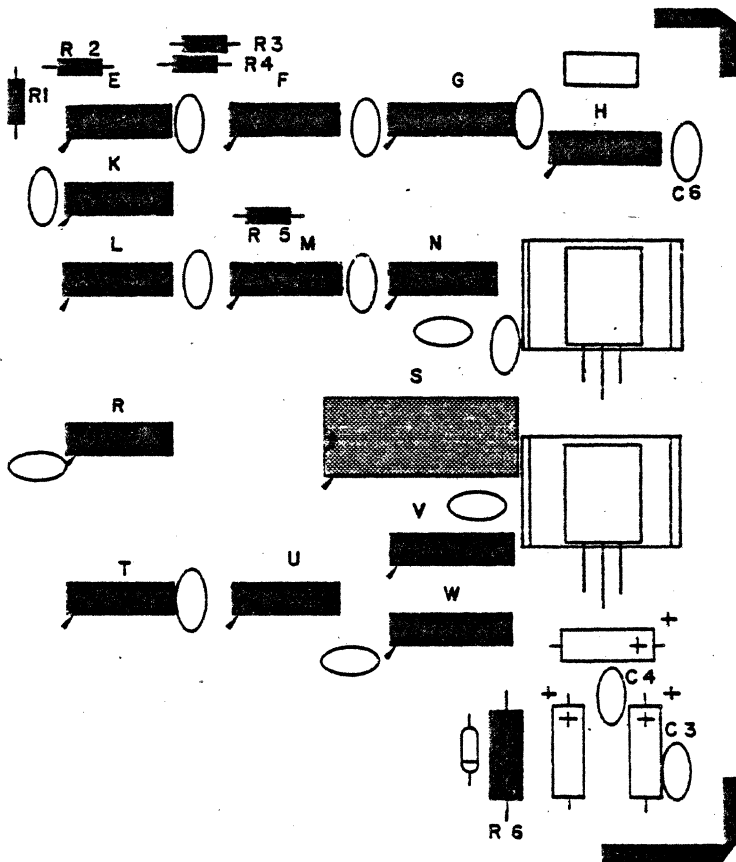

There are three 33 mf electrolytic capacitors to be installed on the 88-16MCS.

The polarity markings of each electrolytic capacitor will appear as one of the following types:

ELECTROLYTIC CAPACITOR

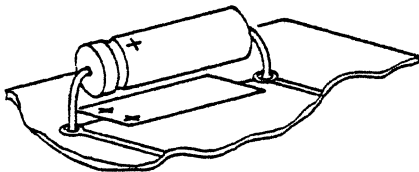

ELECTROLYTIC CAPACITOR

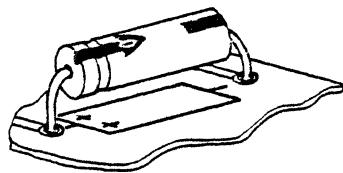
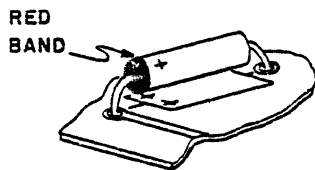

If the marking is the arrow type, a negative sign will appear in the tip of the arrow. Orient the capacitor so that the arrow points to the negative polarity side. If the marking is one of the other two types, orient the capacitor so that the positive signs match the positive polarity side. Polarity is designated on the silk-screened side of the board.

Referring to the component layout and the parts chart on this page, install each electrolytic capacitor as follows:

1. Bend the two leads of the capacitor at right angles to match their respective holes on the board. Insert the capacitor into the holes on the silk-screened side of the board. Be sure to orient the capacitor correctly.
2. Holding the capacitor in place, turn the board over and bend the two leads slightly outward. Solder the two leads to the foil pattern, and clip off any excess lead lengths.
3. After making sure that there are no solder bridges, check each electrolytic capacitor off of the parts list as you install it.

ELECTROLYTIC CAPACITORS
( ) C1, 33mf at 16V
( ) C2, 33mf at 16V
( ) C5, 33mf at 16V

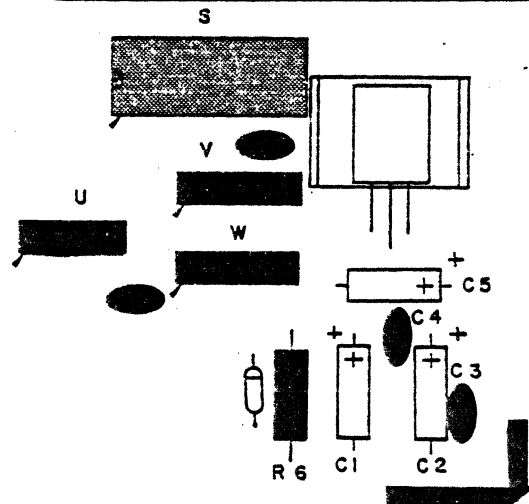

## DIODE INSTALLATION

There is one 5-volt zener diode (silk-screen designation, D1) to be installed on the 88-16MCS.

### NOTE

Diodes are marked with a band to indicate the cathode end. The diode must be oriented so that the banded end corresponds with the band printed on the 88-16MCS. Failure to orient diodes correctly may result in permanent damage to your unit.

Referring to the component layout on this page, install the 5-volt zener diode according to the following instructions.

1. Bend the leads of the diode at right angles to match the correct holes on the board.
2. Be certain that the banded end of the diode matches the band on the silk-screened side of the board.

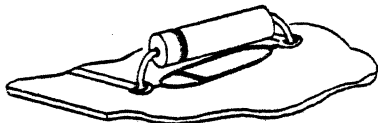

DIODE

3. Insert the diode into the correct holes from the silk-screened side of the board. Turn the board over, and bend the leads slightly outward.
4. Solder the two leads to the foil pattern on the back side of the board. Clip off any excess lead lengths.

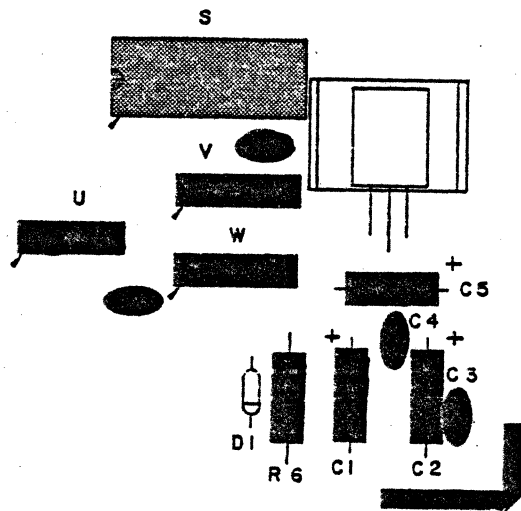



## VOLTAGE REGULATOR INSTALLATION

There are two voltage regulators to be installed on the 88-16MCS.

Referring to the parts chart and the component layout on this page, install the voltage regulator according to the following instructions.

1. Set the voltage regulator in place on the board and align the mounting holes. (See drawing below.)

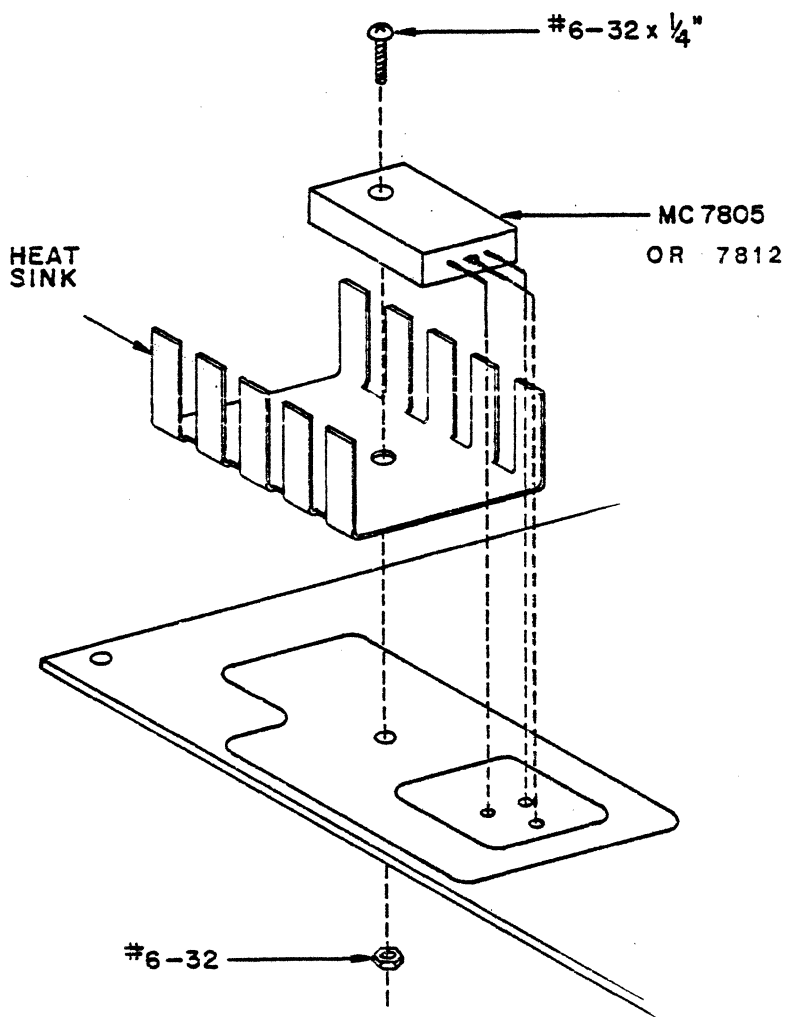

2. Use a pencil to mark the point on each of the three leads where they line up with their respective holes on the board.

3. Using needle-nose pliers, bend each of the three leads at a right angle at the points where you made the pencil marks.

### NOTE

Use heat-sink grease when installing this component. Apply the grease to all surfaces which come in contact with each other.

4. Referring to the preceding drawing, set the regulator and heat sink in place on the silk-screened side of the board. Secure the regulator and heat-sink as shown by the drawing, holding the regulator in place as you tighten the nut.
5. Turn the board over and solder the three leads to the foil pattern on the back side of the board. Be sure not to leave any solder bridges.
6. Clip off any excess lead lengths.

### VOLTAGE REGULATORS

( ) VR1, 12 volts, 7812

( ) VR2, 5 volts, 7805

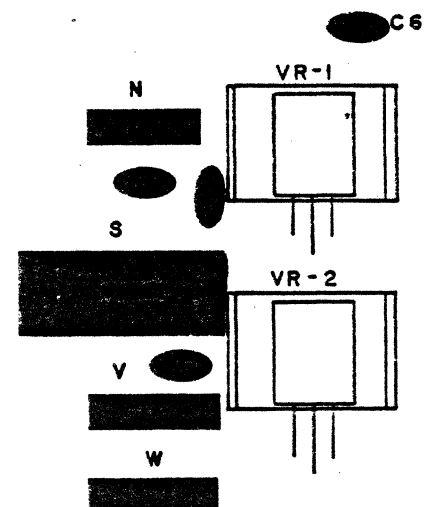

## ADDRESS SWITCH INSTALLATION

There is one address line switch to be installed on the 88-16MCS.

Referring to the component layout on this page, install the address switch according to the following procedure.

1. Remove the switch from its holder. If there are any bent pins, straighten them with a needle-nose pliers.
2. Orient the switch so that the numbers 1, 2, 3 and 4 on the switch line up directly under the corresponding 1, 2, 3 and 4 printed on the board silk-screen. Note the following illustration.

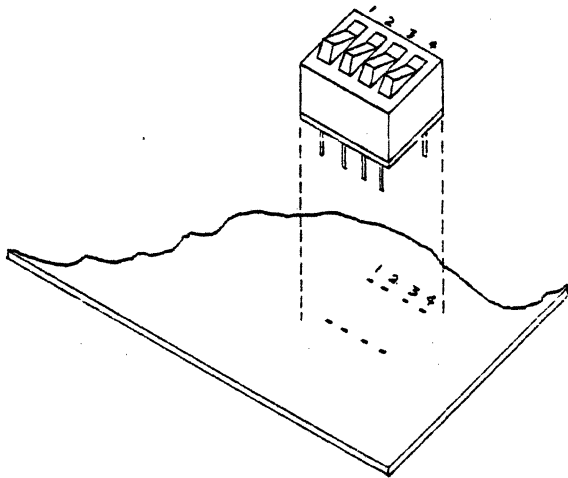

3. Start the pins on one side of the switch into their respective holes on the silk-screened side of the board. DO NOT PUSH THE PINS IN ALL THE WAY. If you have difficulty getting the pins into the holes use the tip of a small screwdriver to guide them.

4. Start the pins on the other side of the switch into their holes in the same manner. When all of the pins have been started, set the IC into place by gently rocking it back and forth until it rests as closely to the board as possible. After you are certain that the switch is straight, tape it in place with a piece of masking tape.
5. Turn the board over and solder each pin to the foil pattern on the back side of the board. Be sure to solder EACH pin, and be careful not to leave any solder bridges.
6. Turn the board over again, and remove the piece of masking tape.

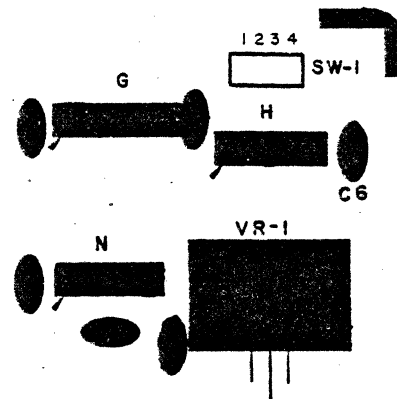

## IC AND BOARD INSTALLATION

ICs A0-A7, B0-B7, C0-C7, D0-D7 and S should be installed now.

1. Review the "MOS IC Special Handling Procedures" on page 5 of the ALTAIR 8800 Assembly Manual. Note, failure to carefully follow the instructions of the "MOS Special Handling Procedures" may result in permanent damage to static-sensitive ICs.
2. Insert the ICs into their sockets on the 88-16MCS. Handle the ICs carefully, and use as little pressure as possible when inserting the ICs. Note that ICs A0-A7, B0-B7, C0-C7 and D0-D7 are 4200s and that the number for IC S is 8212.

Install the edge connector provided with the board according to the procedure described on page 64 in the assembly manual "EXPANDER BOARD 8800 M/BD ASSEMBLY".

Press the 88-16MCS into the edge connector. The board should be oriented so that the silk-screened side faces the right side of the unit viewed from the front panel.

## BOARD SELECTION

Note that the total amount of memory for the 8800 is obtained with four 88-16MCS boards. The four-position switch identifies board selection. Only one of the four switches is used to select a board. The following chart indicates which board to select for the memory location you want.

4-Position Switch	Memory Location
1	0-15K
2	16-31K
3	32-47K
4	48-64K



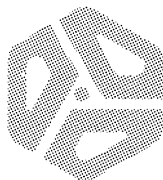

**mits**

2450 Alamo S.E.  
Albuquerque, New Mexico 87106

## USER'S DOCUMENTATION REPORT

In order to improve the quality and usefulness of our publications, user feedback is necessary. Your comments will help us effectively evaluate our documentation.

Please limit your remarks to the document, giving specific page and line references when appropriate. Specific hardware or software questions should be directed to the MITS Customer Service or Software Departments, respectively.

**NAME OF PUBLICATION:** \_\_\_\_\_

**SUGGESTIONS FOR IMPROVEMENT:** \_\_\_\_\_

\_\_\_\_\_  
\_\_\_\_\_  
\_\_\_\_\_

**ERRORS:** \_\_\_\_\_

\_\_\_\_\_  
\_\_\_\_\_  
\_\_\_\_\_

**Name** \_\_\_\_\_ **Date** \_\_\_\_\_

**Organization** \_\_\_\_\_

**Street** \_\_\_\_\_

**City** \_\_\_\_\_ **State** \_\_\_\_\_ **Zip** \_\_\_\_\_

-----  
**First Fold Here** -----

-----  
**Second Fold Here and Staple** -----

=====

No Postage Stamp  
Necessary If Mailed in  
the United States

**BUSINESS REPLY MAIL** =====

First Class Permit No. 2114, Albuquerque, New Mexico

Postage Will be Paid by:

**MITs, Inc.**  
2450 Alamo S.E.  
Albuquerque, New Mexico 87106

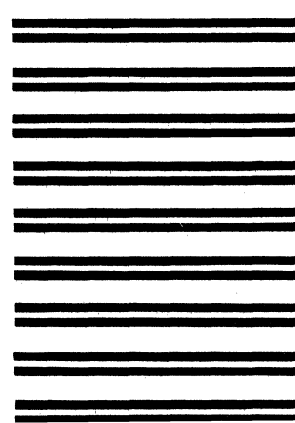

**mits**

**2450 Alamo SE  
Albuquerque, NM 87106**